



32LX774M
43LX774M
55LX774M

Hospital Grade Interactive Pro:Centric[®] TVs

Commercial Mode Setup Guide

Note: Selected features shown in this guide may not be available on all models.

EXPERIENCED INSTALLER

LG First Use Wizard
pages 17 – 18

Custom Master TV Setup
pages 54 – 56

Cloning Procedures
pages 57 – 63

For Customer Support/Service, please call:
1-888-865-3026

The latest product information and documentation is available online at:
www.lg.com/us/business

MODEL and SERIAL NUMBER

The model and serial numbers of this TV are located on the back of the cabinet. For future reference, LG suggests that you record those numbers here:

Model No. _____ Serial No. _____



WARNING:

TO REDUCE THE RISK OF ELECTRIC SHOCK DO NOT REMOVE COVER (OR BACK). NO USER-SERVICEABLE PARTS INSIDE. REFER TO QUALIFIED SERVICE PERSONNEL.



The lightning flash with arrowhead symbol, within an equilateral triangle, is intended to alert the user to the presence of uninsulated “dangerous voltage” within the product’s enclosure that may be of sufficient magnitude to constitute a risk of electric shock to persons.



The exclamation point within an equilateral triangle is intended to alert the user to the presence of important operating and maintenance (servicing) instructions in the literature accompanying the appliance.

WARNING:

TO PREVENT FIRE OR SHOCK HAZARDS, DO NOT EXPOSE THIS PRODUCT TO RAIN OR MOISTURE.

WARNING:

This product contains chemicals known to the State of California to cause cancer and birth defects or other reproductive harm. **Wash hands after handling.**

POWER CORD POLARIZATION:

This product is equipped with a 3-wire grounding-type alternating current power plug. This plug will fit into the power outlet only one way. This is a safety feature. If you are unable to insert the plug fully into the outlet, contact your electrician to replace your obsolete outlet. Do not defeat the safety purpose of the 3-wire grounding-type plug.

NOTE TO CABLE/TV INSTALLER:

This reminder is provided to call the cable TV system installer’s attention to Article 820-40 of the National Electrical Code (U.S.A.). The code provides guidelines for proper grounding and, in particular, specifies that the cable ground shall be connected to the grounding system of the building, as close to the point of the cable entry as practical.

REGULATORY INFORMATION:

This equipment has been tested and found to comply with the limits for a Class B digital device, pursuant to Part 15 of the FCC Rules. These limits are designed to provide reasonable protection against harmful interference when the equipment is operated in a residential installation. This equipment generates, uses and can radiate radio frequency energy and, if not installed and used in accordance with the instruction manual, may cause harmful interference to radio communications. However, there is no guarantee that interference will not occur in a particular installation. If this equipment does cause harmful interference to radio or television reception, which can be determined by turning the equipment off and on, the user is encouraged to try to correct the interference by one or more of the following measures:

- Reorient or relocate the receiving antenna.
- Increase the separation between the equipment and receiver.
- Connect the equipment to an outlet on a circuit different from that to which the receiver is connected.
- Consult the dealer or an experienced radio/TV technician for help.

CAUTION:

Do not attempt to modify this product in any way without written authorization from LG Electronics U.S.A., Inc. Unauthorized modification could void the user’s authority to operate this product.

COMPLIANCE:

The responsible party for this product’s compliance is: LG Electronics U.S.A., Inc.
1000 Sylvan Avenue, Englewood Cliffs, NJ 07632, USA • Phone: 1-201-816-2000

Marketed and Distributed in the United States by LG Electronics U.S.A., Inc.
1000 Sylvan Avenue, Englewood Cliffs, NJ 07632

IMPORTANT SAFETY INSTRUCTIONS

1. Read these instructions.
2. Keep these instructions.
3. Heed all warnings.
4. Follow all instructions.
5. Do not use this apparatus near water.
6. Clean only with dry cloth.
7. Do not block any ventilation openings. Install in accordance with the manufacturer's instructions.
8. Do not install near any heat sources, such as radiators, heat registers, stoves, or other apparatus (including amplifiers) that produce heat.
9. Do not defeat the safety purpose of the polarized or grounding-type plug. A polarized plug has two blades with one wider than the other. A grounding-type plug has two blades and a third grounding prong. The wide blade or the third prong are provided for your safety. If the provided plug does not fit into your outlet, consult an electrician for replacement of the obsolete outlet.
10. Protect the power cord from being walked on or pinched, particularly at plugs, convenience receptacles, and the point where it exits from the apparatus.
11. Only use attachments/accessories specified by the manufacturer.
12. Use only with the cart, stand, tripod, bracket, or table specified by the manufacturer or sold with the apparatus. When a cart is used, use caution when moving the cart/apparatus combination in order to avoid injury from tip-over.



13. Refer all servicing to qualified service personnel. Servicing is required when the apparatus has been damaged in any way, such as power-supply cord or plug is damaged, liquid has been spilled or objects have fallen into the apparatus, the apparatus has been exposed to rain or moisture, does not operate normally, or has been dropped.
14. Never touch this apparatus or antenna during a thunder or lightning storm.
15. Do not apply pressure on or scratch the TV panel during handling. Do not press against the TV panel with your hand or a sharp object such as a nail, pencil, or pen.

16. Power Cord

Caution: Check the TV specifications in the Owner's Manual to determine power requirements.

Periodically examine the cord of your appliance, and if its appearance indicates damage or deterioration, unplug it, discontinue use of the appliance, and have the cord replaced with an exact replacement part by an authorized servicer. Protect the power cord from physical or mechanical abuse, such as twisting, kinking, or pinching or being closed in a door or walked upon. Pay particular attention to plugs, wall outlets, and the point where the cord exits the appliance.

Do not use a damaged or loose power cord. Be sure to grasp the plug when unplugging the power cord. Do not pull on the power cord to unplug the TV.

Do not stick metal objects or any other conductive material into the power cord. Do not touch the end of the power cord while it is plugged in.

17. Overloading

Do not connect too many appliances to the same AC power outlet as this could result in fire or electric shock. Do not overload wall outlets. Overloaded wall outlets, loose or damaged wall outlets, extension cords, frayed power cords, or damaged or cracked wire insulation are dangerous. Any of these conditions could result in fire or electric shock.

18. Outdoor Use/Wet Location



Warning: To reduce the risk of fire or electrical shock, do not expose this product to rain, moisture or other liquids.

Do not touch the TV with wet hands. Do not install this product near flammable objects such as gasoline or candles or expose the TV to direct air conditioning.

Do not expose to dripping or splashing and do not place objects filled with liquids, such as vases, cups, etc., on or over the apparatus (e.g., on shelves above the unit).

19. Grounding

Ensure that you connect the earth ground wire to prevent possible electric shock (i.e., a TV with a three-prong grounded AC plug must be connected to a three-prong grounded AC outlet). If grounding methods are not possible, have a qualified electrician install a separate circuit breaker. Do not try to ground the unit by connecting it to telephone wires, lightning rods, or gas pipes.

20. Disconnect Device

The power plug is the disconnecting device. The power plug must remain readily accessible.

As long as this unit is connected to the AC wall outlet, it is not disconnected from the AC power source even if the unit is turned off.

(Continued on next page)

IMPORTANT SAFETY INSTRUCTIONS

(Continued from previous page)

21. Outdoor Antenna Grounding

If an outside antenna or cable system is connected to the product, follow the precautions below.

An outdoor antenna system should not be located in the vicinity of overhead power lines or other electric light or power circuits or where it can come into contact with such power lines or circuits as death or serious injury can occur.

Be sure the antenna system is grounded so as to provide some protection against voltage surges and built-up static charges.

Article 810 of the National Electrical Code (NEC) in the U.S.A. provides information with respect to proper grounding of the mast and supporting structure, grounding of the lead-in wire to an antenna-discharge unit, size of grounding conductors, location of antenna-discharge unit, connection to grounding electrodes, and requirements for the grounding electrode.

Antenna Grounding According to NEC, ANSI/NFPA 70

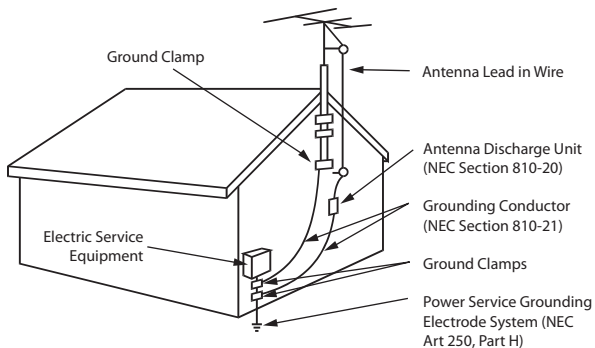

22. Cleaning

When cleaning, unplug the power cord and wipe gently with a soft cloth to prevent scratching. Do not spray water or other liquids directly on the TV as electric shock may occur. Do not clean with chemicals such as alcohol, thinners or benzene.

23. Transporting Product

Make sure the TV is turned off and unplugged and that all cables have been removed. It may take two or more people to carry larger TVs. Do not press against or put stress on the front panel of the TV.

24. Ventilation

Install the TV where there is proper ventilation. Do not install in a confined space such as a bookcase. Do not cover the TV with cloth or other materials (e.g., plastic) while it is plugged in. Do not install in excessively dusty places.

25. If you smell smoke or other odors coming from the TV or hear strange sounds, unplug the power cord, and contact an authorized service center.

26. Keep the product away from direct sunlight.

27. When mounting a TV on the wall, make sure that none of the electrical cabling bears any of the weight of the TV. Install in accordance with the manufacturer's instructions.

28. Do not install this product on a wall if it could be exposed to oil or oil mist. This may damage the product and cause it to fall.

29. Do not allow an impact shock or any objects to fall into the product, and do not drop objects onto the screen.

30. Do not touch the ventilation openings, as they may become hot while the TV is operating. This does not affect the performance of the product or cause defects in the product.

31. Do not use high voltage electrical equipment near the TV (e.g., a bug zapper). This may result in product malfunction.

32. Dot Defect

This panel is an advanced product that contains millions of pixels. In a very few cases, you could see fine dots on the screen while you are viewing the TV. Those dots are deactivated pixels and do not affect the performance and reliability of the TV.

33. Generated Sound

“Cracking”: A cracking noise that occurs while the TV is on or when it is turned off is generated by plastic thermal contraction due to temperature and humidity. This noise is common for products where thermal deformation is required.

Electrical circuit humming/panel buzzing: A low level noise is generated from a high-speed switching circuit, which supplies a large amount of current to operate a product. It varies depending on the product. This generated sound does not affect the performance and reliability of the product.

34. If the TV feels cold to the touch, there may be a small “flicker” when it is turned on. This is normal; there is nothing wrong with the TV. Some minute dot defects may be visible on the screen, appearing as tiny red, green, or blue spots. However, they have no adverse effect on the TV's performance. Avoid touching the screen or holding your finger(s) against it for long periods of time. Doing so may produce some temporary distortion effects on the screen.

35. Displaying a still image for a prolonged period of time may cause image burn-in. Avoid displaying a fixed image on the TV screen for an extended length of time.

Table of Contents

| | | | |
|--|-------|--|---------|
| Safety Warnings | 2 | Before You Begin | 54 |
| Important Safety Instructions | 3–4 | Clonable TV Setup Menu Features | 54 |
| Table of Contents | 5 | Custom Master TV Setup Procedure | 55 |
| Commercial Mode Overview | 7–11 | Cloning Procedures | 57–63 |
| Setup Checklist | 7 | Exporting a Clone File | 57 |
| Pass-through Mode | 7 | Importing a Clone File | 59 |
| FTG Mode | 8 | FTG File Manager Utilities Overview | 64–69 |
| Application Tuning Mode / Pro:Centric Direct | 10 | Creating an FTG Configuration File | 64 |
| Determining the TV Operating Mode | 11 | FTG File Manager Main Screen | 66 |
| Pro:Centric Operation | 12–16 | FTG Channel Map Configuration Utility | 67 |
| Interactive Menu Features | 12 | FTG Channel Map Editor | 68 |
| Interactive Menu Navigation | 12 | FTG Installer Menu Configuration Utility | 69 |
| Pro:Centric Java Application Setup | 14 | IP Environment Setup | 70–78 |
| Pro:Centric HTML Application Setup | 15 | Accessing the IP Environment Menu | 70 |
| LG First Use Wizard | 17–18 | Network Configuration | 70 |
| Before You Begin | 17 | Pro:Centric Setup | 74 |
| Initiate Configuration or Exit the LG First Use Wizard | 18 | Media Share Setup | 76 |
| EZ-Manager Wizard | 19–27 | Pre-loaded Applications | 78 |
| Initiate the EZ-Manager Wizard | 19 | References | |
| TV Configuration Options | 20 | Updating TV/PTC Software using a USB Memory | |
| Zones and Room Number Assignments | 20 | Device | 79–80 |
| Configure Pro:Centric Settings | 22 | Downloading a Splash Screen Image using a USB | |
| USB Configuration | 26 | Memory Device | 81–82 |
| Express Script | 28–37 | Downloading Background Images using a USB | |
| Initiate the Express Script | 28 | Memory Device | 83–84 |
| Configure Pro:Centric Settings | 28 | Power Consumption Settings | 85 |
| Complete the TV Configuration | 31 | TV Aux Input Configuration | 86 |
| Channel Banks Overview | 36 | b-LAN Setup & Overview | 87 |
| Ez Download Utility | 38–41 | FTG Mode via EBL (Local Configuration) | 88 |
| Before You Begin | 38 | Auto Input(s) Sensing Feature | 89 |
| Accessing and Using the Ez Download Utility | 38 | LX774M Hospital Operations | 91–92 |
| Installer Menu | 42–53 | Restoring Factory Defaults on the TV(s) | 93 |
| Accessing the Installer Menu | 42 | Using the TV's Zoning Features | 94–97 |
| Navigating Within the Installer Menu | 43 | Using Media Share Features | 98–102 |
| Modifying Installer Menu Settings | 43 | LX774M Rear and Side Jack Panels | 103 |
| Exiting the Installer Menu and Activating Settings | 43 | External Stereo Speaker Specifications | 104 |
| Detailed Descriptions of Installer Menu Items | 46 | Installer Remote Control Typical Key Functions | 105 |
| Custom Master TV Setup | 54–56 | LG Pro:Centric Patient Remote and Pillow | |
| | | Speaker | 106–107 |

Notes

- Installer Menu content is intended for use primarily by qualified TV electronics technicians.
- Refer to the applicable Owner's Manual and/or Easy Setup Guide for additional information on TV installation, specifications, maintenance, and safety instructions.
- Design and specifications subject to change without prior notice. This document provides examples of typical TV displays. Your displays may vary from those shown in this document.

Table of Contents (Cont.)

| | |
|--|---------|
| Pillow Speaker Setup | 108 |
| VESA Standard TV Mounts | 109 |
| Troubleshooting | 110–112 |
| General Troubleshooting | 110 |
| Commercial Mode Check / FTG Operation Troubleshooting | 111 |
| Channel Banks Setup Troubleshooting | 112 |
| Glossary of Terms | 113 |
| Document Revision History / Open Source Software Notice | 114 |
| Back Cover | 115 |

This document describes how to set up LX774M Pro:Centric® TVs for Commercial Mode operation. LG commercial TV functionality is based on “ownership” of the Channel Map; that is, the Channel Map resides in the TV’s CPU, Protocol Translation Controller (PTC), or embedded *b*-LAN™ (EBL) module, or it resides in a Pro:Centric application or an external device from the solution provider.

These TV models support several different operational modes: LG’s Free-To-Guest (FTG) Mode via the TV CPU, FTG Mode via the TV’s EBL module, Application Tuning Mode (ATM) with Pro:Centric application, or Pass-through Mode (default). When in Pass-through Mode, these TV models can also be externally controlled via the Multiple Protocol Interface (MPI).

Setup Checklist

Note: This document provides information specific to Commercial Mode operation. Refer to the Owner’s Manual and/or Easy Setup Guide for information on TV installation and hardware and cable connections.

Installation

- ___ Unpack TV and all accessories.
 - ___ Install batteries in the Installer Remote.
 - ___ Install TV on VESA mount or stand.
- Note:** It may be advisable to make all cable connections before installing on VESA mount or stand, as appropriate.

Cable Connections

- ___ Make all rear jack panel connections, as appropriate.

Commercial Mode Setup

- ___ Complete appropriate procedures as described in this document for Commercial Mode operation.

Hardware Connections

- ___ Install any additional hardware as appropriate to your institution, LAN, etc.

Pass-through Mode

This mode allows you to configure individual TVs for Pro:Centric and/or FTG Mode via CPU operation or create a Master TV Setup for cloning purposes. This mode also allows external control via the GAME CONTROL/MPI port on the TV rear jack panel.

There are three methods for configuring individual TVs that are currently in Pass-through Mode: using one of the two LG First Use Wizard options or using the Custom Master TV Setup procedure.

LG First Use Wizard Configuration

When the TV is in a factory default state, the LG First Use Wizard provides the following two configuration options. See “LG First Use Wizard” on pages 17 to 18 for further information.

- The EZ-Manager Wizard provides automated or manual options for configuring Pro:Centric operation and also provides the option to configure the TV using a USB memory device.
- The Express Script provides streamlined configuration of the TV for FTG Mode via CPU operation with Hospital Mode features (including pillow speaker setup) and also provides the option to configure the TV for Pro:Centric operation.

Custom Master TV Setup

Unlike the guided process above, the Custom Master TV Setup procedure enables you to create a customized Master TV Setup for cloning purposes for TVs that are to remain in Pass-through Mode. Use the Installer Remote to configure Installer Menu items as required for TV operation and set up TV features (Picture, Sound, Channels, etc.). See “Custom Master TV Setup” on pages 54 to 56 for detailed information.

Commercial Mode Overview (Cont.)

Installer Menu

To create a Master TV Setup, you will need to know how to access the commercial controller (PTC) Installer Menu and make changes to the default values as required. If necessary, familiarize yourself with the Installer Menu and how to make and save changes. See pages 42 to 53 for information on accessing the Installer Menu and for detailed descriptions of the Installer Menu items.

TV Setup Menus

On-screen setup menus control the features of the TV. Use the Installer Remote to access the TV setup menus, and set the TV features to the desired configuration for the end user.

Cloning

Cloning refers to the process of using a Master TV Setup to configure a Target TV. The Master TV's clonable setup menu features should be configured as part of the Master TV Setup. If there are features in the Master TV's setup—channel icons or labels, digital font options, etc.—that are not set or that are set incorrectly, those features also will not be set or will be set incorrectly in the Target TVs. See pages 57 to 63 for detailed information on Clone (.tlx) files and cloning requirements and procedures.

External MPI Control

To control the TV using an external MPI control device, you must use the TV's GAME CONTROL/MPI port for communication purposes. In these TVs, Installer Menu item 118 POWER SAVINGS controls the power circuitry for both the embedded b-LAN module and the GAME CONTROL/MPI port; therefore, to ensure that the GAME CONTROL/MPI port circuitry is powered, thus enabling MPI communication, Installer Menu item 118 POWER SAVINGS must be set appropriately. See Installer Menu item descriptions as well as Reference section, "b-LAN Setup & Overview," for further information.

Note: These TV models are not equipped with MPI card slots.

FTG Mode

In this mode, an FTG Channel Map enables the decryption of each Pro:Idiom[®] encrypted channel. The FTG Channel Map also provides logical channel mapping of physical RF channels (digital and analog), IP streams, and Aux inputs. The method for creating the FTG Channel Map is ultimately determined by which element of the TV will "own" the FTG Channel Map—the CPU or the EBL.

For these TV models, there are two FTG Modes—FTG Mode via CPU and FTG Mode via EBL—which are separate and distinct FTG Modes of operation, each with its own unique advantages and requirements, as outlined on the following page.

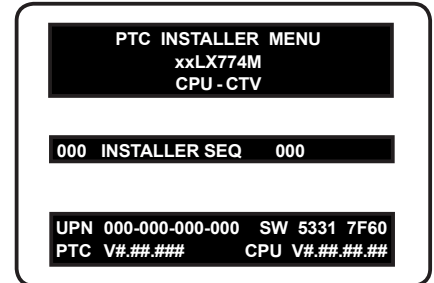

Typical Installer Menu

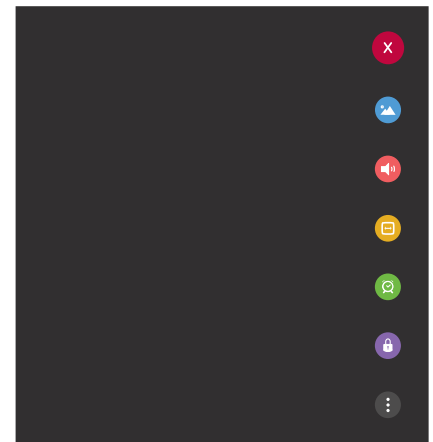

TV Setup Menus (Quick Settings)

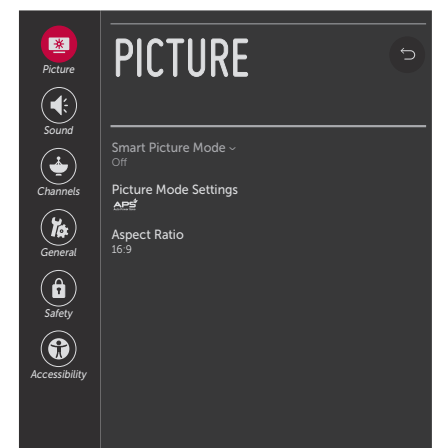

TV Setup Menus (Advanced Settings)

When the TV CPU is configured with an FTG Channel Map, the CPU controls and restricts the tuning operation of the TV, and when the EBL is configured with an FTG Channel Map, the EBL controls and restricts the tuning operation of the TV. In these models, depending on the types of channels included in the FTG Channel Map, FTG Mode via CPU also provides the option to select either logical or physical tuning (see notes at the top of the following page) during configuration. You must determine which element of the TV will own the FTG Channel Map before you can begin configuration.

FTG Mode via CPU

This mode provides the following features:

- Logical or physical channel tuning of physical RF channels and Aux inputs.
- Logical channel tuning of IP streams.
- Mapping of RF channels with minor (program) numbers up to 999.
- FTG Channel Map of up to 600 channels.
- Start Channel set for RF, Aux input, or IP delivered content.
- Pro:Centric data delivery over RF or IP.
- TV Zoning (including channel restrictions by Zone) and Wi-Fi Zoning options for location-specific configuration.

LG's FTG File Manager PC software enables you to create an FTG Configuration (.tlx) file, which may be used to configure the CPU for FTG Mode. You can also create a Clone (.tlx) file from a Master TV Setup that may be used to configure the CPU for FTG Mode.

Note: TV Zoning and Wi-Fi Zoning features are supported via ".tlx" file. See Reference section, "Using the TV's Zoning Features," for further information.

In this mode, the CPU is the owner of the FTG Channel Map and must be configured with an FTG Channel Map and FTG Installer Menu settings using one of the following processes:

- Local: Configure an individual LX774M TV via its USB port using a USB memory device / ".tlx" file. The file may be either a Clone file (see "Cloning Procedures" on pages 57 to 63) or an FTG Configuration file (see "FTG File Manager Utilities Overview" on pages 64 to 69).
- Remote: Configure all LX774M TVs at the site using a Pro:Centric server head end device (Example: PCS200S). Refer to the **Pro:Centric Server Admin Client User Guide** for further information.

FTG Mode via EBL

This mode provides the following features:

- Logical channel tuning of physical RF channels and Aux inputs.
- Mapping of RF channels with minor (program) numbers up to 255.
- FTG Channel Map of up to 141 logical channels.
- Start Channel set for RF or Aux input delivered content.
- Pro:Centric data delivery over RF.

LG's FTG Device Configuration Application PC software is required to configure the EBL. In this mode, the EBL is the owner of the FTG Channel Map and must be configured with an FTG Channel Map and FTG Installer Menu settings using one of the following processes:

- Local: Configure an individual LX774M TV's EBL via its TV-LINK CFG jack using a direct PC-to-TV (EBL) connection and the FTG Device Configuration Application. See Reference section, "FTG Mode via EBL (Local Configuration)," for information on the "Write" process for an FTG Channel Map and FTG Installer Menu settings.
- Remote: Configure all LX774M TV EBLs at the site using a Free-To-Guest Management Appliance (FMA) head end device (Example: FMA-LG102). Refer to the **Free-To-Guest (FTG) Device Configuration Application User Guide** and/or the Installation & Configuration Guide for the FMA device for further information.

Commercial Mode Overview (Cont.)

Note: Logical channel mapping of physical RF channels eliminates dash tuning; for example, physical 19-3 can be mapped to logical channel 9. It also allows physical RF channels, IP streams, and Aux inputs to be listed in any order, not only in physical numeric ascending order. Physical channel tuning requires that you include the dash when direct entering RF channel numbers and Aux inputs (the latter designated by 130-0 through 137-0).

Note: Physical channel tuning is not available when IP channels are included in the FTG Channel Map.

While the TV is in FTG Mode:

- Users can still access the Installer Menu using an LG Installer Remote; however, all Installer Menu items will be read-only.
- FTG Mode via CPU configuration changes must be made using a “.tlx” file (typically edited in the FTG File Manager), while FTG Mode via EBL configuration changes must be made using the FTG Device Configuration Application. FTG Channel Map Configuration and FTG Installer Menu Configuration utilities in both PC applications enable you to make changes, respectively, to the FTG Channel Map and FTG Installer Menu settings as necessary. Based on the initial method used to configure the TV for FTG Mode operation (via CPU or EBL), all subsequent changes must be transferred to either the TV CPU or the EBL via a process that is in accordance or compatible with that method (see information on local configuration in this document or refer to documentation for the head end device/server for information on remote management).
- If it becomes necessary to restore the TV to Pass-through Mode, there are several options that will enable you to do so. See Reference section, “Restoring Factory Defaults on the TV(s),” for further information.

Pages 64 to 69 provide overviews of the utilities that comprise the FTG File Manager. Refer to the **Free-To-Guest (FTG) File Manager User Guide** for further information on the FTG File Manager. Refer to the **Free-To-Guest (FTG) Device Configuration Application User Guide** for information on the FTG Device Configuration Application.

Remote Management in FTG Mode

When the TV is configured for FTG Mode via CPU, remote management of the FTG Channel Map and FTG Installer Menu settings is provided by a Pro:Centric server, via a Clone/Configuration (.tlx) file loaded on the Pro:Centric Admin Client. See the **Pro:Centric Server Admin Client User Guide** for further information.

When the TV is configured for FTG Mode via EBL, the *b*-LAN module, which is internal to the TV, allows hospital/institution head end equipment (for example, an FMA-LG102) with *b*-LAN technology to provide remote management of the FTG Channel Map and FTG Installer Menu settings. See Reference section, “*b*-LAN Setup & Overview,” for further information.

Application Tuning Mode / Pro:Centric Direct

In Application Tuning Mode, the TV’s Channel Map resides in an application, such as LG’s Pro:Centric Direct HTML application. With Pro:Centric Direct, the Channel Map is created in the Pro:Centric server’s Admin Client web editor, and the tuning operation of the TV is controlled and restricted based on this Pro:Centric Direct Channel Map.

Application Tuning Mode with the Pro:Centric Direct HTML application provides the following features:

- Decryption of each Pro:Idiom[®] encrypted channel.
- Logical channel tuning of physical RF channels (digital and analog) and IP streams.
- Mapping of RF channels with minor (program) numbers up to 999.

Commercial Mode Overview (Cont.)

- Start Channel set for RF or IP delivered content.
- Pro:Centric data delivery over RF or IP.
- TV Zoning (Installer Menu items only) and Wi-Fi Zoning options for location-specific configuration.

You must use the Pro:Centric Direct Admin Client / Channel Map configuration utility to create the Pro:Centric Direct Channel Map, define channel attributes, and set the Start Channel. Refer to the **Pro:Centric Direct Admin Client User Guide** for further information.

Note: TV Zoning and Wi-Fi Zoning features are supported via “.tlx” file—typically a Clone (.tlx) file that has been created from a Master TV Setup. See Reference section, “Using the TV’s Zoning Features,” for further information.

While the TV is in Application Tuning Mode:

- Users can still access the Installer Menu using an LG Installer Remote; however, all Installer Menu items will be read-only.
- While it is possible to update a TV’s Installer Menu and/or Setup Menu settings locally using a USB memory device / Clone (.tlx) file, any Pro:Centric Direct configuration changes are typically made remotely via the Pro:Centric server / Pro:Centric Direct Admin Client. The Admin Client’s Channel Map configuration utility enables you to create and edit the Pro:Centric Direct Channel Map, while the TV Configuration utility (in conjunction with a Clone [.tlx] file loaded on a server carousel) enables you to make changes to TV Installer Menu and/or Setup Menu settings.
- If it becomes necessary to restore the TV to Pass-through Mode, it is possible to do so. See Reference section, “Restoring Factory Defaults on the TV(s),” for further information.

Refer to the **Pro:Centric Direct Admin Client User Guide** for further information on configuration and management via the Pro:Centric Direct Admin Client.

Determining the TV Operating Mode

To determine the operating mode of the TV, press **MENU** on the Installer Remote. The menu displayed depends on the operating mode. See examples below.

If the Function Menu appears, the TV is in a mode (FTG, ATM, PPV, etc.) that does not allow the end user to change the fundamental TV setup. If the TV setup menus (Quick Settings) appear, the TV is in Pass-through Mode.

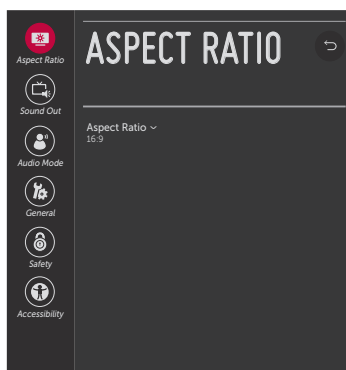

Function Menu
Indicates the TV is not in Pass-through Mode. While the TV is in this mode, Installer Menu settings can be accessed as read-only.

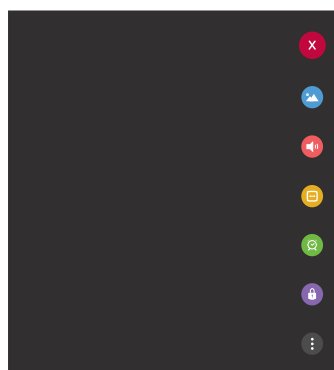

TV Setup Menus
Shows that the TV is in Pass-through Mode.

Pro:Centric Operation

These TV models support LG's Pro:Centric Java application, as well as the Pro:Centric Direct HTML application. Only one application may be implemented at a time. The following sections provide an overview of the application features and functionality.

Interactive Menu Features

Both the Pro:Centric Java application and the Pro:Centric Direct HTML application enable patients and visitors to locate and select television entertainment, check the daily weather, view hospital and surrounding amenities, etc. via custom portal interactive menus. The Pro:Centric Java application provides multiple templates for portal interactive menus, while the Pro:Centric Direct HTML application, in addition to providing multiple templates for portal interactive menus, also enables you to custom-create portal and application content.

Pro:Centric application features include:

- Portal and information screens/pages (including a "Welcome" page) that include branding logos.
- An optional customized user interface (custom "skins").
- Billboards and points-of-interest maps, which can be customized to focus on hospital amenities, local attractions and businesses, hotels, restaurants, news, events, etc.
- An optional Weather billboard that includes a local radar map, current conditions, and a four day forecast.
- An interactive channel guide that provides a channel list with channel icons. An electronic program guide (EPG) is an optional feature that displays up to three days of programming information viewable by channel and time.
- Video spooling that enables the hospital to deliver a video file to patient and visitor TVs for promotion and information purposes.

In addition to the those indicated above, the Pro:Centric Direct HTML application also offers the following features:

- Optional messaging features, including notices, ticker text, and ad banners.
- Additional media support, specifically music accompaniment, for portal displays.
- An optional flight information display.

For each Pro:Centric application, an Admin Client web editor/content wizard is provided for customer configuration of portal content. The Pro:Centric Direct Admin Client features the Pro:Centric Direct Project Editor, which provides design tools (including templates) that enable customization of all portal pages. Please contact your LG service representative for further information.

Note: Customized content is typically defined by the service integrator and/or hospital administrators. LG does not provide hospital-specific content.

Interactive Menu Navigation

LG's Pro:Centric pillow speaker provides access to both interactive menus and regular TV features. Press **PORTAL** on the Pro:Centric pillow speaker to access the interactive menus.

Interactive menu options may vary, depending on Pro:Centric features enabled for the site and/or customized content. The following examples show typical portal interactive menus.

Example: Pro:Centric Java Application Portal



Example: Pro:Centric Direct HTML Application Portal



Pro:Centric Operation (Cont.)

Pro:Centric Java Application Setup

The Pro:Centric Java application operates in conjunction with FTG and PPV Modes. This section provides an overview of the setup required for the Pro:Centric features. Administration and management options for the Pro:Centric server are described in detail in the *Pro:Centric Server Admin Client User Guide*. This document describes only those settings that must be specified on the TVs to enable Pro:Centric remote management and/or the Pro:Centric Java application.

- Remote management (TV E-Z Installation): The Pro:Centric Admin Client provides remote management facilities for downloading splash screen image and software/firmware updates as well as facilities for downloading a Clone/Configuration (.tlx) file for FTG Mode via CPU configuration.
- Pro:Centric Java application: The application comprises the Pro:Centric interactive menus/features described on page 12. Pro:Centric application settings are managed via the Pro:Centric Admin Client for the Java application.

The Pro:Centric remote management facilities and application download are based on Installer Menu item settings that are used to set up the TV's Pro:Centric features. The Installer Menu / Pro:Centric server settings can be configured using one of the methods described below.

Note: If using a Pro:Centric pillow speaker, also set Installer Menu item 027 HOSPITAL MODE to the required value.

TV in Factory Default State

When the TV is in a factory default state, LG's First Use Wizard (see pages 17 to 18) provides automated or manual options for configuring the Pro:Centric server settings. The EZ-Manager branch of the First Use Wizard also provides a USB configuration option that enables you to configure a TV for FTG Mode via CPU using a Clone/Configuration (.tlx) file stored on a USB memory device. The ".tlx" file incorporates FTG Installer Menu settings, including Installer Menu items 098 PRO:CENTRIC and 119 DATA CHANNEL, which are used to set up the TV's Pro:Centric features.

Note: If Pro:Centric data delivery will be over IP, there is a Domain Name System (DNS) server at the site, and you intend to use the EZ-Manager Wizard to set up the TV, you can create a DNS entry "procentric.local" for the Pro:Centric server that will enable automated Pro:Centric IP configuration via the EZ-Manager. If there is no DNS entry for procentric.local, you will need to manually enter the Pro:Centric server IP address and port number during configuration.

TV in Pass-through Mode

If the EZ-Manager Wizard has been exited and the TV is in Pass-through Mode, either:

- Set Installer Menu items 098 PRO:CENTRIC and 119 DATA CHANNEL to the appropriate values. See Installer Menu information on pages 42 to 53 for further details. Also, as necessary, refer to "Custom Master TV Setup" on pages 54 to 56 and/or cloning information on pages 57 to 63.
- Configure the appropriate Pro:Centric server settings in the IP Environment / Pro:Centric Menu. You must use this option, in particular, if you wish to configure IP settings for the Pro:Centric server. See "Accessing the IP Environment Menu" on page 70 and "Pro:Centric Setup" on pages 74 to 76 for further information.

Note: When the TV is in either Pass-through Mode or FTG Mode via CPU, you can also leave Installer Menu item 119 DATA CHANNEL set to its default value (255) to enable the TV's Data Channel Auto Search feature to set the DATA CHANNEL value. See item 119 description on page 52 for additional information.

TV in FTG Mode

If the TV is already in FTG Mode (via CPU or EBL), use the appropriate FTG application to update Installer Menu items #98 Pro:Centric and #119 Data Channel (along with their affiliated fields). Then, transfer the FTG Installer Menu settings to the TV in accordance with the FTG Mode of configuration. Refer to the FTG Mode overview on pages 8 to 10 for further information on FTG Mode operation and configuration. Also—for FTG Mode via CPU only—see note above regarding the option to use the TV's Data Channel Auto Search feature to set the DATA CHANNEL value.

Pro:Centric Direct HTML Application Setup

The Pro:Centric Direct HTML application operates only in Application Tuning Mode (ATM). This section provides an overview of the setup required for the Pro:Centric Direct features. Administration and management options for the Pro:Centric server are described in detail in the **Pro:Centric Direct Admin Client User Guide**. This document describes only those settings that must be specified on the TVs to enable Pro:Centric remote management and/or the Pro:Centric Direct HTML application.

- Remote management (TV E-Z Installation): The Pro:Centric Direct Admin Client provides remote management facilities for downloading splash screen image and software/firmware updates as well as facilities for downloading Installer Menu configuration updates via Clone (.tx) file to the TVs at the site/institution.

Note: The Pro:Centric Direct Channel Map is created and maintained in the Pro:Centric Direct Admin Client. Thus, any Clone file that is loaded on the server for remote configuration may only contain Installer Menu and/or Setup Menu profiles.

- Pro:Centric Direct HTML application: The application comprises the Pro:Centric interactive menus/features described on page 12. Pro:Centric Direct application settings are managed via the Pro:Centric Direct Admin Client.

The Pro:Centric remote management facilities and application download are based on Installer Menu item settings that are used to set up the TV's Pro:Centric features. The Installer Menu / Pro:Centric server settings can be configured using one of the methods described below.

TV in Factory Default State

When the TV is in a factory default state, LG's First Use Wizard (see pages 17 to 18) provides automated or manual options for configuring the Pro:Centric server settings. The EZ-Manager branch of the First Use Wizard also provides a USB configuration option that enables you to configure the TV's Installer Menu settings using a Clone/Configuration (.tx) file stored on a USB memory device. Installer Menu items 098 PRO:CENTRIC and 119 DATA CHANNEL are used to set up the TV's Pro:Centric features.

Note: If Pro:Centric data delivery will be over IP, there is a Domain Name System (DNS) server at the site, and you intend to use the EZ-Manager Wizard to set up the TV, you can create a "procentric.local" DNS entry for the Pro:Centric server that will enable automated Pro:Centric IP configuration via the EZ-Manager. If there is no DNS entry for procentric.local, you will need to manually enter the Pro:Centric server IP address and port number during configuration.

TV in Pass-through Mode

If the EZ-Manager Wizard has been exited and the TV is in Pass-through Mode, either:

- Set Installer Menu items 098 PRO:CENTRIC and 119 DATA CHANNEL to the appropriate values. See Installer Menu information on pages 42 to 53 for further details. Also, as necessary, refer to "Custom Master TV Setup" on pages 54 to 56 and/or cloning information on pages 57 to 63.

Pro:Centric Operation (Cont.)

- Configure the appropriate Pro:Centric server settings in the IP Environment / Pro:Centric Menu. You must use this option, in particular, if you wish to configure IP settings for the Pro:Centric server. See “Accessing the IP Environment Menu” on page 70 and “Pro:Centric Setup” on pages 74 to 76 for further information.

Note: When the TV is in either Pass-through Mode or Application Tuning Mode, you can also leave Installer Menu item 119 DATA CHANNEL set to its default value (255) to enable the TV's Data Channel Auto Search feature to set the DATA CHANNEL value. See item 119 description on page 52 for additional information.

TV in Application Tuning Mode

If the TV is already in Application Tuning Mode, use a Master TV of the same model to create and export a Clone (.tix) file with the desired settings for Installer Menu items 098 PRO:CENTRIC and 119 DATA CHANNEL. Then, transfer (import) the Clone file to the Target TV. Refer to the Application Tuning Mode / Pro:Centric Direct overview on pages 10 to 11 for further information on Pro:Centric Direct operation and configuration. To transfer the Clone file remotely, use the appropriate utilities in the Pro:Centric Direct Admin Client to upload the Clone file to the Pro:Centric server and set up its distribution to the Target TV(s) at the site. See also note above regarding the option to use the TV's Data Channel Auto Search feature to set the DATA CHANNEL value.

Note: After it is turned ON, the TV begins an initialization process, and it may take several minutes for the LG First Use Wizard to appear.

The LG First Use Wizard, comprising EZ-Manager Wizard and Express Script configuration options, will appear on the screen each time the TV is turned ON, until one of its configuration methods has been completed or the wizard is exited. Use the Installer Remote to make selections and complete each step.

- The primary purpose of the EZ-Manager Wizard is to guide you through the process (automated or manual) of configuring the essential Installer Menu items for Pro:Centric operation. However, while intended primarily for Pro:Centric-related configuration, the EZ-Manager Wizard also offers Zoning options. LX774M TVs support the TV Zoning and Wi-Fi Zoning features, both of which enable location-specific settings (see Reference section, “Using the TV’s Zoning Features,” for further information). The EZ-Manager Wizard enables you to set the TV Zone # and/or the Wi-Fi Zone # in the TV as part of the configuration process.

The EZ-Manager Wizard also enables you to access the TV Manager / USB download options as part of the configuration process, if desired, to perform USB configuration and/or update functions.

- The Express Script guides you through the process of configuring the TV for FTG Mode via CPU operation with Hospital Mode features. This includes setting up the pillow speaker, as required, as well as setting up channel banks (up to four) for tiered channel programming. The Express Script also enables you to configure the Pro:Centric settings on the TV.

Note that the Express Script uses the TV’s standard RF Auto Tuning feature to create the TV’s channel lineup; IP channels are not supported.

 **Caution: Do NOT unplug the TV power cord or remove the antenna cable or, if applicable, the LAN cable during the configuration process, as doing so will interrupt the current step and may corrupt the configuration data.**

 **Note: If you do not intend to complete the Express Script, but you wish to enable Hospital Mode (pillow speaker functionality and also channel banks), you must set Installer Menu item 027 HOSPITAL MODE appropriately. See the “Installer Menu” section of this document for further information.**

Before You Begin

- If you plan to create a customized Master TV Setup using the procedure described on pages 54 to 56, be sure to exit the LG First Use Wizard in order to avoid setup conflicts or setting modes that may cause the TV to malfunction or restrict the custom setup procedure. See also “Initiate Configuration or Exit the LG First Use Wizard” on the following page.
- If it has been completed or exited and therefore does not display, the First Use Wizard can be reactivated; however, this requires that you restore the TV to a factory default condition. See Reference section, “Restoring Factory Defaults on the TV(s),” for further information.
- If you would like to enable the SoftAP and/or DIAL Media Share features or select pre-loaded/ Smart Launcher applications on a TV that will eventually be configured for FTG Mode, you will need to use the IP Environment Menu to do so before the TV is configured for FTG Mode. Refer to “IP Environment Setup” on pages 70 to 78 for information on the IP Environment Menu. See also “Custom Master TV Setup” on pages 54 to 56.

LG First Use Wizard (Cont.)

Initiate Configuration or Exit the LG First Use Wizard

The Welcome screen provides a brief introduction to the LG First Use Wizard.

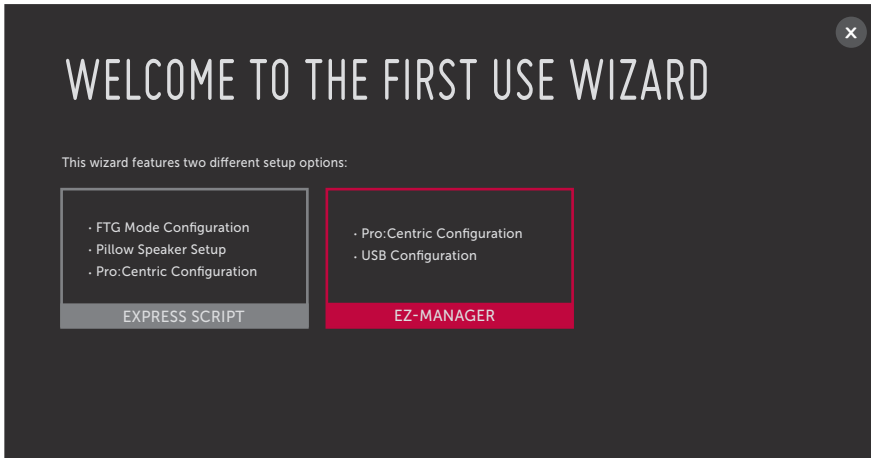

Note: Once you proceed with one of the configuration options, it is not possible to return to the First Use Wizard Welcome screen; however, if you simply wish to exit the EZ-Manager Wizard or Express Script (depending on your selection from the First Use Wizard Welcome screen), you can do so by selecting the **✕** button from the subsequent screen(s).

From the Welcome screen, you have the following options:

- To proceed with the EZ-Manager Wizard, use the arrow keys on the Installer Remote to select/highlight **EZ-MANAGER**, and then press **OK**. Then, continue to the “EZ-Manager Wizard” section on pages 19 to 27.
- To proceed with the Express Script, use the arrow keys on the Installer Remote to select/highlight **EXPRESS SCRIPT**, and then press **OK**. Then, continue to the “Express Script” section on pages 28 to 37.
- To exit the First Use Wizard, use the arrow keys on the Installer Remote to select/highlight the **✕** button at the top right of the screen, and then press **OK**. In the confirmation pop-up window, select **EXIT**, and then press **OK** once more on the Installer Remote.

Note: Both the EZ-Manager Wizard and the Express Script enable you to configure Pro:Centric settings on this TV, even if you do not intend to configure any of the additional settings available. After you configure the Pro:Centric settings, you will have the option to exit without completing the remainder of the EZ-Manager Wizard or Express Script (as applicable), if desired.

Note: If you exit the First Use Wizard from this Welcome screen, no configuration will be performed and all Installer Menu items will retain their default values, including Installer Menu item 119 DATA CHANNEL. The default DATA CHANNEL setting (255) means that the Pro:Centric remote management feature on this TV will be activated if a Pro:Centric server is installed and the Data Channel value is set during a Data Channel Auto Search (see item 119 description on page 52 for additional information). If you actually would like to disable the Pro:Centric feature, both the EZ-Manager Wizard and the Express Script provide an option to do so.

Initiate the EZ-Manager Wizard

After you select the “EZ-Manager” option from the First Use Wizard Welcome screen, an EZ-Manager Welcome screen provides a brief introduction to the EZ-Manager Wizard.

Note: Each EZ-Manager Wizard step is allotted a time frame after which the wizard proceeds without user interaction. If the Pro:Centric server is configured on the system and if no location-specific settings are required in the TV, for example, TV Zone, Wi-Fi Zone, Label, and/or Room Number settings, from this point, the wizard can proceed through each of the configuration steps with no further user interaction.

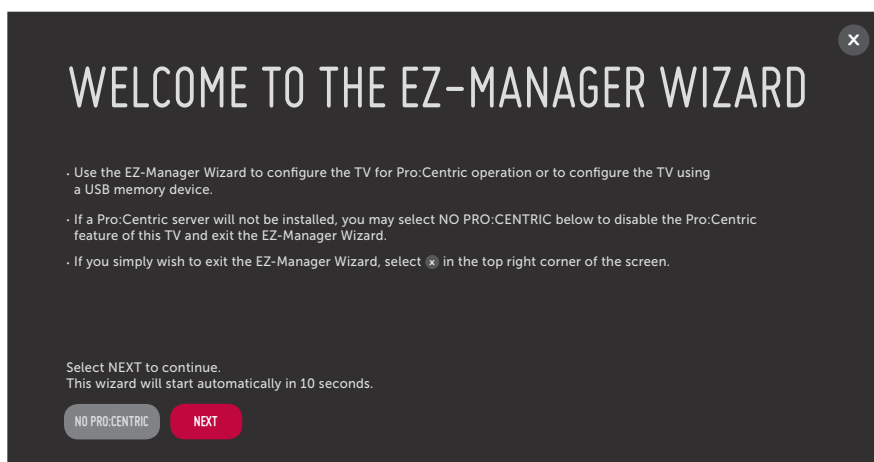

Note: If there is no user action in this screen within 10 seconds, the wizard will proceed to the next configuration step. Once the wizard has proceeded, it is not possible to return to the EZ-Manager Welcome screen; however, if you simply wish to exit the wizard, you can do so by selecting the **X** button from the subsequent screen(s).

From the EZ-Manager Welcome screen, you have the following options:

- To proceed with the EZ-Manager Wizard, use the arrow keys on the Installer Remote to select **NEXT**, and then press **OK**. Then, continue to the “TV Configuration Options” section on the following page.
- To exit the EZ-Manager Wizard, but retain the use of the Pro:Centric remote management feature on this TV (i.e., Installer Menu item 119 DATA CHANNEL set to 255) in the future, use the arrow keys on the Installer Remote to select/highlight the **X** button, and then press **OK**. In the confirmation pop-up window, select **EXIT**, and then press **OK** once more on the Installer Remote.
- If you do not intend to install a Pro:Centric server on this system and you do not wish to use the wizard’s Zoning or USB configuration options, exit the wizard as follows: Use the arrow keys on the Installer Remote to select **NO PRO:CENTRIC**, and then press **OK**. This will disable the Pro:Centric feature of this TV (i.e., Installer Menu item 119 DATA CHANNEL will be set to 0) and exit the wizard. In the confirmation pop-up window, select **EXIT**, and then press **OK** once more on the Installer Remote.

EZ-Manager Wizard (Cont.)

TV Configuration Options

From the TV Configuration Options screen, you can choose how to proceed with the configuration of this TV (assuming you do not opt to exit the wizard, which you may also do at any time).



Note: If you intend to use the Zoning feature(s) on the TV for location-specific configuration purposes, select the “Zones & Room Number” option from this screen and assign the appropriate TV Zone # and/or the Wi-Fi Zone # in the TV BEFORE you continue with additional configuration.

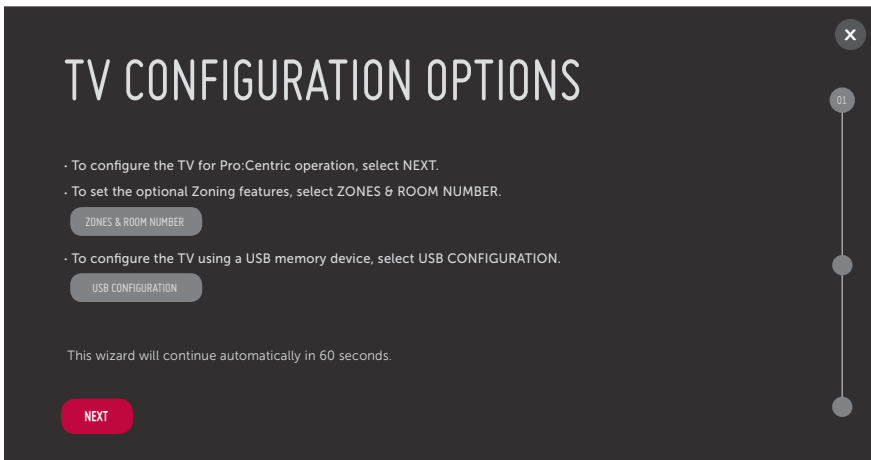

Note: If there is no user action in this screen within one minute, the wizard will automatically continue to the next configuration step.

Use the Left/Right arrow keys on the Installer Remote to navigate between options on this screen. Each time you select/highlight one of the following options, the screen text and fields will change in accordance with your selection.

- To continue with Pro:Centric configuration, select **NEXT** (default) and press **OK** on the Installer Remote. Refer to “Configure Pro:Centric Settings” on pages 22 to 26 for additional information.
- To set the Zoning feature(s) on the TV, select **ZONES & ROOM NUMBER**. See “Zones and Room Number Assignments” below for further information.
- To access the TV Manager / USB download options, select **USB CONFIGURATION**. See “USB Configuration” on pages 26 to 27 for further information.

Note: If you choose to exit the EZ-Manager Wizard from this point on, you will have the option to save any settings made by selecting **SAVE & EXIT** in the exit confirmation pop-up window. Or, you can exit the wizard without saving any settings by simply selecting **EXIT** in the confirmation pop-up window.

Zones and Room Number Assignments

You may complete one or more of the fields in the Zones, Label, and Room Number screen or leave them at their default settings (TV Zone and Wi-Fi Zone) or blank (Label and Room Number), as desired. However, if you intend to use either of the Zoning features—TV Zoning and/or Wi-Fi Zoning—on this TV, you **MUST** specify the appropriate values in the TV Zone and/or Wi-Fi Zone fields as described on the following page. See also Reference section, “Using the TV’s Zoning Features,” for further information.

Note: Zoning features are only applicable for TVs that will be configured using a “.tlx” file (local or remote configuration).

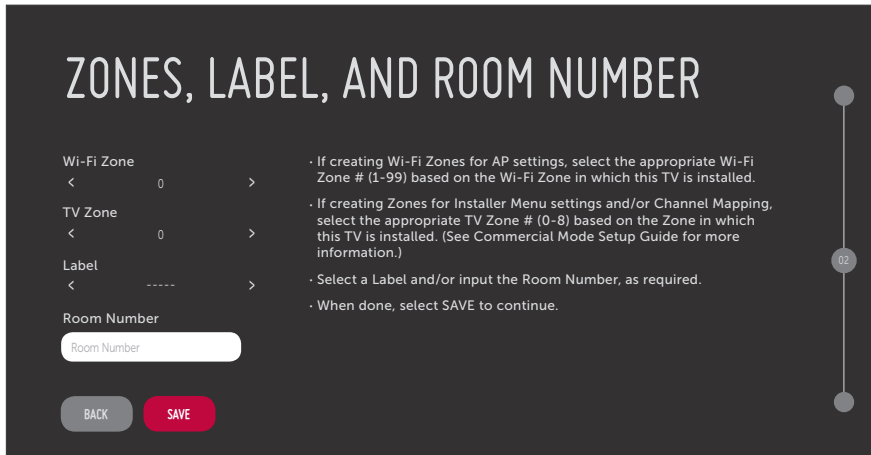

- Complete the appropriate field(s) as described below. Use the Up/Down arrow keys on the Installer Remote to navigate between each of the fields.
 - Wi-Fi Zone:** Enables you to set a Wi-Fi Zone # so that the TV can be configured with a particular access point’s login data for wireless networking. Login data (i.e., SSID, security type, and security key) may be provided in a Clone/Configuration (.tlx) file.
To assign a Wi-Fi Zone, navigate to the Wi-Fi Zone field at the top left of the screen, and use the Left/Right arrow keys to specify the desired Wi-Fi Zone # (1–99).
 - TV Zone:** Enables you to set a TV Zone # so that the TV can be configured with Installer Menu and/or Setup Menu settings intended only for the assigned Zone. The Installer Menu and/or Setup Menu settings may be provided in a Clone/Configuration (.tlx) file. If the TV is being configured for FTG Mode via CPU, the TV Zone # setting also allows the TV to omit channels that have been restricted in the FTG Channel Map.
To change the TV Zone from its default value (0), navigate to the TV Zone field, and use the Left/Right arrow keys to specify the desired TV Zone # (1–8).
 - Label:** Allows you to select a North, South, East, or West text label for this TV. In the Label field, use the Left/Right arrow keys to select the applicable label.
 - Room Number:** Allows you to specify the number of the room—up to 16 characters—in which the TV is located. To enter a room number, navigate to the Room Number field and press **OK**. You can then use the number keys on the Installer Remote to direct enter a room number, or you can use the arrow keys to select the appropriate alphanumeric character(s) from the pop-up virtual keyboard at the bottom of the screen. When you are done, select **Enter** from the virtual keyboard, and then press **OK** on the Installer Remote.
Note: The TV name (default: TV’s serial number) will be changed to the room number specified here. See “Media Share Setup” on pages 76 to 77 for further information on the TV name.
- When you are ready to continue, use the arrow keys to select **SAVE**, and then press **OK** on the Installer Remote to return to the TV Configuration Options screen. Then, proceed as required; i.e., select **NEXT** to configure Pro:Centric settings or select **USB CONFIGURATION** to use a USB memory device to complete the configuration.

EZ-Manager Wizard (Cont.)

Configure Pro:Centric Settings

Once you select “NEXT” from the TV Configuration Options screen, the Searching for Pro:Centric Server screen is displayed.

Note: Select the “BACK” button, where available, to check previous settings, as necessary. Also note that if any of the configuration steps fails, you will see a “Diagnostics” screen with an indication of the failure. You will then have the opportunity to reinitiate the configuration process from the previous screen or exit the EZ-Manager Wizard.

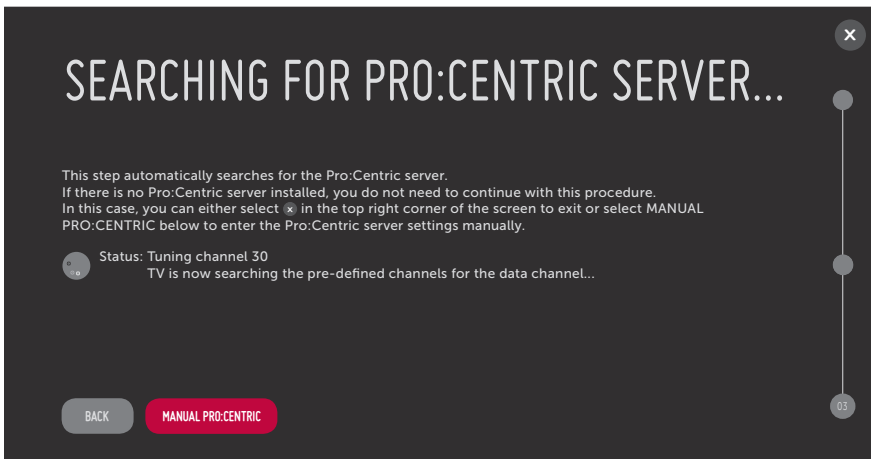

You have the following options:

- You can allow the EZ-Manager Wizard to proceed with a series of automated steps to configure the TV for Pro:Centric operation and then to look for the Pro:Centric application and maintenance (E-Z Installation) files to download. In this case, the wizard uses a search algorithm to determine the Data Channel and the Pro:Centric Application Mode to set in the TV.

Continue with the “Automated Pro:Centric Configuration” subsection below.

- If you already know the settings (e.g., Data Channel and Pro:Centric Application Mode) that need to be configured in order for the TV to connect to the Pro:Centric server and/or if the Pro:Centric server is not yet installed, you may expedite the setup process by entering this data manually.

Continue with the “Manual Pro:Centric Configuration” subsection on page 24.

Automated Pro:Centric Configuration

Note: If the server is not yet configured on the system, use the manual configuration option to configure the Pro:Centric operation. See also note below.

Note: If Pro:Centric data delivery will be over IP and there is a DNS server at the site, you can create a DNS entry “procentric.local” for the Pro:Centric server that will enable automated Pro:Centric IP configuration via the EZ-Manager. If there is no DNS entry for procentric.local, you must use the manual configuration option to configure the Pro:Centric IP operation.

Once the Pro:Centric data channel is found (a Pro:Centric Server Was Found screen will be displayed) and the Pro:Centric Application Mode is determined, the wizard will advance to the Processing the Pro:Centric Configuration screen, which shows the progress of the data downloads (see example on following page). Note that some steps may require a few minutes.

If the process is successful, no further user interaction is required, though, in some instances, where the option (for example, “NEXT”) is available, you may manually move forward to subsequent steps within the wizard to speed up the process.

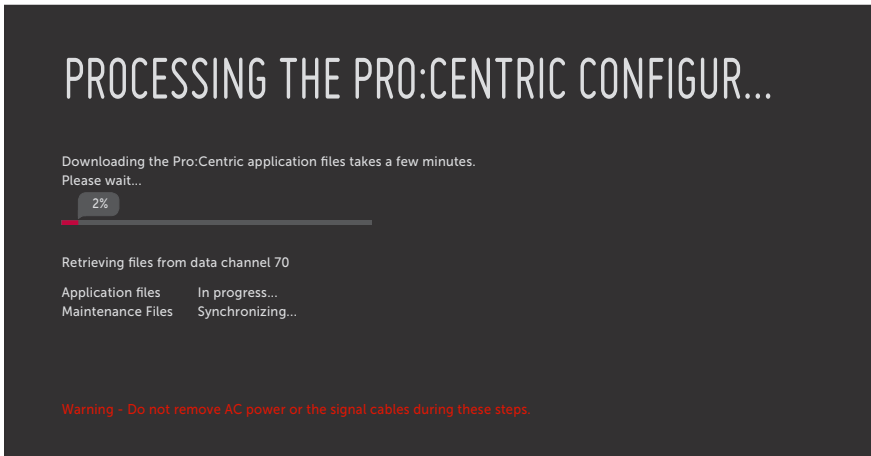

Note: If, after completing the search, the TV is unable to find the Pro:Centric data channel (while the Searching for Pro:Centric Server screen is on display), the wizard will stop and show a Diagnostics screen that enables you to manually return to the previous screen (to reinitiate the configuration) or exit the wizard.

When the Pro:Centric Configuration is complete, an EZ-Manager Configuration Complete screen is displayed (see example below), and after 10 seconds, the wizard exits, and the TV turns OFF.



Note: With the EZ-Manager Configuration Complete screen on display, you can also manually turn off or reboot the TV. If desired, select **TURN OFF** or **REBOOT**, respectively, and then press **OK** on the Installer Remote.

EZ-Manager Wizard (Cont.)

Manual Pro:Centric Configuration

1. With the Searching for Pro:Centric Server screen on display, use the Left/Right arrow keys on the Installer Remote to select **MANUAL PRO:CENTRIC** at the bottom of the screen, and then press **OK**.

In the Pro:Centric Manual Configuration screen (see examples below), you will be able to configure the appropriate Pro:Centric settings in the TV. Use the Up/Down arrow keys on the Installer Remote to navigate between fields.

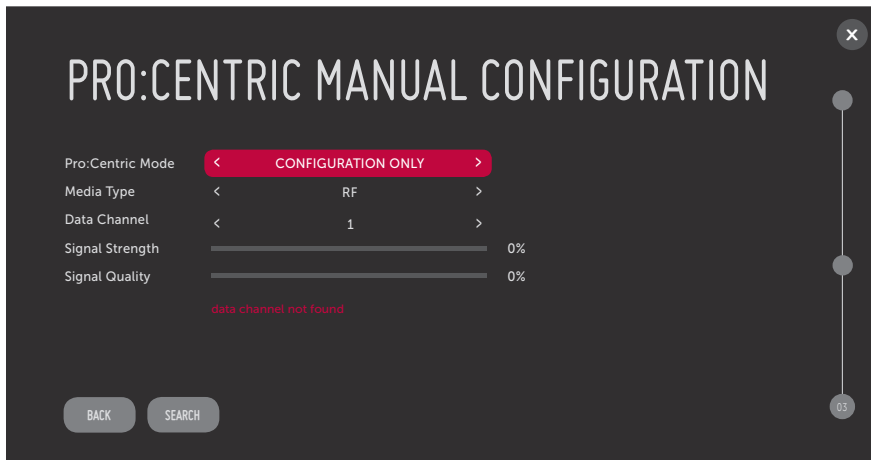

Pro:Centric Manual Configuration Screen with RF Media Fields

Note: By default, the Pro:Centric Manual Configuration screen initially shows RF configuration fields.

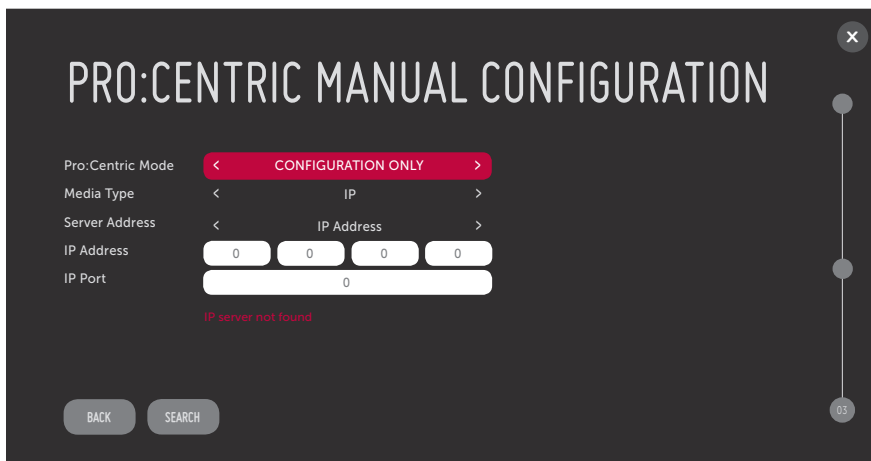

Pro:Centric Manual Configuration Screen with IP Media Fields

2. In the Pro:Centric Mode field, use the Left/Right arrow keys to select the appropriate Pro:Centric Application Mode—FLASH, GEM, HTML, or CONFIGURATION ONLY.

Note: For remote management only, select **CONFIGURATION ONLY**. The TV will search for TV E-Z Installation data downloads; however, Pro:Centric application data will not be downloaded, i.e., Installer Menu item 098 PRO:CENTRIC will be set to 0.

3. Refer to the appropriate subsection below, depending on the Pro:Centric server configuration, to complete the remaining fields.

(Continued on next page)

(Continued from previous page)

RF Configuration

- a) In the Media Type field, use the Left/Right arrow keys to select **RF**.
- b) In the Data Channel field, use the Left/Right arrow keys to select the RF channel number that will be used by the Pro:Centric server as its data channel. The Data Channel value can be set from 1 to 135.*

IP Configuration

- a) In the Media Type field, use the Left/Right arrow keys to select **IP**.
Note: When you select "IP" as the Media Type, the default RF Data Channel and Signal Strength/Quality fields are replaced with Server Address, IP Address, and IP Port fields.
- b) The Server Address field provides the option to specify the domain name of the Pro:Centric server instead of the server's IP address. Use the Left/Right arrow keys to select the desired option—IP Address or Domain Name—for defining the server.
- c) Depending on your selection in the previous step, either:
 - Enter the Pro:Centric server IP address in the IP Address field. The IP address must match the IPv4 multicast address that is set in the Pro:Centric server.
 - Enter the Pro:Centric server domain name in the Domain Name field. Note that in order for the domain name to be resolved to an IP address, there must be a DNS entry for the domain name.

For each data entry field: Use the arrow keys to select the field and press **OK**. Then, you can either use the number keys on the Installer Remote to direct enter data values, or you can use the arrow keys to select the appropriate number(s)/alphanumeric character(s) from the pop-up virtual keyboard displayed at the bottom of the screen. When you are done, select **Enter** from the virtual keyboard, and then press **OK** on the Installer Remote.

- d) Enter the Pro:Centric server port number in the IP Port field. The port number must match the port number that is set in the Pro:Centric server.
4. Once all fields are completed as required, you have two options:
- To save the data entered and exit the wizard, use the arrow keys to select the **✕** button at the top right of the screen, and then press **OK**. In the subsequent pop-up confirmation window, select **SAVE & EXIT**, and then press **OK** once more. The Pro:Centric application and/or E-Z Installation data will be downloaded to the TV at a later time. This option is useful, in particular, if the Pro:Centric server has not yet been configured.
 - To initiate a real-time download of Pro:Centric application and/or E-Z Installation data, use the arrow keys to select **SEARCH** and press **OK** to verify the configuration data provided in step 3. When the data is verified, the "SEARCH" button becomes a "NEXT" button. Select **NEXT** and press **OK** to continue (see also note below).

Note: With RF configuration, Pro:Centric server data must be present on the RF channel selected as the TV's Data Channel in order for you to select "NEXT" (you will see a "data channel found" message below the Signal Quality indicator). With IP configuration, Pro:Centric server data must be present via the wired LAN cable connection in order for you to select "NEXT" (you will see a "IP server found" message below the IP Port field).

(Continued on next page)

* PCS150R and later Pro:Centric servers do not support HRC or IRC cable channel frequencies.

EZ-Manager Wizard (Cont.)

(Continued from previous page)

If you opt to initiate a real-time download in the last step, the EZ-Manager Wizard will proceed with the Pro:Centric application and/or E-Z Installation data downloads (see Processing the Pro:Centric Configuration screen example on page 23). When the Pro:Centric configuration is complete, an EZ-Manager Configuration Complete screen (see example on page 23) is displayed, and after 10 seconds, the wizard exits, and the TV turns OFF.

Note: With the EZ-Manager Configuration Complete screen on display, you can also manually turn off or reboot the TV. If desired, select **TURN OFF** or **REBOOT**, respectively, and then press **OK** on the Installer Remote.

USB Configuration

TV Manager / USB download options enable you to download configuration or software files individually from a USB memory device to the TV. You can also use the Ez Download utility available from the menu to select multiple types of files to be downloaded at one time using one process.

Each of the USB download functions requires that you have the appropriate file(s) loaded on a USB memory device. If you wish to perform a software update or download splash screen/background image files, the software update/image file(s) must be stored in a folder named "LG_DTV" in the root directory of the USB memory device. Clone/Configuration (.tlx) files should simply be stored in the root directory of the USB device.

The procedure below assumes the desired file(s) is/are already loaded onto the USB device. For further information on the TV Manager / USB download options and file requirements, and/or for information on creating Clone/Configuration (.tlx) files, refer to the appropriate section(s) in this document.

Before You Begin

- If you intend to use the Zoning feature(s) on this TV, make sure to assign the appropriate TV Zone # and/or Wi-Fi Zone # in the EZ-Manager's Zones, Label, and Room Number screen BEFORE continuing with USB Configuration. See "TV Configuration Options" on page 20 for further information.
- Ensure the USB device to be used has been formatted with FAT format.
- When creating files to be downloaded, avoid using special characters (?, &, @, etc.) in filenames.
- Refer to "Ez Download Utility" on pages 38 to 41 for further information on the Ez Download utility.
- Refer to "Custom Master TV Setup" on pages 54 to 56 for information on creating a Clone (.tlx) file, and/or refer to "Creating an FTG Configuration File" on pages 64 to 65 for information on creating an FTG Configuration (.tlx) file for FTG Mode via CPU configuration.
- See Reference section, "Downloading a Splash Screen Image using a USB Memory Device," for splash screen image guidelines.
- See Reference section, "Downloading Background Images using a USB Memory Device," for background image guidelines.
- See Reference section, "Updating TV/PTC Software using a USB Memory Device," for further information on software updates.

USB Configuration via EZ-Manager Wizard

With either the TV Configuration Options or the Zones, Label, and Room Number screen on display, proceed as follows to configure the TV using the USB memory device.

1. Insert the USB memory device with the appropriate file(s) into either of the TV's USB ports.
2. Use the arrow keys on the Installer Remote to select **USB CONFIGURATION**, and then press **OK**.

You will be redirected to the TV Manager / USB download options.

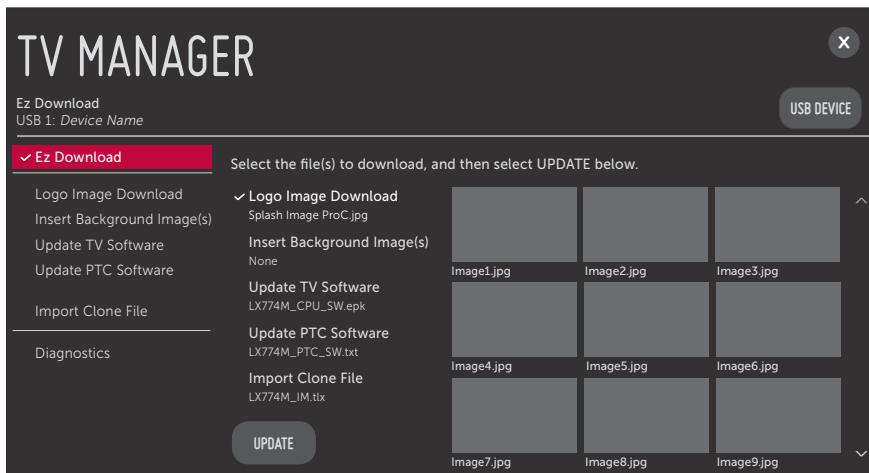

Note: You can select the **X** button at the top right corner of the screen and press **OK** on the Installer Remote at any time to return to the EZ-Manager Wizard.

Note: Ez Download is always selected by default when you initially access the TV Manager. Also note that Diagnostics is for service use only.

3. If more than one USB memory device is currently connected to the TV, be sure to select the USB device that contains the file(s) you wish to use. If necessary, use the arrow keys on the Installer Remote to select/highlight the **USB DEVICE** button at the top right of the screen and press **OK**. Then, use the Up/Down arrow keys to select the appropriate USB device from the pop-up list of USB devices displayed at the top of the screen.
4. Select the appropriate option from the TV Manager, and initiate the desired download(s).
Update progress will be displayed on the screen. Do NOT remove the USB device while updates are in progress. When the update process is complete, the TV will reboot. Upon restart, depending on the type of update(s) completed, either the EZ-Manager TV Configuration Options screen will be redisplayed (software and/or image updates only) or the TV will tune according to the Start Channel setting in the Installer Menu (TV configured with Clone/Configuration file).
Note: If the TV Configuration Options screen is redisplayed (software and/or image updates only), you can either proceed with configuration via the EZ-Manager Wizard or exit the EZ-Manager Wizard, as required.
5. Remove the USB memory device, and verify that the appropriate configuration/update(s) is/are resident on the TV.

Express Script

Initiate the Express Script

Note: The Express Script configures the TV for FTG Mode via CPU operation with Hospital Mode features. This means that while the TV is functioning in FTG Mode, Hospital Mode is enabled (i.e., Installer Menu item 027 HOSPITAL MODE is not set to 0). In addition, you can create custom channel lineups for Channel Banks 1 to 4.

Note: While the Express Script enables you to set up TVs individually in lieu of cloning, you can also use the resulting Express Script TV Setup for cloning purposes, if desired. However, note that TV setup menu customization via the Express Script is limited to Channels Menu options.

After you select the “Express Script” option from the First Use Wizard Welcome screen, an Express Script Welcome screen provides a brief introduction to the Express Script.

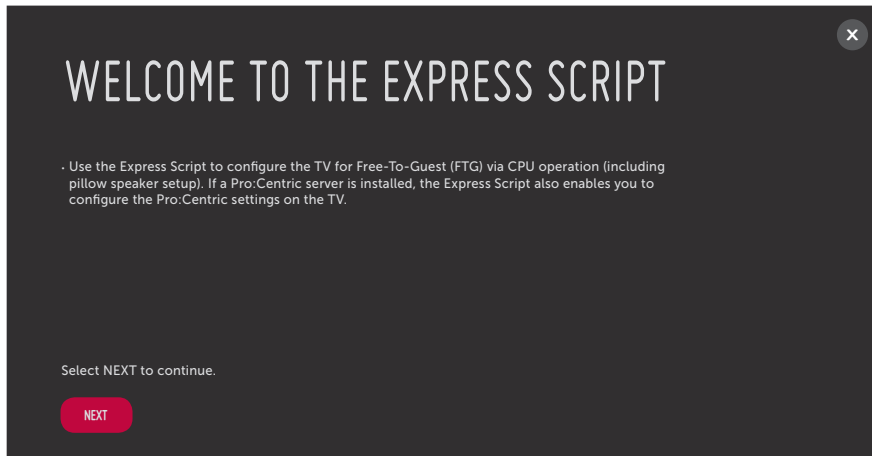

From the Express Script Welcome screen, you have the following options:

- To proceed with the Express Script, use the arrow keys on the Installer Remote to select **NEXT**. Then, press **OK** on the Installer Remote.

Note: Select this option even if you only intend to configure the Pro:Centric settings on this TV. After you configure the Pro:Centric settings, you will have the option to exit without completing the remainder of the wizard, if desired.

- To exit the Express Script without completing any configuration, use the arrow keys on the Installer Remote to select/highlight the **X** button, and then press **OK**. In the confirmation pop-up window, select **EXIT**, and then press **OK** once more on the Installer Remote.

Configure Pro:Centric Settings

The next screen enables you to set up the Pro:Centric feature of the TV (see screen examples below). By default, the Data Channel is configured for Auto Search, which enables the TV's Data Channel Auto Search feature to set the Data Channel value. See item 119 DATA CHANNEL description on page 52 for further information on the Data Channel Auto Search feature. The Pro:Centric Application Mode default setting is “Configuration Only,” which enables remote management only. That is, the TV will search for TV E-Z Installation data downloads; however, Pro:Centric application data will not be downloaded, i.e., Installer Menu item 098 PRO:CENTRIC will be set to 0.

(Continued on next page)

(Continued from previous page)

If you wish to proceed with the wizard without changing the default values for the Pro:Centric settings, you can simply select **NEXT** and press **OK** on the Installer Remote. Or, if you wish to exit the wizard while retaining the default values for Pro:Centric settings, use the arrow keys on the Installer Remote to select **DONE**, and then press **OK**.

If you already know the Pro:Centric settings that need to be configured in order for the TV to connect to the Pro:Centric server and/or if the Pro:Centric server is not yet installed, use the procedure on the following page to expedite the setup process. Use the Up/Down arrow keys on the Installer Remote to navigate between the fields.

Note: If you wish to disable the Pro:Centric feature of the TV, select the Data Channel field, and then use the Left/Right arrow keys on the Installer Remote to select **DISABLED**. From here, you may opt to proceed with the wizard (select **NEXT**) or save this setting and exit the wizard (select **DONE**). See also step 3 below.

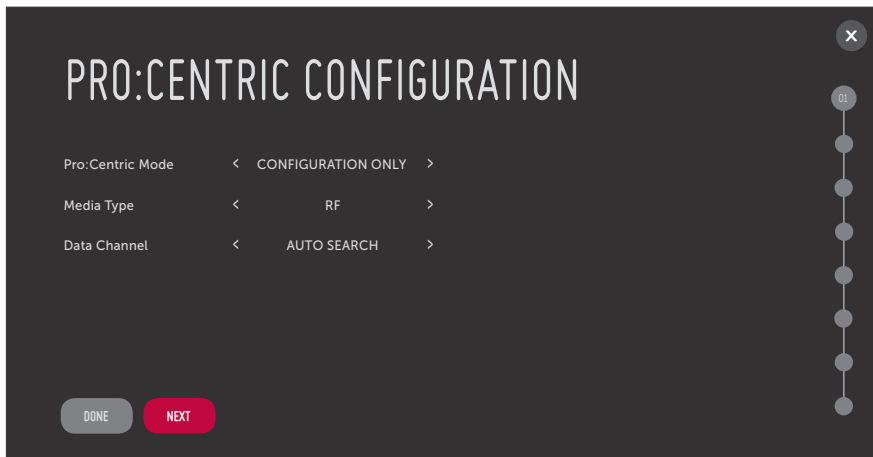

Pro:Centric Configuration Screen with RF Media Fields

Note: By default, the Pro:Centric Configuration screen initially shows RF configuration fields.

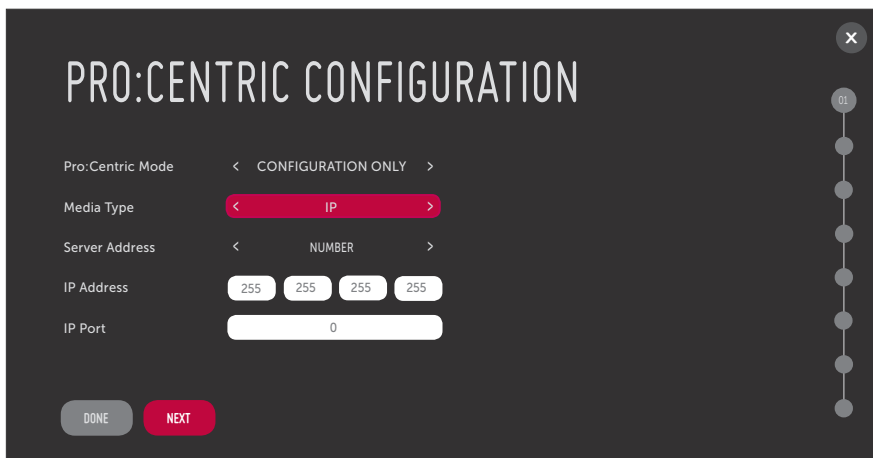

Pro:Centric Configuration Screen with IP Media Fields

(Continued on next page)

Express Script (Cont.)

(Continued from previous page)

1. In the Pro:Centric Mode field, use the Left/Right arrow keys on the Installer Remote to select the appropriate Pro:Centric Application Mode—FLASH, GEM, HTML, or CONFIGURATION ONLY.

Note: For remote management only, select **CONFIGURATION ONLY**. The TV will search for TV E-Z Installation data downloads; however, Pro:Centric application data will not be downloaded, i.e., Installer Menu item 098 PRO:CENTRIC will be set to 0.

2. Refer to the appropriate subsection below, depending on the Pro:Centric server configuration, to complete the remaining fields.

RF Configuration

- a) In the Media Type field, use the Left/Right arrow keys on the Installer Remote to select **RF**.
- b) In the Data Channel field, use the Left/Right arrow keys to select the RF channel number that will be used by the Pro:Centric server as its data channel. The Data Channel value can be set from 1 to 135.*

IP Configuration

- a) In the Media Type field, use the Left/Right arrow keys on the Installer Remote to select **IP**.
Note: When you select “IP” as the Media Type, the default RF Data Channel field is replaced with Server Address, IP Address, and IP Port fields.
- b) The Server Address field provides the option to specify the domain name of the Pro:Centric server instead of the server’s IP address. Use the Left/Right arrow keys to select the desired option—NUMBER or DOMAIN—for defining the server.
- c) Depending on your selection in the previous step, either:
 - Enter the Pro:Centric server IP address in the IP Address field. The IP address must match the IPv4 multicast address that is set in the Pro:Centric server.
 - Enter the Pro:Centric server domain name in the Domain Name field. Note that in order for the domain name to be resolved to an IP address, there must be a DNS entry for the domain name.

For each data entry field: Use the arrow keys to select the field and press **OK**. Then, you can either use the number keys on the Installer Remote to direct enter data values, or you can use the arrow keys to select the appropriate number(s)/alphanumeric character(s) from the pop-up virtual keyboard displayed at the bottom of the screen. When you are done, select **Enter** from the virtual keyboard, and then press **OK** on the Installer Remote.

- d) Enter the Pro:Centric server port number in the IP Port field. The port number must match the port number that is set in the Pro:Centric server.

(Continued on next page)

* PCS150R and later Pro:Centric servers do not support HRC or IRC cable channel frequencies.

(Continued from previous page)

3. Once all fields are completed as required, you have two options:
 - To proceed with TV configuration via the Express Script, select **NEXT** and press **OK** on the Installer Remote. Continue to “Complete the TV Configuration” on the following page.
 - To save the data entered and exit the Express Script, use the arrow keys to select **DONE** and then press **OK** on the Installer Remote. Remember, however, that if you do not complete the Express Script, pillow speaker functionality will not be enabled unless you set Installer Menu item 027 HOSPITAL MODE appropriately. See the “Installer Menu” section of this document for further information.

Complete the TV Configuration

The following procedure describes the remaining steps in the Express Script. You can select the “BACK” button, where available, to check previous settings, as necessary. Typically, if you do not modify the default settings, the “NEXT” button is automatically selected when you proceed forward within the Express Script. Where appropriate, you can simply press **OK** on the Installer Remote to proceed to the next step if the default value(s) for the TV parameter(s) in question are applicable for your installation.

 **Note: If you choose to exit the Express Script from this point on, any settings made will not be retained.**

1. In the Select the Tuning Band screen, use the Up/Down arrow keys on the Installer Remote to highlight/select the appropriate tuning band option: Cable Standard (default), Cable HRC, Cable IRC, or Air. Then, press **OK**. When you have made your selection, use the arrow keys to select **NEXT**, and then press **OK**.

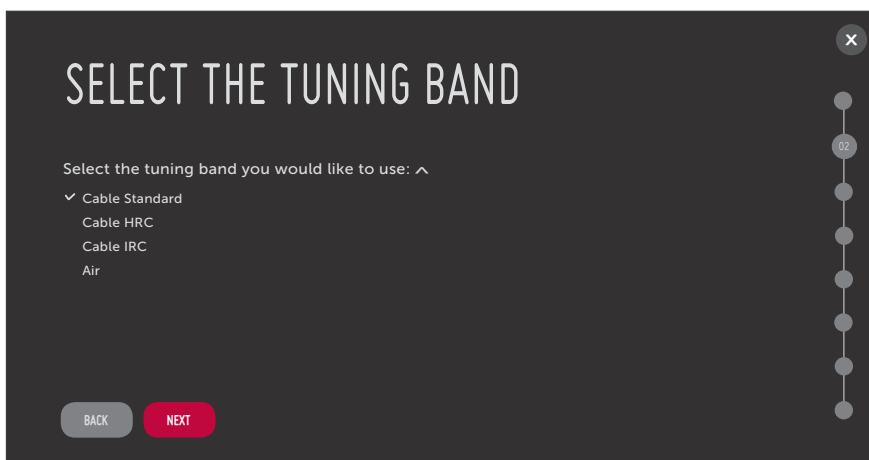

2. By default, all Aux inputs are enabled, as shown initially in the Enable/Disable Aux Inputs screen. To disable an Aux input, use the arrow keys on the Installer Remote to select the desired input, and then press **OK** to toggle the status of the Aux input.

(Continued on next page)

Express Script (Cont.)

(Continued from previous page)

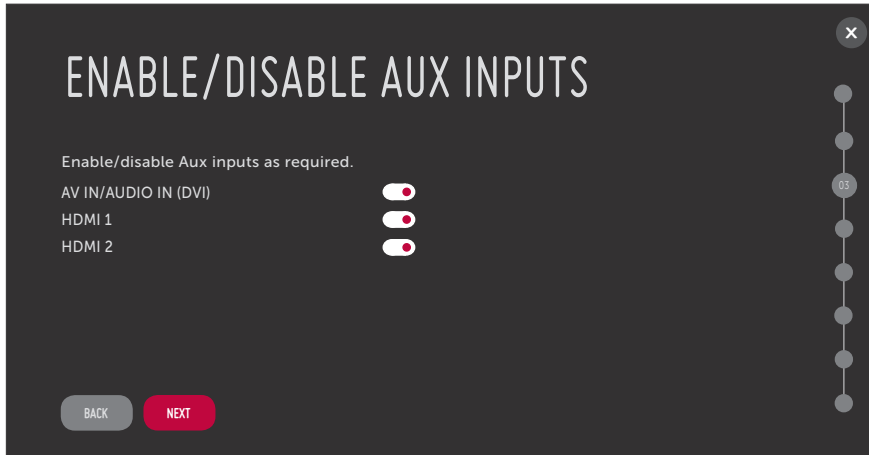

Enabled Aux inputs are included in the channel lineup. If an Aux input will not be used, it is typically advisable to disable it, though you may also simply delete it from the channel lineup in step 5, if you want to leave it enabled in the Installer Menu. When you are ready to continue, use the arrow keys to select **NEXT**, and then press **OK**.

Note: After the TV setup is complete (see step 7), the only way to add or remove Aux inputs to/from the FTG Channel Map, is to edit the FTG Channel Map using the FTG Channel Map Editor in the FTG File Manager. Refer to the *Free-To-Guest (FTG) File Manager User Guide* for further information.

Note: Disabled Aux inputs are not included in the channel lineup. However, if you wish to enable a disabled Aux input in the future, you may do so by changing the applicable Installer Menu settings (see Installer Menu information in this document). See also note above.

3. In the Speaker Selection screen, you will be able to select the speaker configuration for the TV. This selection sets Installer Menu item 027 HOSPITAL MODE, which also means that when the Express Script is complete, the TV will be operating in FTG Mode via CPU with Hospital Mode features enabled. See item 027 description on page 48 for further information.

Use the arrow keys on the Installer Remote to select the appropriate speaker configuration:

- Highlight/select the desired speaker: Pillow Only (default), TV Only, or Pillow & TV. Then, press **OK**.
- If applicable, select the pillow speaker code/voltage and press **OK**.

Note: If using a Pro:Centric pillow speaker (LG IR codes) or a pillow speaker with Zenith IR codes, make sure the “Zenith” pillow speaker code (default) is selected.

When you have made your selection(s), use the arrow keys to select **NEXT**, and then press **OK**.

(Continued on next page)

(Continued from previous page)

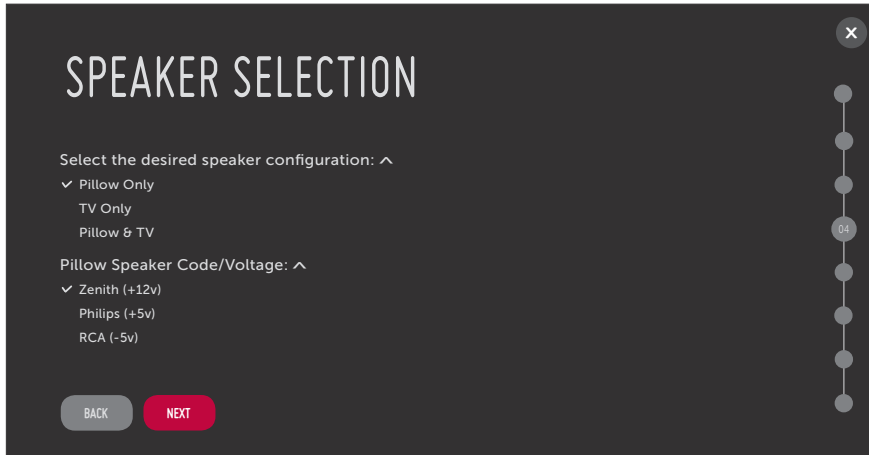

4. In the Channel Tuning screen, you have the option to initiate an automated channel scan that will search for all available digital and analog channels. Select **RUN AUTO TUNING** and press **OK** on the Installer Remote to start the channel scan.



Note: You **MUST** select **RUN AUTO TUNING** and press **OK** in order to run the channel scan. If you move on to the next step without running Auto Tuning, there will be no digital or analog channels in the channel lineup. In this case, upon completion of the Express Script, the only channels in the resulting FTG Channel Map will be any enabled Aux inputs.

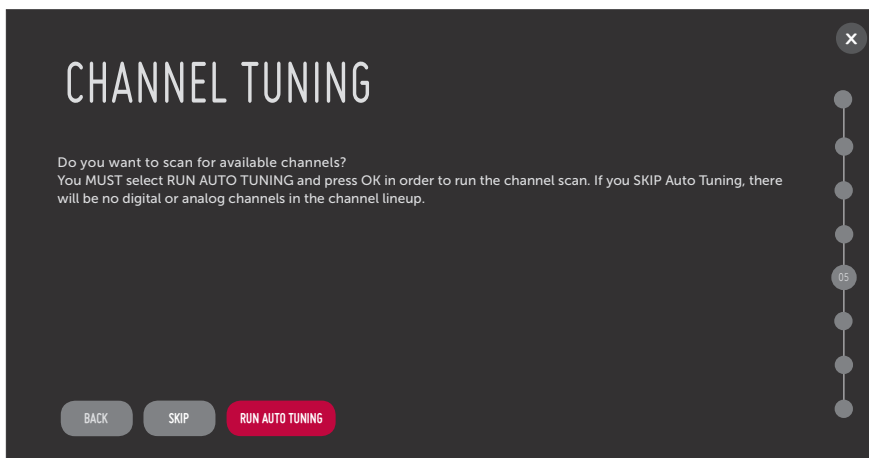

Auto Tuning progress will be shown in a new Channel Tuning screen. The scan typically takes a few minutes. When the channel scan is complete, the Express Script will automatically advance to the Edit the Channel Lineup screen. Continue with step 5.

Note: If you do not want to run Auto Tuning, use the arrow keys on the Installer Remote to select **SKIP** and press **OK**.

(Continued on next page)

Express Script (Cont.)

(Continued from previous page)

5. In the Edit the Channel Lineup screen, you can customize the channel lineup, add channel labels and icons, etc. before the channel lineup is used to create an FTG Channel Map in step 7. You can also set up channel banks in this screen.

Note: The total number of channels found (“Searched”) during Auto Tuning is indicated at the top left of the display.

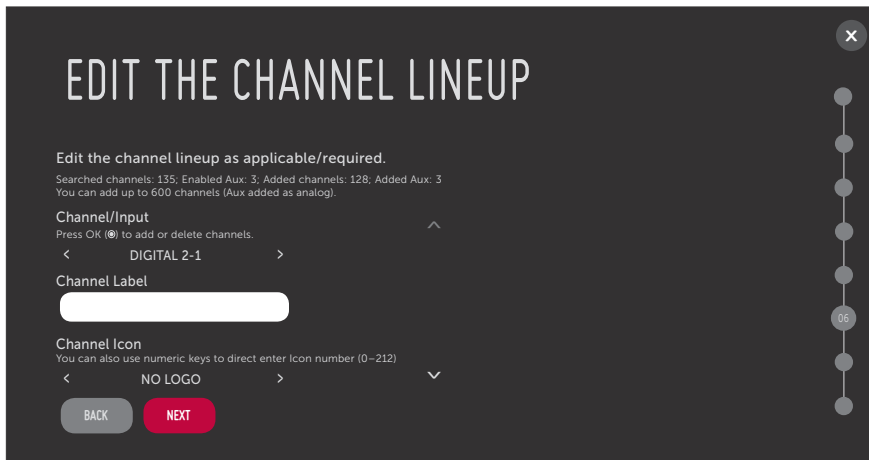

Note: If, for any reason, you elect to re-run Auto Tuning after customizing channels in the Edit the Channel Lineup screen, your current custom channel settings will be lost, and you will need to replicate the desired customization.

Use the arrow keys to navigate between the fields in this screen:

- Channel/Input: Edit the channel lineup, as necessary. Use the Left/Right arrow keys on the Installer Remote to select channels (including Aux inputs), and press **OK** to delete (or re-add) channels per the installation site requirements.

Note: When a channel is active in the channel lineup (i.e., added), all additional fields in this screen are selectable/available. If a channel is deleted, all other fields in this screen become inaccessible (grayed out).

- Channel Label: Press **OK** to display the pop-up virtual alphanumeric keyboard, and add a custom text label for each channel/Aux input (up to 17 characters), as desired.
- Channel Icon: This field enables you to select the appropriate trademark/icon for each channel's Channel-Time on-screen display. If known, you can direct enter the icon number using the number keys on the Installer Remote. Otherwise, use the arrow keys on the Installer Remote to select/highlight either the left (<) or right (>) arrow in the Channel Icon field, and press **OK** until the desired logo is shown. Icons are available for familiar channels, such as ABC, CBS, NBC, etc. Identifiable icons should enable the end user to readily know what common networks are available.

(Continued on next page)

(Continued from previous page)

- Channel Banks: All channels found during Auto Tuning automatically are added to and active in all four channel banks. Use the arrow keys to define channel banks, as desired. See “Channel Banks Overview” on following page for additional information.

Note: Channel Banks fields are below the Channel Icon field. Use the Up/Down arrow keys on the Installer Remote to scroll through all fields. See also example in “Channel Banks Overview” section.

When you are finished, use the arrow keys to select **NEXT**, and then press **OK**.

6. In the Channel Tuning/Channel Banner screen, use the Up/Down arrow keys on the Installer Remote to highlight/select the appropriate channel tuning/channel banner display format option—either Logical (default) or Physical—for the installation site. When you have made your selection, use the arrow keys to select **NEXT**, and then press **OK**.

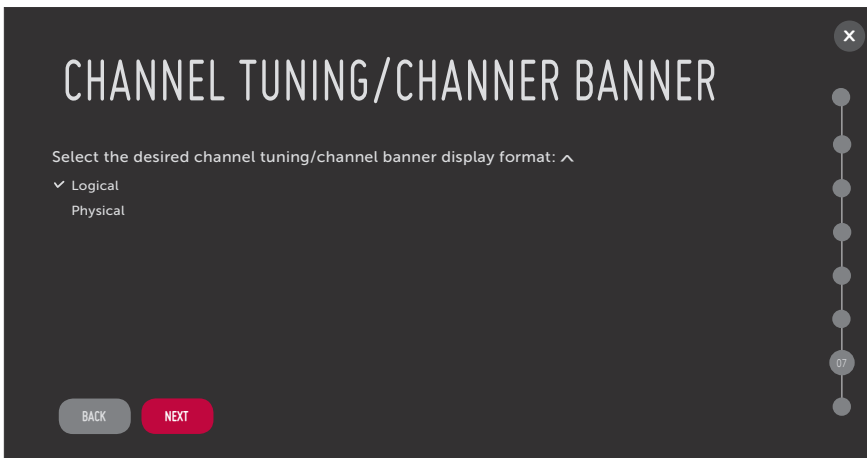

7. As the final step of the Express Script, the TV saves your settings and uses the channel/Aux input lineup to create an FTG Channel Map before configuring the TV for FTG Mode via CPU (see also notes below). When you are ready to proceed, select **FINISH**, and then press **OK**.

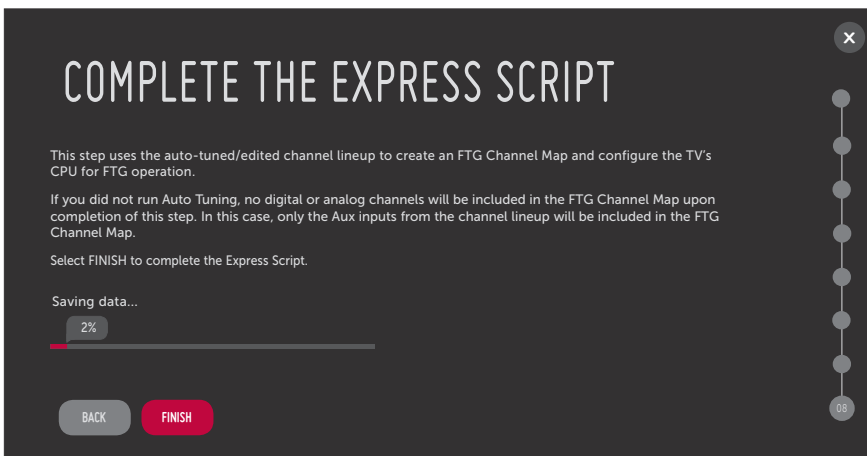

(Continued on next page)

Express Script (Cont.)

(Continued from previous page)

Configuration progress will be shown at the bottom of the screen. When this step is complete, the Express Script exits, and the TV tunes to the first channel in the FTG Channel Map. Also when the Express Script is complete, the TV is set for Channel Bank 1. If required, you can set up/modify channel banks at a later time using LG's FTG File Manager. See "Channel Banks Overview" below for further information.

Note: If desired, the TV Setup created from the Express Script may also be saved to a USB memory device and used for cloning purposes (see "Cloning Procedures" on pages 50 to 56 for further information).

Note: Aux inputs (if enabled) will appear between the highest analog and lowest digital channel number in the FTG Channel Map when Channel Up/Down is used on the Installer Remote.

Note: If you did not run Auto Tuning and all Aux inputs are disabled, an FTG Channel Map will NOT be created and the TV will not be configured for FTG Mode via CPU.

Channel Banks Overview

Channel Banks enable institution administrators to create tiered channel programming on patient in-room TVs. Each channel bank may offer a custom channel lineup for a pre-determined fee. The Express Script enables you to configure four channel banks (1, 2, 3, and 4) for the channel lineup (see step 5 of procedure above and also example below). The top tier generally contains the most programming (premium, etc.), 2nd tier = lesser programming, 3rd tier = basic programming, etc. It is also possible to create an Inactive TV display with Channel Bank 4, so that an "Inactive TV Call Attendant" message appears when the TV is turned ON. In this case, an administrator can then select another channel bank on the patient's in-room TV depending on the programming tier requested by the patient.

All channels found during Auto Tuning automatically are added to and active in all four channel banks. See "Channel Attributes and Channel Bank Allocation" below for further information. If you would like to modify channel banks after completing the Express Script (or after enabling Hospital Mode by setting Installer Menu item 027 accordingly), you can save (export) the FTG Channel Map to a USB memory device and then use the FTG Channel Map Editor in the FTG File Manager to make the required changes (see also "Updating Channel Attributes and/or Channel Bank Allocation" below).

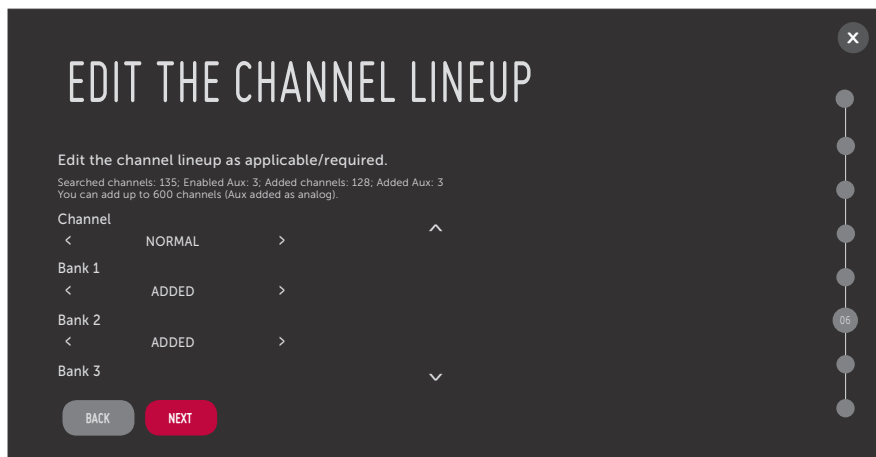

Channel Attributes and Channel Bank Allocation

Three attributes are available for each channel: Encrypted, OSD, and Blank Video. When the TV creates an FTG Channel Map upon completion of the Express Script, the OSD attribute (displays the channel number, label, and icon) is automatically assigned to all channels, and the Encrypted attribute is assigned to each Pro:Idiom encrypted channel detected during the channel scan. The Blank Video attribute is not assigned automatically to any channels; however, in the “Edit the Channel Lineup” screen of the Express Script, you have the option to assign the Blank Video (i.e., “BLANK”) attribute to channels, as required. When you assign the BLANK attribute to a channel (as opposed to the default “NORMAL”), this means that the channel audio will be audible; however, its video will be black (no picture). The NORMAL or BLANK attribute applies to the channel regardless of channel bank allocation.

Once you have set a channel’s NORMAL/BLANK attribute, determine the channel bank allocation for each of the four available channel banks: ADDED or DELETED. When DELETED, the channel will not appear in the channel lineup of the currently selected channel bank.

Selecting a Channel Bank

To select a channel bank, press **CH. BANK** on the Installer Remote. The first time you press the CH. BANK key, the TV display will show the currently active channel bank (default = Channel Bank 1). Each successive CH. BANK key press selects channel banks numerically, i.e., from Channel Bank 1 to Channel Bank 4. Press **CH. BANK** repeatedly until the desired channel bank is selected.

Updating Channel Attributes and/or Channel Bank Allocation

If you would like to modify channel attributes and/or channel bank allocation and/or update the FTG Channel Map in general, you can save (export) the FTG Channel Map to a USB memory device (see “Exporting a Clone File” on pages 57 to 59) and then use the FTG Channel Map Editor in the FTG File Manager to make the required changes. In the FTG Channel Map Editor, Zones 1 to 4 are used to create custom channel lineups for Channel Banks 1 to 4. A checked Zone Restriction (1 to 4) checkbox means that the selected channel is “deleted” from the same numbered channel bank. Refer to the “FTG Channel Map Editor” overview on page 68 and also the *Free-To-Guest (FTG) File Manager User Guide* for further information. FTG File Manager software is available at: www.lg.com/us/business/display-solutions/ftg.

Inactive TV Setup

To create an inactive TV display on Channel Bank 4, you need to modify the channel bank allocation for each channel in Channel Bank 4 to DELETED. You can do this in the Express Script, or you can use the FTG Channel Map Editor in the FTG File Manager as indicated above.

When the TV is turned ON by the patient, an “Inactive TV Call Attendant” message will appear on the screen, and after a few moments the TV will turn itself OFF. This will prompt the patient to arrange for an available programming package on Channel Bank 1, 2, or 3. Using the Installer Remote, the administrator can select Channel Bank 1, 2, or 3 depending on the entertainment programming tier selected by the patient. When the patient leaves the hospital, the administrator can then select Channel Bank 4 to reinstate the “Inactive TV” message.

Ez Download Utility

The Ez Download utility, available from the TV Manager, enables you to select multiple files at one time from the files loaded on a USB memory device. You may use this utility to download any one or all of the following to a TV:

- One Clone or FTG Configuration (.tlx) file
- One TV CPU software update
- One PTC software update
- One splash screen image
- Up to 12 background images

Before You Begin

- Ensure the USB device has been formatted with FAT format.
- Software update and splash screen image files must be stored in a folder named “LG_DTV” in the root directory of the USB memory device. Clone/Configuration (.tlx) files should simply be stored in the root directory of the USB device.
- If you have initiated the EZ-Manager Wizard, you can use the wizard’s “USB Configuration” option to access the Ez Download utility, if desired (see “TV Configuration Options” and/or “USB Configuration” on pages 20 and 26, respectively, as necessary).
- If the TV is currently in Pass-through Mode and you intend to use the Zoning feature(s) on this TV for location-specific configuration purposes, make sure to assign the appropriate TV Zone # and/or Wi-Fi Zone # in the TV when directed to do so in the procedure below.
- When creating files to be downloaded, avoid using special characters (?, &, @, etc.) in filenames.
- Refer to “Custom Master TV Setup” on pages 54 to 56 for information on creating a Clone (.tlx) file, and/or refer to “Creating an FTG Configuration File” on pages 64 to 65 for information on creating an FTG Configuration (.tlx) file for FTG Mode via CPU configuration.
- See Reference section, “Downloading a Splash Screen Image using a USB Memory Device,” for splash screen image guidelines.
- See Reference section, “Downloading Background Images using a USB Memory Device,” for background image guidelines.
- See Reference section, “Updating TV/PTC Software using a USB Memory Device,” for further information on software updates.



Caution: Do not unplug the TV power cord or remove the USB memory device during a data download, as doing so may cause the TV to malfunction or harm the USB device, respectively.

Accessing and Using the Ez Download Utility

1. If it is not ON already, turn ON the TV.
2. The next step depends on whether the LG First Use Wizard appears on the screen when you turn ON the TV:

(Continued on next page)

(Continued from previous page)

- If the wizard is displayed, you can access the Ez Download utility via the EZ-Manager Wizard, as indicated above (see “Before You Begin”). However, to continue with this procedure and access the Ez Download utility from the TV menus, exit the First Use Wizard. Then, continue with step 3.
 - If the wizard is not displayed, go directly to step 3.
3. If the TV is currently in Pass-through Mode, you would like to transfer (import) a “.tlx” file to the TV via the Ez Download utility, and you intend to use one or both of the TV’s Zoning feature(s), assign the appropriate TV Zone # and/or Wi-Fi Zone # in the TV at this time. See Reference section, “Using the TV’s Zoning Features,” for further information.



Note: In order for the proper location-specific TV Zone and/or Wi-Fi Zone profile data to be applied, the Zone designation(s) must be assigned in the Target TV(s) BEFORE you continue with the Ez Download utility.

4. Insert the USB memory device with the appropriate file(s) into either of the TV’s USB ports.
5. To access the TV Manager from the TV menus:
- Press **MENU** on the Installer Remote to display the TV setup menus (TV is in Pass-through Mode) or the Function Menu (TV is not in Pass-through Mode).
 - If the Quick Settings Menu is displayed at the right of the screen (i.e., the TV is in Pass-through Mode), select the **All Settings**  menu icon and press **OK** to access the advanced TV setup menus.
 - Use the arrow navigation keys to select/highlight either the **General** menu icon from the TV setup menus or the **Safety** menu icon from the Function Menu. Then, press the number “7” key a total of seven times.

Note: Ez Download is always selected by default when you initially access the TV Manager. Also note that Diagnostics is for service use only.

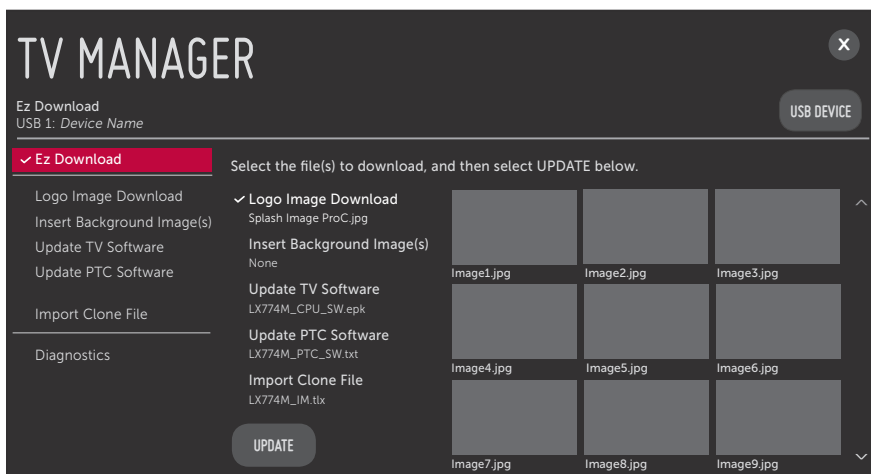

(Continued on next page)

Ez Download Utility (Cont.)

(Continued from previous page)

- If more than one USB memory device is currently connected to the TV, be sure to select the USB device that contains the file(s) you wish to use. If necessary, use the arrow keys on the Installer Remote to select/highlight the **USB DEVICE** button at the top right of the screen and press **OK**. Then, use the Up/Down arrow keys to select the appropriate USB device from the pop-up list of USB devices displayed at the top of the screen.



- If it is not currently selected, use the arrow keys to select **Ez Download**, and then press **OK**.

As illustrated in the example on the previous page, when Ez Download is selected, a list of files/file types is displayed on the screen. Remember that Logo (i.e., Splash Screen) Image, Background Image, TV Software (CPU), and PTC Software files must be stored in the LG_DTV folder and Clone/Configuration (.tlx) files must be stored in the root directory on the USB device.

Note: Select the **X** button in the top right corner of the screen, as necessary, to exit the TV Manager. If you accessed the TV Manager via the EZ-Manager Wizard, you will be returned to the last screen on display before you selected the "USB Configuration" option. If you accessed the TV Manager via the TV menus, you will be returned to program viewing.

- To select a file:
 - Use the arrow keys on the Installer Remote to select/highlight the appropriate file type field, and then press **OK**. A list of available files will be displayed to the right of the file type fields.
 - Then, use the arrow keys to select the desired file.

Note: With the exception of background image files, the utility will only allow you to select one of each file type for downloading. For example, if there are two files in the Ez Download "Import Clone File" list, you can only select one or the other of those two files.

Note: The initial default value for each file type is "None." After the Ez Download utility is run, a file is automatically created and stored on the USB device that was used. The file, which will have a ".dzm" file extension, maintains a history of the file(s) previously used with the Ez Download utility. The next time(s) you use this USB device with the Ez Download utility, the file(s) selected for the last download will be pre-selected for the current download, thus facilitating the process of configuring additional TVs of this model using the same USB device.

Note: The current TV software (CPU) or PTC software version is always displayed above the listing of available TV software and PTC software files, respectively. Ensure the software version of the selected file is the correct version before applying the update to this TV.

(Continued on next page)

(Continued from previous page)

9. If a Clone/Configuration (.tlx) file that includes an FTG Channel Map is selected, a Channel Tuning / Channel Banner Display field will be displayed at the right of the screen. If the FTG Channel Map comprises RF channels and Aux inputs *only* (the latter designated by 130-0 through 137-0), you can choose the format for the channel tuning/banner display. Use the arrow keys on the Installer Remote to select **Logical** tuning or **Physical** tuning. A checkmark will appear at the left of the selected option. Logical tuning is selected by default.

Note: If an FTG Channel Map includes IP channels, only logical tuning is available. Also, if the selected “.tlx” file does not include an FTG Channel Map, the message, “No Channel Map in Clone file,” will be displayed at the right of the screen.

10. When you are ready to continue, use the arrow keys on the Installer Remote to select **UPDATE**, and then press **OK**.

Update progress will be displayed on the new screen. Do NOT remove the USB device while updates are in progress. When the Ez Download process is complete, an overview of the results will briefly be displayed and then, the TV will reboot.

11. Remove the USB memory device, and verify that the appropriate configuration/update(s) is/are resident on the TV.

Note: If you updated the TV configuration with a Clone/Configuration file, upon restart, the TV tunes according to the Start Channel setting in the Installer Menu. If a Start Channel is specified, the TV will tune to that channel, though in the case of FTG Mode via CPU configuration, a channel banner will only be displayed if the Start Channel is included in the FTG Channel Map (depending on your selection in step 9, the channel banner will display either the Start Channel's logical channel number or physical RF channel number). Otherwise, the TV will either return to the last channel tuned (TV in Pass-through Mode) or tune to the first channel in the FTG Channel Map (TV in FTG Mode via CPU). In the latter case, remember that the channels in the FTG Channel Map are always arranged in logical order, regardless of your selection in step 9.

Installer Menu

Use the Installer Menu to set up, change, or view operational settings. This section describes how to access, use, and exit the Installer Menu from the TV itself. However, you should also refer to the Installer Menu descriptions in this document if you are configuring the TV CPU using an FTG Configuration (.tlx) file created using LG's FTG File Manager software or configuring the EBL locally (.rml) or remotely (via FMA-LG102 / .fma) using the FTG Device Configuration Application software.

Refer to the table on pages 44 to 46 for brief descriptions of Installer Menu items. More detailed descriptions follow the table listing.

Accessing the Installer Menu

1. Turn ON the TV.

If the LG First Use Wizard appears on the screen when you turn ON the TV, exit the wizard.

2. Using an Installer Remote, press **MENU** repeatedly until the on-screen display of the TV setup menus (if the TV is in Pass-through Mode) or the Function Menu (if the TV is not in Pass-through Mode) no longer toggles, and then press the Installer Menu entry sequence (e.g., **9-8-7-6**) + **OK** to access the Installer Menu.

Note: The default Installer Menu entry sequence is "9876"; however, if Installer Menu item 000 INSTALLER SEQUENCE has been modified, the entry sequence may be one of three additional options. See Installer Menu detailed descriptions for further information.

The Installer Menu opens with item 000 INSTALLER SEQ 000.

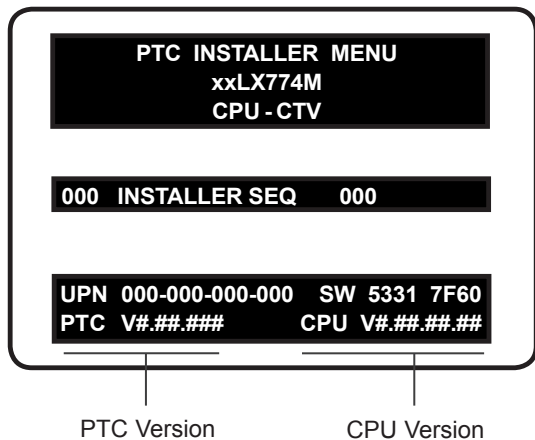

Typical Installer Menu

The Installer Menu header will vary depending on the TV you are setting up. In the Installer Menu footer, you can see the current software versions of the TV, as indicated.

Note: If the password (entry sequence) is not entered or registered correctly, you will see the message "ENTER PASSWORD 0000" at the top of the screen instead of the Installer Menu header. Once you re-enter the correct password (e.g., press 9-8-7-6 + OK), the Installer Menu will display.

Note: If the TV is not in Pass-through Mode, the Installer Menu is accessible as read-only. Also, the TV Zone # will be indicated in the Installer Menu header under the configuration mode indicator described below.

As part of the Installer Menu header (in all modes), two 3-character acronyms are displayed to indicate the TV's current configuration mode. The table below lists all possible mode identifiers for these TV models.

| Acronym | Description |
|---------|--|
| CPU-CTV | Pass-through Mode with Channel Lineup in CPU |
| CPU-FTG | FTG Mode via CPU |
| CPU-P:C | Application Tuning Mode via CPU |
| EBL-FTG | FTG Mode via EBL |
| EBL-LNT | SONIFI PPV Mode |
| MPI-EXT | External MPI Control |
| PTC-CTV | Pass-through Mode with Channel Map in PTC |

Navigating Within the Installer Menu

Use the Up/Down arrow keys on the Installer Remote to sequence through the available menu items, or access an item directly by keying in the item number and then pressing **MENU**. For example, to access the SLEEP TIMER option, which is item 015, press 0-1-5 + MENU.

Installer Menu items not relevant to these TV models are not present in the Installer Menu; therefore, some numbers are missing. For example, item 006 will not appear. In addition, items that are dependent on other Installer Menu item settings will not be initially accessible. For example, item 046 STRT AUX SRCE will not display in the Installer Menu unless item 004 STRT CHANNEL is set to 0. See Installer Menu detailed descriptions for further information.

Modifying Installer Menu Settings

Refer to the table starting on the next page for an overview of the available Installer Menu items, including their item numbers, functions, value ranges, and default values.

To change an Installer Menu item value, use the Left/Right arrow keys on the Installer Remote to select the appropriate value, or direct enter a valid value. To save the new setting, press **OK** once on the Installer Remote. If you have additional items to modify, use the Up/Down arrow keys to navigate to a new Installer Menu item or access an item directly as described in the previous section. Note that invalid values will not be saved.



Caution: In order for Installer Menu item changes to be saved, you must press **OK** as indicated above and then exit the Installer Menu as described below. Never remove power from the TV while in the Installer Menu. Also, remember that Installer Menu settings may affect options available from the TV setup menus or the Function Menu.

Exiting the Installer Menu and Activating Settings

After you have saved all desired Installer Menu item changes (i.e., press **OK** once on the Installer Remote to save changes), press **OK** again to exit the Installer Menu. Any changes you make will be stored in non-volatile memory.

Note: Each time you exit the Installer Menu in Pass-through Mode, all V-Chip (Parental Control) settings in the TV are reset to their default values; that is, the Lock System, if previously enabled from the Safety Menu, will now be disabled, and the individual Parental Control settings will be restored to default values.

Installer Menu (Cont.)

Installer Menu Items 000 through 046

| Item | Function | Value Range | Default Value | Brief Description of Function |
|------|---------------|---------------------|---------------|--|
| 000 | INSTALLER SEQ | 0–3 | 0 | Leave default set to 0. |
| 001 | POWER MANAGE | 0–7 | 0 | Selects the number of hours of inactivity allowed before the TV automatically turns itself OFF. Set to 0 to disable Power Management. |
| 002 | AC ON | 0–3 | 0 | Set to 1 to enable TV to turn ON when AC power is applied. Set to 2 or 3 to enable Instant ON when AC power is applied. (See detailed descriptions.) |
| 003 | BAND/AFC | 0–3 | 1 | Selects Tuning Band: 0=Broadcast, 1=CATV, 2=HRC, 3=IRC |
| 004 | STRT CHANNEL | 0–127, 253, 255 | 255 | Channel tuned when TV is turned ON. (Set to 255 to tune to channel tuned before TV turned OFF.) |
| 005 | CHAN LOCK | 0 / 1 | 0 | If set to 1, cannot tune from current channel. |
| 007 | STRT VOLUME | 0–63, 255 | 255 | Volume level when TV is turned ON. (Set to 255 to use volume level before TV turned OFF.) |
| 008 | MIN VOLUME | 0–63 | 0 | Sets minimum allowable volume setting. |
| 009 | MAX VOLUME | 0–63 | 63 | Sets maximum allowable volume setting. |
| 010 | MUTE DISABLE | 0 / 1 | 0 | Set to 1 to disable Mute Function. |
| 011 | KEY DEFEAT | 0 / 1 | 1 | If set to 1, joystick button menu navigation functions on display panel are not available. |
| 012 | IR BANKS EN. | 0 / 1 | 0 | Set to 1 to enable TV to respond to bank discrete IR codes. |
| 013 | SCAN MODE | 0 / 1 | 1 | Set to 1 to allow Channel Up/Down to turn ON TV. (See detailed descriptions.) |
| 014 | STRT CH IN SM | 0 / 1 | 0 | Set to 1 to use the Start Channel for the Channel Map pivot point in Scan Mode. |
| 015 | SLEEP TIMER | 0 / 1 | 1 | Set to 1 to enable Sleep Timer. |
| 016 | EN. TIMER | 0 / 1 | 1 | Set to 1 to enable On/Off Timers. |
| 017 | ALARM | 0 / 1 | 1 | Set to 1 to enable Alarm. |
| 020 | FEATURE LEVEL | 0, 1, 16–24, 64, 65 | 1 | Determines an additional IR code scheme to which the TV will respond. |
| 021 | V-CHIP | 0 / 1 | 1 | Set to 1 to enable V-Chip (Parental Control) functions. |
| 022 | MAX BLK HRS | 0–99 | 12 | Sets number of V-Chip blocking hours. |
| 023 | CAPTION LOCK | 0 / 1 | 0 | Set to 1 to retain caption setting set before TV turned OFF. |
| 025 | FUNCTION PRE. | 0 / 1 | 1 | Set to 1 to allow Channel Preview/Banks Setup Menu access via CH PREVIEW key on Installer Remote. |
| 027 | HOSPITAL MODE | 0–162, 254 | 254 | Set according to the speaker selection, the pillow speaker code/supply voltage, and the hospital IR code. See detailed instructions. |
| 028 | CH. OVERRIDE | 0 / 1 | 1 | If set to 0, users can only tune to channels that are included in the PTC Channel Map. (See detailed descriptions.) |
| 029 | OLD OCV | 0 / 1 | 0 | Set to 1 to remap the PTC's direct tune channels for Aux inputs from 13x to 9x. |
| 030 | ACK MASK | 0 / 1 | 0 | If set to 1, enables ACK feature of MPI. |
| 031 | POLL RATE | 20–169 | 94 | Selects poll rate for MPI. |
| 032 | TIMING PULSE | 186–227 | 207 | Sets baud rate for MPI. |
| 035 | HDMI1 ENABLE | 0–2 | 1 | Set to 0 to disable HDMI 1. Set to 1 (DTV Mode) or 2 (PC Mode), as applicable, to enable HDMI 1. |
| 039 | REAR AUX EN. | 0 / 1 | 1 | Set to 1 to enable display panel AV input jack. |
| 041 | SIMPLINK EN | 0 / 1 | 0 | Determines the status of the SIMPLINK feature. (See detailed descriptions.) |
| 042 | AUTO INPUTS | 0–255 | 0 | Determines the Aux inputs for which auto-sensing is enabled. (See detailed descriptions.) |
| 046 | STRT AUX SRCE | 1, 3, 5, 255 | 255 | Sets the starting Aux source (if item 004 STRT CHANNEL is set to 0). |

Installer Menu (Cont.)

Installer Menu Items 047 through 118

| Item | Function | Value Range | Default Value | Brief Description of Function |
|------|-----------------|-------------|---------------|---|
| 047 | AUX STATUS | 0 / 1 | 0 | Controls MPI status channel response for Aux sources. Set to 1 for the Aux source to be reported as its channel number. |
| 049 | DIS. AUDIO M. | 0–9 | 0 | Determines the availability of the Sound Out (Audio) Menu in the TV menus, as well as the default Audio Mode when TV is turned ON. (See detailed descriptions.) |
| 053 | DIS. CH-TIME | 0 / 1 | 0 | Set to 1 to disable the TV's native Channel-Time display. |
| 069 | EN. CH-T COL. | 0 / 1 | 1 | Set to 1 to enable custom color for MPI display characters. |
| 070 | FOR. CH-TIME | 0–7 | 2 | Chooses custom foreground color for MPI display characters. |
| 071 | BCK. CH-TIME | 0–7 | 2 | Chooses custom background color for MPI display characters. |
| 073 | CH NOT AVBLE | 0 / 1 | 0 | If set to 1 and item 028 CH. OVERRIDE is set to 0, a "CHANNEL NOT AVAILABLE" message is displayed if user attempts to direct tune a channel that is not included in the channel lineup. |
| 075 | REVERT CH | 0 / 1 | 0 | If set to 1 and loss of MPI communication occurs, TV tunes to Start Channel. |
| 077 | QUICK SHUTOFF | 0–17 | 0 | Allows TV to be turned OFF with press and hold of pillow speaker channel buttons. Set to 0 to disable. Set from 1 to 17 to define hold time. (See detailed descriptions.) |
| 078 | UPN MSB | 0–255 | 255 | User programmable number, most significant byte. |
| 079 | UPN MSB-1 | 0–255 | 255 | User programmable number, most significant byte - 1. |
| 080 | UPN MSB-2 | 0–255 | 255 | User programmable number, most significant byte - 2. |
| 081 | UPN LSB | 0–255 | 255 | User programmable number, least significant byte. |
| 082 | CHKSM ERROR | 0 / 1 | 1 | Enforces rigid MPI checksum. |
| 083 | HANDSHK TIME | 0–5 | 5 | Relaxes MPI timing to be compatible with PC-based Windows-controlled systems. |
| 084 | PERMANENT BLK | 0 / 1 | 0 | Removes block hours setting for Parental Control and makes block permanent. |
| 086 | V. MUTE TIME | 0–50 | 0 | Use to extend the normal video mute time during channel change. |
| 088 | EN NOISE MUTE | 0 / 1 | 1 | (Analog channels only) If set to 1, audio is muted if no signal is present. |
| 090 | KEY LOCK | 0 / 1 | 0 | If set to 1, all display panel joystick button functions are locked. IR is still functional. |
| 091 | HDMI2 ENABLE | 0–2 | 1 | Set to 0 to disable HDMI 2. Set to 1 (DTV Mode) or 2 (PC Mode), as applicable, to enable HDMI 2. |
| 094 | SAP MENU EN | 0 / 1 | 1 | Set to 1 to enable SAP feature in Function Menu. |
| 096 | DEF. ASP. RATIO | 0–4 | 2 | Sets default aspect ratio at power up. See detailed descriptions and item 106. |
| 097 | AUDIO OUTPUT | 0–9 | 7 | Set as required in accordance with external audio equipment connected to the TV. See detailed descriptions. |
| 098 | PRO:CENTRIC | 0–3 | 0 | Set to 0 to disable Pro:Centric operation. Set to 1 for Flash Mode. Set to 2 for GEM (Java Application) Mode. Set to 3 for HTML Mode. |
| 099 | BACK LIGHTING | 1–200, 255 | 255 | Sets the level of the TV picture back lighting. (See detailed descriptions.) |
| 101 | IR FEEDBACK | 0 / 2 | 0 | Set to 2 to disable the TV's MMR feature. |
| 102 | ATSC BAND | 0–4 | 4 | Selects ATSC band. |
| 103 | ATSC TUNE MODE | 0 / 1 | 1 | Set to 1 (default) for Physical Channel scan. Set to 0 for Virtual Channel scan. |
| 104 | START MINOR CH | 0–255 | 0 | Selects Minor Start Channel. Set to 0 for NTSC. |
| 106 | ASP RATIO LOCK | 0 / 1 | 0 | To retain set aspect ratio on power cycle, set to 1. Set to 0 for default ratio on power cycle. |
| 107 | BANNER SELECT | 0 / 1 | 1 | Selects the type of banner to display during channel change. |
| 116 | VIDEO MUTE EN | 0 / 1 | 0 | (Analog channels only) If set to 1, video mutes (blank screen) when no signal is present. |
| 117 | FACT DEFAULT | 0 / 1 | 0 | Set to 1 to restore the factory default settings of all Installer Menu items. |
| 118 | POWER SAVINGS | 1, 3, 7 | 3 | Determines the powered status of the embedded b-LAN module and the GAME CONTROL/MPI port. (See detailed descriptions.) |

Installer Menu (Cont.)

Installer Menu Items 119 through 122

| Item | Function | Value Range | Default Value | Brief Description of Function |
|------|----------------|-----------------|---------------|--|
| 119 | DATA CHANNEL | 0–135, 253, 255 | 255 | Set to 0 to disable. Set from 1 to 135 to match the RF channel number used by the Pro:Centric server as its data channel. Set to 255 to use Auto Search to find the Pro:Centric RF channel. (See detailed descriptions.) |
| 121 | UPDATE TIME HR | 0–23, 128 | 128 | Sets the Wake For Update hour. The value “128” is displayed as “OFF.” Directly entering 128 turns the Wake For Update feature OFF. |
| 122 | UPDATE TIME MN | 0–59, 255 | 0 | Sets the minute for Wake For Update. (See detailed descriptions.) |

Detailed Descriptions of Installer Menu Items

000 - INSTALLER SEQUENCE

Specifies entry sequence to the Installer Menu.

0 = 9876 1 = 4321
 2 = 1478 3 = 3698

001 - POWER MANAGE (Power Management)

Energy saving feature. Determines the number of hours, in the range 1 to 7, of inactivity allowed, either at the TV control panel or from the remote, before the TV automatically turns itself OFF. If set to 0, Power Management is disabled.

002 - AC ON (AC Power Switchable)

If set to 1, this allows the TV to turn ON when AC power is applied. Pressing the POWER button is not necessary. This is desirable if the TV is plugged into a switched AC outlet (i.e., a set-top box). Set to 2 or 3 to enable the Instant ON feature (see additional information below). Set to 0 (default) for standard TV turn ON/OFF operation.

The Instant ON feature allows the TV to turn ON when AC power is applied, but with video and audio muted (Muted ON). The TV retains its ON status while appearing to be OFF. Pressing the POWER button toggles Off/On the video and audio mutes, so that the TV appears to turn ON instantly.

- If this item is set to 2, the TV will reboot and, if applicable (i.e., item 119 DATA CHANNEL set from 1 to 135 or 253), check for and download any available updates from the Pro:Centric server at every turn OFF. This setting is not recommended if the TV will be configured with a resident application.
- If this item is set to 3, the TV will not reboot to check for and download updates at turn OFF, with the following exception: the first time the TV is turned OFF after this item is set to 3, the TV will reboot and initiate an update event (Data Channel Auto Search and/or check for and download of updates—see also paragraph below). This setting is recommended if the TV will be configured with a resident application. In this mode, the standard check for and download of updates is under application control. Refer to your site-specific documentation for further information on configuring the TV with a resident application.

When this item is set to 2 or 3, the TV also will reboot and initiate an update event once every 24 hours. During the update event, the TV, as applicable, performs a Data Channel Auto Search (item 119 set to 255) and/or checks for and downloads any available updates from the Pro:Centric server (item 119 set from 1 to 135 or 253). The time at which this event occurs depends on the setting of item 121 UPDATE TIME HR. See item 119 and 121 descriptions for further information. Once the update cycle is complete, the TV completes the reboot and resumes its Muted ON state.

Note: If set to 1, the TV does not respond to ON/OFF commands from either the remote or the display panel, and the SLEEP TIMER is also nonfunctional.

003 - BAND/AFC (Band/Automatic Frequency Control)

There are four possible settings for this option:

0 = Broadcast 1 = CATV (default)
 2 = HRC 3 = IRC

If some channels were not found by Auto Tuning (Channel Search), select the appropriate Band setting here, and add the channels using the Channel Edit option in the Channel Menu.

004 - STRT CHANNEL (Start Channel)

If active, this function allows you to determine the initial Major Start Channel number when the TV is turned ON. This feature is useful for an in-house information channel, since the TV would always select that channel when it is turned ON. If set to 255, the last channel tuned before the TV was turned OFF will be the channel tuned when the TV is turned ON again.

0 = Aux 127 = Map to Major CH 4
 1–125 = Major Ch. # 253 = IP Start Channel
 126 = Map to Major CH 3 255 = Last Channel

For a digital Start Channel, always remember to set item 104 to the Minor Start Channel number. If setting this item to 0 (Aux), make sure to also set item 046 STRT AUX SRCE to the appropriate value.

Note: 126 and 127 are mapped only in SONIFI PPV Mode.

Note: The IP Start Channel shown above can only be set in the FTG File Manager, which is used to configure TV CPUs for FTG Mode. The same applies for the additional Major Channel number range of 128–135 in Physical tuning and 128–999 in Virtual tuning mode. When the TV is in FTG Mode via CPU, the appropriate values will be visible in the (read-only) Installer Menu. For an IP Start Channel, item 004 will show value 253, the IP address, and the port number. For an RF Start Channel, item 004 will show the channel's Major and Minor numbers.

Note: If the TV is being configured for Application Tuning Mode operation with Pro:Centric Direct, the Start Channel is set in the Pro:Centric Direct Admin Client, and Installer Menu item 004 is automatically updated accordingly. When the TV is in Application Tuning Mode, the appropriate values will be visible in the (read-only) Installer Menu. For an IP Start Channel, item 004 will show value 253, the IP address, and the port number. For an RF Start Channel, item 004 will show the channel's Major and Minor numbers.

005 - CHAN LOCK (Channel Lock)

Channel Lock is ideal if the system must always be on the same channel. Changing channels with the Channel Up/Down or keypad numbers is impossible. Channel Lock is inactive if set to 0 (default).

Generally, this feature is used in connection with item 004 STRT CHANNEL where the Start Channel may, for example, be set to 3 or 4. If the Start Channel is 3, then the TV will remain locked on channel 3.

NOTE: For items 007, 008, and 009
For legacy reasons, the scale used is 0–63. The PTC software will translate this to the 0–100 scale used by the TV.

To translate a TV volume level to the Installer Menu value, use the following formula:

$$\text{Installer Value} = \frac{\text{TV Value} \times 63}{100}$$

Enter only the whole number (disregard fractions).

007 - STRT VOLUME (Start Volume)

This function allows the Installer to determine the initial volume level setting when the TV is turned ON. This feature is useful for an in-house information channel, since the TV will always select that volume level when it is turned ON. The range of values is 0 to 63, 255. If set to 255, the last volume level before the TV was turned OFF will be the current volume level when the TV is turned ON again.

008 - MIN VOLUME (Minimum Volume)

This function determines the minimum volume level allowable with the Volume (VOL) Up/Down control. In this way, for example, someone cannot set the volume too low to hear. The value range is from 0 to 63. The factory default is 0, which provides the full range of volume control, if item 009 MAX VOLUME is set to 63. It is recommended to set the same value on every TV.

Note: The minimum volume level cannot have a value setting higher than the maximum volume level (described below).

009 - MAX VOLUME (Maximum Volume)

This function determines the maximum volume level allowable with the Volume (VOL) Up/Down control. In this way, for example, someone cannot set the volume level high enough to disturb others. The value range is 0 to 63, with 63 as the default, which gives the user the full range of volume control, if item 008 MIN VOLUME is set to 0. It is recommended to set the same value on every TV.

Note: The maximum volume level cannot have a value setting lower than the minimum volume level (described above).

010 - MUTE DISABLE

Enables or disables sound mute function. If set to 1, sound cannot be muted. If set to 0, sound can be muted.

011 - KEY DEFEAT

If set to 1, Key Defeat is enabled, which means that end users cannot access or navigate within the on-screen menu(s) from the display panel; i.e., joystick button menu navigation functions will not be available. Set to 0 to disable Key Defeat. Note that all IR features remain functional regardless of this setting; users can always access the menus by pressing MENU on the remote.

012 - IR BANKS EN. (IR Banks Enable)

When enabled, you can direct access a particular channel bank by inputting the discrete IR code for that bank.

Note: This item is not available in the Installer Menu when item 027 HOSPITAL MODE is set to 0.

013 - SCAN MODE

When set to 1 (default), allows TV to be turned ON when Channel Up/Down buttons are pressed on pillow speaker. Also, TV will turn OFF when Channel Up/Down key is used to tune above or below Channel Map pivot point. By default, Channel Map pivot point is between the highest and lowest channel in the Channel Map (also see item 014 STRT CH IN SM). Set to 0 to disable.

Note: This item is only applicable when the TV is in PTC-CTV Mode or FTG Mode via CPU.

014 - STRT CH IN SM (Start Channel in Scan Mode)

Only valid when item 013 SCAN MODE is set to 1 (enabled). When set to 1, forces Channel Map pivot point to be between the RF channel designated in item 004 STRT CHANNEL and next lower channel in the Channel Map. Set to 0 to disable (default).

Note: This item is not available in the Installer Menu when item 013 SCAN MODE is set to 0.

015 - SLEEP TIMER

If set to 1, the Sleep Timer feature may be used. If set to 0, the Sleep Timer is not available.

Installer Menu (Cont.)

016 - EN TIMER (Enable On/Off Timers)

If set to 1, the Timer function is available to the end user and enabled continuously. Set to 0 to disable On/Off timers.

Note: The TV clock must be set in order for timers to be used.

017 - ALARM

Gives the installer the option of making the Alarm function available to the end user. If set to 1, the Alarm function is available to the end user. Set to 0 to disable the Alarm function.

Note: The TV clock must be set before the Alarm function will work.

020 - FEATURE LEVEL

Determines an additional IR code scheme to which the TV will respond, allowing for the use of unique IR codes based on “bed number” in a multi-TV single room installation. First determine the IR mode; then select the bed number.

Note: When item 027 HOSPITAL MODE is set to 0, both the IR code that will control the TV and the speaker selection are determined by this item (default = 1). Set this item as required to enable Zenith Bed 1 or Bed 2 IR codes and speaker selections.

| Values | IR Mode | Bed # | Speaker |
|--------|-------------------|-------|-------------|
| 0–1 | Zenith (Hospital) | 1–2 | TV Only |
| 16–24 | Multi-code Remote | 1–9 | TV Only |
| 64–65 | Zenith (Hospital) | 1–2 | Pillow Only |

Note: See Reference section, “LG Pro:Centric Patient Remote and Pillow Speaker,” for additional information. Also, see documentation for the accessory package that includes the multi-code remote.

021 - V-CHIP (Parental Control)

Set to 1 to activate V-Chip (Parental Control) and have it available to the end user to filter and control or otherwise restrict programming content that can appear. Set to 0 to turn the V-Chip feature Off (not available to user); no programming restrictions can be set.

022 - MAX BLK HRS (Maximum Block Hours)

Sets hours from 0 to 99 for the maximum V-Chip (Parental Control) block hours. Default setting is for 12 blocking hours.

Note: This item is not available in the Installer Menu when item 021 V-CHIP is set to 0 or when item 084 PERMANENT BLK is set to 1.

023 - CAPTION LOCK

If set to 0, captions are OFF when the TV is turned ON. Set to 1 to use the caption setting configured before the TV was turned OFF when the TV is turned ON.

025 - FUNCTION PRE (Function Preview)

Set to 1 to allow access to the Channel Preview/Banks Setup Menu via the CH PREVIEW key on Installer Remote. Set to 0 to disable access to the Channel Preview/Banks Setup Menu.

Note: This item is only applicable when the TV is in PTC-CTV Mode.

027 - HOSPITAL MODE

Set according to the speaker selection, the pillow speaker code/ supply voltage and the hospital IR code. If using a Pro:Centric pillow speaker, select one of the Zenith codes in accordance with the desired speaker selection. See table below.

When Hospital Mode is enabled, channel banks are also available. Refer to “Channel Banks Overview” on page 36 for further information.

Channel banks are not supported if Hospital Mode is set to 0 or on TVs that are configured for FTG Mode via EBL operation.

| Value | Speaker | Pillow Speaker Code/Voltage | Hospital IR Code |
|-------|--------------------------------|-----------------------------|--------------------------------|
| 000 | Determined by item 020 setting | Zenith (+12v) | Determined by item 020 setting |
| 001 | Pillow Only | Zenith (+12v) | Zenith Bed #1 |
| 002 | Pillow Only | Zenith (+12v) | Zenith Bed #2 |
| 017 | Pillow Only | Philips (+5v) | Zenith Bed #1 |
| 018 | Pillow Only | Philips (+5v) | Zenith Bed #2 |
| 033 | Pillow Only | RCA (-5v) | Zenith Bed #1 |
| 034 | Pillow Only | RCA (-5v) | Zenith Bed #2 |
| 065 | TV Only | Zenith (+12v) | Zenith Bed #1 |
| 066 | TV Only | Zenith (+12v) | Zenith Bed #2 |
| 081 | TV Only | Philips (+5v) | Zenith Bed #1 |
| 082 | TV Only | Philips (+5v) | Zenith Bed #2 |
| 097 | TV Only | RCA (-5v) | Zenith Bed #1 |
| 098 | TV Only | RCA (-5v) | Zenith Bed #2 |
| 129 | Both Pillow & TV | Zenith (+12v) | Zenith Bed #1 |
| 130 | Both Pillow & TV | Zenith (+12v) | Zenith Bed #2 |
| 145 | Both Pillow & TV | Philips (+5v) | Zenith Bed #1 |
| 146 | Both Pillow & TV | Philips (+5v) | Zenith Bed #2 |
| 161 | Both Pillow & TV | RCA (-5v) | Zenith Bed #1 |
| 162 | Both Pillow & TV | RCA (-5v) | Zenith Bed #2 |
| 254 | TV Only | Disabled (0v) | Zenith Bed #2 |

When Hospital Mode is set to 0 (disabled), both the IR code that will control the TV and the speaker selection depend on the Installer Menu item 020 FEATURE LEVEL setting.

Note: The default setting (254) is not selectable in the Installer Menu. If you ever need to restore the default setting, you must reload the factory default settings. See item 117 description and/or Reference section, “Restoring Factory Defaults on the TV(s),” for further information.

Note: In the Installer Menu, an informational code is displayed at the right of each Hospital Mode value. Each code consists of three characters. The first character—T, P, or B—identifies the speaker: TV, Pillow, or Both. The second character—Z, P, R, or D—identifies the pillow speaker code: Zenith, Philips, RCA, or Disabled. The third character—1 or 2—identifies the bed number. In the table above, each bolded character represents an element of the Hospital Mode code.

028 - CH. OVERRIDE (Channel Override)

This item either allows or restricts tuning of channels that are NOT in the PTC Channel Map. If set to 1, end users can tune channels that are not in the PTC Channel Map by direct keypad entry. If set to 0, users are restricted to only the channels that are in the PTC Channel Map. In the case of CPU-CTV Mode, there are no channels in the PTC Channel Map; therefore, direct keypad entry is not available. Also, when this item is set to 0, the PTC Channel Map (PTC-CTV Mode)/CPU channel lineup (CPU-CTV Mode) is locked, and user access to channel settings in the TV setup menus is restricted.

Note: This item is not applicable when the TV is in FTG Mode or Application Tuning Mode.

029 - OLD OCV (On Command Video™)

Set to 1 to remap the PTC's direct tune channels for Aux inputs from 13x to 9x. This allows 2-digit only tuning systems (i.e., legacy OCV) to direct tune Aux inputs. See also Reference section, "TV Aux Input Configuration."

030 - ACK MASK

MPI Communication Parameter. When set to 1, enables ACK feature of MPI.

031 - POLL RATE

MPI Communication Parameter. Selects poll rate for MPI. Step size of 16 ms. Changing from default may affect communication via MPI.

032 - TIMING PULSE

MPI Communication Parameter. Sets baud rate for MPI. Step size of 4.3 uS. Changing from default may affect communication via MPI.

035 - HDMI1 ENABLE

Set to 1 to enable HDMI 1 input in DTV Mode. Set to 2 to enable HDMI 1 input in PC Mode. Set to 0 to disable display panel HDMI 1 input.

039 - REAR AUX EN. (Rear Aux Enable)

Set to 1 to enable display panel rear Aux (AV) input. Set to 0 to disable display panel rear Aux (AV) input.

041 - SIMPLINK EN

Set to 0 to disable the SIMPLINK feature. Set to 1 to enable SIMPLINK functionality (does not enable remote control access to the SIMPLINK Menu).

Note: When both this item *and* item 042 AUTO INPUTS are enabled in the Installer Menu, HDMI inputs will be detected by SIMPLINK, but the Auto Input(s) Sensing Feature will not function.

042 - AUTO INPUTS

Determines the Aux inputs for which auto-sensing is enabled. Set to 0 to disable auto-sensing for all available inputs. Set to 255 to enable auto-sensing for all available inputs. For information on options for individual input settings, see Reference section, "Auto Input(s) Sensing Feature."

Note: In order for auto-sensing to be enabled for an input, that input must also be enabled in the Installer Menu. For example, to enable auto-sensing for HDMI 1, item 035 HDMI1 ENABLE must also be set to 1 or 2. Also, see note above regarding TV operation when both this item and item 041 SIMPLINK EN are enabled.

046 - STRT AUX SRCE (Start Aux Source)

Sets the starting Aux source. When turned ON, the TV will tune to starting Aux source if item 004 STRT CHANNEL is set to 0.

| | |
|------------|----------------|
| 1 = AV | 5 = HDMI 2 |
| 3 = HDMI 1 | 255 = Last Aux |

Note: In order for an Aux input to be selected as the starting Aux source, the input also must be enabled in the Installer Menu.

Note: This item is not available in the Installer Menu unless item 004 STRT CHANNEL is set to 0.

047 - AUX STATUS

Controls MPI status channel response for Aux sources. Set to 1 for the Aux source to be reported as its channel number. Set to 0 for the Aux source to be reported as channel 0. See Reference section, "TV Aux Input Configuration," for Direct Access channel numbers.

049 - DIS. AUDIO M. (Disable Audio Menu)

Determines the availability of the Sound Out (Audio) Menu in the TV menus. Also determines the default Audio Mode when TV is turned ON. See the table below and set as required.

| Value | Sound Out Menu Status | Default Audio Mode at TV Turn ON |
|-------------|-----------------------|-------------------------------------|
| 0 (default) | Enabled | TV Speaker |
| 1 | Disabled | TV Speaker |
| 2 | Enabled | External Speaker (Optical/HDMI ARC) |
| 3 | Disabled | External Speaker (Optical/HDMI ARC) |
| 4 | Enabled | LG Sound Sync (Optical) |
| 5 | Disabled | LG Sound Sync (Optical) |
| 6 | Enabled | LG Sound Sync (Wireless/BT) |
| 7 | Disabled | LG Sound Sync (Wireless/BT) |
| 8 | Enabled | TV Speaker + Audio Out (Optical) |
| 9 | Disabled | TV Speaker + Audio Out (Optical) |

Note: If a SIMPLINK-enabled device is connected to the TV and item 041 SIMPLINK EN is set to 1 (enabled), the SIMPLINK device Audio Mode will have priority over the setting of this item when the TV is turned ON.

Installer Menu (Cont.)

Note: Items 020 FEATURE LEVEL and 027 HOSPITAL MODE have priority over the setting of this item. Thus, if either item 020 or 027 is set to a Pillow Only value and this item is set to an internal TV speaker value, the pillow speaker setting will have priority, and you will not be able to hear sound from the TV speaker. You may however, set an external speaker configuration in conjunction with the pillow speaker.

Note: When this item is set to 6 or 7, the Bluetooth Sound Sync Media Share feature is not available. If Bluetooth Sound Sync is currently enabled in the IP Environment / Media Share Menu, it will be disabled.

053 - DIS. CH-TIME (Disable Channel-Time Display)

Set to 1 to disable the TV's native Channel-Time display when a custom channel label/channel information will be provided by the MPI command. Set to 0 to enable the TV's native Channel-Time display.

069 - EN. CH-T COL. (Enable Display Characters Custom Color)

Set to 1 to enable custom color for MPI display characters. Set to 0 to disable custom color for MPI display characters.

070 - FOR. CH-TIME (Display Characters Foreground Color)

Set the foreground color for MPI display characters according to the following color chart:

| | | | |
|-----------|-----------|------------|------------|
| 0 = Black | 2 = Green | 4 = Red | 6 = Yellow |
| 1 = Blue | 3 = Cyan | 5 = Violet | 7 = White |

If the foreground and background colors for the display characters are the same, the background will be transparent.

Note: This item and item 071 BCK. CH-TIME also apply to the "Channel Not Available" message if item 073 CH NOT AVBLE is set to 1 (enabled).

Note: Items 070 FOR. CH-TIME and 071 BCK. CH-TIME are only available in the Installer Menu when item 069 EN. CH-T COL. is set to 1.

071 - BCK. CH-TIME (Display Characters Background Color)

See description for item 070 FOR. CH-TIME above. The color chart is the same for both items.

073 - CH NOT AVBLE (Channel Not Available)

If set to 1 and item 028 CH. OVERRIDE is set to 0, a "CHANNEL NOT AVAILABLE" message is displayed when a user attempts to direct tune a channel that is not included in the channel lineup.

Note: This item is not available in the Installer Menu when item 028 CH. OVERRIDE is set to 1.

Note: This item is only applicable when the TV is in PTC-CTV Mode.

075 - REVERT CH (Revert to Start Channel)

If set to 1 and loss of MPI communication occurs, TV automatically tunes to the specified Start Channel.

Note: This item is not available in the Installer Menu when item 004 STRT CHANNEL is set to 255.

077 - QUICK SHUTOFF

Allows end user (patient) to turn OFF TV using mechanical (analog) Pillow Speaker Channel Up/Down buttons. Patient needs to press and hold either channel button for time determined by value set. Set to 0 to disable. Set from 1 to 17 to establish required hold time of button—from 2 seconds to 10 seconds in half-second increments.

Note: This item is not available in the Installer Menu when item 013 SCAN MODE is set to 0.

078 - UPN MSB (UPN Most Significant Byte)

User programmable number, most significant byte readable by MPI command. Note: Not linked to serial number.

079 - UPN MSB-1 (UPN Most Significant Byte-1)

User programmable number, most significant byte-1 readable by MPI command. Note: Not linked to serial number.

080 - UPN MSB-2 (UPN Most Significant Byte-2)

User programmable number, most significant byte-2 readable by MPI command. Note: Not linked to serial number.

081 - UPN LSB (UPN Least Significant Byte)

User programmable number, least significant byte readable by MPI command. Note: Not linked to serial number.

082 - CHKSM ERROR (Checksum Error)

Enforces rigid MPI checksum validation. Set to 1 for validation. Set to 0 to disable (does not check checksum on MPI async port). SPI is always checked.

083 - HANDSHK TIME (Handshake Time)

Adds an additional delay to the handshake time which is 64 msec, thus relaxing MPI timing requirements to be compatible with PC-based Windows controlled systems. Range is 0 - 5. (Timeout = 25.5MS + [25.5 MS* Handshake time].)

084 - PERMANENT BLK (Permanent Block)

Allows Lock (Parental Control) blocking schemes to be permanent by disabling the blocking hours function. Set to 1 to install Parental Control restrictions permanently. Set to 0 for user-specified hours control of blocking schemes.

Note: This item is not available in the Installer Menu when item 021 V-CHIP is set to 0.

086 - V. MUTE TIME (Video Mute Time)

Use to extend the normal video mute time during channel change. For example, you may wish to extend the normal video mute time to prevent the display of encrypted video (i.e., from a Pro:Idiom encrypted channel) that has not yet been decrypted. When set to 0, the normal video mute time is not extended. Set from 1 to 50 to increase the normal video mute time in 100 ms step increments up to a maximum of 5 seconds (e.g., the value of 25 represents 2.5 seconds, or 25 x 100 ms = 2.5 seconds).

088 - EN NOISE MUTE (Enable Noise Mute)

Applicable for analog channels only. If set to 1, audio mutes if no signal is present.

090 - KEY LOCK

If set to 1, Key Lock is enabled, which means that all display panel joystick button functions will be locked, i.e., non-functional. Set to 0 to disable Key Lock. Note that all IR features remain functional regardless of this setting.

091 - HDMI2 ENABLE

Set to 1 to enable HDMI 2 input in DTV Mode. Set to 2 to enable HDMI 2 input in PC Mode. Set to 0 to disable display panel HDMI 2 input.

094 - SAP MENU EN (2nd Audio Program)

Set to 1 to enable the SAP feature in the Function Menu, when the Function Menu is available (i.e., TV is not in Pass-through Mode). Set to 0 to disable the SAP feature in the Function Menu, when the Function Menu is available.

096 - DEF. ASP. RATIO (Default Aspect Ratio)

Selects default aspect ratio at power up:

0 = Set By Program 1 = 4:3
 2 = 16:9 (default) 3 = Just Scan
 4 = Zoom

Note: This item is not available in the Installer Menu unless item 106 ASP RATIO LOCK is set to 0.

097 - AUDIO OUTPUT

Determines availability and signal type/level (fixed speaker, variable speaker, or fixed line level [amplifier]) of the audio output to be used by external audio equipment connected to the SPEAKER OUT / LINE OUT jack on the TV. Set to 0 to disable audio output. Otherwise, see the table below and set as required in accordance with audio equipment. See also Reference section, "External Stereo Speaker Specifications."

| | Value | Status |
|----------------|-------|------------------|
| Speaker Output | 1 | Fixed 0.01 Watts |
| | 2 | Fixed 0.03 Watts |
| | 3 | Fixed 0.05 Watts |

| | | |
|-------------|---|---|
| | 4 | Fixed 0.10 Watts |
| | 5 | Fixed 0.20 Watts |
| | 6 | Fixed 0.50 Watts |
| | 7 | Fixed 1.00 Watt (default) |
| | 8 | Control with volume |
| Line Output | 9 | Fixed line level (typically 400 mVrms ± 100 mVrms @10KΩ) output |

098 - PRO:CENTRIC

Selects the Pro:Centric Application Mode. Set to 0 (default) to disable the Pro:Centric application. Set to 1 for Flash Mode. Set to 2 for GEM (Java Application) Mode. Set to 3 for HTML Mode.

The TV must be turned OFF for a few seconds to initiate the Pro:Centric application download. When the TV is turned back ON, it may take several minutes to load the Pro:Centric application after the initial download.

Note: This item is not available in the Installer Menu when item 119 DATA CHANNEL is set to 0.

099 - BACK LIGHTING

Sets the TV screen brightness at power up. Default setting is 255.

- 1 - 100 Static Back Lighting
(1 = Dimmest picture, 100 = Brightest picture)
- 101 - 200 Dynamic Back Lighting
(101 = Dimmest picture, 200 = Brightest picture)

If set between 101 and 200, the TV automatically controls back lighting depending upon the picture level of the current program. If set to 255, back lighting is controlled via the Picture settings in the TV setup menus.

101 - IR FEEDBACK

If set to 0 (default), the TV's MMR (Magic Motion Remote) feature is enabled, and a compatible LG MMR (not supplied) may be used with the TV. If set to 2, the MMR feature is disabled.

102 - ATSC BAND

Sets up TV to receive different types of incoming signals:

0 = Broadcast 1 = CATV 2 = HRC
 3 = IRC 4 = Same as NTSC

103 - ATSC TUNE MODE

Sets ATSC tuning mode. Default set to 1 for Physical Channel scan. Set to 0 for Virtual Channel scan.

104 - START MINOR CHANNEL

Sets Minor Start Channel number at power up. 0 = NTSC. If not 0, number selected is the digital channel's Minor Start Channel number.

Note: This item is not available in the Installer Menu when item 004 STRT CHANNEL is set to 0 or 255.

Installer Menu (Cont.)

106 - ASP RATIO LOCK (Aspect Ratio Lock)

Set to 1 to retain previous aspect ratio with power off. Set to 0 to retain default aspect ratio with power off. See item 096 DEF. ASP. RATIO above.

107 - BANNER SELECT

Selects the type of banner to display during channel change. Set to 1 for channel label display, plus channel information (full banner). Set to 0 for channel label display only (small banner).

116 - VIDEO MUTE EN (Video Mute Enable)

Applicable for analog channels only. If set to 1, video mutes (blank screen) when no signal is present.

117 - FACT DEFAULT (Factory Default)

Set to 1 and press OK to restore the factory default settings of all Installer Menu items. Once complete, the value returns to 0.



Caution: If set to 1, this clears all Installer Menu custom settings and restores the factory default settings. It also clears the channel lineup, including any assigned channel icons and custom text labels.

Note: See also Reference section, “Restoring Factory Defaults on the TV(s),” for further information.

118 - POWER SAVINGS

Default set to 3—the power circuitry for both the embedded *b*-LAN module and the GAME CONTROL/MPI port is only powered when the TV is turned ON. When the TV is turned OFF, the embedded *b*-LAN and the GAME CONTROL/MPI port are not powered.

Note that the TV must be turned ON in order to communicate with the embedded *b*-LAN module for configuration and control when POWER SAVINGS is set to 3. If POWER SAVINGS is set to 1, the *b*-LAN module is always powered.

Similarly, if MPI communication is required for external MPI control, POWER SAVINGS should be set to 1 so that the GAME CONTROL/MPI port circuitry is always powered.

Note: See Reference section, “*b*-LAN Setup & Overview,” for further information.



Caution: POWER SAVINGS should NEVER be set to 7. This setting is intended for factory use only.

119 - DATA CHANNEL

Set to 0 to disable. Set from 1 to 135 to match the RF channel number that will be used by the Pro:Centric server as its data channel.*

For TVs in Pass-through Mode or FTG Mode via CPU, if left at the default value (255), the TV's Data Channel Auto Search feature will be enabled (see additional information below).

Note: The Data Channel Auto Search feature is not available when the TV's EBL is in FTG Mode. If the DATA CHANNEL value is 255 when the TV is configured for FTG Mode via EBL, DATA CHANNEL is defaulted to 0.

Data Channel Auto Search feature: When this item is set to 255 (default), once every 24 hours, the TV will initiate a search of 10 predefined channels (10, 20, 30, ... 100) and then, if necessary, perform a complete search of the RF channels (1 to 135) in an attempt to find the RF channel used by the Pro:Centric server as its data channel. If the Pro:Centric RF channel is found, the DATA CHANNEL value will be changed from 255 to match the server's RF channel number. The time at which the Auto Search occurs depends on the setting of item 121 UPDATE TIME HR. See item 121 description for further information.

Note: Pro:Centric application updates are downloaded from the Pro:Centric server to the TV when the TV is turned ON; however, TV E-Z Installation updates are downloaded to the TV when the TV is turned OFF. While E-Z Installation updates are in progress, it is not possible to turn ON the TV.

Note: The Data Channel is automatically set to “253” if Media Type is set to “IP” in the EZ-Manager Wizard or Express Script or in the IP Environment / Pro:Centric Menu on the TV (see “LG First Use Wizard” on pages 17 to 18 or “Pro:Centric Setup” on pages 74 to 76, respectively) or if Installer Menu item #119 Data Channel is set to “IP Address” in the FTG File Manager, which is used to configure TV CPUs for FTG Mode operation. It is not possible to change the value to “253” directly in the Installer Menu.

121 - UPDATE TIME HR

Based on the settings of this item and item 122 UPDATE TIME MN, the Wake For Update feature wakes the TV once daily to check for and, if applicable, download updates from the Pro:Centric server.

Set the Wake For Update hour from 0 to 23. This item uses the 24-hour clock format. The value “128” (default) is displayed as “OFF.” Directly entering 128 resets the default value (OFF) for this item, though note that this setting does not mean the TV will not initiate update events—see additional information below.

Under standard TV OFF/ON operating conditions (i.e., item 002 AC ON is set to 0), a Wake For Update event occurs when the TV is OFF and causes the TV's CPU to temporarily turn ON, perform the update cycle, and then turn back OFF, all while the TV appears to be OFF. If item 002 AC ON is set to 2 or 3 for Instant ON, then the TV's CPU is always ON and Wake For Update occurs when the TV is in its Muted ON state (i.e., the TV only appears to be OFF). The Wake For Update event causes the TV's CPU to reboot in order to perform the update cycle and then return to its Muted ON state. See also description for item 002.

* PCS150R and later Pro:Centric servers do not support HRC or IRC cable channel frequencies.

Random Distribution of Update Time: If this item is set to 128 (OFF), the time at which a Data Channel Auto Search (item 119 set to 255) and/or an Instant ON update (item 002 set to 2 or 3) occurs is determined as follows: Each TV initiates the search and/or checks for updates during the 2 AM hour (if the TV clock is set) or after two hours of elapsed time from when AC power was applied (if the TV clock is not set). Also, in this case, a fixed update time minute from 0 to 59 that has been assigned to each TV is used. (The intention of this feature is to prevent all of the installed TVs from performing updates at the same time; however, note that in installations that have a large quantity of TVs with this feature, there will be some TVs that have the same update minute assignments.) The update time for the TV is displayed at the right of this item in the Installer Menu, for example:

121 UPDATE TIME HR OFF 02:34

If the TV display is ON when a Wake For Update event is to occur, the update will take place the next time the TV is turned OFF.

Note: This item is not available in the Installer Menu when item 119 DATA CHANNEL is set to 0, except when item 002 AC ON is set to 2 or 3 for Instant ON.

Note: The TV clock must be set in order for a Wake For Update event to occur at the precise time of day in accordance with item 121 and item 122 settings.

122 - UPDATE TIME MN

Set the Wake For Update minute from 0 to 59. If item 121 is NOT set to 128 and you wish to invoke the “random” minute assignment on the TV, set this item to 255. See also description for item 121 UPDATE TIME HR above.

Note: This item is not available in the Installer Menu unless item 121 UPDATE TIME HR is set from 0 to 23.

Note: The TV clock must be set in order for a Wake For Update event to occur at the precise time of day in accordance with item 121 and item 122 settings.

Custom Master TV Setup

This section describes how to create a customized Master TV Setup for cloning purposes when the TV is in Pass-through Mode. All cloning (export and import) processes on the TV are performed via USB memory device / “.tlx” file. The Master TV Setup may be exported to a Clone (.tlx) file, which can then be used (i.e., imported) to configure either TVs that are to remain in Pass-through Mode or TVs that are to be configured for FTG Mode via CPU.

Cloning requirements and procedures are described in detail on pages 57 to 63.

Note: You can also use the FTG File Manager to create an FTG Configuration (.tlx) file for FTG Mode via CPU configuration/cloning purposes, if desired (see pages 64 to 65). However, it is not possible to customize TV setup menu settings in the FTG File Manager. If you wish to include customized TV setup menu settings in the TV configuration, in addition to the channel lineup and Installer Menu settings, perform the Master TV Setup procedure to create a Clone (.tlx) configuration file.

Before You Begin

- It is recommended that you disconnect all Aux inputs if you intend to run Auto Tuning (Channel Search). Under certain conditions, Auto Tuning is disabled if there is an Aux input active.
- A Clone (.tlx) file comprises Installer Menu settings, IP Environment Menu settings (with the exception of unique TV attributes and settings), and all TV sources’ (analog, digital, AV, HDMI, etc.) clonable setup menu settings. See also “Clonable TV Setup Menu Features” list below.
- If the “.tlx” file (either a Clone or FTG Configuration file) to be imported on the Target TV(s) contains an FTG Channel Map, the Target TV(s) will be configured for FTG Mode via CPU, though as part of the import process, depending on the types of channels included in the Channel Map, you may have the option to select either logical or physical channel tuning. If you would like the Target TV(s) to remain in Pass-through Mode, the “.tlx” file should not include an FTG Channel Map.

Clonable TV Setup Menu Features

| | | |
|---|---|--|
| Picture Smart Picture Mode Picture Mode Settings | Channels Channel Tuning Channel Manager Channel Label | Accessibility Pointer Options Menu Transparency Closed Caption Audio Guidance TV Power Sound |
| Sound Smart Sound Mode Sound Mode Settings Volume Mode AV Sync. Adjustment | General Language Time & Date – Clock Mode (Auto/Manual) – Time Zone Timers (No Signal Power Off) Standby Light | |

Note: Some menu options vary between digital and analog channels and Aux inputs.

Note: The Quick Settings Menu is initially displayed when you press the **MENU** key on the Installer Remote. Select the **All Settings**  menu icon to access the advanced TV setup menus. Several advanced settings are duplicated in the Quick Settings Menu.

Custom Master TV Setup Procedure

1. Turn ON the TV.

The next step depends on whether the LG First Use Wizard appears on the screen when you turn ON the TV:

- If the wizard is displayed, the TV is in the required factory default state. To continue with this procedure, exit the wizard, and then proceed to step 2.

Note: If desired, you may also use the LG First Use Wizard / Express Script to create an Express Script TV Setup for cloning purposes. See “Express Script” on pages 28 to 37 for further information. Note that TV setup menu customization via the Express Script is limited to Channels Menu options.

- If the wizard is not displayed, restore the TV to a factory default condition before continuing with this procedure. See Reference section, “Restoring Factory Defaults on the TV(s),” as necessary, for further information.

2. Set Installer Menu items.

This step provides specific instruction only on the Installer Menu items that should be set on a Master TV. Refer to pages 42 to 53 for detailed information on all Installer Menu items.

- Use the Installer Remote to access the Installer Menu (see “Accessing the Installer Menu” on page 42 for further information).
- Set Installer Menu item **003 BAND/AFC**, as appropriate.
 - Broadcast: Set to 0.
 - CATV: Set to 1 (default).
 - HRC: Set to 2.
 - IRC: Set to 3.
- Set Installer Menu item **027 HOSPITAL MODE**, as appropriate, to select the speaker configuration.
- Set any other Installer Menu items that affect your TV programming network to the required configuration. For example, enable/disable Aux inputs, set a Start Channel, etc.
- After you have adjusted all Installer Menu item settings as required, and if you do not need to configure any IP Environment settings (see note below), press **OK** once on the Installer Remote to save your changes; then, press **OK** again to exit the menu.

Note: If you intend to configure settings in the IP Environment Menu, which is accessible from the Installer Menu, you can proceed directly to step 3. All Installer Menu settings will be saved automatically when you access the IP Environment Menu.

3. Configure IP Environment settings.

Note: You cannot return directly to the Installer Menu from the IP Environment Menu; thus, you may wish to set all Installer Menu items as needed before you access the IP Environment Menu. Otherwise, you will need to reaccess the Installer Menu to set additional items.

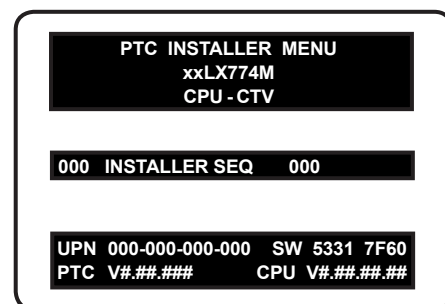

Typical Installer Menu



Adjust the values for these Installer Menu items, as required.

(Continued on next page)

Custom Master TV Setup (Cont.)

(Continued from previous page)

Navigate to Installer Menu item 119 DATA CHANNEL, and press **2-5-3 + MENU** to launch the IP Environment Menu. Then, complete network configuration as required. In particular, if you intend to use the Wi-Fi Zoning feature, you must configure the wireless network connection as part of the Master TV Setup. See “IP Environment Setup” on pages 70 to 78 for further information.

4. Set up TV features.

On-screen setup menus control the features of the TV. Press **MENU** on the Installer Remote, and select the **All Settings**  menu icon from the Quick Settings Menu to access the advanced TV setup menus. Then, set Picture, Sound, Channels, etc. options to the desired configurations. See “Clonable TV Setup Menu Features” list on page 54 and also notes below.

Note: If you intend to use the Zoning feature(s) on this TV, make sure to assign the appropriate TV Zone # and/or Wi-Fi Zone # at this time as described in Reference section, “Using the TV’s Zoning Features.”

Note: If desired and if appropriate, you can run Auto Tuning (see step 5) prior to completing this step.

5. (Optional) Run Auto Tuning.

If you are creating a Master TV Setup for cloning purposes and you want the Target TV(s) to remain in Pass-through Mode or Application Tuning Mode, as applicable, do NOT run Auto Tuning. If you export a Master TV Setup that includes an auto-tuned/edited channel lineup, thereby creating a Clone (.tlx) file with an FTG Channel Map, and then import the Clone file to a Target TV, this will put the Target TV in FTG Mode via CPU.

Note: When you import a Clone/Configuration (.tlx) file that contains an FTG Channel Map on a Target TV (for FTG Mode via CPU configuration), depending on the types of channels included in the Channel Map, you may have the option to select either logical or physical channel tuning. For either selection, the channel sequence will be based on the order in which the channels appear in the FTG Channel Map. You can view and/or edit the channel sequence in the FTG File Manager, as required.

- a) Use the Installer Remote to access the Channels Menu. Then, select **Channel Tuning** and follow the on-screen instructions to search for all available digital and analog channels.
- b) Use the **Channel Manager** option in the Channels Menu to edit the channel lineup, as necessary. Add/delete channels per your system requirements.

6. Verify the TV setup.

Make sure the TV features are set per your requirements. Also, if applicable, verify that the channel lineup is correct.

The Master TV Setup is now ready to be saved (exported) to a USB memory device. See “Cloning Procedures” on pages 57 to 63.

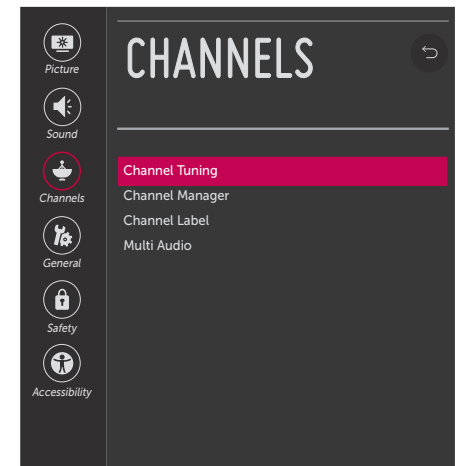
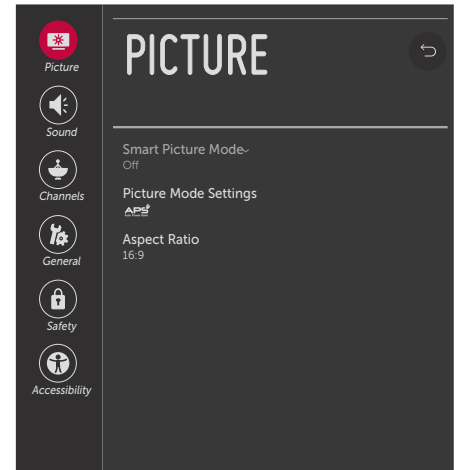

(Optional) Use Channels Menu options to run Auto Tuning and edit the channel lineup.

Cloning typically refers to the process of using a Master TV Setup to configure a Target TV. This section describes how to save (export) a Master TV Setup and then transfer (import) it to a Target TV using a USB memory device / Clone (.tlx) file.

You can also create an FTG Configuration (.tlx) file using the FTG File Manager and then use the Import Clone File procedure to transfer the configuration to Target TVs. Refer to “Creating an FTG Configuration File” on pages 64 to 65, as necessary.

Exporting a Clone File

This section describes how to use the TV Manager “Export Clone File” option to export Master TV Setup (including Express Script TV Setup) configuration to a USB memory device / Clone (.tlx) file.

Before You Begin

- Ensure the USB device has been formatted with FAT format.
- If applicable, complete the Custom Master TV Setup procedure (see pages 54 to 56).
- If you would like the Target TV(s) to remain in Pass-through Mode or Application Tuning Mode, as applicable, after the Clone file is imported, ensure the Master TV does not have an auto-tuned/edited channel lineup; otherwise, importing the exported file will result in the Target TV(s) being configured for FTG Mode via CPU.
- If you intend to use the TV’s Zoning feature(s), make sure to assign the appropriate TV Zone # and/or Wi-Fi Zone # as described in Reference section, “Using the TV’s Zoning Features,” BEFORE performing the procedure below. Also, for Wi-Fi Zoning in particular, the TV’s wireless network connection settings should be configured in the IP Environment Menu before exporting is initiated.
- It is not possible to clone a Master TV’s clock. Either set a Target TV’s clock manually, or use the Auto Clock setting in the TV setup menus.
- Since the Export Clone File process retrieves the channel lineup from the CPU, if the TV is currently in FTG Mode via EBL (FTG Channel Map resides in EBL), it is not possible to export an FTG Channel Map.



Caution: Do not unplug the TV power cord or remove the USB memory device while exporting is in progress, as doing so may cause the TV to malfunction or harm the USB device, respectively.

Export Clone File Procedure

1. Ensure the Master TV is set up completely and turned ON.
2. Insert the USB memory device into either of the USB ports on the Master TV.
3. Press **MENU** on the Installer Remote to display the TV setup menus (TV is in Pass-through Mode) or the Function Menu (TV is already in FTG Mode).
4. (TV in Pass-through Mode only) From the Quick Settings Menu displayed at the right of the screen, select the **All Settings**  menu icon and press **OK** to access the advanced TV setup menus.

(Continued on next page)

Cloning Procedures (Cont.)

(Continued from previous page)

5. Use the arrow navigation keys to select/highlight either the **General** menu icon from the TV setup menus or the **Safety** menu icon from the Function Menu. Then, press the number “7” key a total of seven times to access the TV Manager.

Note: Ez Download is always selected by default when you initially access the TV Manager. Also, note that Diagnostics is for service use only.

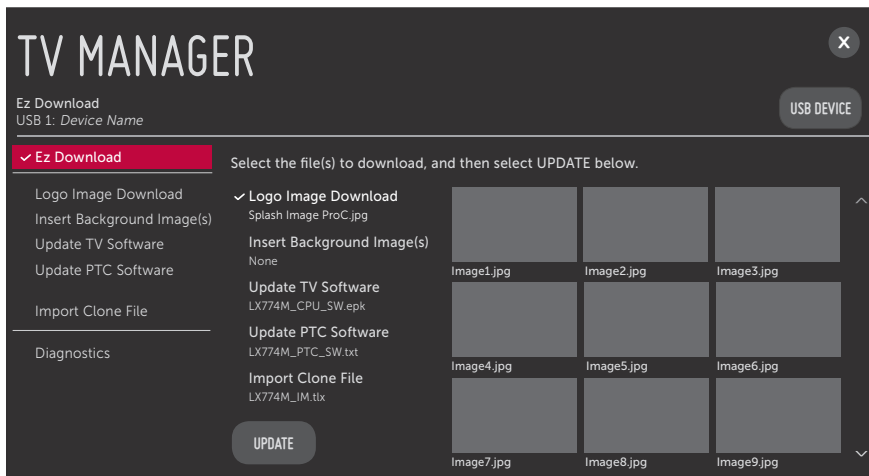

6. If more than one USB memory device is currently connected to the TV, be sure to select the USB device on which you wish to save the Clone file. If necessary, use the arrow keys on the Installer Remote to select/highlight the **USB DEVICE** button in the top right corner of the screen and press **OK**. Then, use the Up/Down arrow keys to select the appropriate USB device from the pop-up list of USB devices displayed at the top of the screen.



7. To gain access to the “Export Clone File” option in the TV Manager, key in the following number sequence on the Installer Remote: **9-8-7-6**.
8. Use the Up/Down arrow keys to select **Export Clone File**, and then press **OK**.
Clone filename parameters will be displayed on the screen (see example on following page).
9. Modify the filename, as required. While the TV model element of the filename may not be changed, you can differentiate this Clone file from other LX774M Clone files by changing the numeric assignment appended to the end of the filename. Select/highlight the filename, and then use the Up/Down arrow keys on the Installer Remote to scroll through numeric assignments until the desired number is shown.

(Continued on next page)

(Continued from previous page)

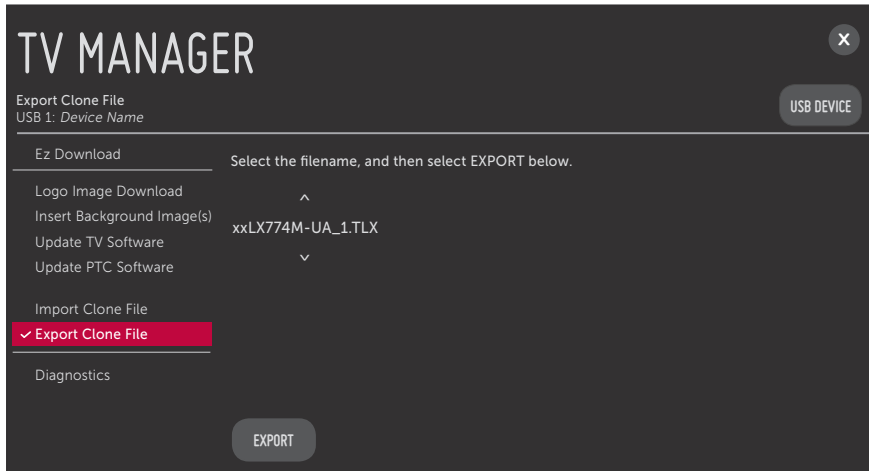

10. When you are ready to continue, i.e., when you have selected the desired filename, press **OK** on the Installer Remote to select/activate the **EXPORT** button at the bottom of the screen, and then press **OK** on the Installer Remote once more to export the file.

Export progress will be displayed on the screen. This process may take a few minutes. Do NOT remove the USB device while exporting is in progress. When the export process is complete, an EXPORT COMPLETE pop-up banner will be displayed at the bottom of the screen.

11. Press **OK** to return to the TV Manager screen. To return to program viewing, select the  button at the top right corner of the screen.
12. Remove the USB memory device from the Master TV.

 **Note:** If the Master TV has a channel lineup, during the export process, logical channel numbers are automatically assigned in ascending order, starting with 0 (zero), to the physical RF channels of the TV channel lineup to create an FTG Channel Map. See also note below.

 **Note:** If the exported Clone file is to be used for FTG Mode via CPU configuration (i.e., it contains an FTG Channel Map), it is highly recommended that you open the file in the FTG File Manager—BEFORE transferring (importing) the file to any Target TVs—to verify FTG Channel Map and FTG Installer Menu settings. This will also enable you to confirm channels and add channel attributes, labels, etc.

Importing a Clone File

This section describes how to transfer (import) a Clone or Configuration (.tlx) file from a USB memory device to a TV using the TV Manager “Import Clone File” option. The “.tlx” file may be created either from a Master TV Setup that was saved (exported) from a Master TV or in the FTG File Manager.

Before You Begin

- Ensure the USB device has been formatted with FAT format.

Cloning Procedures (Cont.)

- Avoid using special characters, such as ?, &, @, etc., in the Clone/Configuration (.tlx) filename.
- If you have initiated the EZ-Manager Wizard, you can use the wizard's "USB Configuration" option to access the TV Manager and complete the import procedure, if desired (see "TV Configuration Options" and/or "USB Configuration" on pages 20 and 26, respectively, as necessary).
- You may also use the Ez Download utility to import the Clone/Configuration (.tlx) file. See "Ez Download Utility" on pages 38 to 41 for further information.
- If the Target TV is currently in Pass-through Mode and you intend to use the TV's Zoning feature(s)—i.e., the Clone/Configuration (.tlx) file you are importing contains an FTG Channel Map and/or FTG profile(s) with TV Zone and/or Wi-Fi Zone assignments—make sure to assign the appropriate TV Zone # and/or Wi-Fi Zone # in the TV when directed to do so in the procedure below. See Reference section, "Using the TV's Zoning Features," for further information.
- If you would like the Target TV(s) to remain in Pass-through Mode or Application Tuning Mode, as applicable, after the Clone/Configuration (.tlx) file is imported, ensure the ".tlx" file does not contain an FTG Channel Map; otherwise, the import procedure will result in the Target TV(s) being configured for FTG Mode via CPU.
- If a Clone (.tlx) file (exported Master TV Setup) contains an FTG Channel Map, the physical RF channels in the FTG Channel Map have been assigned logical channel numbers (see "Exporting a Clone File" above). When you import the Clone file with the FTG Channel Map on the Target TV(s), you will have the option to select either logical or physical channel tuning. Even if you select physical channel tuning, the (list of) physical RF channels in the FTG Channel Map will remain in logical order.
- If an FTG Configuration (.tlx) file (created in the FTG File Manager) contains an FTG Channel Map, each logical channel number in the FTG Channel Map has been assigned a physical RF channel, an IP channel, or an Aux input (the latter designated by 130-0 through 137-0—see also Reference section, "TV Aux Input Configuration").

Note: If the FTG Channel Map includes RF channels and Aux inputs *only*, when you import the FTG Configuration file on the Target TV(s), you will have the option to select either logical or physical channel tuning. If you select physical channel tuning, the physical RF channels and Aux inputs in the FTG Channel Map will remain in logical order. Physical channel tuning is not available when the FTG Channel Map includes IP channels.

- If the Target TV EBL is already in FTG Mode, you cannot use this procedure to make changes to the FTG Channel Map and FTG Installer Menu settings. You must use a direct PC-to-TV connection as described in Reference section, "FTG Mode via EBL (Local Configuration)," or an FMA head end device to reconfigure the EBL.
- If the preceding condition applies, but you wish to switch the TV to FTG Mode via CPU, see Reference section, "Restoring Factory Defaults on the TV(s)," for further information before proceeding.
- If the Clone/Configuration (.tlx) file was edited/created in the FTG File Manager, it may contain multiple zoned FTG Installer Menu profiles for different TV models. Make sure it includes the appropriate Installer Menu profile(s) for the Target TV(s) before performing the procedure below.



Caution: Do not unplug the TV power cord or remove the USB memory device while importing is in progress, as doing so may cause the TV to malfunction or harm the USB device, respectively.

Import Clone File Procedure

1. Turn ON the Target TV.
2. The next step depends on whether the LG First Use Wizard appears on the screen when you turn ON the TV:
 - If the wizard is displayed, you can complete the import procedure via the EZ-Manager Wizard, as indicated above (see “Before You Begin”). However, to continue with this procedure and access the “Import Clone File” option from the TV menus, exit the First Use Wizard. Then, continue with step 3.
 - If the wizard is not displayed, go directly to step 3.
3. If applicable (see also “Before You Begin” above), make sure to assign the appropriate Zone designation(s) in the Target TV at this time.



Note: In order for the proper location-specific TV Zone and/or Wi-Fi Zone profile data to be applied, the Zone designation(s) must be assigned in the Target TV(s) BEFORE importing is initiated.

4. Insert the USB memory device with the Clone/Configuration (.tlx) file into either of the USB ports on the Target TV.
5. Press **MENU** on the Installer Remote to display the TV setup menus (TV is in Pass-through Mode) or the Function Menu (TV is already in FTG Mode).
6. (TV in Pass-through Mode only) From the Quick Settings Menu displayed at the right of the screen, select the **All Settings**  menu icon and press **OK** to access the advanced TV setup menus.
7. Use the arrow navigation keys to select/highlight either the **General** menu icon from the TV setup menus or the **Safety** menu icon from the Function Menu. Then, press the number “7” key a total of seven times to access the TV Manager.

Note: Ez Download is always selected by default when you initially access the TV Manager. Also note that Diagnostics is for service use only.

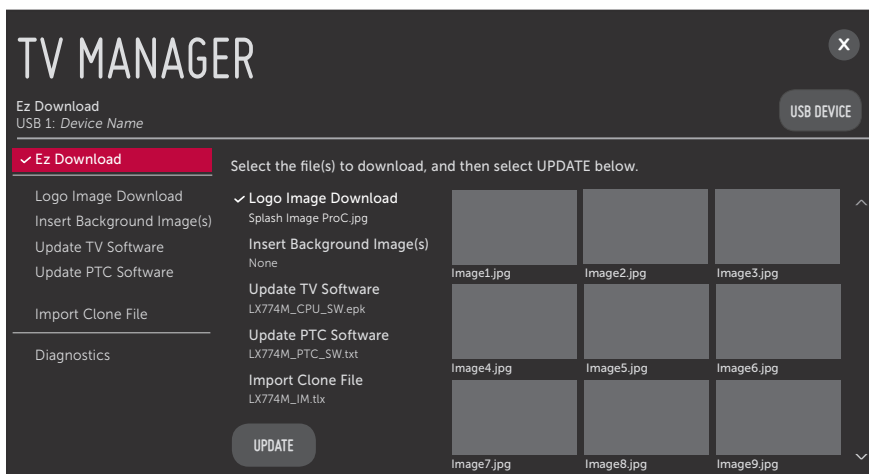

(Continued on next page)

Cloning Procedures (Cont.)

(Continued from previous page)

- If more than one USB memory device is currently connected to the TV, be sure to select the USB device that contains the “.tlx” file you wish to use. If necessary, use the arrow keys on the Installer Remote to select/highlight the **USB DEVICE** button in the top right corner of the screen and press **OK**. Then, use the Up/Down arrow keys to select the appropriate USB device from the pop-up list of USB devices displayed at the top of the screen.



- Use the Up/Down arrow keys to select **Import Clone File**, and then press **OK**.
A list of the “.tlx” files stored in the root folder of the USB memory device will be displayed on the screen.

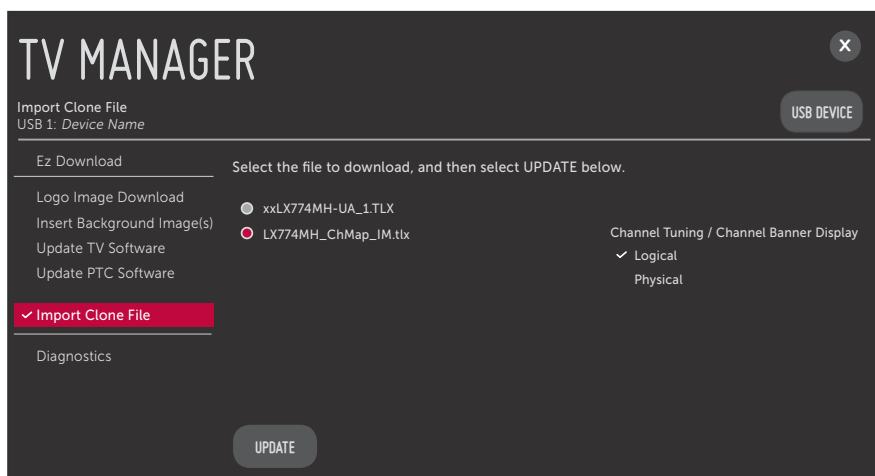

- Use the arrow keys on the Installer Remote to select/highlight the “.tlx” file to import, and then press **OK**.

Note: Filenames of exported Clone files are comprised of the TV model and a numeric element, for example, xxLX774M-UA_1.TLX.

- If the Clone/Configuration (.tlx) file includes an FTG Channel Map with RF channels and Aux inputs *only*, you can choose the format for the channel tuning/banner display. Use the arrow keys to select the desired Channel Tuning / Channel Banner Display option—either Logical or Physical—at the right side of the screen. A checkmark will appear at the left of the selected option. Logical tuning is selected by default.

Note: If an FTG Channel Map includes IP channels, only logical tuning is available. Also, if the “.tlx” file does not include an FTG Channel Map, the message, “No Channel Map in Clone file,” will be displayed at the right of the screen.

(Continued on next page)

(Continued from previous page)

12. When you are ready to continue, select **UPDATE** on the screen and then press **OK** on the Installer Remote.

Import progress will be displayed on the screen. This process may take a few minutes. Do NOT remove the USB device while importing is in progress. When the import process is complete, an IMPORT COMPLETE pop-up banner will briefly be displayed at the bottom of the screen, and then, the TV will reboot.

13. Remove the USB memory device from the Target TV, and verify that the appropriate configuration is now resident on the Target TV.

Note: If the Target TV was previously in Pass-through Mode, and the Clone/Configuration (.tlx) file that was imported contained an FTG Channel Map, the Target TV CPU is now in FTG Mode. Upon restart, the TV tunes according to the Start Channel setting in the Installer Menu. If a Start Channel is specified, the TV will tune to that channel, though, in the case of FTG Mode via CPU configuration, a channel banner will only be displayed if the Start Channel is included in the FTG Channel Map (depending on your selection in step 11, the channel banner will display either the Start Channel's logical channel number or physical RF channel number). Otherwise, the TV will either return to the last channel tuned (TV in Pass-through Mode) or tune to the first channel in the FTG Channel Map (TV in FTG Mode via CPU). If the latter, remember that the channels in the FTG Channel Map are always arranged in logical order, regardless of your selection in step 11.

FTG File Manager Utilities Overview

As indicated in the introduction to this document, there are two separate and distinct methods for configuring LX774M TVs for FTG Mode of operation: one method is to configure the TV CPU for FTG Mode operation, while the other is to configure the TV EBL for FTG Mode operation. FROM A LOCAL CONFIGURATION STANDPOINT, EACH OF THESE METHODS IS MUTUALLY EXCLUSIVE. IF THE CPU IS IN FTG MODE, THE EBL CANNOT BE SWITCHED TO FTG MODE. LIKEWISE, IF THE EBL IS IN FTG MODE, THE CPU CANNOT BE SWITCHED TO FTG MODE.

This section provides an overview of the FTG File Manager, which is used for FTG Mode via CPU configuration. The software is available online at: www.lg.com/us/business/display-solutions/ftg.

Creating an FTG Configuration File

The procedure below describes how to use the FTG File Manager utilities (see sample screens on pages 66 to 69) to create an FTG Configuration (.tlx) file that can be saved to a USB memory device. In order to enable decryption of Pro:Idiom encrypted channels, it is recommended that you create or view/edit an FTG Configuration file using the FTG File Manager.

Note: There is also an option to save (export) FTG Configuration from a TV, which may be desirable or required if you want to save customized TV setup menu settings to the FTG Configuration file and/or if you do not know the RF channels at the site. See “Exporting a Clone File” on pages 57 to 59 for further information.

This procedure provides an overview of the steps required to create an FTG Configuration (.tlx) file. Refer to the ***Free-To-Guest (FTG) File Manager User Guide*** for further information.

1. Install (if necessary) and launch the FTG File Manager (v1.3.8 or later) on the PC that will be used to create the FTG Configuration (.tlx) file.
2. You have a number of options:
 - To view and/or base a new FTG Configuration file on an existing FTG Configuration (.tlx) file, click the **Open** button in the TLX File command section of the FTG File Manager main screen, and select/double-click on the desired “.tlx” file.

A list of the file’s contents will be displayed in the TLX File Contents window. Either double-click on an individual item to copy it, or click the **Copy All** button directly above the TLX File Contents window to automatically copy all the contents of the opened file to the FTG Configuration List and, if applicable, Setup Menu List. Note, though, that while TV setup menu settings can be included in the new FTG Configuration file, the TV setup menu settings are not available for editing.

Edit the configuration of the items in the FTG Configuration List as well as the FTG Configuration List itself and/or the Setup Menu List, as necessary, to create a new file. Then, proceed to step 3 when you are ready to continue.

- To open an existing FTG Configuration (.rml) file created in the FTG Device Configuration Application to use its FTG Channel Map and/or FTG Installer Menu settings, click **File** and then **Open** from the FTG File Manager menu bar, and select/double-click on the desired “.rml” file.
Edit channels and/or settings as necessary. Then, proceed to step 3 when you are ready to continue.
- Create a new FTG Channel Map using the FTG Channel Map Editor in the FTG Channel Map Configuration Utility. Up to 600 channels (combined total of both RF and IP mapped channels) can be defined in the FTG Channel Map.

When you are ready to continue, click **Configure** and then **FTG File Manager** from the FTG File Manager menu bar to return to the FTG File Manager main screen, and then proceed to step 3.

(Continued on next page)

FTG File Manager Utilities Overview (Cont.)

(Continued from previous page)

Note: To remove an individual item from the FTG Configuration List or the Setup Menu List, click on/highlight the item to be removed, and then click the **Remove Item** button directly above the applicable “List” window. To clear both the current FTG Configuration List and Setup Menu List contents, click the **Clear** button in the List command section of the FTG File Manager main screen.

Note: To clear the current TLX File Contents, click the **New** button in the TLX File command section of the FTG File Manager main screen (above the TLX File Contents window).

3. To add an FTG Channel Map to the FTG Configuration List, click **>>** under FTG Channel Map. This will copy the current mapped RF and IP channels to the FTG Configuration List.

Note: If you make any change(s) in the FTG Channel Map Configuration Utility to the current data to be included in the FTG Configuration List, you will need to recopy the FTG Channel Map to the FTG Configuration List.

4. (Optional) Load default FTG Installer Menu settings for the TV. In the Installer Menu Templates section of the FTG File Manager main screen:

- If it is not already selected, click the down arrow at the right of the Region field, and select **North America**. Then, click the down arrow at the right of the Chassis field, and select the appropriate chassis from the drop-down list of available models.
- Click the **Load** button.
- Use the FTG Installer Menu Configuration Utility to modify settings, if necessary, including Media Share settings, Wi-Fi Zoning settings, etc. Then, return to the FTG File Manager main screen.

5. If you wish to change the Zone assignment for the current FTG Installer Menu settings, click on the down arrow at the right of the Zone field (below the FTG Installer Menu Settings field), and select the appropriate Zone (0–8). See Reference section, “Using the TV’s Zoning Features,” for further information on the TV Zoning feature and setting the TV Zone # in the TV(s).

6. To add FTG Installer Menu settings to the FTG Configuration List, click **>>** under FTG Installer Menu Settings. This will copy the selected model’s settings to the FTG Configuration List.

Note: If you make any change(s) in the FTG Installer Menu Configuration Utility to the current data to be included in the FTG Configuration List, you will need to recopy the FTG Installer Menu settings to the FTG Configuration List.

Note: Above both the FTG Configuration List and Setup Menu List windows, an Edit Zone field enables you to change the Zone assignment for each LX774M Installer Menu and/or Setup Menu profile, if desired. Select/highlight the desired profile, and then click on the down arrow at the right of the applicable Edit Zone field to select the appropriate Zone.

7. Click the **Save** button in the List command section of the FTG File Manager main screen to save the FTG Configuration List and, if present, Setup Menu List contents to an FTG Configuration (.tlx) file on the PC’s hard drive for later use.

In the Save As pop-up window, name the file (avoid using special characters, such as ?, &, @, etc.) and click **Save**. The default folder path is C:\Program Files\Zenith\FTG\TLX. Note that the FTG Configuration file will have a “.tlx” file extension.

Note: To remove an individual item from the FTG Configuration List or the Setup Menu List before saving the new file, click on/highlight the item to be removed, and then click the **Remove Item** button directly above the applicable window. To clear both the current FTG Configuration List and Setup Menu List contents, click the **Clear** button in the List command section of the FTG File Manager main screen.

8. Transfer the FTG Configuration (.tlx) file to a USB memory device, and proceed to “Importing a Clone File” on pages 59 to 63 to transfer the FTG Configuration file to an LX774M TV.

FTG File Manager Utilities Overview

FTG File Manager Main Screen

The FTG File Manager main screen enables you to compile, modify, and save FTG Configuration (.tlx) files. It also allows you to change the Zone assignment for each Installer Menu profile, if desired (see Reference section, "Using the TV's Zoning Features," for further information).

The screenshot shows the FTG File Manager application window with the following sections and callouts:

- FTG CONFIGURATION LIST**: Data to be saved in FTG Configuration (.tlx) file. This points to the 'List' section containing 'FTG Configuration List' and 'Setup Menu List'.
- CLEAR/SAVE**: FTG Configuration and Setup Menu List options. This points to the 'Clear' and 'Save' buttons in the 'List' section.
- NEW/OPEN**: TLX File options. This points to the 'New' and 'Open' buttons in the 'TLX File' section.
- Filename of opened FTG Configuration (.rml) file created using FTG Device Configuration Application.**: This points to the 'FTG File' text input field.
- Copy FTG Channel Map to and from FTG Configuration List.**: This points to the 'FTG Channel Map' section with '0 Mapped RF Channels' and '0 Mapped IP Channels'.
- Copy FTG Installer Menu settings to and from FTG Configuration List. Assign Zone as applicable.**: This points to the 'FTG Installer Menu Settings' section showing '120-1: 32/43/55LX774M (Items Default)' and a 'Zone' dropdown.
- Load default FTG Installer Menu for LX774M chassis.**: This points to the 'Installer Menu Templates' section with 'Region: North America' and 'Chassis: Select Model'.
- SETUP MENU LIST**: Data to be saved in FTG Configuration file. This points to the 'Setup Menu List' table.
- TLX FILE CONTENTS**: Data contained in opened FTG Configuration (.tlx) file. This points to the 'TLX File Contents' table.



Note: The data referenced in the FTG Configuration List is only a snapshot of the current FTG Channel Map and FTG Installer Menu settings when copied to the list. If you make any change(s) to the current data to be included in the FTG Configuration List, you will need to recopy Channel Map and Installer Menu settings to the FTG Configuration List.

FTG File Manager Utilities Overview (Cont.)

FTG Channel Map Configuration Utility

The FTG Channel Map Configuration Utility enables you to create, view, edit, and print a Logical Channel Map.

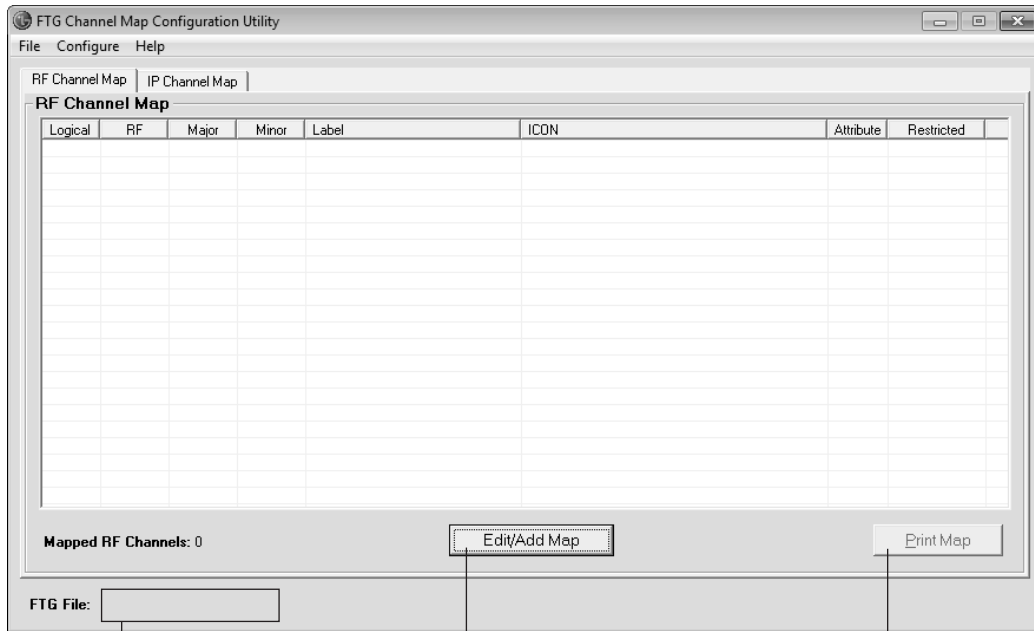

Filename of opened FTG Configuration (.rml) file created using FTG Device Configuration Application.

EDIT/ADD MAP

Click to open the FTG Channel Map Editor to create or edit an FTG Channel Map (see next page).

PRINT MAP

Click to display a printable FTG Channel Map Report. The report can also be exported as an HTML or Text file.

FTG File Manager Utilities Overview (Cont.)

FTG Channel Map Editor

The FTG Channel Map Editor shows a single Logical Channel's data and the FTG Channel Map.

LOGICAL CHANNEL MAPPING

Select a Logical Channel number. Then, assign the RF, Major, and Minor channel numbers to complete the mapping.

CUSTOM CHANNEL LABELS/ICONS

Enter custom labels and select icons by name on menu or by number.

SET CHANNEL ATTRIBUTES

Check/select Encrypted, OSD, or Blank Video.

| Logical | RF | Major | Minor | Label | ICON | Attribute | Restricted |
|---------|----|-------|-------|---------|-----------------------------------|-----------|------------|
| 1 | 84 | 84 | 1 | CBS | 14 - CBS | EO | |
| 2 | 20 | 20 | 5 | NBC | 15 - NBC | EO | |
| 3 | 81 | 81 | 1 | CNN | 5 - CNN | EO | |
| 4 | 18 | 18 | 1 | ABC | 13 - ABC | EO | |
| 5 | 19 | 19 | 3 | PBS | 17 - PBS | EO | |
| 6 | 68 | 68 | 1 | MAX | 47 - Cinemax | EO | |
| 7 | 81 | 81 | 2 | ESPN | 2 - ESPN | EO | |
| 9 | 61 | 61 | 1 | HDNet | 161 - HDNet | EO | |
| 10 | 64 | 64 | 1 | Nat Geo | 145 - National Geographic Channel | EO | |
| 18 | 65 | 65 | 1 | Comedy | 36 - Comedy Central | EO | |
| 19 | 62 | 62 | 2 | TBS | 3 - TBS | EO | |
| 20 | 19 | 19 | 1 | WGN | 89 - WGN | EO | |
| 23 | 86 | 86 | 3 | TNT | 4 - TNT | EO | |
| 24 | 62 | 62 | 2 | HBO2 | 168 - HBO 2 | EO | |
| 25 | 59 | 59 | 2 | HBO | 12 - HBO | EO | |

ZONE RESTRICTION

Set Zone (TV not in Hospital Mode) or channel bank (TV in Hospital Mode) restriction(s) for channel. See note below.

UPDATE

After editing an existing Logical Channel's data, click to commit the changes in the FTG Channel Map.

ADD

After defining a new Logical Channel, click to add channel to the FTG Channel Map.

DELETE

Click to remove highlighted channel from FTG Channel Map.

EXIT

Click to exit editor and return to FTG Channel Map Configuration Utility.

Note: The application of FTG Channel Map Zone restrictions in the TV (see Zone Restriction section in this screen) depends on the setting of Installer Menu item 027 HOSPITAL MODE (see item 027 description on page 48 for further details). If Installer Menu item 027 is set to 0, Hospital Mode is disabled, and TV Zoning / FTG Channel Map Zone restrictions may be set, as in Lodging models (see also Reference section, "Using the TV Zoning Feature"). When Hospital Mode is enabled, you can use Zones 1 to 4 to create custom channel lineups for Channel Banks 1 to 4 (see also "Channel Banks Overview" on page 36). In the latter case, a checked Zone Restriction (1 to 4) checkbox means that the selected channel is "deleted" from the same numbered channel bank.

FTG Installer Menu Configuration Utility

CONFIGURATION SETTINGS

Select tabs for categories of Installer Menu items to set up TV.

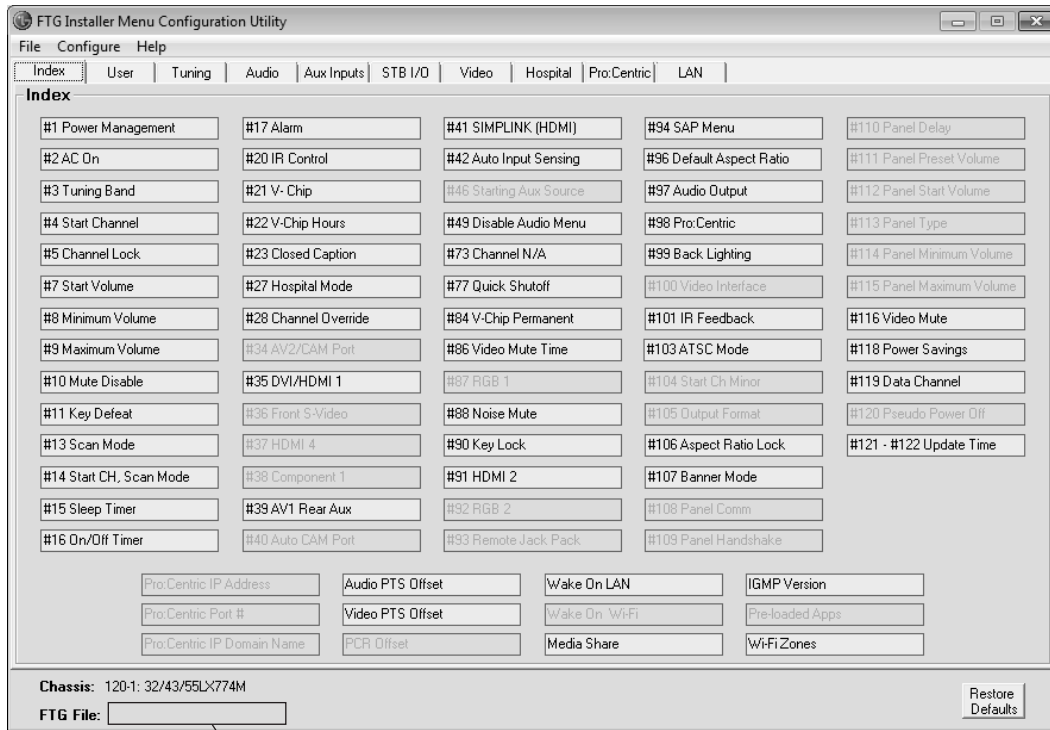

Filename of opened FTG Configuration (.rml) file created using FTG Device Configuration Application.

Note: The Pro:Centric tab enables you to set up Pro:Centric-specific parameters. The LAN tab enables you to set up a variety of LAN features, including the Wi-Fi Zoning feature. Refer to the *Free-To-Guest (FTG) File Manager User Guide* for further information. Also, see Reference section, “Using the TV’s Zoning Features,” for additional information on Wi-Fi Zoning.

IP Environment Setup

The IP Environment Menu enables you to set up the network features of the TV. If you intend to create a Master TV Setup for cloning purposes (see Master TV Setup procedure on pages 47 to 49), all IP Environment settings, with the exception of Wired Network Connection settings, the TV name (editable in the Media Share Menu), DIAL, and SoftAP settings, may be cloned.

Note: With the exception of Network Setting configuration, the IP Environment settings are editable (with the Installer Remote) only if the TV is in Pass-through Mode and read-only when the TV is not in Pass-through Mode.

Accessing the IP Environment Menu

Note: When you enter the IP Environment Menu, the Installer Menu is exited (all current settings are saved automatically upon exit). If you are also in the process of updating Installer Menu items, you may wish to set all items as needed before you access the IP Environment Menu. Otherwise, after exiting the IP Environment Menu, you will need to reaccess the Installer Menu to set additional items.

1. Use the Installer Remote to access the Installer Menu (see “Accessing the Installer Menu” on page 42 for further information).
2. Navigate to Installer Menu item 119 DATA CHANNEL, and press **2-5-3 + MENU** to launch the IP Environment Menu.

Use the Up/Down arrow keys on the Installer Remote to select the desired menu option and then press **OK**. Refer to the following sections for information on each of the IP Environment setup options.

When you have completed your IP Environment configuration as required, press **EXIT** or **↩** on the Installer Remote to exit the IP Environment Menu.

Network Configuration

This section describes each of the options available in the Network Menu (see example at right). Refer to the appropriate subsection(s) on the following pages.

 **Note: If you intend to use the Wi-Fi Zoning feature with cloning configuration, you must configure the wireless network connection as part of the Master TV Setup. See “Configuring a Wi-Fi Network Connection” on page 72 for further information.**

Accessing the Network Menu

With the IP Environment Menu on display, use the arrow keys on the Installer Remote to select the **Network** menu option. Then, press **OK**.

Note: The TV's MAC address is displayed at the top of the Network Menu screen and cannot be modified.

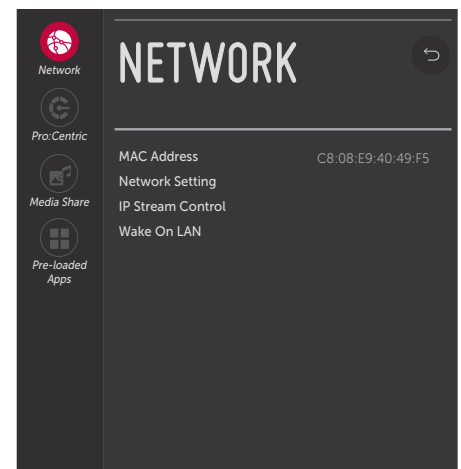

Configuring a Wired Network Connection

Note: If desired, you can configure both wired and wireless connections. However, note that a wired connection is always prioritized over a wireless connection. That is, when the TV is turned OFF and then back ON, if a LAN cable is detected between the TV and the network, the TV will default to the wired connection. If the LAN cable is removed, the TV will then attempt to establish the wireless connection. Whenever the LAN cable is reconnected, the TV will re-establish the wired connection.

1. Connect the appropriate cable between the TV and the network.
2. With the Network Menu on display, use the arrow keys on the Installer Remote to select **Network Setting**. Then, press **OK**. A second Network screen (see example at right), with Wired and Wi-Fi Connection setup options, will be displayed.

By default, the TV uses DHCP, and if a LAN cable is detected, the TV will attempt to connect to the network as soon as you select “Network Setting” above. If the TV is able to connect to the network, a “Connected to Internet” message will be displayed below the Wired Connection field.

3. If the network is not configured for DHCP or you want to specify static configuration data or you would like to change the network configuration from Manual to Automatic, edit the IP configuration for this TV as follows:
 - In the second Network screen, select **Wired Connection** and press **OK**. Then, in the Wired screen, select **Edit** (if not already selected) and press **OK**.
 - In the Edit IP screen, select or de-select the “Set Automatically” checkbox, as required. A checkmark indicates that Automatic configuration is enabled.
 - To manually edit the IP configuration, for each data entry field: Use the arrow keys on the Installer Remote to select the field and press **OK**. You can use the number keys on the Installer Remote to direct enter numeric values or use the arrow keys to select the appropriate numbers from the pop-up virtual keyboard displayed at the bottom of the screen. (Note, however, that you must use the dot “.” key from the virtual keyboard to separate each octet of an IP address.) When you are done, select **Enter** from the virtual keyboard, and then press **OK** on the Installer Remote.
 - When all Edit IP fields are set as required, use the arrow keys on the Installer Remote to select **Connect** and press **OK**.

At the top of the screen, you will see a progress display that indicates status as each network element is confirmed (see example at right).

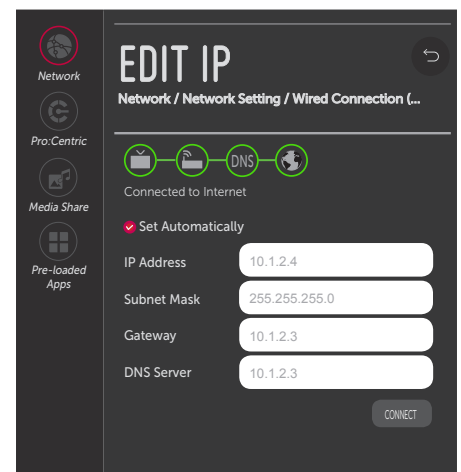
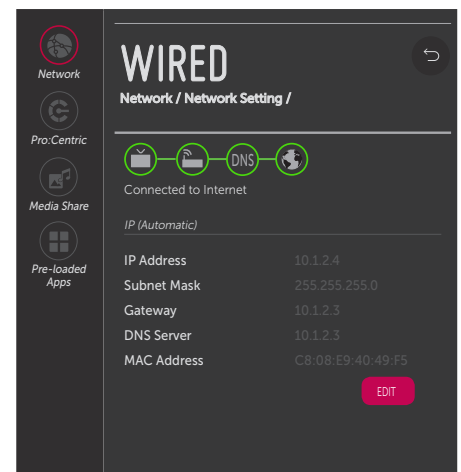
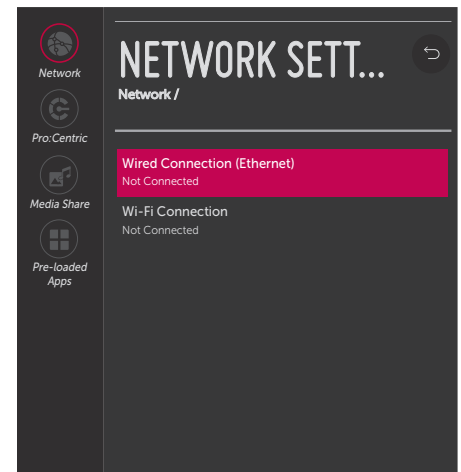

(Continued on next page)

IP Environment Setup (Cont.)

(Continued from previous page)

If the network is connected successfully, a “Connected to Internet” message will appear just below the progress display. If the network connection is not successful, the progress display will identify the network element in which the connection failed. Check your cabling and/or verify the configuration data, as necessary.

4. Once the wired network configuration is complete, use the arrow keys on the Installer Remote to return to the IP Environment Menu, as necessary, or press ↵ to return to the previous Network Menu level(s) and/or exit the IP Environment Menu.

Configuring a Wi-Fi Network Connection

1. With the Network Menu on display, use the arrow keys on the Installer Remote to select **Network Setting**. Then, press **OK**.
2. A second Network screen (see example at right), with Wired and Wi-Fi Connection setup options, will be displayed. Select **Wi-Fi Connection** and press **OK**.
3. In the Wi-Fi screen, available access points are listed in the top half, while additional menu options are listed in the bottom half, of the screen. Use the arrow keys on the Installer Remote to select the desired access point, or select the type of wireless connection to configure (see descriptions below). Then, press **OK**.
 - Add a hidden wireless network: Direct enter the SSID of an access point whose SSID has not been enabled for broadcast (i.e., the access point does not appear in the list of access points).
 - WPS PBC: Connect to a network via an access point that is enabled for PBC.
 - WPS PIN: Complete network/PIN verification via the access point web interface.

Make sure you have the network security password/PIN available if you are attempting to connect to a secured network.

4. Follow the on-screen instructions to complete the appropriate network configuration. Use the Installer Remote to navigate between fields and make entries, etc.

Note: As with a wired connection, you will have the option to specify the IP configuration for this network connection. Once the initial connection is established, you can select **Advanced Settings** (initially greyed out) at the bottom of the Wi-Fi screen to view the IP configuration data. In the Advanced screen, select **Edit** and press **OK**, and then modify the IP data, as required. See step 3 of the wired connection procedure above for further information on the Edit IP screen fields.

5. Once the wireless network configuration is complete, use the arrow keys on the Installer Remote to return to the IP Environment Menu, as necessary, or press ↵ to return to the previous Network Menu level(s) and/or exit the IP Environment Menu.

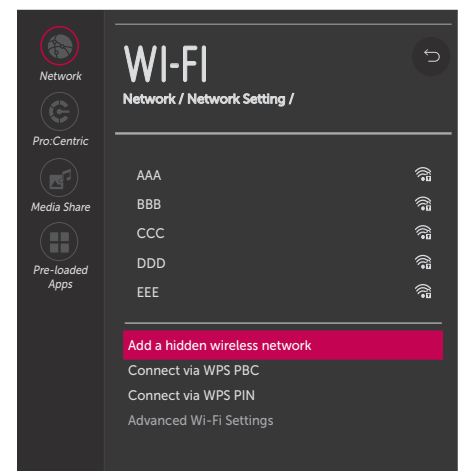
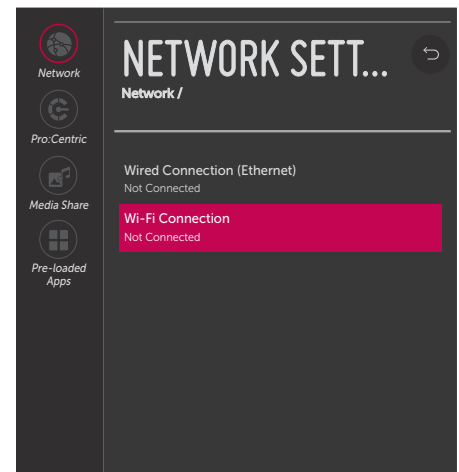

IP Stream Control

If necessary, due to an audio and/or video stream delay, IP Stream Control options enable you to compensate for synchronization irregularities by allowing audio PTS and video PTS offset modifications. This menu also enables you to specify the IGMP version (2 or 3). Note that any modifications to these settings should be performed by qualified personnel only.

1. With the Network Menu on display, use the arrow keys on the Installer Remote to select **IP Stream Control**. Then, press **OK**.
2. In the IP Stream Control screen, use the Up/Down arrow keys on the Installer Remote to select/highlight the appropriate field—Audio PTS Offset, Video PTS Offset, or IGMP Version—and then press **OK**.
3. If you are modifying an offset value, use the Left/Right arrow keys to select the appropriate value for the selected field. Offset values represent offset time in milliseconds (ms) and can be adjusted from -500 ms to +500 ms in 10 ms increments. When you are done, press **OK** on the Installer Remote.

If you are modifying the IGMP version, use the Up/Down arrow keys to select the appropriate version number from the drop-down list of options, and then, press **OK**.

4. Once all modifications are completed as required, use the arrow keys on the Installer Remote to return to the IP Environment Menu, as necessary, or press ↵ to return to the Network Menu and/or exit the IP Environment Menu.

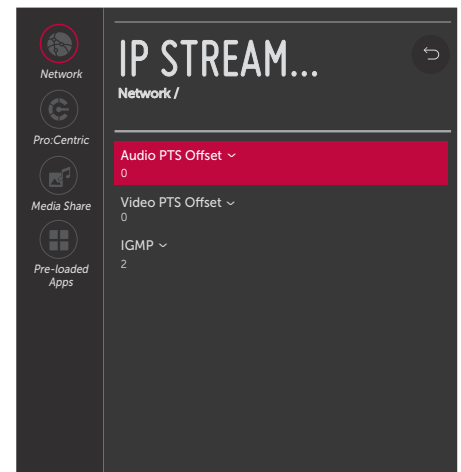

Wake On LAN Setup

The Wake On LAN feature enables the TV to receive software updates and/or be powered ON upon receipt of Wake Up Frame packets and/or Magic Packet data via the wired LAN. To facilitate use of this feature, note that the appropriate wired connection must be made. This menu option enables you to specify Wake On LAN parameters.

1. With the Network Menu on display, use the arrow keys on the Installer Remote to select **Wake On LAN**. Then, press **OK**.
2. In the Wake On LAN screen, use the Up/Down arrow keys on the Installer Remote to select/highlight the desired field and press **OK**. Then, use the arrow keys to select the desired setting—Disabled, Update, or Power On—from the drop-down list of options.
3. Once all fields are completed as required, use the arrow keys on the Installer Remote to return to the IP Environment Menu, as necessary, or press ↵ to return to the Network Menu and/or exit the IP Environment Menu.

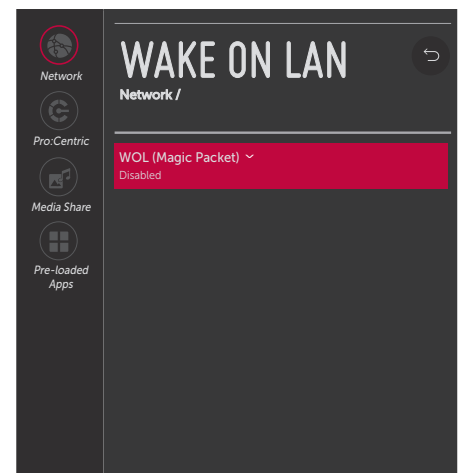

IP Environment Setup (Cont.)

Pro:Centric Setup

Pro:Centric options enable you to configure the TV with the appropriate settings to connect to the Pro:Centric server. Use the Up/Down arrow keys on the Installer Remote to navigate between fields.

1. With the IP Environment Menu on display, use the arrow keys on the Installer Remote to select the **Pro:Centric** menu option. Then, press **OK**.
2. Select/highlight the **Media Type** field and press **OK** on the Installer Remote to display the drop-down list of options. Then use the Up/Down arrow keys to select either **RF** or **IP**, as applicable.

Note: If the Media Type has already been set in the EZ-Manager Wizard or Express Script, the specified value will be reflected in this field.

3. Refer to the appropriate subsection below to configure the TV's Pro:Centric settings to match those of the Pro:Centric server.

While the Pro:Centric application itself is an additional feature (see step 4), the appropriate Pro:Centric server configuration must be completed to enable TV E-Z Installation (splash screen, configuration, and software/firmware) data downloads and, if configured, the Pro:Centric application download.

RF Configuration

For TVs in Pass-through Mode or FTG Mode via CPU, if the Data Channel is left at its default value (AUTO), the TV's Data Channel Auto Search feature will be enabled. See Installer Menu item 119 DATA CHANNEL description on page 52 for further information.

To change the Data Channel setting, select/highlight the **Data Channel** field and press **OK** on the Installer Remote. Then, use the Up/Down arrow keys to select either **MANUAL** or **AUTO** from the drop-down list of options.

When the Data Channel field is set to "MANUAL," a data entry field is available on the screen, and you can specify the RF channel number that will be used by the Pro:Centric server as its data channel. The Data Channel value can be set from 0 (disabled) to 135.* Use the arrow keys on the Installer Remote to select the Data Channel data entry field and press **OK**. You can then use the number keys on the Installer Remote to direct enter the Data Channel, or you can use the arrow keys to select the appropriate number(s) from the pop-up virtual keyboard displayed at the bottom of the screen. When you are done, select **Enter** from the virtual keyboard, and then press **OK** on the Installer Remote.

Note: If the Data Channel has already been set in the Installer Menu (Installer Menu item 119) or in the EZ-Manager Wizard or Express Script, the specified channel will appear in the Data Channel data entry field. If you change the Data Channel in this menu, Installer Menu item 119 will now show the value you entered here.

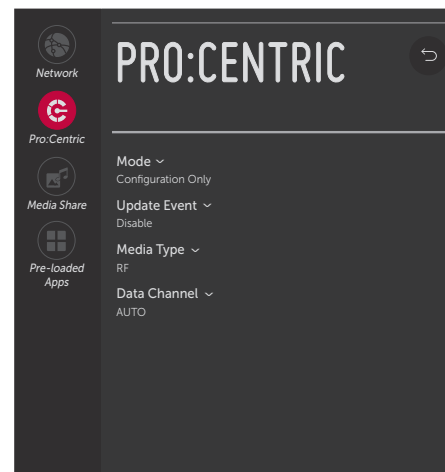

Note: By default, the Pro:Centric Menu initially shows RF configuration fields. When "IP" is selected as the Media Type, Server Address and either IP Address and Port Number or Domain Name and Port Number fields appear on the screen (in place of the Data Channel field).

(Continued on next page)

* PCS150R and later Pro:Centric servers do not support HRC or IRC cable channel frequencies.

(Continued from previous page)

IP Configuration

Note: If the server IP address and port number or domain name have already been set in the EZ-Manager Wizard or Express Script, the specified data will be reflected in the fields displayed.

Note: Setting the Media Type to “IP” automatically sets item 119 DATA CHANNEL in the Installer Menu to 253. You cannot alter this setting unless you revert Media Type to “RF.” Also, it is not possible to direct enter “253” in the Installer Menu.

- a) The Server Address field provides the option to specify the domain name of the Pro:Centric server instead of the server’s IP address. Select/highlight the **Server Address** field and press **OK** on the Installer Remote. Then, use the Up/Down arrow keys to select either **IP Address** or **Domain Name** from the drop-down list of options for defining the server.
- b) Depending on your selection in the previous step, either:
 - Enter the Pro:Centric server IP address in the IP Address field. The IP address must match the IPv4 multicast address that is set in the Pro:Centric server.
 - Enter the Pro:Centric server domain name in the Domain Name field. Note that in order for the domain name to be resolved to an IP address, there must be a DNS entry for the domain name.

For each data entry field: Use the arrow keys to select the field and press **OK**. Then, you can either use the number keys on the Installer Remote to direct enter data values, or you can use the arrow keys to select the appropriate number(s)/alphanumeric character(s) from the pop-up virtual keyboard displayed at the bottom of the screen. When you are done, select **Enter** from the virtual keyboard, and then press **OK** on the Installer Remote.

- c) Enter the Pro:Centric server port number in the Port Number field. The port number must match the port number that is set in the Pro:Centric server.
4. Select/highlight the **Mode** field and press **OK** on the Installer Remote to display the drop-down list of options. Then, use the Up/Down arrow keys to select the appropriate Pro:Centric Application Mode setting—**Configuration Only**, **FLASH**, **GEM**, or **HTML**. If the Pro:Centric Application Mode is set to “Configuration Only,” Pro:Centric application data will not be downloaded.

Note: If the mode has already been set in the Installer Menu (item 098 PRO:CENTRIC) or in the EZ-Manager Wizard or Express Script, the specified mode will be reflected in this field. If you change the mode in this menu, Installer Menu item 098 will now reflect the value you selected here.
 5. Select/specify the appropriate Update Event setting(s), as required. Based on Update Time settings, the Wake For Update feature wakes the TV once daily to check for, and if applicable, download updates from the Pro:Centric server. See Installer Menu item 121 UPDATE TIME HR description on page 52 for additional information on Wake For Update functionality.
 - Select/highlight the **Update Event** field and press **OK** on the Installer Remote. Then, use the Up/Down arrow keys to select either **Enable** or **Disable** from the drop-down list of options. When Update Event is set to “Enable,” an Update Time field is displayed on the screen.

(Continued on next page)

IP Environment Setup (Cont.)

(Continued from previous page)

- If Update Event is enabled, set the Update Time as required. Use the arrow keys on the Installer Remote to select/highlight the Update Time field, and then press **OK**. Hour, Minute, and Meridiem fields will be displayed. Select each field in turn and specify the appropriate Wake For Update time, as desired. Note that the Update Time set in this menu is based on a 12-hour clock. Ensure the meridiem (AM/PM) specification is set accordingly.
6. Once all fields are completed as required, use the arrow keys on the Installer Remote to return to the IP Environment Menu, as necessary, or press **↵** to exit the IP Environment Menu.

Media Share Setup

The Media Share Menu allows you to enable the following Media Share features on this TV:

- **LG Smart Share®**: Allows guests to use the TV to access and view data shared either by wired DLNA Certified® devices connected to the same LAN as the TV or by wireless LG devices using LG's Smart Share application with Wi-Fi Direct®.
- **Screen Share**: Enables screen sharing with a Miracast® or Wireless Display (WiDi) capable device (e.g., a laptop with Intel® hardware).
- **Media Renderer**: Enables the TV to act as a media renderer to receive content from DLNA Certified devices on the same network.
- **Bluetooth Sound Sync**: Allows guests to listen to audio from a Bluetooth-enabled mobile device through the TV's speakers.
- **DIAL (Discovery and Launch)**: Allows guests to play selected application media on the TV from a device with DIAL capability. The device may be used to cast any application for which a TV-compatible application has been created/selected for inclusion in the Pre-loaded Apps Menu (for example, YouTube—see also "Pre-loaded Applications" on page 78). Note that the device must be connected to the same network as the TV.
- **SoftAP**: Enables the TV to function as a 2.4 GHz wireless access point for up to five devices. Note that a wired network connection **MUST** be established in order for guests to use SoftAP.

Note: See also Reference section, "Using Media Share Features," for additional information on these features.

1. With the IP Environment Menu on display, use the arrow keys on the Installer Remote to select **Media Share**. Then, press **OK**.
2. In the Media Share Menu, all features with the exception of SoftAP may be enabled or disabled as follows:
 - Use the Up/Down arrow keys on the Installer Remote to select/highlight the desired feature, and then press **OK**.
 - Then, use the Up/Down arrow keys to select either **Enable** or **Disable** from the drop-down list of options. See also notes on following page regarding Wi-Fi Direct requirement and Bluetooth Sound Sync confirmation.

(Continued on next page)

(Continued from previous page)

3. If you would like to enable SoftAP, complete the SoftAP access configuration as follows:

- Select/highlight **SoftAP** and press **OK** on the Installer Remote.
- When you initially access the SoftAP screen (see example at right), the OFF/ON toggle button at the top right of the screen is selected/highlighted by default. Press **OK** on the Installer Remote to turn SoftAP ON.
- To enable use of a randomly generated security key for SoftAP access, set the Use Default field to “Enable” (the Security Key field will subsequently be grayed out and the random security key will be displayed).
- To specify your own security key for SoftAP access, set the Use Default field to “Disable.” Then, select the **Security Key** field and press **OK**. In the data entry field, you can use the number keys on the Installer Remote to direct enter a numeric security key, or you can use the arrow keys to select the appropriate alphanumeric characters—at least eight, but no more than 64—from the pop-up virtual keyboard displayed at the bottom of the screen. Note that the security key may not contain any special characters (:, /, \, @, etc.). When you are done, select **Enter** from the virtual keyboard, and then press **OK** on the Installer Remote.
- Select the appropriate values in the Wi-Fi Signal Strength, and Wi-Fi Channel fields, as required.

4. If desired, you can specify a name for this TV so that it is easy to identify and differentiate from other TVs for which sharing has been/will be enabled.

Note: By default, the TV name is the TV’s serial number. However, if a room number is specified in the EZ-Manager Wizard or in the General Menu / Room Info screen, the TV name is changed to the room number.

To edit the TV name, use the Up/Down arrow keys to select the **TV Name** field, and then press **OK**. You can then use the number keys on the Installer Remote to direct enter a numeric TV name, or you can use the arrow keys to select the appropriate alphanumeric character(s) from the pop-up virtual keyboard at the bottom of the screen. When you are done, select **Enter** from the virtual keyboard, and then press **OK** on the Installer Remote.

5. Once all fields are completed as required, use the arrow keys on the Installer Remote to return to the IP Environment Menu, as necessary, or press ↵ to exit the IP Environment Menu.

Note: While Smart Share, Screen Share, Media Renderer, and Bluetooth Sound Sync settings are clonable, DIAL and SoftAP settings, as well as the TV name cannot be cloned.

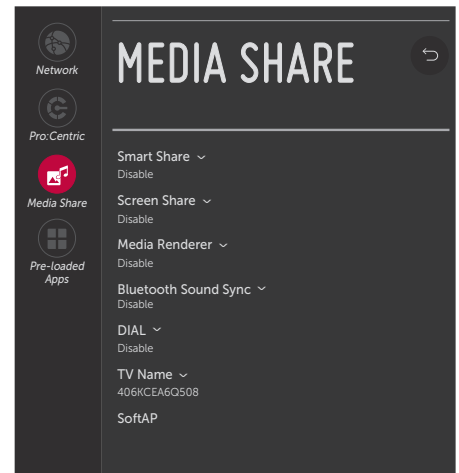

Notes:

- Screen Share MUST be enabled in addition to Smart Share in order for guests to use Wi-Fi Direct.
- If you enable Bluetooth Sound Sync, a pop-up confirmation banner will be displayed since enabling Bluetooth Sound Sync renders Wireless LG Sound Sync unavailable. Select **Yes** to continue.

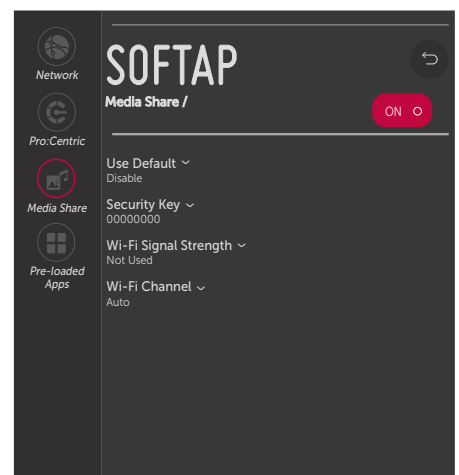

IP Environment Setup (Cont.)

Pre-loaded Applications

This option allows you to select which of the pre-loaded application icons to display in the TV's Smart Launcher, which appears along the bottom of the screen.

When the Pro:Centric application is disabled, the Smart Launcher is available to end users via the PORTAL button on the remote control. The Smart Launcher is also available to end users via the SMART button on the remote control.

1. With the IP Environment Menu on display, use the arrow keys on the Installer Remote to select **Pre-loaded Apps**. Then, press **OK**.
2. In the Pre-loaded Apps screen, a list of available application options is displayed. Use the Up/Down arrow keys to highlight each application you wish to select or de-select, and press **OK** on the Installer Remote. When an application is selected, a checkmark is displayed at the left of the application name.

Note: Though not included in the application list on this screen, Screen Share, Bluetooth Sound Sync, and SoftAP (as Wi-Fi Service) applications are available in the Smart Launcher once they are enabled in the Media Share Menu. See "Media Share Setup" above.

3. When you are done selecting the pre-loaded application icons to be displayed in the Smart Launcher, as required, use the arrow keys on the Installer Remote to return to the IP Environment Menu, as necessary, or press **↩** to exit the IP Environment Menu.

Note: While pre-loaded application selections are clonable, it is not possible to edit pre-loaded application selections in the FTG File Manager. Thus, if a TV has already been configured for FTG Mode via CPU and you would like to add or remove applications, you will need to import a new ".tlx" file with the appropriate model profile. That is, you will need to use a Master TV of the same model to create and export a ".tlx" file with the desired pre-loaded application selections (along with any other applicable Installer Menu settings), which can be transferred (imported) to the Target TV.

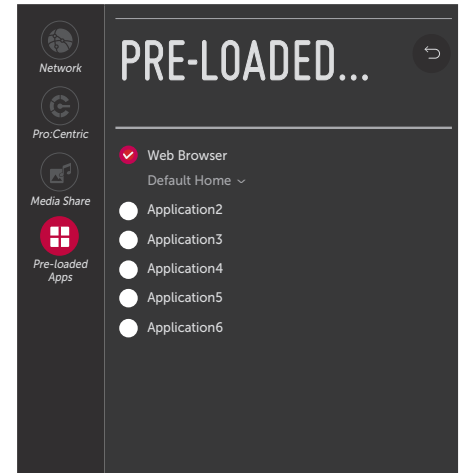

Notes:

- Make sure to select any application(s) that may be used in conjunction with the DIAL feature, if applicable.
- If desired, with the Web Browser application, you may specify the default home page.

Reference: Updating TV/PTC Software using a USB Memory Device

This section describes how to update TV (CPU) and/or PTC software using the TV Manager “Update TV Software” and/or “Update PTC Software” option(s), respectively, though you may also use the Ez Download utility to update software, if desired. See “Ez Download Utility” on pages 38 to 41 for further information.

Before You Begin

- Software update files must be stored in a folder named “LG_DTV” in the root directory of the USB memory device.
- Ensure the USB device has been formatted with FAT format.

Update the TV/PTC Software

Note: You can check the TV/PTC software versions by accessing the Installer Menu with the Installer Remote. See “Accessing the Installer Menu” on page 42 for further information. PTC and CPU versions are displayed in the Installer Menu footer.

Note for TV CPU Software Update only: If the TV detects a software file on the USB device, it will automatically display an Update TV Software screen, and if the file contains a later version of software than is currently running on the TV, you can start the software update from this screen (select **UPDATE** and press **OK**). Otherwise, you can exit the screen (select **CANCEL** and press **OK**), and access the TV Manager as described below.

1. Turn ON the TV, and then insert the USB memory device into either of the USB ports on the TV.
2. Press **MENU** on the Installer Remote to display the TV setup menus (TV is in Pass-through Mode) or the Function Menu (TV is not in Pass-through Mode).
3. (TV in Pass-through Mode only) From the Quick Settings Menu displayed at the right of the screen, select the **All Settings**  menu icon and press **OK** to access the advanced TV setup menus.
4. Use the arrow navigation keys to select/highlight either the **General** menu icon from the TV setup menus or the **Safety** menu icon from the Function Menu. Then, press the number “7” key a total of seven times to access the TV Manager (see example on following page).

Note: Ez Download is always selected by default when you initially access the TV Manager. Also note that Diagnostics is for service use only.

5. If more than one USB memory device is currently connected to the TV, be sure to select the USB device that contains the software file you wish to use. If necessary, use the arrow keys on the Installer Remote to select/highlight the **USB DEVICE** button in the top right corner of the screen and press **OK**. Then, use the Up/Down arrow keys to select the appropriate USB device from the pop-up list of USB devices displayed at the top of the screen.



(Continued on next page)

Reference: Updating TV/PTC Software using a USB Memory Device (Cont.)

(Continued from previous page)

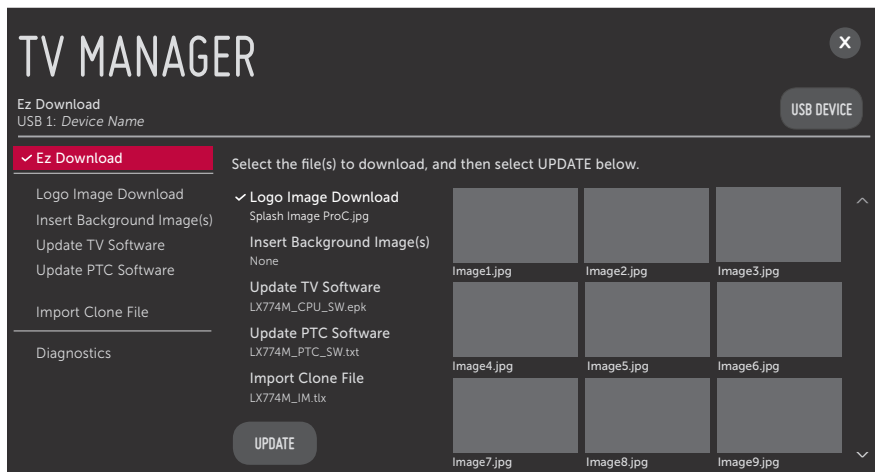

6. Use the Up/Down arrow keys to select **Update TV Software** or **Update PTC Software**, as applicable, and press **OK**.

Depending on your selection, a list of either TV or PTC software files stored in the LG_DTV folder on the USB memory device will be displayed on the screen. Above the listing of files, you can also see the current version of TV or PTC software. The following screen sample illustrates an Update TV Software screen.

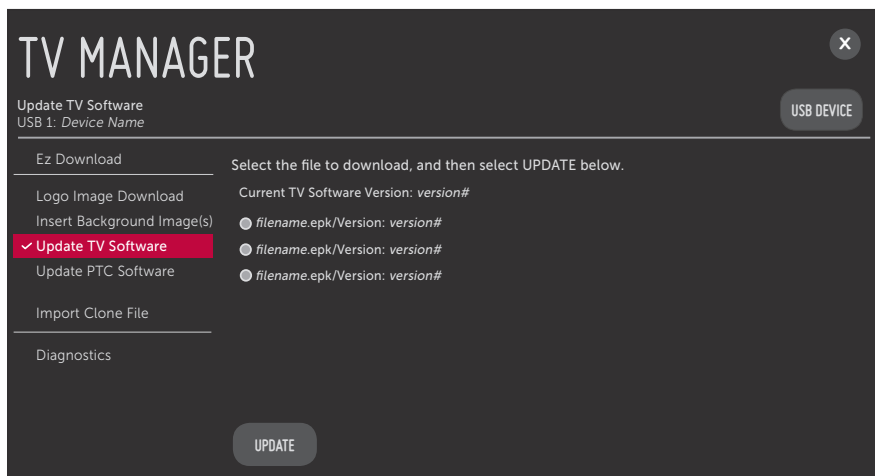

7. Use the arrow keys to select/highlight the update file to download, and then press **OK**.
8. When you are ready to download the update, select **UPDATE** on the screen, and then press **OK** on the Installer Remote.

Software update progress will be displayed on the screen. Do NOT remove the USB device until the software update is complete. When the software update is complete, an UPDATE COMPLETE pop-up banner will briefly be displayed at the bottom of the screen, and then, the TV will reboot.

Reference: Downloading a Splash Screen Image using a USB Memory Device

This section describes how to download a splash screen image using the TV Manager “Logo Image Download” option, though you may also use the Ez Download utility to download the splash screen image, if desired. See “Ez Download Utility” on pages 38 to 41 for further information.

Splash Screen Image File Guidelines

- The splash screen image may be either a baseline or progressive JPEG or a 24-bit (RGB 8x8x8) BMP.
- A JPEG image should be no larger than 6 MB.
- A BMP image should be no larger than 5.93 MB.
- The maximum resolution allowed for the splash screen image is 1920 x 1080 pixels (FHD).
- Avoid using special characters, such as ?, &, @, etc., in the splash screen image filename.

Before You Begin

- The splash screen image file must be stored in a folder named “LG_DTV” in the root directory of the USB memory device.
- Ensure the USB device has been formatted with FAT format.

Download the Splash Screen Image

1. Turn ON the TV, and then insert the USB memory device into either of the USB ports on the TV.
2. Press **MENU** on the Installer Remote to display the TV setup menus (TV is in Pass-through Mode) or the Function Menu (TV is not in Pass-through Mode).
3. (TV in Pass-through Mode only) From the Quick Settings Menu displayed at the right of the screen, select the **All Settings**  menu icon and press **OK** to access the advanced TV setup menus.
4. Use the arrow navigation keys to select/highlight either the **General** menu icon from the TV setup menus or the **Safety** menu icon from the Function Menu. Then, press the number “7” key a total of seven times to access the TV Manager (see example on following page).

Note: Ez Download is always selected by default when you initially access the TV Manager. Also note that Diagnostics is for service use only.

5. If more than one USB memory device is currently connected to the TV, be sure to select the USB device that contains the image file you wish to use. If necessary, use the arrow keys on the Installer Remote to select/highlight the **USB DEVICE** button in the top right corner of the screen and press **OK**. Then, use the Up/Down arrow keys to select the appropriate USB device from the pop-up list of USB devices displayed at the top of the screen.



(Continued on next page)

Reference: Downloading a Splash Screen Image using a USB Memory Device (Cont.)

(Continued from previous page)

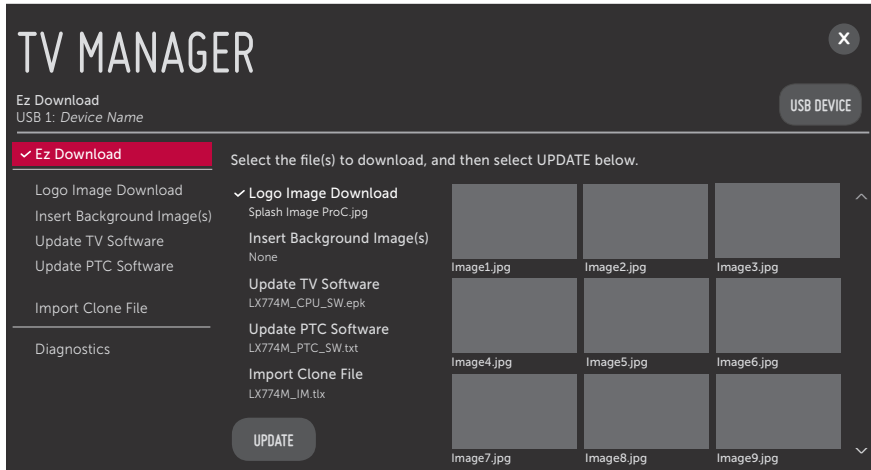

6. Use the Up/Down arrow keys to select **Logo Image Download**, and then press **OK**.

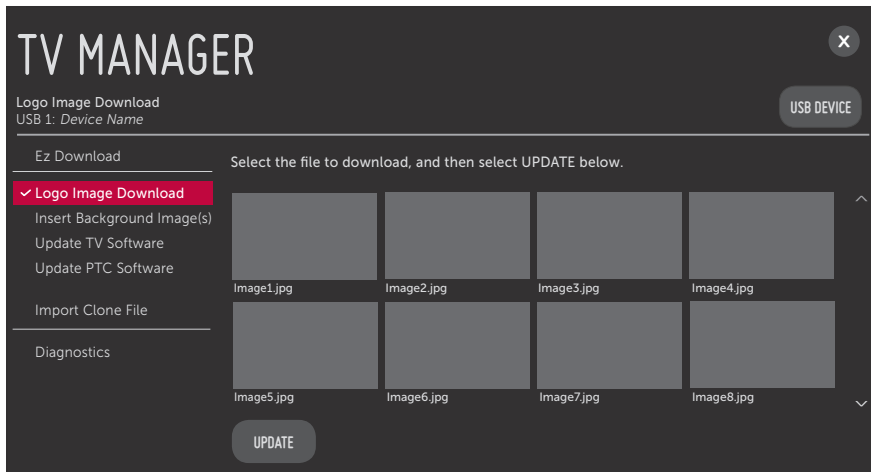

7. Use the arrow keys to select/highlight the image file to download, and then press **OK**.

8. When you are ready to download the image file, select **UPDATE** on the screen, and then press **OK** on the Installer Remote.

Logo image update progress will be displayed on the screen. Do NOT remove the USB device until the splash screen image update is complete. When the image update is complete, a **DOWNLOAD COMPLETE** pop-up banner will briefly be displayed at the bottom of the screen, and then, the TV will reboot. During the reboot, you should see the new splash screen.

Reference: Downloading Background Images using a USB Memory Device

Background images are intended for use with audio-only channels and the Bluetooth Sound Sync feature. Once a mobile device has been paired with the TV, guests may choose to display a slideshow on the screen (as opposed to a blank screen or the Bluetooth Sound Sync screen) while audio is playing.

This section describes how to download background images using the TV Manager “Insert Background Image(s)” option, though you may also use the Ez Download utility to download the background image(s), if desired. See “Ez Download Utility” on pages 38 to 41 for further information.

Background Image File Guidelines

- A background image may be either a baseline or progressive JPEG or a 24-bit (RGB 8x8x8) BMP.
- A JPEG image should be no larger than 6 MB.
- A BMP image should be no larger than 5.93 MB.
- The maximum resolution allowed for a background image is 1920 x 1080 pixels (FHD).
- Avoid using special characters, such as ?, &, @, etc., in a background image filename.

Before You Begin

- The background image file(s) must be stored in a folder named “LG_DTV” in the root directory of the USB memory device.
- Ensure the USB device has been formatted with FAT format.

Download the Background Image(s)

1. Turn ON the TV, and then insert the USB memory device into either of the USB ports on the TV.
2. Press **MENU** on the Installer Remote to display the TV setup menus (TV is in Pass-through Mode) or the Function Menu (TV is not in Pass-through Mode).
3. (TV in Pass-through Mode only) From the Quick Settings Menu displayed at the right of the screen, select the **All Settings**  menu icon and press **OK** to access the advanced TV setup menus.
4. Use the arrow navigation keys to select/highlight either the **General** menu icon from the TV setup menus or the **Safety** menu icon from the Function Menu. Then, press the number “7” key a total of seven times to access the TV Manager (see example on following page).

Note: Ez Download is always selected by default when you initially access the TV Manager. Also note that Diagnostics is for service use only.

5. If more than one USB memory device is currently connected to the TV, be sure to select the USB device that contains the image file you wish to use. If necessary, use the arrow keys on the Installer Remote to select/highlight the **USB DEVICE** button in the top right corner of the screen and press **OK**. Then, use the Up/Down arrow keys to select the appropriate USB device from the pop-up list of USB devices displayed at the top of the screen.



(Continued on next page)

Reference: Downloading Background Images using a USB Memory Device (Cont.)

(Continued from previous page)

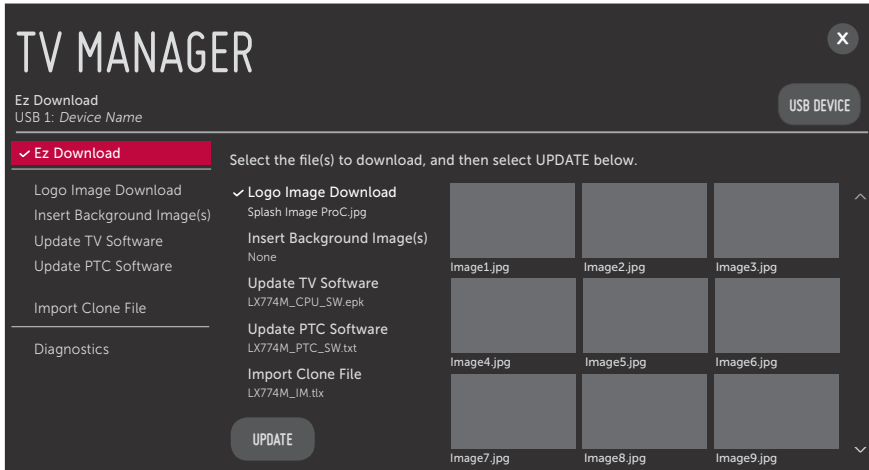

6. Use the Up/Down arrow keys to select **Insert Background Image(s)**, and then press **OK**.

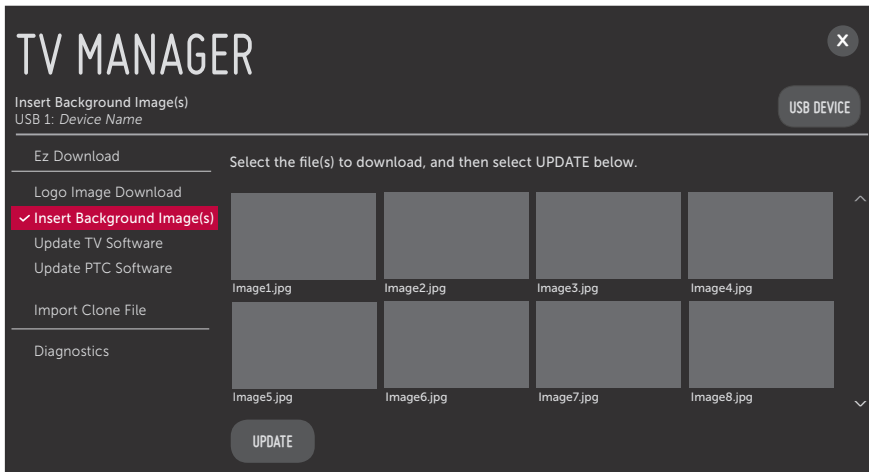

7. Use the arrow keys to select/highlight the image file(s)—up to 12 images or 10 MB—to download, and then press **OK**.

8. When you are ready to download the image file(s), select **UPDATE** on the screen, and then press **OK** on the Installer Remote.

Background image update progress will be displayed on the screen. Do NOT remove the USB device until the background image update is complete. When the image update is complete, a **DOWNLOAD COMPLETE** pop-up banner will briefly be displayed at the bottom of the screen, and then, the TV will reboot.

Reference: Power Consumption Settings

The following tables assume that Installer Menu item 118 POWER SAVINGS is set to 3 (default) and Installer Menu item 099 BACK LIGHTING is set as shown below (default value is 255).

| Item 099 Back Lighting (Static) | 32LX774M | | 43LX774M | | 55LX774M | |
|---------------------------------------|---------------------------|-----------------|---------------------------|-----------------|---------------------------|-----------------|
| | Power Consumption (Watts) | Percent Savings | Power Consumption (Watts) | Percent Savings | Power Consumption (Watts) | Percent Savings |
| 100 | 50.0 | 0% | 63.0 | 0% | 70.0 | 0% |
| 90 | 47.0 | 6% | 60.0 | 5% | 65.0 | 7% |
| 80 | 45.0 | 10% | 56.0 | 11% | 60.0 | 14% |
| 70 | 42.0 | 16% | 51.0 | 19% | 55.0 | 21% |
| 60 | 39.0 | 22% | 48.0 | 24% | 51.0 | 27% |
| 50 | 37.0 | 26% | 44.0 | 30% | 47.0 | 33% |
| 40 | 34.0 | 32% | 39.0 | 38% | 42.0 | 40% |
| 30 | 31.0 | 38% | 35.0 | 44% | 37.0 | 47% |
| 20 | 28.0 | 44% | 31.0 | 51% | 32.0 | 54% |
| 10 | 26.0 | 48% | 27.0 | 57% | 28.0 | 60% |
| 1 | 23.0 | 54% | 23.0 | 63% | 23.0 | 67% |

| Item 099 Back Lighting (Dynamic) | 32LX774M | | 43LX774M | | 55LX774M | |
|--|---------------------------|-----------------|---------------------------|-----------------|---------------------------|-----------------|
| | Power Consumption (Watts) | Percent Savings | Power Consumption (Watts) | Percent Savings | Power Consumption (Watts) | Percent Savings |
| 200 | 50.0 | 0% | 63.0 | 0% | 70.0 | 0% |
| 190 | 47.0 | 6% | 60.0 | 5% | 65.0 | 7% |
| 180 | 45.0 | 10% | 56.0 | 11% | 61.0 | 13% |
| 170 | 42.0 | 16% | 51.0 | 19% | 56.0 | 20% |
| 160 | 39.0 | 22% | 48.0 | 24% | 52.0 | 26% |
| 150 | 37.0 | 26% | 43.0 | 32% | 47.0 | 33% |
| 140 | 34.0 | 32% | 38.0 | 40% | 42.0 | 40% |
| 130 | 31.0 | 38% | 35.0 | 44% | 37.0 | 47% |
| 120 | 28.0 | 44% | 31.0 | 51% | 32.0 | 54% |
| 110 | 26.0 | 48% | 27.0 | 57% | 28.0 | 60% |
| 101 | 23.0 | 54% | 23.0 | 63% | 23.0 | 67% |

Note: Values are results of controlled experiments under laboratory conditions.

Reference: TV Aux Input Configuration

| DIRECT ACCESS Tuning * | | TV | | ENABLE | | | | | MPI DATA | | | | Installer Menu Item 046 START AUX SRCE (Start Aux Source) Value |
|---|---|--------------|---------------|----------------|-----------------|-------|--|-------------------|--|-------|--|---|---|
| | | | | Installer Menu | | | MPI DATA STATUS TYPE 0x41 SOURCES ENABLED (R/W) | | DATA STATUS TYPE 0xD2 CURRENT AV SOURCE (R) | | DATA STATUS TYPE 0x0D AUX SOURCE (R) | | |
| Installer Menu Item 029 OLD OCV = 0 | Installer Menu Item 029 OLD OCV = 1 | Aux Input | Input Mode | Item | Function | Value | Enable Bit | Label | Value | Value | Description | | |
| 131-0 | 91-0 | AV (Rear) | CV | 39 | REAR AUX EN | 1 | 1 | Rear Video (Aux) | 1 | 0 | VIDEO | 1 | |
| 132-0 | 92-0 | HDMI 2 | DTV | 91 | HDMI2 ENABLE | 1 | 2 | S-Video Rear | 2 | 0 | VIDEO | 5 | |
| | | | PC | | | 2 | | | | 2 | COMPUTER | | |
| 133-0 | 93-0 | HDMI 1 | DTV | 35 | HDMI1 ENABLE | 1 | 3 | Front Computer | 3 | 0 | VIDEO | 3 | |
| | | | PC | | | 2 | | | | 2 | COMPUTER | | |

* Use Installer Remote to enter channel number indicated based on OLD OCV Installer Menu setting.

Reference: *b*-LAN Setup & Overview

The *b*-LAN module is internal to the TV. It allows hospital/institution head end equipment with *b*-LAN technology to communicate, via the institution's RF distribution system, with the TV for configuration and control.

Installer Menu item 118 POWER SAVINGS controls the power circuitry for both the embedded *b*-LAN module and the GAME CONTROL/MPI port. The default value is 3—the *b*-LAN module is only powered when the TV is turned ON. See chart below.

| POWER SAVINGS | TV OFF | TV ON |
|---------------|---|---|
| | <i>b</i> -LAN & GAME CONTROL/MPI Port Power | <i>b</i> -LAN & GAME CONTROL/MPI Port Power |
| 1 | On | On |
| 3 (default) | Off | On |

A *b*-LAN enabled head end device, such as an LG FMA-LG102, broadcasts over the RF distribution system to communicate to multiple TVs. When the TV is first installed, it must be turned ON in order for its embedded *b*-LAN module to receive communication from the head end device. At this point, if it is desired for the *b*-LAN module to always be powered, including while the TV is turned OFF, set Installer Menu item 118 POWER SAVINGS to 1.

Also, if MPI communication is required for external MPI control, set Installer Menu item 118 POWER SAVINGS to 1 so that the GAME CONTROL/MPI port circuitry is always powered.

 **Caution: POWER SAVINGS should NEVER be set to 7. This setting is intended for factory use only.**

Reference: FTG Mode via EBL (Local Configuration)

The following steps outline local FTG configuration of individual TV EBLs using a direct PC-to-TV (EBL) connection. Refer to the **Free-To-Guest (FTG) Device Configuration Application User Guide** for further information. FTG Device Configuration Application software is available online at: www.lg.com/us/business/display-solutions/ftg.

Note: If the TV CPU is already in FTG Mode, you cannot use this procedure to make changes to the FTG Channel Map and FTG Installer Menu settings. Refer to FTG Mode information on pages 8 to 10 for further details.

Note: If the preceding condition applies, but you wish to switch the TV to FTG Mode via EBL, see Reference section, “Restoring Factory Defaults on the TV(s),” for further information before proceeding.

1. Install (if necessary) and launch the FTG Device Configuration Application (v5.5.7 or later) on the PC that will be used to configure the EBL.
2. Build an FTG Channel Map using the FTG Channel Map Editor in the FTG Channel Map Configuration Utility (or, if applicable, open an existing FTG Configuration [.rml] file).

Note: Up to 141 logical channels can be defined in the FTG Channel Map.

3. Connect the PC to the TV-LINK CFG jack on the TV’s rear jack panel using a USB-to-TTL serial cable (TTL-232R-5V-AJ). If necessary, install the device driver on the PC.

4. Turn ON the TV.

Note: If Installer Menu item 118 POWER SAVINGS is set to 3 (default), the TV must be ON in order for steps 5 and 6 below to be successful.

5. “Write” the FTG Channel Map to the EBL (switches the EBL from Pass-through Mode to FTG Mode).

Note: After a “Write” of new data, the TV will briefly display a green text banner that shows the EBL firmware version and release date.

6. “Read” the current FTG Installer Menu settings from the EBL using the FTG Installer Menu Configuration Utility. If necessary to make changes to Installer Menu items, “Write” them back to the EBL in FTG Mode.

7. Save the FTG Channel Map and FTG Installer Menu settings to an FTG Configuration (.rml) file for future use.

8. Tune the TV to a logical channel in the FTG Channel Map.

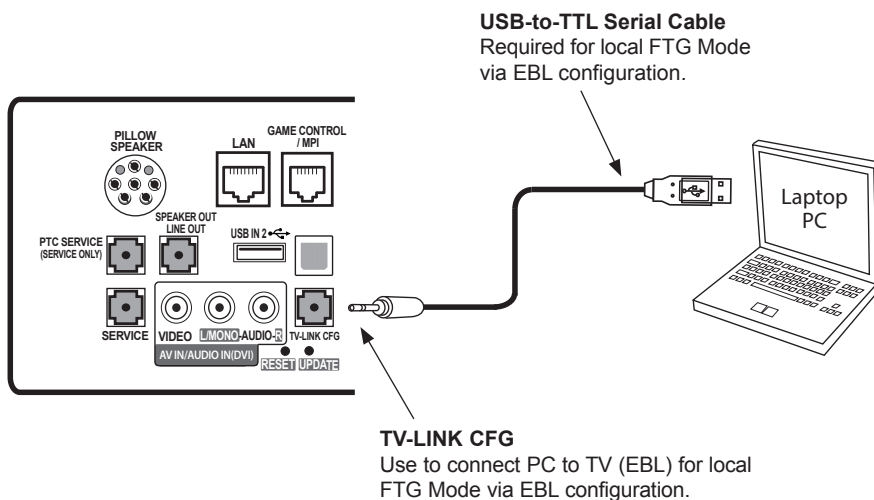

Reference: Auto Input(s) Sensing Feature

This section provides detailed settings information for Installer Menu item 042 AUTO INPUTS. To disable auto-sensing for all available Aux inputs, set item 042 to 0. To enable auto-sensing for all available Aux inputs, set item 042 to 255. For specifications on all other available settings (i.e., settings for individual inputs), refer to the Aux Inputs Values table on the following page.

Note: When both item 042 AUTO INPUTS *and* item 041 SIMPLINK EN are enabled in the Installer Menu, HDMI inputs will be detected by SIMPLINK, but the Auto Input(s) Sensing Feature will not function.

In the Installer Menu, an informational text code is displayed at the right of each Auto Inputs value, for example:

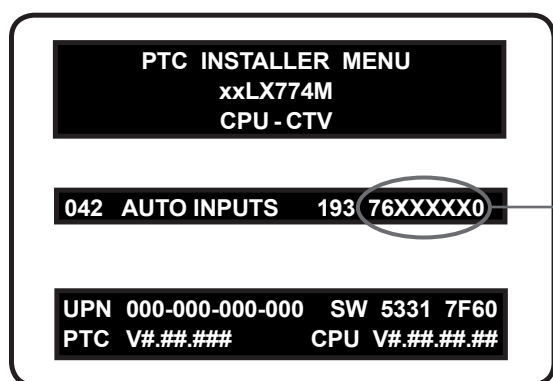

AUTO INPUTS Text Code

This example illustrates Installer Menu item 042 value 193, which enables auto-sensing for all available Aux inputs. The input #s in the text code (7, 6, 0 in this example) identify the enabled Aux inputs. See the Input # Assignments table below for a listing of the LX774M Aux inputs and their corresponding text code input #s. The Auto Inputs Values table on the following page shows the text codes for all item 042 values.

Each Auto Inputs text code consists of eight characters that identify the Aux input(s) for which auto-sensing is enabled. The following table identifies the Installer Menu text code input # for each Aux input that is available on the LX774M TV models. The table also identifies the Installer Menu item associated with each Aux input. Remember that in order for auto-sensing to be enabled for an input, that input must also be enabled in the Installer Menu.

Input # Assignments

| Installer Menu Text Code Input # | Aux Input | Installer Menu | |
|-------------------------------------|--------------|----------------|--------------|
| | | Item | Function |
| 0 | AV | 039 | REAR AUX EN |
| 6 | HDMI 1 | 035 | HDMI1 ENABLE |
| 7 | HDMI 2 | 091 | HDMI2 ENABLE |

Reference: Auto Input(s) Sensing Feature (Cont.)

The following table shows all available Aux inputs as if each is enabled in the Installer Menu. The Installer Menu text codes for item 042 will be altered accordingly if any of the available Aux inputs are disabled in the Installer Menu.

Auto Inputs Values

| Item 042 Value | Aux Inputs | | | Installer Menu Text Code |
|----------------|------------|----------|----------|--------------------------|
| | AV | HDMI 1 | HDMI 2 | |
| 000 | Disabled | Disabled | Disabled | DDXXXXXD |
| 001 | Enabled | Disabled | Disabled | DDXXXXX0 |
| 064 | Disabled | Enabled | Disabled | D6XXXXXD |
| 065 | Enabled | Enabled | Disabled | D6XXXXX0 |
| 128 | Disabled | Disabled | Enabled | 7DXXXXXD |
| 129 | Enabled | Disabled | Enabled | 7DXXXXX0 |
| 192 | Disabled | Enabled | Enabled | 76XXXXXD |
| 193 | Enabled | Enabled | Enabled | 76XXXXX0 |
| 255 | Enabled | Enabled | Enabled | 76XXXXX0 |

X = Aux input is Disabled or Not Available (i.e., on these TV models)

D = Auto-sensing for input is Disabled

Input # = Auto-sensing for input is Enabled

Reference: LX774M Hospital Operations

Hospital Features

The following table identifies when and how the LX774M hospital features are supported in three different TV configurations. As indicated in the introduction to this document, LG commercial TV functionality is based on “ownership” of the Channel Map. For the purposes of this table, “CPU” indicates that the TV is in Pass-through Mode with the Channel Map in the CPU (i.e., auto-tuned/edited channel lineup) and “PTC” indicates that the TV is in Pass-through Mode with the Channel Map in the PTC (PTC-CTV Mode).

| Hospital Mode State | Item | CPU | | PTC | | FTG/PPV Mode | |
|---|------|----------|---------|----------|---------|--------------|---------|
| | | Disabled | Enabled | Disabled | Enabled | Disabled | Enabled |
| Installer Menu | Item | | | | | | |
| IR Banks Enable | 012 | | | | X | | |
| Scan Mode | 013 | | | X | X | X* | X* |
| Start Channel in Scan Mode | 014 | | | X | X | X* | X* |
| Feature Level | 020 | | | | | | |
| Bed 1/Bed 2 | 020 | X | | X | | X | |
| Multi-code IR | 020 | X | X | X | X | X | X |
| Speaker | 020 | X | | X | | X | |
| Function Preview | 025 | | | X | X | | |
| Hospital Mode | 027 | | | | | | |
| Bed 1/Bed 2 | 027 | | X | | X | | X |
| Pillow Speaker Voltage | 027 | (b) | X | (b) | X | (b) | X |
| Speaker | 027 | | X | | X | | X |
| Quick Shutoff | 077 | (c) | (c) | (c) | (c) | (c) | (c) |
| Channel Banks | | | | | | | |
| Number of Banks Enabled | | | | 1 | 4 | 1 | 4* |
| Channel Preview/Banks Setup Menu | | | | X | X | | |
| Blanked Channel | | | | X | X | X | X |
| Inactive TV | | | | | X | | X* |
| SAP Key (special use in Channel Preview/Banks Setup Menu) | | | | | X | | |
| Aux Input Sources | | | | | | | |
| Input List Menu | | X | X | X | | X | |
| Aux in Channel Lineup | | | | X | X | (d) | X*/(d) |
| TV Setup Menus | | | | | | | |
| Sound Out (TV Speaker) | | (e) | (e) | (e) | (e) | (e) | (e) |
| General (Standby Light) | | X | X | X | X | | |

* Applicable for FTG Mode via CPU only.

X = feature supported

a) Turn ON function only. Always goes to channel 2-0.

b) Zenith pillow speaker code/(+12v) supply voltage. (When Installer Menu item 027 is set to 254 [factory default value], there is no power [voltage] supplied to the pillow speaker interface.)

c) Quick Shutoff feature only functions when Scan Mode is enabled and if you are using an analog pillow speaker.

d) Dependent upon installer-defined FTG/PPV Channel Map.

e) Sound Out Menu is only accessible when the speaker selected is TV Only or both TV & Pillow.

Reference: LX774M Hospital Operations (Cont.)

Speaker Selection

The following table outlines speaker settings as determined by Installer Menu items 027 HOSPITAL MODE and 020 FEATURE LEVEL.

| Item 027 HOSPITAL MODE Value | Item 020 FEATURE LEVEL Value | Sound Out Menu | Speaker |
|------------------------------|------------------------------|---------------------|-------------|
| 0 | 0–24 | External Speaker | None |
| 0 | 0–24 | Internal TV Speaker | TV Only |
| 0 | 64–65 | N/A | Pillow Only |
| 1–34 | N/A | N/A | Pillow Only |
| 65–98 | N/A | External Speaker | None |
| 65–98 | N/A | Internal TV Speaker | TV Only |
| 129–162 | N/A | External Speaker | Pillow Only |
| 129–162 | N/A | Internal TV Speaker | Pillow & TV |

Note: The Sound Out Menu is only accessible when the speaker selected is TV Only or both TV & Pillow.

Reference: Restoring Factory Defaults on the TV(s)

This section describes how to restore all factory defaults or just the Installer Menu factory defaults either on a single TV that is currently in Pass-through Mode, FTG Mode, Application Tuning Mode, etc. or on multiple TVs that are currently in FTG Mode.

Restore All Factory Defaults

This section describes how to restore a single TV, regardless of its mode, to a factory default condition. The following procedure requires that you contact LG technical support to obtain a predefined value/password for Installer Menu item 117 FACT DEFAULT that enables access to initiate a factory “IN-STOP” process, which restores all factory defaults. This procedure will also reactivate the LG First Use Wizard.

1. Use the Installer Remote to access the TV’s Installer Menu, navigate to Installer Menu item 117 FACT DEFAULT, and key in the value provided by technical support. Then, press **OK**.
2. At the prompt for confirmation, key in the password provided by technical support. This will initiate the IN-STOP that restores the factory defaults on the TV.

Installer Menu Item 117 FACT DEFAULT

If the TV is currently in Pass-through Mode, you can set Installer Menu item 117 FACT DEFAULT to 1 to restore the Installer Menu factory defaults and clear the PTC Channel Map, including any assigned channel icons and custom text labels. Note, however, that if a complete restoration of the TV’s factory defaults is required, see “Restore All Factory Defaults” above.

Additional FTG Mode via CPU Options

There are two additional options for restoring Pass-through Mode/Installer Menu factory defaults on TVs that are in FTG Mode via the CPU. The first enables you to restore a single TV to Pass-through Mode, while the second enables you to restore multiple TVs to Pass-through Mode at one time. However, both options require that you create a “Zero Mapped Channels” FTG Configuration (.tlx) file, i.e., an FTG Configuration file with no data. Refer to the *Free-To-Guest (FTG) File Manager User Guide* for further information.

- Using a USB memory device, import a “Zero Mapped Channels” FTG Configuration (.tlx) file to the TV. Refer to “Importing a Clone File” on pages 59 to 63 for further information on the import procedure.
- If your system uses a Pro:Centric server for remote management of LX774M TVs that are in FTG Mode, use the Pro:Centric Admin Client to load a “Zero Mapped Channels” FTG Configuration (.tlx) file on the Pro:Centric server. Refer to the *Pro:Centric Server Admin Client User Guide* for further information.

Additional FTG Mode via EBL Options

There are two additional options for restoring Pass-through Mode/factory defaults on TVs that are in FTG Mode via the EBL. The first enables you to restore a single TV to Pass-through Mode, while the second enables you to restore multiple TVs to Pass-through Mode at one time.

 **Note: While the IN-STOP process described above will clear both the PTC and the CPU, both options below only clear the PTC. Thus, the current Channel Map and TV setup menu settings will remain in the CPU after the reset is completed.**

- Using a direct PC-to-TV connection, “Write” an unpopulated Channel Map—that is, a Channel Map with 0 (zero) channels—to the TV. See Reference section, “FTG Mode via EBL (Local Configuration),” and/or the *Free-To-Guest (FTG) Device Configuration Application User Guide* for further information.
- If your system uses an FMA for remote management/broadcast configuration, configure the FMA device with an FMA Configuration (.fma) file that only contains a “0 Mapped Channels” FTG Channel Map to broadcast to the TV EBL(s). Refer to the *Free-To-Guest (FTG) Device Configuration Application User Guide* and/or the Installation & Configuration Guide for the FMA device for further information.

Reference: Using the TV's Zoning Features

This section describes the TV Zoning and Wi-Fi Zoning features available with the LX774M model TVs. These features are primarily intended for use when the TV is configured for FTG Mode via CPU operation; however, Wi-Fi Zoning, along with selected elements of TV Zoning (Installer Menu and Setup Menu profile Zone assignments), may also be used with TV cloning processes using a USB memory device / “.tlx” file. Refer to the appropriate section(s) below for further information on the Zoning features and how to set the TV or Wi-Fi Zone # in a TV that is currently in Pass-through Mode.

TV Zoning Feature

The TV Zoning feature enables you to create localized configurations for TVs in selected locations, or “Zones,” within the installation environment, for example, a lobby area, fitness center, restaurant, etc.

Using the TV Zoning Feature with FTG Mode via CPU Configuration

The FTG File Manager may be used to create an FTG Configuration (.tlx) file that contains multiple Installer Menu and Setup Menu profiles, each with its own Zone assignment. Up to nine unique Zones can be designated for LX774M FTG Installer Menu and/or Setup Menu profiles. Zone restrictions can also be placed on individual channels in the FTG Channel Map. Thus, for example, you may create an FTG Installer Menu and/or Setup Menu profile to specifically configure a TV in the fitness center and also restrict the channels that are available to be tuned on that TV.

The TV Zone # must be set appropriately on each TV in order for the TVs to be configured correctly. See “Set the TV Zone # and/or Wi-Fi Zone # in the TV” on page 96, and set the TV Zone # in all the TVs in a select area, so that the TVs are configured with corresponding FTG Installer Menu and/or Setup Menu settings and/or can omit channels that have been restricted in the FTG Channel Map. TV Zone 0 is the default TV Zone #.

The following subsections briefly describe how to assign Zone designations in the FTG File Manager. Refer to the **Free-To-Guest (FTG) File Manager User Guide** for further information.

FTG Installer Menu Profile Zone Assignments

The FTG File Manager main screen enables you to change the Zone assignment (default = Zone 0) for each Installer Menu profile to be included in an FTG Configuration (.tlx) file. For example, you may wish to create one LX774M Installer Menu profile for the lobby area and another LX774M Installer Menu profile for the fitness center, both of which are different from the Installer Menu profile used for standard patient rooms. The TV Zoning feature enables you to save multiple LX774M FTG Installer Menu profiles, each with its own Zone assignment, in one FTG Configuration file. If each TV in the aforementioned locations (Zones) has had its TV Zone # set appropriately, as described in the procedure on page 96 or via the EZ-Manager Wizard, the TV(s) will only be configured by the Installer Menu profile that matches its(their) Zone setting.

In the FTG File Manager main screen, you can also edit the Zone assignment for each Installer Menu profile and/or Setup Menu profile already present in the FTG Configuration List and Setup Menu List windows.

Note: See also the FTG File Manager main screen overview on page 66. In addition, note that Setup Menu profiles cannot be created in the FTG File Manager; they must be saved (exported) from a TV.

FTG Channel Map Zone Restrictions

The FTG Channel Map Editor in the FTG File Manager's FTG Channel Map Configuration Utility enables you to place Zone restrictions on individual channels that may be prohibited or deemed unsuitable for certain locations. In the FTG Channel Map Editor, one or more Zone restrictions (1–8) may be placed on each channel that is to be restricted. For example, if you wish to restrict a channel from Zones 2 and 4, select both “Zone 2” and “Zone 4” in the Zone Restriction section of the FTG Channel Map Editor screen when defining or editing that channel.

Reference: Using the TV's Zoning Features (Cont.)

Note: While a channel can be restricted from up to eight Zones, a TV can only ever be in (set for) one Zone. See also the FTG Channel Map Editor overview on page 68.

At the same time, keep in mind that the TV Zone designations are not mutually exclusive. That is, you may opt to place Zone restrictions on selected channels in the FTG Channel Map, but at the same time, you can choose to configure all TVs at the site with the same Installer Menu and/or Setup Menu settings. For example, an FTG Configuration (.tlx) file being used to configure the TVs at a site may contain multiple Installer Menu and Setup Menu profiles with different Zone assignments, as well as an FTG Channel Map with Zone restrictions on several channels. Each TV that still has the default TV Zone 0 setting will *only* be configured by the Installer Menu and/or Setup Menu profile(s) with a Zone 0 designation. If, on the other hand, the TV Zone # is set to 1, the TV will first look in the file for the LX774M Installer Menu and/or Setup Menu profile(s) with a Zone 1 designation. If none of the LX774M Installer Menu and/or Setup Menu profiles has a Zone 1 designation, the TV will then look for the LX774M profile(s) with a Zone 0 designation. For the FTG Channel Map configuration, when the TV Zone # is set to 0, the TV will ignore any Zone restrictions (1–8) that may be placed on channels in the FTG Channel Map. However, when the TV Zone # is set to 1, the TV will omit any channels that have been restricted from Zone 1 in the FTG Channel Map.

Using the TV Zoning Feature with Cloning Configuration

A location-specific configuration / Clone (.tlx) file may be saved (exported) from a Master TV and then be used to configure Target TVs. For example, if the TV Zone # in the Master TV is set to 3 before the Clone file export is initiated, the Master TV's Installer Menu and Setup Menu profiles will be saved with the TV Zone 3 assignment. In order to configure the Target TVs with the Zone 3 Installer Menu and Setup Menu profiles exported from the Master TV, you must set the TV Zone # accordingly in the Target TVs before importing the Clone file. See "Set the TV Zone # and/or Wi-Fi Zone # in the TV" on the following page. Also, see "Cloning Procedures" on pages 57 to 63 for additional information on the cloning processes. TV Zone 0 is the default TV Zone #.

Wi-Fi Zoning Feature

The Wi-Fi Zoning feature enables you to use a Clone/Configuration (.tlx) file to configure an individual TV or group of TVs with a particular Wi-Fi access point's login data to create "Wi-Fi Zones" within the installation environment.

Using the Wi-Fi Zoning Feature with FTG Mode via CPU Configuration

The FTG File Manager may be used to create an FTG Configuration (.tlx) file with an FTG Installer Menu profile that contains login data for multiple Wi-Fi access points, each assigned a Wi-Fi Zone #. Up to 100 Wi-Fi Zones can be designated within each FTG Installer Menu profile, thus allowing for distribution of the Wi-Fi network load. For example, if a site has 50 LX774M TVs within close proximity, you may wish to create 10 Wi-Fi Zones, each with its own access point that has unique login data, so that no more than five of the TVs are connected to one access point at any given time.

In order for a TV to be configured by the proper Installer Menu profile with the desired Wi-Fi access point login data for wireless networking (i.e., SSID, security type, and security key), you must set both the TV Zone # and the Wi-Fi Zone # in the TV (see "Set the TV Zone # and/or Wi-Fi Zone # in the TV" on the following page for further information). If the Wi-Fi Zone # in the TV is set to 0 (default), the TV will not obtain access point login data from the Installer Menu profile with which it is configured unless the profile contains the global Wi-Fi Zone 100. Any TV that does not find its matching Wi-Fi Zone # in the FTG Configuration file, but does find the global Wi-Fi Zone 100, will be configured with the global access point login data.

Refer to the ***Free-To-Guest (FTG) File Manager User Guide*** for further information on defining Wi-Fi Zones in the FTG File Manager.

Reference: Using the TV's Zoning Features (Cont.)

Using the Wi-Fi Zoning Feature with Cloning Configuration

A location-specific Wi-Fi configuration / Clone (.tlx) file may be saved (exported) from a Master TV and then be used to configure Target TVs. First, the wireless network (i.e., the access point login data) must be configured in the Master TV's IP Environment Menu (see "Configuring a Wi-Fi Network Connection" on page 72). Then, a Wi-Fi Zone # must be set in the Master TV (see "Set the TV Zone # and/or Wi-Fi Zone # in the TV" below). If desired, a TV Zone # may also be set in the Master TV.

For example, if the Wi-Fi Zone # is set to 4 and the TV Zone # is set to 5 before the Clone file export is initiated, the Master TV's Installer Menu profile will be saved with the Zone 5 assignment, and within that Installer Menu profile, the access point login data for wireless networking (i.e., SSID, security type, and security key) will be saved with a Wi-Fi Zone 4 assignment. In order to configure the Target TVs with the proper Installer Menu profile and access point login data, you must set both the TV Zone # and the Wi-Fi Zone # in the Target TVs accordingly before importing the Clone file. See "Set the TV Zone # and/or Wi-Fi Zone # in the TV" below. Also, see "Cloning Procedures" on pages 57 to 63 for additional information on the cloning processes. If the Wi-Fi Zone # in the TV is set to 0 (default), the TV will not obtain access point login data from the Installer Menu profile with which it is configured unless the profile contains the global Wi-Fi Zone 100. Any TV that does not find its matching Wi-Fi Zone # in the Clone file, but does find the global Wi-Fi Zone 100, will be configured with the global access point login data.

Set the TV Zone # and/or Wi-Fi Zone # in the TV

You can set the TV Zone # and/or the Wi-Fi Zone # in the EZ-Manager Wizard (see "EZ-Manager Wizard" on pages 19 to 27) or, if the TV is in Pass-through Mode, via the TV's setup menus as described below. Note that the following procedure can only be performed while the TV is in Pass-through Mode. You will also be able to specify a Label (North, South, East, West) and Room Number for this TV, if desired.

1. Turn ON the TV.
2. Press **MENU** on the Installer Remote, and use the arrow navigation keys to select/highlight the **General** menu icon. Then, press **OK**.
3. In the General Menu, use the Up/Down arrow keys to select **Room Info**, and then press **OK**.
4. In the Room Info screen, complete the appropriate fields as described below. Use the Up/Down arrow keys on the Installer Remote to navigate between each of the fields.
 - **Wi-Fi Zone:** Enables you to set a Wi-Fi Zone # so that the TV can be configured with a particular access point's login data for wireless networking. Login data (i.e., SSID, security type, and security key) may be provided in a Clone/Configuration (.tlx) file.
To assign a Wi-Fi Zone, select/highlight the **Wi-Fi Zone** field and press **OK**. Then, use the Left/Right arrow keys to specify the desired Wi-Fi Zone # (1–99). Press **OK** when you are finished.
 - **TV Zone:** Enables you to set a TV Zone # so that the TV can be configured with Installer Menu and/or Setup Menu settings intended only for the assigned Zone. The Installer Menu and/or Setup Menu settings may be provided in a Clone/Configuration (.tlx) file. If the TV is being configured for FTG Mode via CPU, the TV Zone # setting also allows the TV to omit channels that have been restricted in the FTG Channel Map (see "FTG Channel Map Zone Restrictions" on page 94).
To change the TV Zone, select/highlight the **TV Zone** field and press **OK**. Then, use the Left/Right arrow keys to specify the desired TV Zone # (0–8). Press **OK** when you are finished.

(Continued on next page)

Reference: Using the TV's Zoning Features (Cont.)

(Continued from previous page)

- **Label:** Allows you to select a North, South, East, or West text label for this TV. Select/highlight the **Label** field and press **OK**. Then, use the Up/Down arrow keys to select the applicable label. Press **OK** when you are finished.
- **Room Number:** Allows you to specify the number of the room in which the TV is located. To enter a room number, use the Up/Down arrow keys to select/highlight the **Room Number** field and press **OK**. You can then use the number keys on the Installer Remote to directly enter a room number, or you can use the arrow keys to select the appropriate alphanumeric character(s) from the pop-up virtual keyboard at the bottom of the screen. When you are done, select **Enter** from the virtual keyboard, and then press **OK** on the Installer Remote.

Note: The TV name (default: TV's serial number) will be changed to the room number specified here. See "Media Share Setup" on pages 76 to 77 for further information on the TV name.

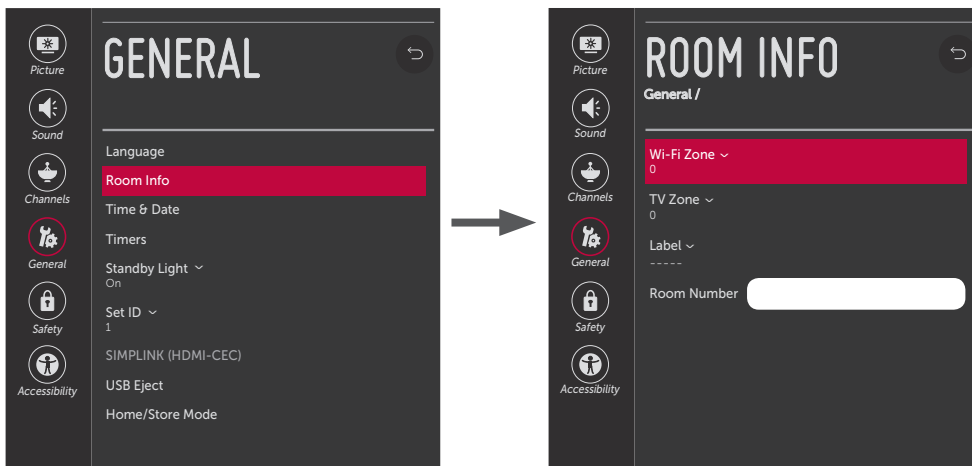

5. When you have completed the fields as necessary, press **↵** to return to and/or exit the TV menus, or press **MENU** to return to program viewing.

Reference: Using Media Share Features

When the appropriate Media Share options are enabled in the IP Environment / Media Share Menu (see “Media Share Setup” on pages 76 to 77, as necessary), guests have the ability to use one or more of the following Media Share features:

- **Smart Share:** Allows guests to use the TV to access and view media files (photos, videos, music, etc.) shared either by wired DLNA Certified devices (the devices must be connected to the same LAN as the TV) or by wireless LG devices using LG’s Smart Share application with Wi-Fi Direct.
- **Screen Share:** Allows guests to select a Miracast or WiDi capable device, whose screen can be displayed on the TV.
- **Bluetooth Sound Sync:** Allows guests to listen to audio from a Bluetooth-enabled mobile device through the TV’s speakers.
- **DIAL:** Allows guests to play selected application media on the TV from a device with DIAL capability. The device may be used to cast any application for which a TV-compatible application has been created/selected for inclusion in the Pre-loaded Apps Menu (see “Pre-loaded Applications” on page 78).
- **SoftAP:** Allows guests to use the TV as a 2.4 GHz wireless access point for up to five devices.

This section provides an overview of the Smart Share, Screen Share, Bluetooth Sound Sync, DIAL, and SoftAP functionality.

 **Note: Typically, only one Media Share feature may be used at a time. If one feature is currently in use, you may have to exit or turn it OFF in order to use/turn ON another. In some cases, you will be prompted to confirm your action. Follow the display prompts as necessary.**

Smart Share

Refer to the subsections below for information on using the Smart Share features.

Smart Share with DLNA Certified Devices

The following steps describe how to access and use the Smart Share feature with wired DLNA Certified devices on the same LAN as the TV.

1. Turn ON the TV, and then use one of the following methods to access media files/folders, depending on the current configuration of the TV:
 - If the Pro:Centric application is not loaded, press **PORTAL** on the Installer Remote, and use the Left/Right arrow keys to select **Music** or **Photo & Video** from the TV’s Smart Launcher.
 - If the Pro:Centric application is loaded, press **MENU** on the Installer Remote to display the Function Menu, use the Up/Down arrow keys to select/highlight the **General** menu icon, and then press **OK**. In the General Menu, use the Up/Down arrow keys to select **Music** or **Photo & Video**.

Note: Depending on the remote control being used (in any mode), you may also access the Smart Launcher via the SMART button.
2. In the next screen (Music or Photo & Video, depending on your selection in the previous step), select the desired Smart Share device, and then select the desired file(s) to view.

Reference: Using Media Share Features (Cont.)

Smart Share with Wi-Fi Direct

The following steps describe how to access and use Wi-Fi Direct (i.e., to connect to a wireless LG device). Remember that you must also turn ON Wi-Fi Direct and launch the Smart Share application on the LG device.

Note: Screen Share MUST be enabled in the Media Share Menu in addition to Smart Share in order for guests to use Wi-Fi Direct (see “Media Share Setup” on pages 76 to 77).

1. Turn ON the TV, and press **MENU** on the Installer Remote to display the TV menus (either the setup menus or the Function Menu depending on whether the TV is or is not in Pass-through Mode).
2. Use the Up/Down arrow keys to select/highlight the **General** menu icon, and then press **OK**.
3. In the General Menu, use the Up/Down arrow keys to select **Wi-Fi Direct**, and then press **OK**.



Note: The example at left shows the General Menu when the TV is in Pass-through Mode. The Wi-Fi Direct screen is the same whether the TV is or is not in Pass-through Mode.

Note: If Wi-Fi Direct is currently grayed out, you may need to exit/turn OFF another Media Share feature in order to use Wi-Fi Direct. For example, make sure that SoftAP is turned OFF. See also note on previous page regarding simultaneous use of Media Share features.

4. When you access the Wi-Fi Direct screen, the TV will automatically initiate a search for all available Wi-Fi Direct enabled wireless devices, including mobile devices, laptops, etc. Devices found will be listed in the lower half of the screen.

Note: If the search does not initially locate any devices, you can select **REFRESH LIST** and press **OK** to rescan.

5. Use the Up/Down arrow keys to select/highlight the device with which you wish to share, and then press **OK**.

The share request will be sent to the targeted device. The user of that device may choose to allow or not allow the share connection. Similarly, other devices may request share connections with this TV (pop-up share requests typically appear in the bottom of the TV screen).

(Continued on next page)

Reference: Using Media Share Features (Cont.)

(Continued from previous page)

6. Use one of the following methods to access media files/folders, depending on the current configuration of the TV:
 - If the Pro:Centric application is not loaded, press **PORTAL** on the Installer Remote, and use the Left/Right arrow keys to select **Music** or **Photo & Video** from the TV's Smart Launcher.
 - If the Pro:Centric application is loaded, use the Up/Down arrow keys to select **Music** or **Photo & Video** from the General Menu.

Note: Depending on the remote control being used (in any mode), you may also access the Smart Launcher via the SMART button.
7. In the next screen (Music or Photo & Video, depending on your selection in the previous step), select the desired Smart Share device, and then select the desired file(s) to view.

Screen Share (Miracast / WiDi)

The following steps describe how to access and use the Miracast / WiDi features.

1. Turn ON the TV, and then use one of the following methods to access the Screen Share application, depending on the current configuration of the TV:
 - If the Pro:Centric application is not loaded, press **PORTAL** on the Installer Remote, and use the Left/Right arrow keys to select **Screen Share** from the TV's Smart Launcher.
 - If the Pro:Centric application is loaded, press **MENU** on the Installer Remote to display the Function Menu, use the Up/Down arrow keys to select/highlight the **General** menu icon, and then press **OK**. In the General Menu, use the Up/Down arrow keys to select **Screen Share**.

Note: Depending on the remote control being used (in any mode), you may also access the Smart Launcher via the SMART button.

Note: If Screen Share is currently not available in the Smart Launcher or in the General Menu (the latter applicable to FTG Mode only), you may need to turn OFF another Media Share feature in order to use Screen Share. For example, access the General Menu and make sure that SoftAP is turned OFF. See also note on page 98 regarding simultaneous use of Media Share features.
2. Follow the on-screen instructions to initiate the Miracast / WiDi connection from your Miracast / WiDi device. Note that you may be prompted to enter a PIN number that appears on the TV screen into your Miracast / WiDi connection window to complete the connection.

Once the connection is established, the TV display may be used as a second screen for the Miracast / WiDi device.

Bluetooth Sound Sync

The following steps describe how to access and use the Bluetooth Sound Sync feature.

Note: Bluetooth Sound Sync is only accessible from the TV's Smart Launcher. If the TV is not in Pass-through Mode, you will need a remote with a SMART button in order to display the Smart Launcher.

1. Turn ON the TV, and then use one of the following methods to display the TV's Smart Launcher, depending on the current configuration of the TV:

(Continued on next page)

Reference: Using Media Share Features (Cont.)

(Continued from previous page)

- If the Pro:Centric application is not loaded, press **PORTAL** on the Installer Remote.
 - If the Pro:Centric application is loaded, press **SMART** on the Installer Remote (see note above regarding remote with SMART button).
2. Use the Left/Right arrow keys on the Installer Remote to select **Bluetooth Sound Sync**, and then press **OK**.
 3. Follow the on-screen instructions to initiate and confirm pairing between your device and the TV.

Once Bluetooth pairing is successful, audio from the device may be heard through the TV's speakers. (Make sure the TV volume is at the appropriate level.)

DIAL

The following steps describe how to access and use DIAL. Remember that the device used **MUST** be connected to the same network as the TV.

Note: DIAL may only be used with device applications for which a TV-compatible application (for example, YouTube) has been created/selected for inclusion in the Pre-loaded Apps Menu (see "Pre-loaded Applications" on page 78).

Note: The applications that may be used in conjunction with DIAL are only accessible from the TV's Smart Launcher. If the TV is not in Pass-through Mode, you will need a remote with a SMART button in order to display the Smart Launcher.

1. Turn ON the TV, and then use one of the following methods to display the TV's Smart Launcher, depending on the current configuration of the TV:
 - If the Pro:Centric application is not loaded, press **PORTAL** on the Installer Remote.
 - If the Pro:Centric application is loaded, press **SMART** on the Installer Remote (see note above regarding remote with SMART button).
2. Use the Left/Right arrow keys on the Installer Remote to select the desired application, and then press **OK**.
3. On your device, launch the same application, and use the appropriate options (typically available via Settings) to initiate a connection/pairing with the TV. You may also need to access the Settings options from the application on the TV to complete the pairing operation. Follow the on-screen instructions.

Once the connection/pairing is successful, you will be able to view media from the application on the TV.

SoftAP

The following steps describe how to access and use the SoftAP feature.

Note: This procedure describes how to access SoftAP from the TV's General Menu. It is also possible to access SoftAP using the Wi-Fi Service option available from the TV's Smart Launcher (via the PORTAL button on the remote control if the Pro:Centric application is not loaded or, depending on the remote control being used [in any mode], via the SMART button).

1. Turn ON the TV, and then press **MENU** on the Installer Remote to display the TV menus (either the setup menus or the Function Menu depending on whether the TV is or is not in Pass-through Mode).

(Continued on next page)

Reference: Using Media Share Features (Cont.)

(Continued from previous page)

2. Use the Up/Down arrow keys to select/highlight the **General** menu icon, and then press **OK**.
3. In the General Menu, use the Up/Down arrow keys to select **SoftAP**, and then press **OK**.

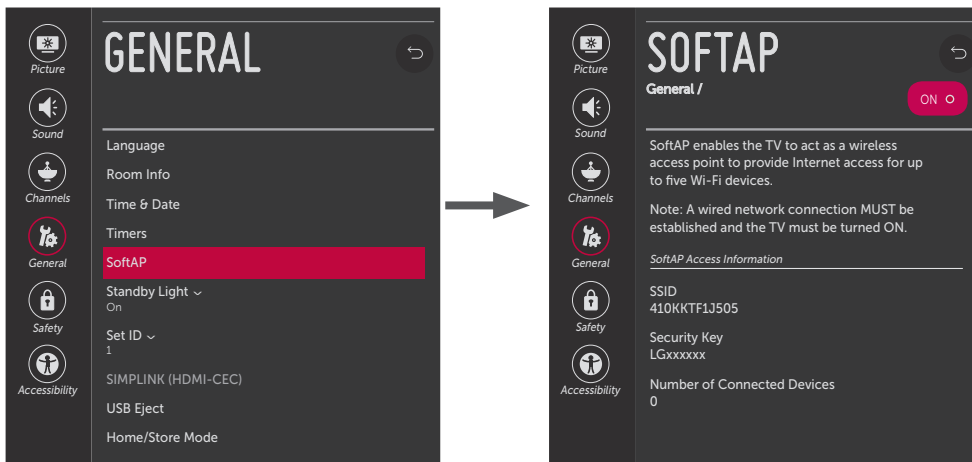

Note: The example at left shows the General Menu when the TV is in Pass-through Mode. The SoftAP screen is the same whether the TV is or is not in Pass-through Mode.

Note: If SoftAP is currently grayed out, make sure a wired LAN connection has been established.

4. When you initially access the SoftAP screen, the OFF/ON toggle button at the top right of the screen is selected/highlighted by default. If SoftAP is currently OFF, press **OK** on the Installer Remote to turn SoftAP ON. When SoftAP is ON, the SoftAP access information, including the SSID and security key, is displayed in the lower half of the screen.
5. Make sure Wi-Fi is turned ON on your device, and then look for the TV's SSID in the list of available Wi-Fi networks. Initiate the connection, and enter the security key as requested.

Once a device is connected successfully to the TV's network, you can use it to access the Internet. Up to five devices may be connected at a time; the Number of Connected Devices field in the SoftAP screen shows the number of devices currently connected to the TV Wi-Fi access point.

Note: A wired network connection **MUST** be established in order for guests to use SoftAP/Wi-Fi Service. Also, the SoftAP/Wi-Fi Service feature may only be used while the TV is turned ON.

Note: If the Wi-Fi frequency is not automatically detected, set the frequency in the device(s) to 2.4 GHz.

Reference: LX774M Rear and Side Jack Panels

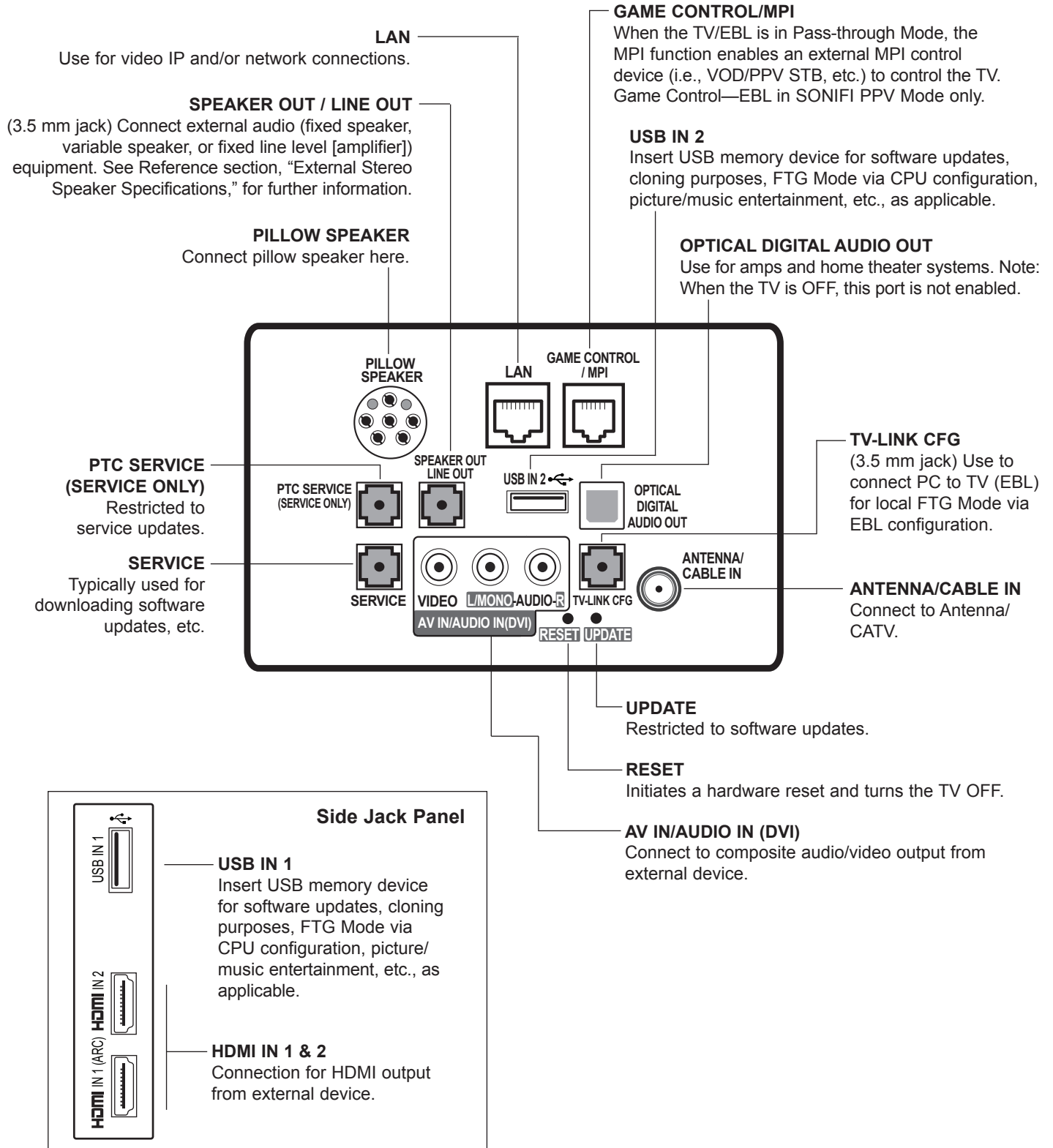

Reference: External Stereo Speaker Specifications

The SPEAKER OUT / LINE OUT 3.5 mm stereo jack on the LX774M rear panel provides stereo speaker signal outputs (fixed speaker, variable speaker, or fixed line level [amplifier]) for external audio equipment. Set Installer Menu item 097 AUDIO OUTPUT as required in accordance with external audio equipment connected to the TV. Also, refer to the following diagram for pinout details.

 **Caution: Do NOT insert a mono plug, as this may damage the TV.**

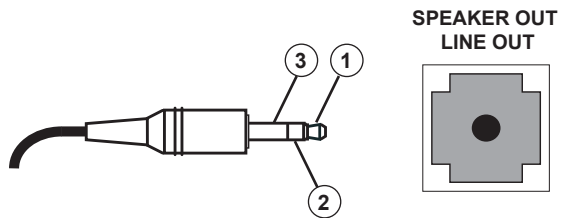

-
- | | |
|---|-----------------|
| 1 | LEFT (Tip) |
| 2 | RIGHT (Ring) |
| 3 | GROUND (Sleeve) |
-

Reference: Installer Remote Control Typical Key Functions

An LG Installer Remote is required to set up and operate the TV. The LG Installer Remote illustrated below shows typical remote control functions and is provided for reference only.

TV LG1/TV LG2 & TV Z1/TV Z2
Selects the LG or Zenith IR codes sent by the remote. In order for the TV to respond, this setting must match the setting in the TV.

Numbers (0 - 9) & DASH
Use to enter a channel or program number. Dash is used for sub-channel numbers such as 9-1, 9-2, etc.

FLASHBK (Flashback)
Returns to the previously tuned channel.

CHANNEL UP/DOWN
Changes channels based on channels in the channel lineup.

VOLUME UP/DOWN
Increases/decreases sound level.

Arrows (Up/Down/Left/Right) & OK
Use to navigate on-screen menus, direct tune channels, and adjust TV settings.

CH. BANK
Selects Channel Bank 1, 2, 3, or 4 when Hospital Mode is enabled and the TV is in PTC-CTV Mode or FTG Mode via CPU. Otherwise, this button displays available Aux inputs.

CH. PREVIEW
Displays and exits the Channel Preview/Banks Setup Menu (TV in PTC-CTV mode only).

MUTE
Switches sound On or Off.

TIMER
Sets the amount of time before the TV automatically turns itself Off.

ALARM
Enables users to schedule a one-time "alarm" event, in which the TV turns itself On at the user-specified time.

EXIT
Clears all on-screen displays and returns to program viewing.

POWER
Turns the TV On or Off.

MENU
Displays and removes the TV setup menus (or, if applicable, the Function Menu).

PORTAL
Displays and removes the Pro:Centric interactive menu.

INFO
Displays channel information.

GUIDE
Displays and removes the Pro:Centric channel guide/EPG.

↵ (RETURN)
Returns one level to the previous menu/display.

Color buttons access special functions in some menus.

CC
Activates subtitles, unless the Channel Preview/Banks Setup Menu is currently on the screen (applicable for PTC-CTV Mode only), in which case this option displays the Lock (V-Chip) Menu.

SAP
Analog Mode: Selects MTS sound (Mono, Stereo, or SAP). DTV Mode: Changes the audio program language, if additional languages are available. *

* SAP notes:

- If SAP is selected and no SAP is provided, sound may not be heard on channel.
- Each channel may have its own SAP setting.
- Each time digital channels are tuned, the TV attempts to locate the default audio program language. If the default audio program language is not available, the TV will use the first available audio program.

Reference: LG Pro:Centric Patient Remote and Pillow Speaker

LG Pro:Centric patient remotes and/or pillow speakers are available for purchase (see patient remote example at right and pillow speaker example on following page). For additional information and/or to purchase an LG Pro:Centric patient remote or pillow speaker, please contact your LG service representative.

Patient Remote and Pillow Speaker Functionality

Both the LG Pro:Centric patient remote and the LG Pro:Centric pillow speaker provide access to Pro:Centric application features (via PORTAL, INFO, and GUIDE buttons). See also “Installer Remote Control Typical Key Functions” on the previous page for further information on button functions. The patient remote also provides multi-code capability as described below.

Set the Patient Remote IR Code Scheme (Multi-code Feature)

This section describes how to set the LG Pro:Centric patient remote to send unique IR codes based on “bed number” in a multi-TV single room installation. The remote may be set from Bed 1 to Bed 4.

Note: The TV will always respond to the standard LG Installer Remote IR code scheme, i.e., you can always use an Installer Remote with the TV, regardless of its multi-code IR setting.

The following procedure describes how to set the bed number in the TV’s Installer Menu and in the patient remote.

1. Installer Menu item 020 FEATURE LEVEL determines the additional IR code scheme to which the TV will respond. Access the Installer Menu, and set item 020 to the desired value (16–19).

The patient remote must now be set to match the FEATURE LEVEL setting. That is, if item 020 is set to 17 for Bed 2, the patient remote must also be set to multi-code Bed 2.

Note: By default, the patient remote IR code scheme is the same as the standard LG Installer Remote IR code scheme.

2. On the patient remote, press and hold **OK** along with the desired (bed) number key (1–4).
The LED at the top left of the remote will light for three seconds and then turn OFF.
3. Once the LED turns OFF, release both keys on the remote.
4. Verify that the patient remote now controls the TV, based on your settings.

Note: If necessary, you can restore the patient remote IR code scheme to the standard LG Installer Remote IR code scheme by pressing and holding **OK** on the remote along with the “0” key.



**Typical LG
Pro:Centric Patient
Remote**

Reference: LG Pro:Centric Patient Remote and Pillow Speaker (Cont.)

USB Media Navigation

This section provides a brief overview of the LG Pro:Centric patient remote and LG Pro:Centric pillow speaker navigation tools for use with USB media files (photos, videos, music, etc.).

Note: The LG Pro:Centric pillow speaker is currently the only pillow speaker that enables users to navigate and play/view USB media files.

Note: Refer to the Owner's Manual for detailed information on USB memory device requirements and the types of media supported by the LX774M TVs.

1. Insert the USB memory device into either of the TV's USB ports.

Once the TV detects the USB device, a SmartShare icon will be displayed on the screen. Press **OK** (patient remote) or **Enter** (pillow speaker) to access the Smart Share application.

2. Use the arrow keys on the patient remote /pillow speaker to select/highlight the desired option(s) in the Smart Share screen, and then press **Enter/OK**.
3. Within each USB media directory (Photos, Videos, or Music):
 - Use the arrow keys on the patient remote/pillow speaker to navigate from one folder or file to another, and press **Enter/OK** to open or play a selected folder or file.
 - Use the arrow keys on the patient remote/pillow speaker, as necessary, to scroll through all available files.
 - In View and Play modes, you typically can use the pillow speaker/patient remote to navigate to another directory level (without exiting the Smart Share application).
 - To exit the Smart Share application, press **↵** (patient remote) or **Return** (pillow speaker). The TV's Smart Launcher will be displayed along the bottom of the screen, and you can use the Left/Right arrow keys on the patient remote/pillow speaker to select **LiveTV** to return to program viewing. If you wish to relaunch the Smart Share application, you must physically remove and then reinsert the USB memory device.

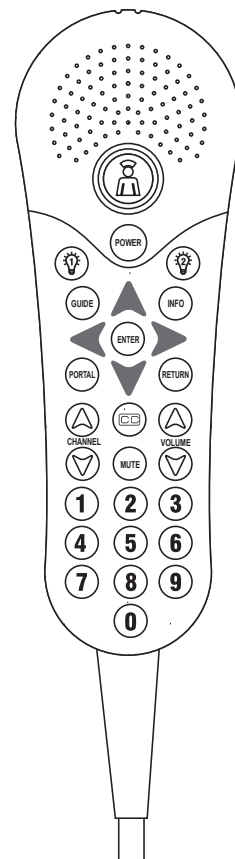

Typical LG
Pro:Centric Pillow
Speaker

Reference: Pillow Speaker Setup

The pillow speaker will only be functional after the Express Script/Custom Master TV Setup and/or cloning/USB configuration procedures are complete.

Note: When Installer Menu item 027 HOSPITAL MODE is set to 254 (factory default value), there is no power (voltage) supplied to the pillow speaker interface.

Connecting a Pillow Speaker to the TV

Connect the pillow speaker (see example at right) to the PILLOW SPEAKER interface on the rear jack panel of the TV.

 **Caution:** Use a pillow speaker that is a UL recognized pendant control bearing the warning: “Risk of fire if used in oxygen enriched atmosphere. Keep pendant control away from oxygen equipment.”

Controlling the TV with Serial Data

These TV models are capable of being controlled by a single-wire, serial data signal. This is an LG patented technology and is being implemented by certain brands of “smart” pillow speakers.

Pillow Speaker Interface

This connector provides an interface for patient-pendant remote control or entertainment audio and nurse call systems. All lines are isolated from the AC power line and earth ground (a transformer isolates the DC supply, optocouplers isolate the control lines, and a transformer isolates the audio). For positive voltage configurations (e.g., for Zenith/Philips pillow speakers), +12 volts/+5 volts is provided on pin 3 (Channel Up/Data In) in reference to pin 4 (Common). For negative voltage configurations (e.g., for RCA pillow speakers), +5 volts is provided on pin 4 in reference to pin 3.

The following table describes the pillow speaker interface pinout (see also diagram at right).

| Pin No. | Description |
|---------|--|
| 1 | Analog external control for TV ON/OFF. |
| 2 | No connection |
| 3 | Analog external control for Channel Up or Serial Data In. |
| 4 | Common connection for control, data, and audio output. |
| 5 | Isolated Audio Output. Nominal 14 ohm source impedance with short circuit protection. Audio level control provided by an external low-impedance, pad-type volume control or serial data Volume Up/Down keys. |
| 6 | Analog external control for Channel Down. |

Controlling the TV with Mechanical Switches

A typical analog pillow speaker with mechanical switches will momentarily connect pin 1, 3, or 6 to pin 4 (Common) to control Power ON/OFF, Channel Up, or Channel Down (see schematic at right). These pins are at +13 volts DC (when measured from pin 4) with the switches open. Typical current draw is 8 mA when a switch is closed. (This operation is identical to previous models using the 5-wire interface, except that only +7 volts DC was supplied and current draw was only 2.5 mA.)

Typical Pillow Speaker (Serial Data Control)

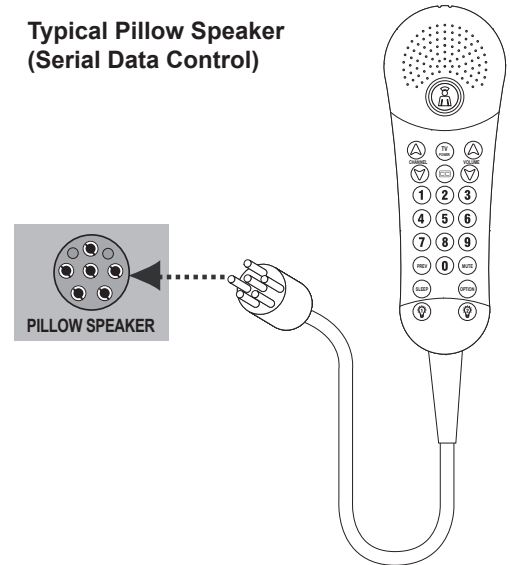

Pillow Speaker Interface Pinout

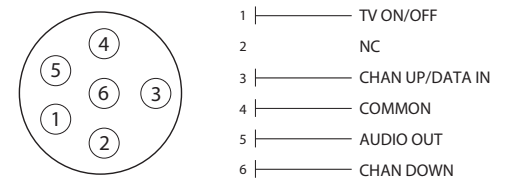

Typical Schematic for Analog Pillow Speaker

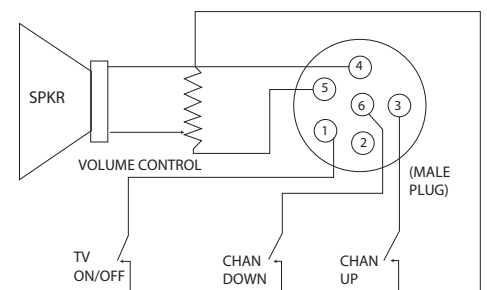

General Guidelines: Choosing a Location for Installing a VESA Standard Mount

To the right are some examples of VESA standard mounts. Since there are numerous types of stands and mounts available, only a few are shown here. Refer to the instructions provided with the TV stand that will be used to mount the TV. Be sure the style of stand selected is capable of supporting the weight of the TV and is appropriate for the application.

Wall Mounts

If the mount will be on a wall, a typical wooden stud behind the wall board would be the preferred choice for a location to attach the wall mount. The wall mount location chosen should be appropriate for drilling holes and have available the required power source as well as antenna/cable and any other equipment leads as necessary.

Pedestal Mounts and Stands

A sturdy surface on a desk or other similar flat table-like furniture would be the appropriate location for mounting a pedestal-style TV stand.

Most stands are designed so that the wiring is threaded through the stand itself or a loop-through style clamp so that the wiring is neatly bunched and not strung in such a way as to create a potential hazard to the user. (Some stands are portable and can be moved from one location to another.) Be sure all safety considerations are followed.

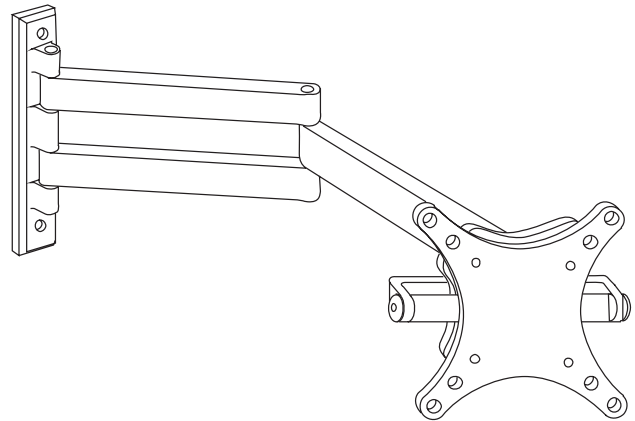

Typical Wall Stud Type Mount with Swivel Bracket

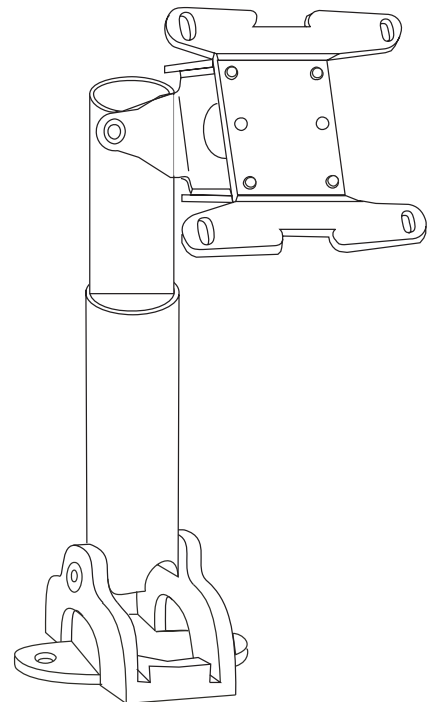

Typical Pedestal Type Mount with Swivel Bracket

Troubleshooting

General Troubleshooting (Some Quick and Easy Tips for Resolving Problems)

Installation

| Symptom | Possible Cause(s) | Possible Solution(s) |
|---|---|--|
| Cannot direct enter channel number. | (TV in Pass-through Mode) Installer Menu item 028 CH. OVERRIDE is set to 0, i.e., disabled (recommended setting). | If Installer Menu item 028 CH. OVERRIDE is set to 0, only channels that are active in the TV's channel lineup can be selected. Set CH. OVERRIDE to 1 to allow access for direct keypad entry to all channels. |
| | (TV not in Pass-through Mode) The channel entered is not included in the applicable Channel Map. | Channel access is restricted to channels included in the applicable Channel Map, for example the FTG Channel Map if the TV is in FTG Mode or the Pro:Centric Direct Channel Map if the TV is in Application Tuning Mode with Pro:Centric Direct. If necessary, make changes to the Channel Map using the appropriate application/content editor. |
| No channels present after Express Script. | Auto Tuning not run. | Refer to Express Script procedure. Auto Tuning must be run in order for the channel lineup to be populated. To reactivate the Express Script, restore the TV to a factory default condition. |

Picture Reception and Sound

| Symptom | Possible Cause(s) | Possible Solution(s) |
|-----------------------------------|--|--|
| No picture. | TV is turned OFF. | <ul style="list-style-type: none"> • Turn TV ON. • Power failure? |
| | Antenna/cable not connected. | Connect antenna/cable signal to TV. |
| | Connections incorrect. | Check connections on TV. |
| | MPI not connected. | If applicable, connect MPI cable to MPI device. |
| | Encrypted program. | Try another channel. |
| | Wrong tuning band. | Adjust Installer Menu settings. |
| Normal picture, poor or no sound. | Audio muted. | Press MUTE or use Volume Up key to increase sound level. |
| | Broadcast problem. | Try a different channel. |
| | Pillow/TV speaker not configured properly. | Check that Installer Menu items 020 FEATURE LEVEL and 027 HOSPITAL MODE are set as required. Also, if applicable, select TV Speaker in the Audio Menu. |

Erratic Operation

| Symptom | Possible Cause(s) | Possible Solution(s) |
|-----------------------|--------------------------------|---|
| Installer Menu setup. | Wrong Installer Menu settings. | Adjust Installer Menu settings as required. |

Installer Remote

| Symptom | Possible Cause(s) | Possible Solution(s) |
|--|---|--|
| Remote doesn't work. | Remote not in TV Mode. | Depending on the remote used, you may need to use a MODE key to put the remote into TV Mode. |
| | Not aimed at IR receiver. | Point remote at IR receiver on TV. |
| | Remote too far from IR receiver or IR path is obstructed. | Move remote closer to IR receiver on TV, darken room, and/or remove obstructions. |
| | MPI not connected. | If applicable, connect MPI cable to MPI device. |
| | Weak batteries. | Replace batteries. |
| | Wrong battery polarity. | Check that "+" and "-" match in battery compartment. |
| | Too much light in room. | Dim room light. |
| Remote IR codes do not match setting(s) in TV. | Make sure the Installer Remote is compatible. Contact your LG representative, as necessary. Then, check settings both in the TV and on the remote. IR codes sent by the remote must match the setting(s) in the TV. | |

Commercial Mode Check / FTG Operation Troubleshooting

Commercial Mode Check

Use this flowchart to determine whether the TV is currently in Commercial Mode.

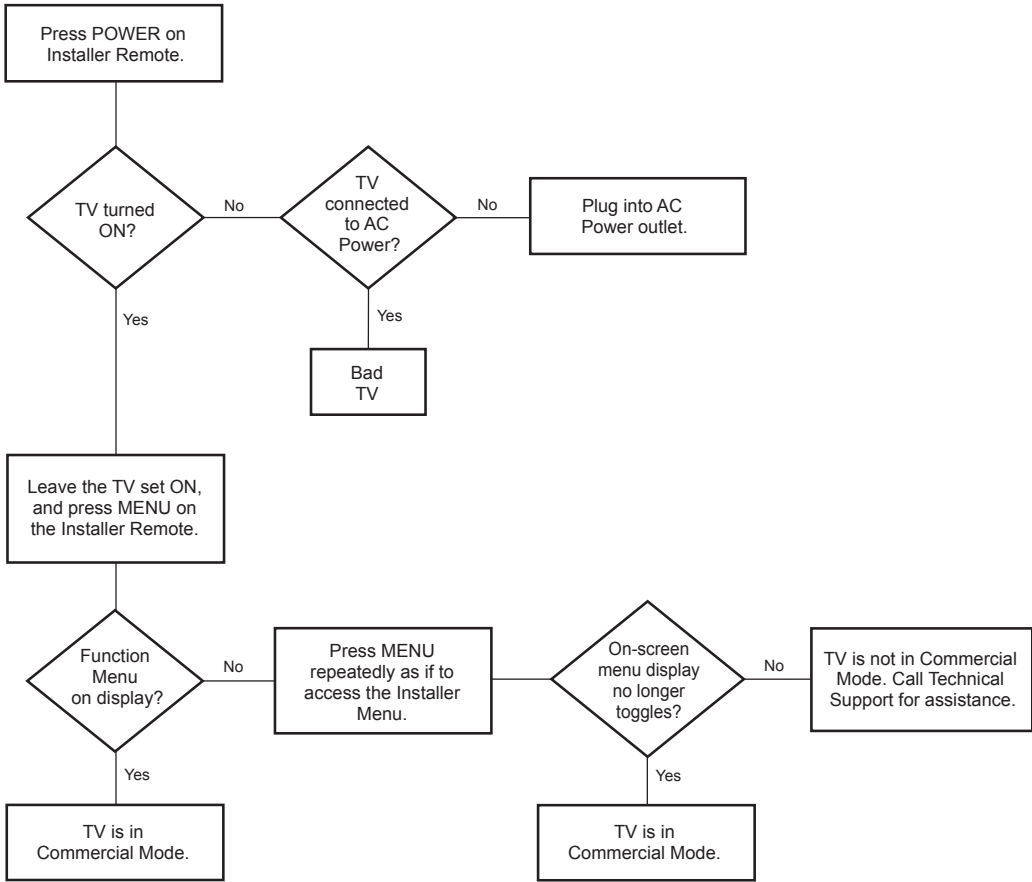

FTG Operation Troubleshooting

The following table provides troubleshooting information for when the EBL is configured for FTG Mode operation.

| Symptom | Possible Cause(s) | Solution(s) |
|--|---------------------------------|--|
| Communication Error ("Communications Timeout") | Cable(s) not connected. | Check and connect communication cables. |
| | TV not powered. | Check/connect the TV power cord. |
| | TV not turned ON. | TV needs to be turned ON (default setting of Installer Menu item 118 POWER SAVINGS). |
| | Wrong COM (communication) port. | In the FTG Device Configuration Application, select the correct COM port for the cable being used. |

Troubleshooting (Cont.)

Channel Banks Setup Troubleshooting

| Symptom | Possible Cause | Possible Solution |
|---|--|---|
| Channel is blanked in all channel banks. | Blanking a channel in one channel bank will make it blank in all channel banks. | Modify the channel attribute(s), if desired, using the FTG Channel Map Editor in the FTG File Manager. See also "FTG Channel Map Editor" overview on page 68. Restore normal operation by unchecking the "Blank Video" checkbox for the channel. Note that normal operation will be restored to the channel in all channel banks. |
| "Inactive TV" message appears and then TV turns OFF. | TV is set up to display "Inactive TV" message if all channels are deleted from Channel Bank 4. | Use the Installer Remote to select another channel bank (1, 2, or 3) to return TV to normal operation. |
| Channel found during Auto Tuning does not tune in with Channel Up/Down. | Channel was deleted in currently selected channel bank. | Premium channels may only be available on another channel bank. Modify the channel bank allocation(s) for the channel, if desired, using the FTG Channel Map Editor in the FTG File Manager. See also "FTG Channel Map Editor" overview on page 68. |
| When CH. BANK key on Installer Remote is pressed, TV shows Input List Menu. | Installer Menu item 027 HOSPITAL MODE is set to 0 (i.e., Hospital Mode is disabled). | Installer item 027 must be set appropriately (i.e., Hospital Mode must be enabled) in order for channel banks to be available. If the TV is in CPU-CTV or PTC-CTV Mode, access the Installer Menu and set item 027 as applicable. If the TV is in FTG Mode via CPU, use the FTG File Manager to update Installer Menu item #027. |

Application Tuning Mode

LG commercial TV mode that enables the TV's Channel Map to reside in a Pro:Centric application.

b-LAN

SONIFI Solutions, Inc. proprietary RF communication system used to configure/control TV via RF distribution system.

Channel Lineup

Channels set in the TV memory, via Auto Tuning/manual editing.

Channel Map

Typically refers to a logical channel mapping of physical channels (for example, an FTG Channel Map). This allows digital channels, like analog channels, to be tuned without requiring the dash key. Also, channels (analog or digital) can be arranged in any order that seems logical for customer tuning/viewing.

Cloning

The process of capturing a Master TV Setup and transferring it to a Target TV using a USB memory device.

Commercial Mode

A mode of operation that provides a broad range of commercial TV features based on control (settings) provided by the PTC and/or an MPI control device.

CPU

The TV's Central Processing Unit. Responsible for the presentation of video and audio from content received via the TV's tuner or Aux inputs.

EBL

Embedded *b*-LAN module. See also *b*-LAN.

E-Z Installation

Enables splash screen image, TV configuration, and software/firmware file downloads to selected TV models from a Pro:Centric server. Managed and administered via the appropriate Pro:Centric Admin Client.

EZ-Manager Wizard

Lodging model TV configuration wizard that provides configuration options for Pro:Centric operation as well as an option for using a USB memory device to configure a TV.

FTG Mode

LG commercial TV mode that enables decryption of Pro:Idiom encrypted channels and logical channel mapping. Implementation and TV operation is based on the "owner" of the FTG Channel Map—the CPU or the EBL. TVs may be configured locally using LG's proprietary PC software or remotely using an applicable head end device.

Function Menu

Available via Installer Remote "MENU" key. Indicates the TV is not in Pass-through Mode. Restricts menu options to a subset of the TV setup menus, allowing users to retain functional control, while disabling setup options.

Installer Menu

Defines commercial TV functionality based on the parameters set.

LG Free-To-Guest (FTG)

Refers to a particular commercial mode of operation within an LG TV. See also FTG Mode.

Logical Channel Number

A number assigned to either a physical or virtual channel number in a Logical Channel Map.

Major Channel Number

Typically, the RF channel number assigned to a digital video stream.

Master TV

A TV whose Channel Map and Installer Menu and TV setup menu settings have been configured as a Master TV Setup for cloning purposes.

Minor Channel Number

A sub-channel or program number assigned to the content embedded in the digital video stream.

MPI

Multiple Protocol Interface. An MPI port or, for some TV models, an MPI card slot provides external control options for solution providers.

Pass-through Mode

The TV's factory default mode of operation. TVs can be configured for stand-alone use or as Master TVs for cloning purposes, and/or TVs may be controlled externally in this mode.

Physical Channel Number

The major channel number assigned to represent a specific 6 MHz RF band as specified by either the broadcast or CATV channel plan. See CEA (formerly EIA) or NCTA specifications for further information.

Pro:Centric Application

LG content delivery and communication interface powered by Pro:Centric server, that provides interactive entertainment, weather, amenities, etc. information for end users. Two application options are available: Pro:Centric Java application or Pro:Centric Direct HTML application.

Pro:Centric Admin Client

Web editor/content wizard provided for service provider and customer configuration of Pro:Centric application and management elements. The proper Admin Client must be used in accordance with licensed (Java or HTML) application.

Pro:Idiom

Zenith proprietary security software that unlocks access to premium content to help assure rapid, broad deployment of HDTV and other high-value digital content.

PTC

Protocol Translation Controller. The commercial controller (microprocessor) of the commercial TV.

Target TV

A TV to which a Master TV Setup will be transferred.

TV Setup Menus

Available via Installer Remote "MENU" key in Pass-through Mode only. Menus provide access to TV setup and functional features.

USB Memory Device

A USB flash drive or USB storage device, etc. that can be used for TV configuration purposes (typically cloning or FTG Mode via CPU configuration) or for updating TV software.

Virtual Channel Number

An alias (virtual) channel number provided in the data stream, by the broadcaster, of a digital broadcast channel to be displayed by consumer TVs in place of the physical channel number. The major number is the same as the original analog channel number and the minor number is the nth program available in that digital video stream.

Document Revision History / Open Source Software Notice

Document Revision History

| Date | Description |
|---------------|---|
| February 2017 | Revision A: New document |
| June 2017 | Revision B: Media Share/Pre-loaded Applications updates |
| August 2017 | Revision C: Pro:Centric Direct and Media Share updates |

Product documentation is available online at: www.lg.com/us/business.

Open Source Software Notice

To obtain the source code under GPL, LGPL, MPL and other open source licenses, that is contained in this product, please visit <http://opensource.lge.com>. In addition to the source code, all referenced license terms, warranty disclaimers and copyright notices are available for download. LG Electronics will also provide open source code to you on CD-ROM for a charge covering the cost of performing such distribution (such as the cost of media, shipping and handling) upon e-mail request to opensource@lge.com. This offer is valid for three (3) years from the date on which you purchased the product.



For Customer Support/Service, please call:

1-888-865-3026

www.lg.com/us/business

Pro:Idiom is a registered trademark of Zenith Electronics LLC. Pro:Centric, Smart Share, and the "LG" logo are registered trademarks of LG Electronics Inc. b-LAN is a trademark of SONIFI Solutions, Inc. DLNA Certified is a registered trademark of Digital Living Network Alliance. Intel is a registered trademark of Intel Corporation in the U.S. and/or other countries. Wi-Fi Direct and Miracast are registered trademarks of Wi-Fi Alliance. All other trademarks or registered trademarks are the property of their respective owners.