



DVD RECORDER OWNER'S MANUAL

MODEL: DR1F9H

Before connecting, operating or adjusting this product,
please read this instruction booklet carefully and completely.



**super
multi**

RW
COMPATIBLE



The Clear Choice In Digital Video™



CAUTION: TO REDUCE THE RISK OF ELECTRIC SHOCK DO NOT REMOVE COVER (OR BACK) NO USER-SERVICEABLE PARTS INSIDE REFER SERVICING TO QUALIFIED SERVICE PERSONNEL.



This lightning flash with arrowhead symbol within an equilateral triangle is intended to alert the user to the presence of uninsulated dangerous voltage within the product's enclosure that may be of sufficient magnitude to constitute a risk of electric shock to persons.



The exclamation point within an equilateral triangle is intended to alert the user to the presence of important operating and maintenance (servicing) instructions in the literature accompanying the product.

WARNING: TO PREVENT FIRE OR ELECTRIC SHOCK HAZARD, DO NOT EXPOSE THIS PRODUCT TO RAIN OR MOISTURE.

CAUTION:

Do not block any ventilation openings. Install in accordance with the manufacturer's instructions.

Slots and openings in the cabinet are provided for ventilation and to ensure reliable operation of the product and to protect it from over heating.

The openings should be never be blocked by placing the product on a bed, sofa, rug or other similar surface. This product should not be placed in a built-in installation such as a bookcase or rack unless proper ventilation is provided or the manufacturer's instruction have been adhered to.

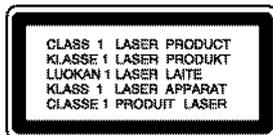

CAUTION:

CLASS 2M VISIBLE AND INVISIBLE LASER RADIATION WHEN OPEN AND INTERLOCKS DEFEATED DO NOT STARE INTO THE BEAM OR VIEW DIRECTLY WITH OPTICAL INSTRUMENTS.

CAUTION:

This product employs a Laser System. To ensure proper use of this product, please read this owner's manual carefully and retain it for future reference. Should the unit require maintenance, contact an authorized service center.

Performing controls, adjustments, or carrying out procedures other than those specified herein may result in hazardous radiation exposure.

To prevent direct exposure to laser beam, do not try to open the enclosure. Visible laser radiation when open. **DO NOT STARE INTO BEAM.**

CAUTION: The apparatus should not be exposed to water (dripping or splashing) and no objects filled with liquids, such as vases, should be placed on the apparatus.

CAUTION concerning the Power Cord

Most appliances recommend they be placed upon a dedicated circuit;

That is, a single outlet circuit which powers only that appliance and has no additional outlets or branch circuits. Check the specification page of this owner's manual to be certain.

Do not overload wall outlets. Overloaded wall outlets, loose or damaged wall outlets, extension cords, frayed power cords, or damaged or cracked wire insulation are dangerous. Any of these conditions could result in electric shock or fire. Periodically examine the cord of your appliance, and if its appearance indicates damage or deterioration, unplug it, discontinue use of the appliance, and have the cord replaced with an exact replacement part by an authorized servicer.

Protect the power cord from physical or mechanical abuse, such as being twisted, kinked, pinched, closed in a door, or walked upon. Pay particular attention to plugs, wall outlets, and the point where the cord exits the appliance.

To disconnect power from the mains, pull out the mains cord plug. When installing the product, ensure that the plug is easily accessible.

FCC WARNING: This equipment may generate or use radio frequency energy. Changes or modifications to this equipment may cause harmful interference unless the modifications are expressly approved in the instruction manual. The user could lose the authority to operate this equipment if an unauthorized change or modification is made.

REGULATORY INFORMATION: FCC Part 15

This equipment has been tested and found to comply with the limits for a Class B digital device, pursuant to Part 15 of the FCC Rules. These limits are designed to provide reasonable protection against harmful interference when the product is operated in a residential installation. This product generates, uses, and can radiate radio frequency energy and, if not installed and used in accordance with the instruction manual, may cause harmful interference to radio communications. However, there is no guarantee that interference will not occur in a particular installation. If this product does cause harmful interference to radio or television reception, which can be determined by turning the product off and on, the user is encouraged to try to correct the interference by one or more of the following measures:

- Reorient or relocate the receiving antenna.
- Increase the separation between the product and receiver.
- Connect the product into an outlet on a circuit different from that to which the receiver is connected.
- Consult the dealer or an experienced radio/TV technician for help.

FCC COMPLIANCE: The responsible party for this product's compliance is:

LG Electronics U.S.A., Inc., 1000 Sylvan Avenue, Englewood Cliffs, NJ.

Phone: 1-201-816-2000.

IMPORTANT SAFETY INSTRUCTIONS

CAUTION: PLEASE READ AND OBSERVE ALL WARNINGS AND INSTRUCTIONS IN THIS OWNER'S MANUAL, AND THOSE MARKED ON THE PRODUCT. RETAIN THIS BOOKLET FOR FUTURE REFERENCE.

This product has been designed and manufactured to assure personal safety. Improper use can result in electric shock or fire hazard. The safeguards incorporated in this product will protect you if you observe the following procedures for installation, use, and servicing.

This product does not contain any parts that can be repaired by the user.

DO NOT REMOVE THE CABINET COVER, OR YOU MAY BE EXPOSED TO DANGEROUS VOLTAGE. REFER SERVICING TO QUALIFIED SERVICE PERSONNEL ONLY.

1. **Read these instructions.** - All these safety and operating instructions should be read before the product is operated.
2. **Keep these instructions.** - The safety, operating and use instructions should be retained for future reference.
3. **Heed all warnings.** - All warnings on the product and in the operating instructions should be adhered to.
4. **Follow all instructions.** - All operating and use instructions should be followed.
5. **Do not use this product near water.** - For example: near a bath tub, wash bowl, kitchen sink, laundry tub, in a wet basement; or near a swimming pool; and other areas located near water.
6. **Clean only with dry cloth.** - Unplug this product from the wall outlet before cleaning. Do not use liquid cleaners.
7. **Do not block any ventilation openings. Install in accordance with the manufacturer's instructions.** - Slots and openings in the cabinet are provided for ventilation and to ensure reliable operation of the product and to protect it from over-heating. The openings should never be blocked by placing the product on a bed, sofa, rug or other similar surface. This product should not be placed in a built-in installation such as a bookcase or rack unless proper ventilation is provided or the manufacturer's instructions have been adhered to.
8. **Do not install near any heat sources such as radiators, heat registers, stoves, or other apparatus (including amplifiers) that produce heat.**
9. **Do not defeat the safety purpose of the polarized or grounding-type plug.** A polarized plug has two blades with one wider than the other. A grounding type plug has two blades and a third grounding prong. The wide blade or the third prong are provided for your safety. If the provided plug does not fit into your outlet, consult an electrician for replacement of the obsolete outlet.
10. **Protect the power cord from being walked on or pinched particularly at plugs, convenience receptacles, and the point where they exit from the product.**
11. **Only use attachments/accessories specified by the manufacturer.**



12. **Use only with the cart, stand, tripod, bracket, or table specified by the manufacturer, or sold with apparatus. When a cart is used, use caution when moving the cart/product combination to avoid injury from tip-over.**
13. **Unplug this product during lightning storms or when unused for long periods of time.**
14. **Refer all servicing to qualified service personnel. Servicing is required when the product has been damaged in any way, such as power-supply cord or plug is damaged, liquid has been spilled or objects have fallen into the product, the product has been exposed to rain or moisture, does not operate normally, or has been dropped.**

Contents

Introduction	5-10
Symbol Used in this Manual	5
Notes on Discs	5
Recordable and Playable Discs	6
Playable Discs	7
Regional Code	7
Card useable on this unit	8
Front Panel	9
Remote Control	10
Remote Control Operation	10
Hookup and Settings	11-24
Rear Panel	11
Connecting an Antenna or Cable TV	12
Connections to Your TV	13
HDMI connection	14
Connecting to an Amplifier	15
Accessory Audio/Video (A/V) Connections	16
Auto Set Up	17
Using the Home Menu	17
Initial Settings	18
General Operation	18
General Settings	18-19
Tuning Band Select	18
Auto Channel Set	18
To Add or Erase Channels	18
Auto Clock Set	19
Manual Clock Set	19
TV Aspect	19
Power Save Mode	19
Factory Set	19
Language Settings	20
Audio Settings	20
Dolby Digital / DTS / MPEG	20
Sampling Frequency	20
DRC (Dynamic Range Control)	20
Vocal	20
Lock (Parental Control) Settings	21-22
Rating	21
Set Password / Area Code	21
Recording Settings	22
Disc Record Mode	22
DV Recording Audio	22
Auto Chapter	22
Disc Settings	22-23
Initialize	22
Finalize	23
Disc Label / Disc Protect	23
PBC / Auto Play	23
DivX Registration Code	23
General Explanation of On-Screen Display	24

Playback	25-32
General Playback Features	25-28
Playing a DivX Movie File	29
Playing an Audio CD or MP3/WMA file	30
Viewing a JPEG File	31-32
Recording	33-38
About DVD recording	33-34
Basic Recording from a TV	35
Instant Timer Recording	35
Playing while you are recording	35
Timer Recording	36
Checking Timer Recording Details	37
Recording from an External Input	37
Recording from DV Input	38
Editing	39-45
Title List and Chapter List Menu Overview	39
VR Mode: Original and Playlist Editing	40
Adding Chapter Markers	40
Changing Title Thumbnails	40
Making a New Playlist	41
Adding Additional Title/Chapters to the Playlist	41
Deleting an Original or Playlist Title/Chapter	42
Deleting a Part	42
Naming a Title	43
Time Search	43
Divide One Titles Into Two	44
Combining Two Chapters Into One	44
Moving a Playlist Chapter	45
Hide a Chapter/Title	45
Protect a Title	45
Reference	46-51
Additional Information	46
Overwriting Recording	46
Viewing Title List menu displayed on other DVD Recorders or Players	46
Playing Your Recordings on Other DVD Players (Finalizing a Disc)	46
Language Codes	47
Area Codes	47
Controlling Your TV with the Supplied Universal Remote Control	48
Troubleshooting	49-50
Specifications	51

Introduction

To ensure proper use of this product, please read this owner's manual carefully and retain for future reference.

This manual provides information on the operation and maintenance of your recorder. Should the unit require service, contact an authorized service location.

About the Symbol Display

"  " may appear on your TV display during operation and indicates that the function explained in this owner's manual is not available on that specific media.

Symbol Used in this Manual

Note:

Indicates special notes and operating features.

Tip:

Indicates tips and hints for making the task easier.

A section whose title has one of the following symbols are applicable only to the disc represented by the symbol.

DVD ALL All DVD discs listed below.

RAM DVD-RAM disc

-RW_{VR} DVD-RW with VR recording mode

-RW_{Video} DVD-RW with Video recording mode

+RW DVD+RW disc

-R DVD-R disc

+R DVD+R (DL) disc

DVD DVD-Video disc

VCD Video CDs

ACD Audio CDs

DivX DivX files

MP3 MP3 files

WMA WMA files

JPEG JPEG files

Notes on Discs

Handling Discs

Do not touch the playback side of the disc. Hold the disc by the edges so that fingerprints do not get on the surface. Never stick paper or tape on the disc.



Storing Discs

After playing, store the disc in its case. Do not expose the disc to direct sunlight or sources of heat and never leave it in a parked car exposed to direct sunlight.

Cleaning Discs

Fingerprints and dust on the disc can cause poor picture quality and sound distortion. Before playing, clean the disc with a clean cloth. Wipe the disc from the center out.

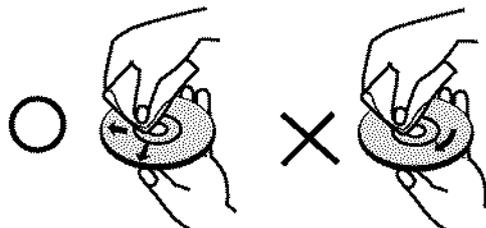

Do not use strong solvents such as alcohol, benzene, thinner, commercially available cleaners, or anti-static spray intended for older vinyl records.

Moisture Condensation

Never operate this product immediately after moving it from a cold location to a warm location. Leave it for two or three hours without operating it. If you use this product in such a situation, it may damage discs and internal parts.

Recordable and Playable Discs



DVD-RW (Digital Video Disc - ReWritable):

- DVD-RW discs can be formatted for VR mode recording or Video mode recording.
 - These Discs can be recorded on repeatedly. Recordings can be erased, then you can record again on the same Disc.
- [VR mode]
- Recordings can be extensively edited
 - Playable only on VR mode compatible players (after finalization)
- [Video mode]
- Playable on regular DVD players (after finalization)
 - Limited editing features



DVD-R (Digital Video Disc - Recordable)

- These Discs can be recorded only once. After you finalize a DVD-R, you cannot record on it or edit it.
- DVD-R discs can be only formatted to Video mode.
- Playable on regular DVD players (after finalization)
- Limited editing features



DVD-RAM (DVD - Random Access Memory)

- DVD-RAM discs can be formatted for VR mode recording.
- These Discs can be recorded on repeatedly. Recordings can be erased, then you can record again on the same Disc.
- Playable on DVD-RAM compatible players.
- Recordings can be extensively edited.
- Only DVD-RAM standard Version 2.0, 2.1 and 2.2 discs can be used in this unit.
- You cannot use the cartridge-type DVD-RAM disc in this unit.



DVD+RW (Digital Video Disc + ReWritable)

- These Discs can be recorded on repeatedly. Recordings can be erased, then you can record again on the same Disc.
- Playable on DVD+RW compatible players (automatically finalization)
- The edited contents are playable on DVD+RW compatible players only after finalization
- Recordings can be edited the title/chapter



DVD+R (Digital Video Disc + Recordable)

- These Discs can be recorded only once. After you finalize a DVD+R, you cannot record on it or edit it any more.
- Playable on DVD+R compatible players (after finalization)
- Any edited contents are not be compatible on DVD+R compatible players. (Hide, chapter combine, added chapter mark, etc.)
- Limited title/chapter editing features.



DVD+R DL (Digital Video Disc + Recordable; Double Layer)

- These Discs can be recorded only once. After you finalize a DVD+R DL, you cannot record on it or edit it any more.
- Storage space is nearly doubled with double layer DVD+R media, allowing consumers to record up to 8.5GB of video on a single DVD+R disc.
- Playable on DVD+R DL compatible players (after finalization)
- Any edited contents are not be compatible on DVD+R DL compatible players. (Hide, chapter combine, added chapter mark, etc.)
- Limited title/chapter editing features.

Recommended recordable DVD discs

DVD-R	DVD+R	DVD-RW	DVD+RW	DVD+R(DL)	DVD-RAM
Mitsubishi (8x, 16x)	Mitsubishi (8x, 16x)	Mitsubishi (4x)	Mitsubishi (4x)	Mitsubishi (2.4x, 8x)	Fujifilm (2x)
That's (8x, 16x)	Ricoh (8x, 16x)	Verbatim (4x)	SONY (4x)	Maxell (2.4x)	Mitsubishi (3x)
Verbatim (8x)	Verbatim (8x)	JVC (4x)	Imation (4x)	-	Maxell (5x)
-	-	Victor (4x)	Maxell (4x)	-	-
-	-	Maxell (4x)	Ricoh (4x)	-	-

Note: If a DVD-RW/DVD+RW discs is recorded using a personal computer or other DVD recorder, you cannot format the disc using this recorder. So if you want to use the disc on this recorder, you must format the disc using the original recorder.

Playable Discs



DVD (8 cm / 12 cm disc)

Discs such as movies that can be purchased or rented



Audio CD (8 cm / 12 cm disc)

Music CDs or CD-Rs/CD-RWs in music CD format that can be purchased



Video CD (VCD) (8 cm / 12 cm disc)

VIDEO CDs or CD-Rs/CD-RWs in VIDEO CD/Super VIDEO CD format



CD-R/CD-RW (8 cm / 12 cm disc)

CD-R/CD-RW discs that contain audio titles, DivX, MP3, WMA, or JPEG files.

Notes:

- Depending on the conditions of the recording equipment or the CD-R/RW (or DVD±R/RW) disc itself, some CD-R/RW (or DVD±R/RW) discs cannot be played on the unit.
- Do not attach any seal or label to either side (the labeled side or the recorded side) of a disc.
- Do not use irregularly shaped CDs (e.g., heart-shaped or octagonal). Doing so may result in malfunctions.
- Depending on the recording software & the finalization, some recorded discs (CD-R/RW or DVD±R/RW) may not be playable.
- DVD-R/RW, DVD+R/RW and CD-R/RW discs recorded using a personal computer or a DVD or CD Recorder may not play if the disc is damaged or dirty, or if there is dirt or condensation on the Recorder's lens.
- If you record a disc using a personal computer, even if it is recorded in a compatible format, there are cases in which it may not play because of the settings of the application software used to create the disc. (Check with the software publisher for more detailed information.)
- This recorder requires discs and recordings to meet certain technical standards in order to achieve optimal playback quality. Pre-recorded DVDs are automatically set to these standards. There are many different types of recordable disc formats (including CD-R containing MP3 or WMA files) and these require certain pre-existing conditions (see above) to ensure compatible playback.
- Customers should note that permission is required in order to download MP3 / WMA files and music from the Internet. Our company has no right to grant such permission. Permission should always be sought from the copyright owner.

Regional Code

This unit has a regional code printed on the rear of the unit. This unit can play only DVD discs labeled same as the rear of the unit or "ALL".

Notes on Regional Codes

- Most DVD discs have a globe with one or more numbers in it clearly visible on the cover. This number must match your unit's regional code or the disc cannot play.
- If you try to play a DVD with a different regional code from the unit, the message "Incorrect region code. Can't play back" appears on the TV screen.

Card useable on this unit

- Compact Flash Card (CF)
- Micro Drive (MD), ST1 MD
- Secure Digital Card (SD), Mini SD
- Multi Media Card (MMC), MMC Plus, RS MMC, MMC Mobile
- xD-Picture Card (xD)
- Memory Stick (MS), MS Duo, MS Pro, MS Pro Duo
- Compatible with: FAT 12, FAT 16, or FAT 32
- Only use the memory cards recommended above.

Regarding Write Protect

For cards that have a write protect switch, if the switch is on it will not be possible to write, erase or format the card.

Inserting/Removing the Memory Card

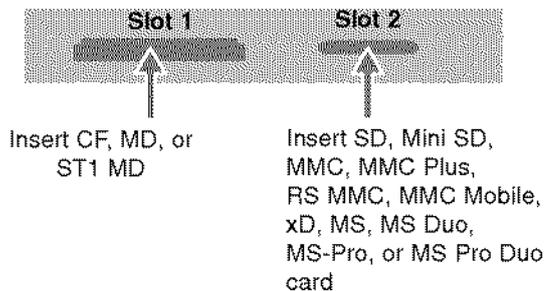

Inserting the card

Insert straight-in until it fits into place.

Removing the card

Slot 1: Withdraw the card carefully.

Slot 2: Press on the center of the card then withdraw the card carefully.

Notes:

- Keep the memory card out of reach of children. If swallowed, seek medical advice immediately.
- A memory card may not be used for this recorder
- **Do not extract the memory card while operating (play, copy, etc.).**

Using Memory Card

1. Insert a memory card.
2. Press HOME on the remote control.
3. Select [Music] or [Photo] option.
4. Select [MEMORY CARD] then press ENTER.
The Memory Card slot choice menu appears on the TV screen.

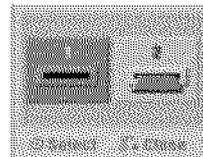

5. Use ◀ / ▶ to select the desired Memory Card slot then press ENTER.
The menu appears on the TV screen.
Details for the options are on page 17.

Front Panel

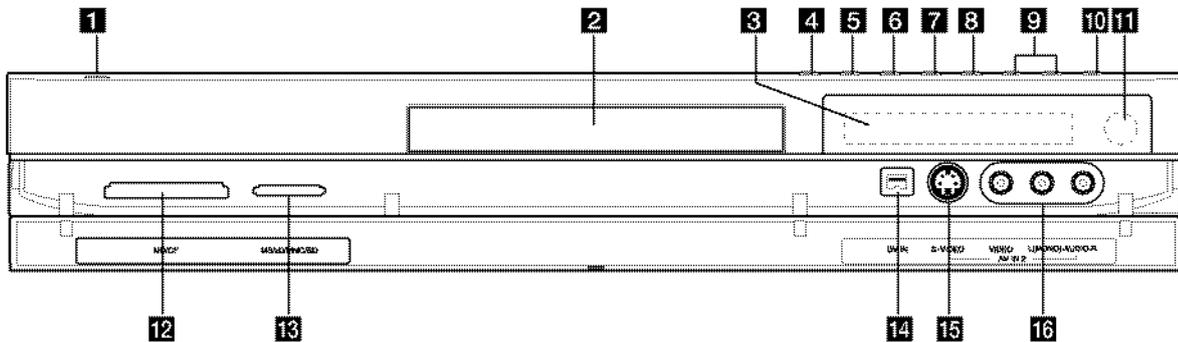

- 1 POWER button**
Switches the recorder ON or OFF.
- 2 Disc Tray**
Insert a disc here.
- 3 Display window**
Shows the current status of the recorder.
- TV: Indicates when the recorder is in TV tuner mode.
- REC: The recorder is recording.
- ⌚ : Indicates when the recorder is in timer recording or a timer recording is programmed.
- ⏱ : Shows the current status of the recorder (clock, channel number, etc.).
- 4 OPEN/CLOSE (▲)**
Opens or closes the disc tray.
- 5 RESOLUTION**
Sets the output resolution for HDMI and COMPONENT/ PROGRESSIVE SCAN VIDEO OUT jacks.
- HDMI: 1080i, 720p, 480p, 480i
 - COMPONENT: 480p, 480i
- 6 ► / ⏸ (PLAY / PAUSE)**
Starts playback.
Pause playback or recording temporarily, press again to exit pause mode.
- 7 ■ (STOP)**
Stops playback or recording.
- 8 ● (REC)**
Starts recording. Press repeatedly to set the recording time.
- 9 CH (▼/▲)**
Scans up or down through memorized channels.
- 10 PIP**
Selects PIP function on or off.
- 11 Remote Sensor**
Point the recorder remote control here.
- 12 MEMORY CARD Slot 1**
Insert a memory card (CF/MD/ST1 MD).
- 13 MEMORY CARD Slot 2**
Insert a memory card (SD/Mini SD/MMC/ MMC Plus/RS MMC/MMC Mobile/xD/MS/ MS Duo/MS-Pro/MS Pro Duo).
- 14 DV IN**
Connect the DV output of a digital camcorder.
- 15 AV IN 2 (S-VIDEO IN)**
Connect the S-Video output of an external source (TV/ Monitor, VCR, Camcorder, etc.).
- 16 AV IN 2 (VIDEO IN/AUDIO IN (Left/Right))**
Connect the audio/video output of an external source (Audio system, TV/ Monitor, VCR, Camcorder, etc.).

Remote Control

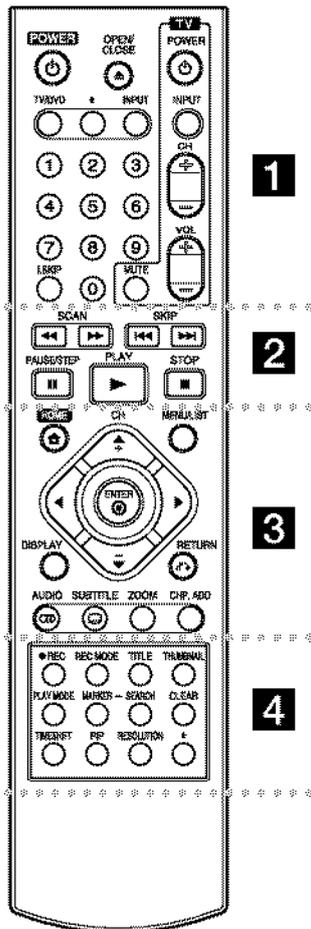

- • • • • **1** • • • • •
- POWER**: Switches the recorder ON or OFF.
- OPEN/CLOSE** (▲): Opens and closes the disc tray.
- TV/DVD**: To view channels selected by the recorder tuner or by the TV tuner.

INPUT: Changes the input to use for recording (Tuner, AV1-2, or DV IN).

0-9 numerical buttons: Selects numbered options in a menu.
I.SKIP (INSTANT SKIP): Skips 30 seconds forward during playback.
TV Control Buttons: See page 48.

- • • • • **2** • • • • •
- SCAN** (◀◀ / ▶▶): Search backward or forward.
- SKIP** (◀◀ / ▶▶): Go to next or previous chapter or track.
- PAUSE/STEP** (⏸): Pause playback or recording temporarily.
- PLAY** (▶): Starts playback.
- STOP** (■): Stops playback or recording.

- • • • • **3** • • • • •
- HOME**: Accesses or removes the HOME menu.
- MENU/LIST**: Accesses menu on a DVD disc. Switches between Title List-Original and Title List-Playlist menu.

◀ / ▶ / ▲ / ▼ (left/right/up/down): Selects an option in the menu.

ENTER (⊙)
 Acknowledges menu selection.

CH (+/-): Scans up or down through memorized channels.

DISPLAY: Accesses On-Screen Display.

RETURN (↵)
 Removes the menu.

AUDIO (⊞): Selects an audio language or audio channel.

SUBTITLE (⊞): Selects a subtitle language.

ZOOM: Enlarges DVD video image.

CHP. ADD: Inserts a chapter marker when playing/recording.

- • • • • **4** • • • • •

REC (●): Starts recording.
REC MODE: Selects the recording mode.

TITLE: Displays the disc's Title menu, if available.

THUMBNAIL: Selects a thumbnail picture.

PLAY MODE: Selects a play mode.

MARKER: Marks any point during playback.

SEARCH: Displays Marker Search menu.

CLEAR: Removes a mark on the Marker Search menu.

TIMESHIFT: To play the title being recorded and also currently being recorded appears as PIP.

PIP: Selects PIP function on or off.

RESOLUTION: Sets the output resolution for HDMI.

* button(s) is not used.

Remote Control Operation

Point the Remote Control at the remote sensor and press the buttons.

Caution

Do not mix old and new batteries. Never mix different types of batteries (standard, alkaline, etc.).

Remote Control Battery Installation

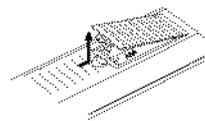

Remove the battery cover on the rear of the Remote Control, and insert two R03 (size AAA) batteries with + and - matched correctly.

Hookup and Settings

Rear Panel

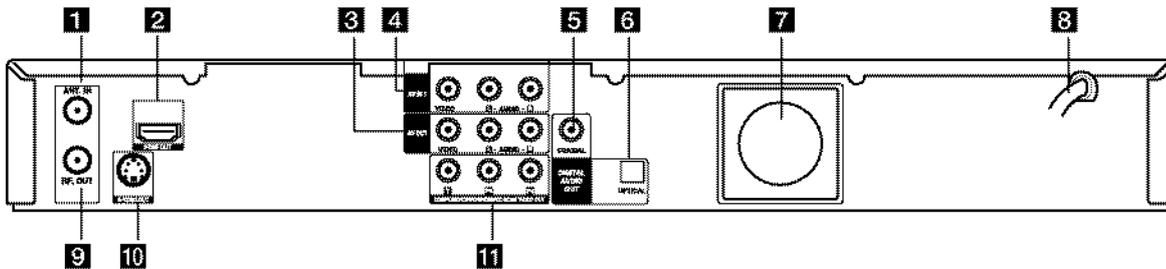

- 1 ANT. IN**
Connect the antenna to this terminal.
- 2 HDMI Connector (Type A)**
HDMI output providing a high quality interface for digital audio and video.
- 3 VIDEO / AUDIO OUT (Left/Right)**
Connect to a TV with video/audio inputs.
- 4 AV IN 1 (VIDEO IN/AUDIO IN (Left/Right))**
Connect the audio/video output of an external source (Audio system, TV/ Monitor, VCR, Camcorder, etc.).
- 5 COAXIAL (Digital audio out jack)**
Connect to digital (coaxial) audio equipment.
- 6 OPTICAL (Digital audio out jack)**
Connect to digital (optical) audio equipment.
- 7 Cooling fan**
- 8 AC Power Cord**
Plug into the power source.
- 9 RF. OUT**
Connect to a TV with RF coaxial inputs.
- 10 S-VIDEO OUT**
Connect to a S-Video Input on TV.
- 11 COMPONENT VIDEO OUT/PROGRESSIVE SCAN (Y Pb Pr)**
Connect to a TV with Y Pb Pr inputs.

Connecting an Antenna or Cable TV

1 Antenna:

Disconnect the antenna from the rear of the TV and identify the antenna cable. If it is a round 75 ohm coaxial cable connect it directly to the jack marked ANT. IN on your Recorder. If your antenna cable is flat connect it to a 300-ohm to 75-ohm antenna adaptor (not supplied) and slip the adaptor over the ANT. IN jack. Don't attempt to screw it into to the Recorder.

2 Cable TV:

If your cable connection has no converter or descrambler, unscrew the cable from your TV and attach it to the ANT. IN jack on the Recorder. If a converter is required connect a coaxial cable from the wall jack to the IN connector on the converter, and a coaxial cable from the OUT connector on the converter to the ANT. IN on your Recorder. This cable hookup permits both TV and Recorder operation.

To view or record a CATV channel

1. Tune the TV to the Recorder output channel (CH 3 or 4).
2. Set the Recorder channel selector to the cable output channel. (Example: CH3)
3. Select a channel using the cable converter.

Notes:

- With this connection, you cannot record one channel while viewing another.
- If you are using a cable box to tune channels, it is not necessary to do Auto Channel Set.

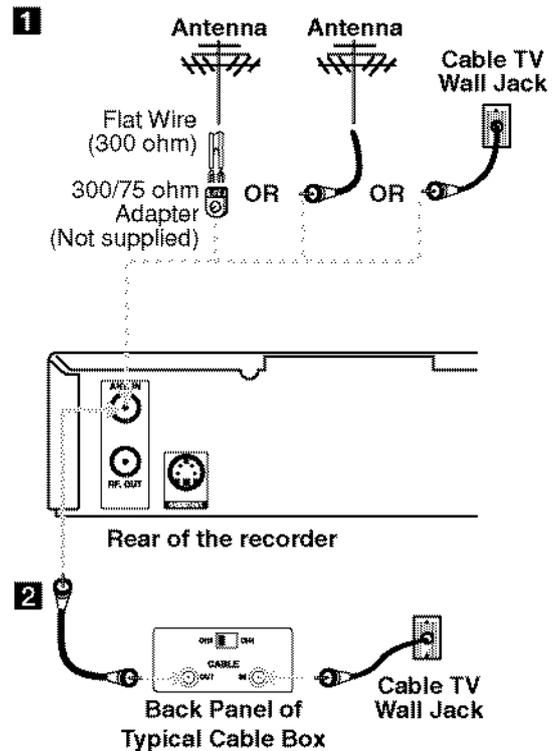

Connections to Your TV

- Make one of the following connections, depending on the capabilities of your existing equipment.

Tips

- Depending on your TV and other equipment you wish to connect, there are various ways you could connect the recorder. Use only one of the connections described below.
- Please refer to the manuals of your TV, VCR, Stereo System or other devices as necessary to make the best connections.

Caution

- Make sure the recorder is connected directly to the TV. Tune the TV to the correct video input channel.
- Do not connect the recorder's AUDIO OUT jack to the phono in jack (record deck) of your audio system.
- Do not connect your recorder via your VCR. The DVD image could be distorted by the copy protection system.

RF coaxial connection

Connect the RF OUT jack on the Recorder to the antenna in jack on the TV using the supplied 75-ohm Coaxial Cable (R).

How to set the Recorder's RF output channel

1. When the Recorder is turned off, press and hold CH (▼/▲) on the front panel for more than five seconds. [ch03] or [ch04] appears in the display window.
2. Press CH (▼/▲) to change the RF output channel (ch03 or ch04).
3. Tune the TV to this channel.

Video connection

Connect the VIDEO OUT jack on the recorder to the video in jack on the TV using the video cable (V).

Audio (Left/Right) Connection

Connect the left and right AUDIO OUT jacks of the recorder to the audio left and right IN jacks on the TV using the audio cables (A). Do not connect the recorder's AUDIO OUT jack to the phono in jack (record deck) of your audio system.

S-Video connection

Connect the S-VIDEO OUT jack on the recorder to the S-Video in jack on the TV using the S-Video cable (S).

Component Video connection

Connect the COMPONENT/PROGRESSIVE SCAN VIDEO OUT jacks on the recorder to the corresponding input jacks on the TV using an Y Pb Pr cable (C).

If your television is a high-definition or "digital ready" television, you may take advantage of the recorder's progressive scan output for higher video resolution. If your TV does not accept the Progressive Scan format, the picture will appear scrambled if you try Progressive Scan on the recorder.

- Set the resolution to 480p using RESOLUTION button for progressive signal.

Note:

Progressive scan does not work with the analog video connections (yellow VIDEO OUT jack) or S-VIDEO connection.

Caution

If the resolution is set to 720p or 1080i, the VIDEO OUT, S-VIDEO OUT and COMPONENT VIDEO OUT connections are not available.

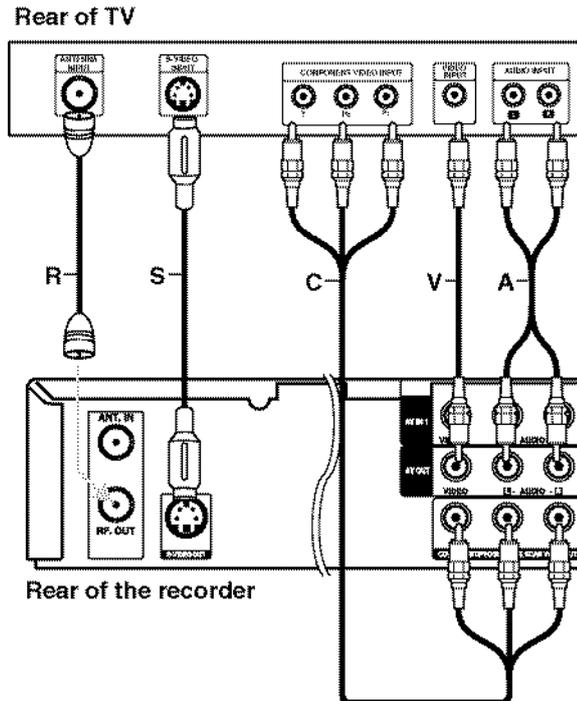

HDMI connection

If you have a HDMI TV or monitor, you can connect it to this recorder using a HDMI cable.

1. Connect the HDMI jack on the recorder to the HDMI jack on a HDMI compatible TV or monitor (H).
2. Set the TV's source to HDMI (refer to TV's Owner's manual).

Notes:

- If your TV is NOT capable of handling 96 kHz sampling frequency, set the [Sampling Freq.] option to [48 kHz] on the setup menu (See page 20). When this choice is made, this unit will automatically convert any 96 kHz signals to 48 kHz so your system can decode them.
- If your TV is not equipped with Dolby Digital and MPEG decoder, set the [Dolby Digital] and [MPEG] options to [PCM] on the setup menu (See page 20).
- If your TV is not equipped with DTS decoder, set the [DTS] options to [OFF] on the setup menu (See page 20). To enjoy DTS multi channel surround, you must connect this recorder to a DTS compatible receiver via one of this recorder's digital audio outputs.
- The arrow on the cable connector body should face up for correct alignment with the connector on the recorder.

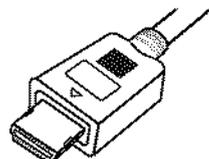

(Type A)

- If there is noise or lines on the screen, please check the HDMI cable.

Tip :

When you use HDMI connection, you can change the resolution (480i, 480p, 720p, or 1080i) for the HDMI output using RESOLUTION button.

Caution

Changing the resolution when the recorder is connected with HDMI connector may result in malfunctions. To solve the problem, turn off the recorder and then turn it on again.

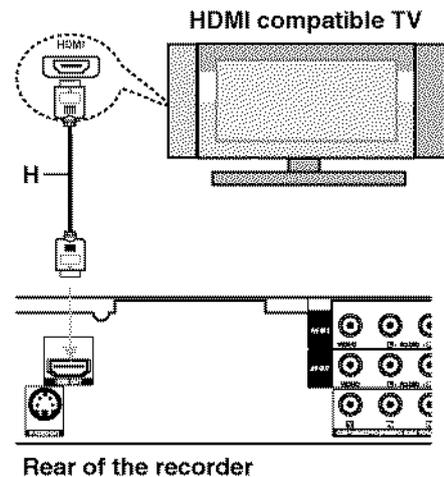

About HDMI

HDMI (High Definition Multimedia Interface) supports both video and audio on a single digital connection for use with DVD Players, Set-Top Boxes, and other AV devices.

HDMI was developed to provide the technologies of HDCP (High Definition Contents Protection). HDCP is used to protect digital content transmitted and received.

HDMI has the capability to support standard, enhanced, or high-definition video plus standard to multi-channel surround-sound audio. HDMI features include uncompressed digital video, a bandwidth of up to 5 gigabytes per second, one connector (instead of several cables and connectors), and communication between the AV source and AV devices such as DTVs.

HDMI, the HDMI logo and High-Definition Multimedia Interface are trademarks or registered trademarks of HDMI licensing LLC.

Additional Information for HDMI

- When you connect a HDMI or DVI compatible device make sure of the followings:
 - Try switching off the HDMI/DVI device and this recorder. Next, switch on the HDMI/DVI device and leave it for around 30 seconds, then switch on this recorder.
 - The connected device's video input is set correctly for this unit.
 - The connected device is compatible with 720(1440)x480i, 720x480p, 1280x720p, or 1920x1080i video input.
- Not all HDCP-compatible DVI devices will work with this recorder.
 - The picture will not be displayed properly with non-HDCP device.

Connecting to an Amplifier

Connecting to an amplifier equipped with two channel analog stereo or Dolby Pro Logic II/ Pro Logic

Connect the Left and Right AUDIO OUT jacks on the recorder to the audio left and right in jacks on your amplifier, receiver, or stereo system, using the audio cables (A).

Connecting to an amplifier equipped with two channel digital stereo (PCM) or to an Audio/ Video receiver equipped with a multi-channel decoder (Dolby Digital™, MPEG 2, or DTS)

1. Connect one of the recorder's DIGITAL AUDIO OUT jacks (OPTICAL O or COAXIAL X) to the corresponding in jack on your amplifier. Use an optional digital (optical O or coaxial X) audio cable.
2. You will need to activate the recorder's digital output. (See "Audio Settings" on page 20.)

Digital Multi-channel sound

A digital multi-channel connection provides the best sound quality. For this you need a multi-channel Audio/Video receiver that supports one or more of the audio formats supported by your recorder (MPEG 2, Dolby Digital and DTS). Check the receiver manual and the logos on the front of the receiver.

Caution:

Due to the DTS Licensing agreement, the digital output will be in DTS digital out when DTS audio stream is selected.

Notes:

- If the audio format of the digital output does not match the capabilities of your receiver, the receiver will produce a strong, distorted sound or no sound at all.
- Six Channel Digital Surround Sound via digital connection can only be obtained if your receiver is equipped with a Digital Multi-channel decoder.
- To see the audio format of the current DVD in the on-screen display, press AUDIO.
- This recorder does not perform internal (2 channel) decoding of a DTS sound track. To enjoy DTS multi channel surround, you must connect this recorder to a DTS compatible receiver via one of this recorder's digital audio outputs.

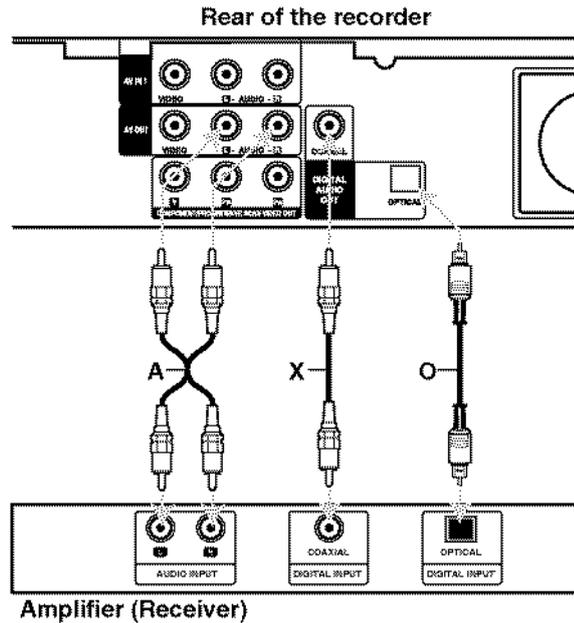

Manufactured under license from Dolby Laboratories. "Dolby", "Pro Logic", and the double-D symbol are trademarks of Dolby Laboratories.

"DTS" and "DTS Digital Out" are trademarks of Digital Theater Systems, Inc.

Accessory Audio/Video (A/V) Connections

Connecting to the AV IN 1 or AV IN 2 Jacks

Connect the input jacks (AV1, AV2) on the recorder to the audio/video out jacks on your accessory component, using audio/video cables.

Note:

If you use the S-VIDEO IN jack on the front panel, the VIDEO IN jack on the front panel is not available.

Connecting a Digital Camcorder

Using the front panel DV IN jack, it is possible to connect a DV digital camcorder and digitally transfer DV tapes to DVD.

Use a DV cable (not supplied) to connect the DV in/out jack of your DV camcorder to the front panel DV IN jack of this recorder.

Note:

This jack is for connection to DV digital camcorder only. It is not compatible with digital satellite tuners or D-VHS video decks.

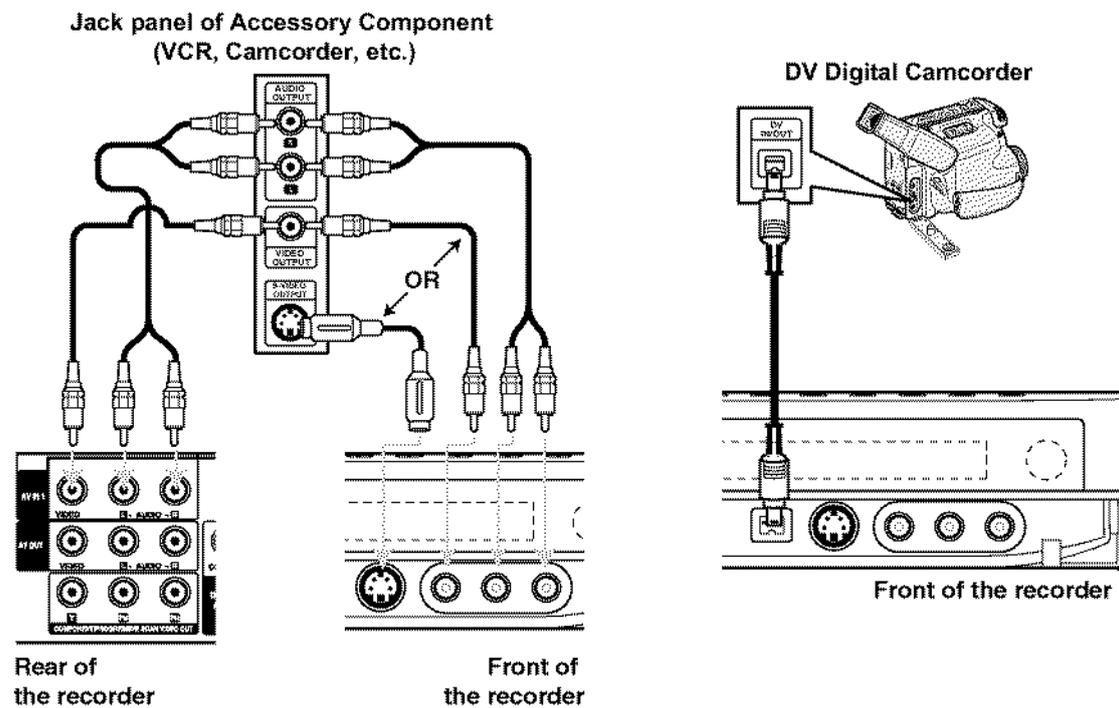

Auto Set Up

After the POWER is pressed for the first time to turn on the unit or resetting the unit, the Initial Setup Wizard function sets the language, clock and tuner channels automatically.

1. Select a language for the Setup menu and on-screen display. Use ▲ / ▼ to select a language then press ENTER.

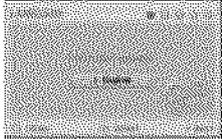

2. Please check your antenna connections. Press ► to move next step.



3. Please ENTER while [Start] option is selected. The tuner will automatically cycle through all available channels in the area and place them in the tuner's memory.

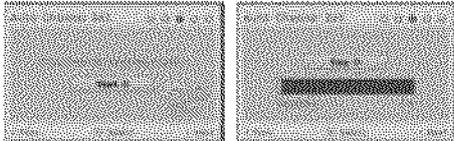

4. Use ▲ / ▼ to select the Clock Set option then press ENTER.

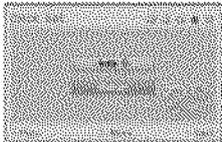

- [Auto]
 - 1) Use ▲ / ▼ / ◀ / ▶ to choose Band, PBS channel, Time Zone, Daylight Savings options. (Details are on page 19)
 - 2) Press ENTER to confirm your setting.
 - [Manual]:
 - 1) Enter the necessary information for date and time.
 - ◀ / ▶ (left/right): Moves the cursor to the previous or next column.
 - ▲ / ▼ (up/down): Changes the setting at the current cursor position.
 - 2) Press ENTER to confirm your setting.
5. Press ENTER while [Close] is highlighted to finish setup.

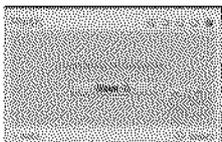

Using the Home Menu

From the Home Menu screen you can access all the Media for playback and recording of the recorder.

1. Press HOME to display the Home Menu screen. The unit will be in TV viewing mode always when the Home menu appears.
2. Use ◀ / ▶ buttons to select a main option you want. Sub options appears.
3. Use ▲ / ▼ and ENTER buttons to select the sub option you want.

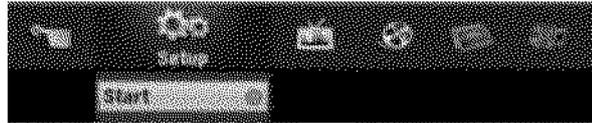

4. To exit the HOME menu, press HOME.

Setup

- **Start:** Displays Setup menu.

TV

- **Auto Ch. Scan:** Displays [Auto Channel Set] menu. (See page 18)
- **Ch. Edit:** Displays [CH. Add/Del] menu. (See page 18)
- **Timer Record:** Displays [Timer Record List] menu. (See page 36)

Movie

- **DISC:**
 - Displays Title List menu for recordable disc (page 39)
 - Displays Movie List menu for DivX disc. (page 29)
 - Plays back Video CD or DVD-Video disc (page 25-28).

Photo (See page 31-32)

- **DISC:** Displays Photo List menu for disc.
- **MEMORY CARD:** Displays memory card choice menu. (See page 8)

Music (See page 30)

- **DISC:** Displays Music List menu for disc.
- **MEMORY CARD:** Displays memory card choice menu. (See page 8)

Easy Menu

- **Disc Manager:** Displays the Disc Settings menu. (See page 22-23)
- **Rec. Mode:** Displays the menu to select the record mode. (See page 22)
- **DV Input:** Set the recorder to the DV input mode.

Initial Settings

In this menu system, there are several ways to customize the settings provided. Most menus consist of three levels to set up the options, but some require greater depth for the variety of settings.

General Operation

1. Press HOME and select [Setup] option.
2. Select [Start] option then press ENTER. The Setup menu appears.

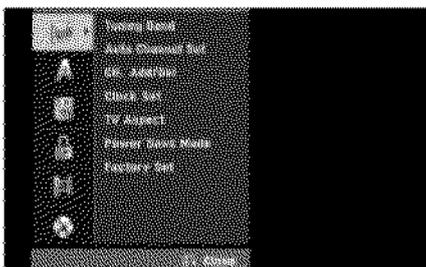

3. Use ▲ / ▼ to select the desired option.
4. While the desired item is selected, press ► to move to the second level.
5. Use ▲ / ▼ to select the second desired option.
6. Press ► to move to the third level.
7. Use ▲ / ▼ to select the desired setting then press ENTER to confirm your selection. Some items require additional steps.
8. Press RETURN (↵) repeatedly to exit the Setup menu.

Note:

Press ◀ to go back to the previous level.

General Settings

Tuning Band Select

1. Select the [Tuning Band] option then press ►.
2. Use ▲ / ▼ to select the tuning band (TV or CATV) option then press ENTER.
TV: If you are using a standard antenna to receive channels.
CATV: If you are using basic cable to receive channels.

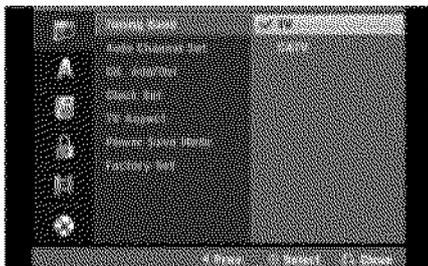

Auto Channel Set

Connect the Recorder to the desired type of antenna or cable TV system as shown on page 12. This Recorder is equipped with a frequency synthesized tuner capable of receiving up to 181 channels. These include VHF channels 2-13, UHF channels 14-69 and CATV channels 1-125.

1. Select the [Auto Channel Set] option.
2. Press ► to move to the third level. [Start] icon is highlighted.
3. Press ENTER to begin the channel search. The tuner will automatically cycle through all available channels in the area and place them in the tuner's memory.

Note:

After the Auto Channel Set proceeding is complete, make sure the Tuning Band is set appropriately (TV or CATV) on tuning band, follow steps 1~2 as shown previous (Tuning Band Select) to choose the correct Tuning Band (TV or CATV).

To Add or Erase Channels

This feature allows you to add to or erase channels from memory manually.

1. Select the [CH. Add/Del] option.
2. Press ► to move to the third level. [Edit] icon is highlighted.
3. Press ENTER and the Channel Edit menu appears.

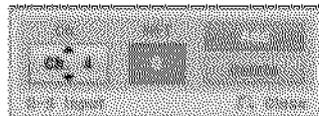

4. Use ▲ / ▼ or number buttons to select a channel then press ►.
5. If you want to obtain a clearer picture, tune the [MFT] option using ▲ / ▼ then press ►. [Add] or [Delete] icon is highlighted.
6. Press ENTER to confirm your setting.
7. Repeat steps 4-6 to add or erase additional channels.
8. Press HOME or RETURN (↵) to exit the menu.

Auto Clock Set

In the Auto option, the Recorder looks for a channel carrying XDS (Extended Data Services) information. XDS updates the clock using the Coordinated Universal Time.

1. Select [Clock set] option then press ►.
2. Use ▲ / ▼ to select [Auto] option then press ENTER.
3. Use ▲ / ▼ / ◀ / ▶ to choose the [Band], [PBS Ch.], [Time Zone], and [Daylight Savings] options.
 [Band] Choose your TV BAND (TV or CATV).
 [PBS Ch.] Choose your local PBS channel.
 [Time Zone] Choose your Time Zone manually. When Timezone is set to Auto, the Recorder will use XDS information to determine the proper setting.
 [Daylight Savings] Choose Auto, ON, or OFF. When it is set to Auto, the Recorder will use XDS information to determine the proper setting.
4. Press ENTER to confirm your setting.

Note :

The Auto Clock Feature enables the Recorder to set up the clock when the Recorder is turned off.

Manual Clock Set

If your local TV station does not send date and time information, or sends incorrect information, you can set the clock manually.

1. Select [Clock set] option then press ►.
2. Use ▲ / ▼ to select [Manual] option then press ENTER.
3. Enter the necessary information for year, date and time.
 ◀ / ▶ (left/right): Moves the cursor to the previous or next column.
 ▲ / ▼ (up/down): Changes the setting at the current cursor position.
4. Press ENTER to confirm your setting.

TV Aspect

Selects the aspect ratio of the connected TV (4:3 standard or wide).

- [4:3 Letter Box] Select this when connecting to a 4:3 screen TV. Displays a wide picture with bands on the upper and lower portions of the screen.
- [4:3 Pan Scan] Select this when connecting to a 4:3 screen TV. Automatically displays a wide picture on the entire screen and cuts off the portions that do not fit.
- [16:9] Select this when connecting to a wide-screen TV or TV with a wide mode function.

Power Save Mode

You can set up the unit into an economic power save mode. Nothing is displayed in the display window when the unit is turned off.

- [OFF] Power Save Mode is not active.
- [ON] Power Save Mode is active.

Note:

The Power Save Mode is not available in the standby mode for the timer recording.

Factory Set

If you need to, you can reset the Recorder to all its factory settings. Select "Set" icon then press ENTER and auto setup menu will appear, see page 17.

Note:

Some options can not be reset. (Rating, Password, and Area Code)

Language Settings

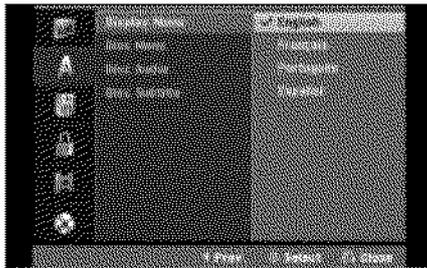

Display Menu

Select a language for the Setup menu and on-screen display.

Disc Menu/Audio/Subtitle

- [Original] Refers to the original language in which the disc was recorded.
- [Others] To select another language, press number buttons then ENTER to enter the corresponding 4-digit number according to the language code list in the reference chapter (see page 47). If you make a mistake while entering number, press CLEAR repeatedly to delete numbers one by one then correct it.
- [Off] (for Disc Subtitle) : Turn off Subtitle.

Audio Settings

Each DVD disc has a variety of audio output options. Set the recorder's Audio Output according to the type of audio system you use.

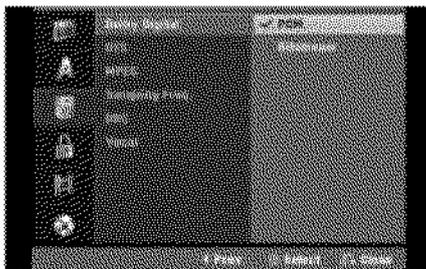

Dolby Digital / DTS / MPEG

- [Bitstream]: Select "Bitstream" if you connect the recorder's DIGITAL AUDIO OUT jack to an amplifier or other equipment with a Dolby Digital, DTS or MPEG decoder.
- [PCM] (for Dolby Digital / MPEG): Select when connected to a two-channel digital stereo amplifier. DVDs encoded in Dolby Digital or MPEG will be automatically downmixed to two-channel PCM audio.
- [Off] (for DTS): If you select "Off", the DTS signal is not output through the DIGITAL AUDIO OUT jack.

Sampling Frequency

If your receiver or amplifier is NOT capable of handling 96 kHz signals, select [48 kHz]. When this choice is made, this unit will automatically convert any 96 kHz signals to 48 kHz so your system can decode them.

If your receiver or amplifier is capable of handling 96 kHz signals, select [96 kHz]. When this choice is made, this unit will pass each type of signal through without any further processing.

DRC (Dynamic Range Control)

With the DVD format, you can hear a program's soundtrack in the most accurate and realistic presentation possible, thanks to digital audio technology. However, you may wish to compress the dynamic range of the audio output (the difference between the loudest sounds and the quietest ones). Then, you may listen to a movie at a lower volume without losing clarity of sound. Set DRC to [ON] for this effect.

Vocal

Set Vocal to [ON] only when a multi-channel karaoke DVD is playing. The karaoke channels on the disc will mix into normal stereo sound.

Lock (Parental Control) Settings

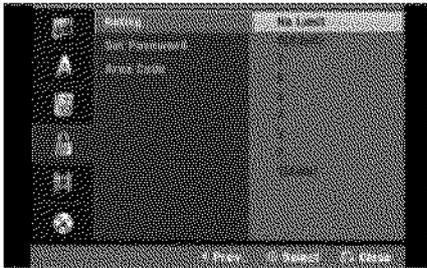

Rating

Blocks playback of rated DVDs based on their content. Not all discs are rated.

1. Select [Rating] option then press ►.
2. To access the Rating, Password and Area Code features, you must input the 4-digit security code you created.
If you have not yet entered a security code you are prompted to do so. Input a 4-digit code. Enter it again to verify. If you make a mistake while entering number, press CLEAR repeatedly to delete numbers one by one then correct it.
3. Select a rating using the ▲ / ▼ buttons.
[1] - [8]: Rating one (1) has the most restrictions and rating eight (8) is the least restrictive.
[No Limit]: If you select [No Limit], parental control is not active and the disc plays in full.
4. Press ENTER to confirm your rating selection.

Note:

If you set a rating for the recorder, all disc scenes with the same rating or lower are played. Higher rated scenes are not played unless an alternate scene is available on the disc. The alternative must have the same rating or a lower one. If no suitable alternative is found, playback stops. You must enter the 4-digit password or change the rating level in order to play the disc.

Set Password

1. Select [Set Password] option then press ►.
2. Follow step 2 as shown "Rating" on left.
To change the password, select the [Change], press ENTER and input the new 4-digit code. Input it again to verify.
To delete the password, select [Delete] then press ENTER.

If you forget your 4-digit code

If you forget your password, to clear the current password, follow the procedure below.

1. Display Setup menu then select an 1 level icon.
2. Use the Number buttons to enter the 6-digit number "210499".
3. Select [Yes] then press ENTER. The 4-digit password is cleared. Enter a new code.

Area Code

Enter the code of an area whose standards were used to rate the DVD video disc, referring to the list (See "Area Codes", page 47.).

1. Select [Area Code] option then press ►.
2. Follow step 2 as shown "Rating" on left.
3. Select the first character using the ▲ / ▼ buttons.
4. Shift the cursor using ► buttons and select the second character using ▲ / ▼ buttons.
5. Press ENTER to confirm your area code selection.

Recording Settings

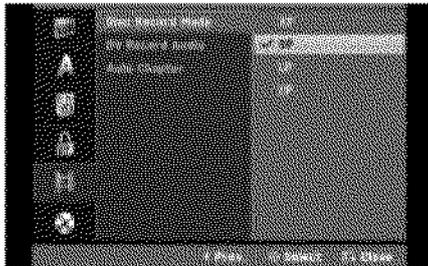

Disc Record Mode

You can set the picture quality for recording; XP (High Quality), SP (Standard Quality), LP (Low Quality), EP (Extend Quality).

DV Recording Audio

You need to set this if you have a camcorder using 32kHz/12-bit sound connected to the front panel DV IN jack.

Some digital camcorders have two stereo tracks for audio. One is recorded at the time of shooting; the other is for overdubbing after shooting.

On the Audio 1 setting, the sound that was recorded while shooting is used.

On the Audio 2 setting, the overdubbed sound is used.

Auto Chapter

When recording in Video mode, chapter markers are put in specified setting. You can change this interval to 5 minutes or 10 minutes. If you select [None], switch off automatic chapter marking altogether with the [None] setting.

Disc Settings

Initialize

If you load a completely blank disc, the recorder will initialize the disc.

DVD-R: The recorder initialize the disc to Video mode. The recording mode will always be Video mode.

DVD-RW/DVD+RW/DVD+R (DL)/DVD-RAM: The Initialize menu will appear. Select [OK] then press ENTER. DVD-RW disc is initialized to Video mode.

Also, you can reformat the DVD-RW/DVD+RW/DVD-RAM from the Setup menu as below.

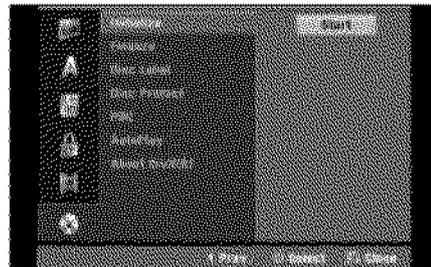

1. Select [Initialize] option then press ►.
2. Press ENTER while [Start] is selected. Initialize menu appears.
3. Use ◀ / ▶ to select a desired mode (VR Mode or Video Mode) then press ENTER. Confirm message will appear. For DVD+RWs, go to step 4.
4. Use ◀ / ▶ to select [OK] then press ENTER. It takes a few moments to initialize the disc.

Caution

If you want to change the disc format, everything recorded on the disc will be erased.

Disc Settings (Continued)

Finalize

Finalizing 'fixes' the recordings in place so that the disc can be played on a regular DVD player or computer equipped with a suitable DVD-ROM drive. Finalizing a Video mode disc creates a menu screen for navigating the disc. This is accessed by pressing MENU/LIST or TITLE.

Caution

Once you have finalized a DVD-R and DVD+R disc, you cannot edit or record anything else on that disc except DVD+RW. However, you can record and edit a DVD-RW disc by choosing [Unfinalize] option.

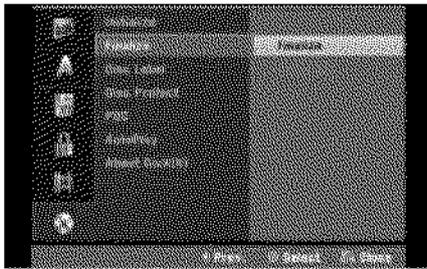

1. Select [Finalize] option then press ►.
2. Press ENTER while [Finalize] is selected. Finalize menu appears.
3. Select [OK] then press ENTER. The recorder starts finalizing the disc.

Note:

- How long finalization takes depends on the type of disc, how much is recorded on the disc, and the number of titles on the disc.
- DVD+R DL disc can take up to 30 minutes to finalize.

Tips

- If you load a DVD-RW that has already been finalized, you can 'Unfinalize' it by choosing Unfinalize from the Finalize menu. After doing this, you can edit and re-record onto the disc.
- You cannot unfinalize a DVD-R and DVD+R (DL) disc.
- If [Disc Protect] option is set to [ON], the finalize is not available. To finalize, set [Disc Protect] option to [OFF].

Disc Label

Use this to enter a name for the disc. This name appears when you load the disc and when you display disc information on-screen.

- The disc name can be up to 32 characters long.
 - For discs formatted on a different recorder, you will see only a limited character set.
1. Select [Disc Label] option then press ►.
 2. Press ENTER while [Edit] is selected. Keyboard menu appears. To enter characters, see page 43.

Disc Protect

When recording in DVD-RAM / DVD+RW / +R disc or VR mode formatted DVD-RW disc, set to [ON] to prevent accidental recording, editing or deleting of the disc loaded. If you need to unlock the disc to make edits, select [OFF].

PBC

PBC stands for Playback Control and refers to special menus and navigation features that are available on some Video CDs.

- [ON] Video CDs are played according to the PBC, if available.
- [OFF] Video CDs are played the same way as Audio CDs.

Auto Play

You can set up the unit so a DVD disc automatically starts playing whenever the DVD is inserted. If Auto Play mode is set to On, this unit will search for title that has the longest playback time and then play back the title automatically.

Note:

The Auto Play function may not work for some DVDs.

DivX Registration Code **DivX**

We provide you the DivX® VOD (Video On Demand) registration code that allows you to rent and purchase videos using the DivX® VOD service. For more information, visit www.divx.com/vod.

1. Select [About DivX(R)] option then press ►.
2. Press ENTER while [View] is selected and the registration code will appear.
3. Use the registration code to purchase or rent the videos from DivX® VOD service at www.divx.com/vod. Follow the instructions and download the video onto a disc for playback on this unit.

Note:

All the downloaded videos from DivX® VOD can only be played back on this unit.

General Explanation of On-Screen Display

This manual gives basic instructions for operating the recorder. Some DVDs require specific operation or allow only limited operation during playback. When this occurs, the symbol  appears on the TV screen, indicating that the operation is not permitted by the recorder or is not available on the disc.

Displaying Information While Watching TV

During viewing the TV, press **DISPLAY** to display/remove the information displayed on-screen.

Indicates channel number, station name, and audio signal (STEREO, MONO) received by the tuner.

Indicates the record mode, free space, and elapsed time progress bar.

Indicates disc name and format.

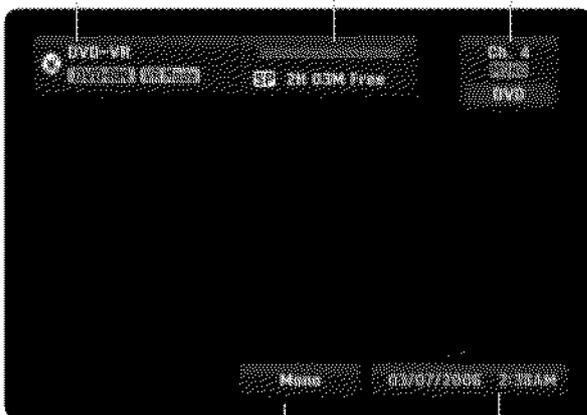

Indicates current audio channel.

Indicates current date and time.

Displaying Disc Information on-screen

You can display various information about the disc loaded on-screen.

1. Press **DISPLAY** once to show current status.



2. Press **DISPLAY** once again to show various playback information. The items displayed differ depending on the disc type or playing status.



3. You can select an item by pressing **▲ / ▼** and change or select the setting by pressing **◀ / ▶**. For details about each item, see the pages in parentheses.
 - [Title]: Current title (or track) number/total number of titles (or tracks) (page 27)
 - [Chapter]: Current chapter number/total number of chapters (page 25)
 - [Time]: Elapsed playing time (page 27)
 - [Audio]: Selected audio language (DVD VIDEO only) or audio channel (page 26)
 - [Subtitle]: Selected subtitle (page 26)
 - [Angle]: Selected angle/total number of angles (page 27)
 - [Sound]: Selected sound mode (page 28)

Note:

If no button is pressed for 10 seconds, the on-screen display disappears.

Playback

General Playback Features

1. Load your chosen disc in the tray, with the playback side down.
2. Starts playback using HOME menu (see page 17).
3. To stop the playback, press STOP (■).
The unit records the stopped point, depending on the disc. "■■■" appears on the screen briefly.
Press PLAY (▶) to resume playback (from the scene point). If you press STOP (■) again or unload the disc ("■" appears on the screen.), the unit will clear the stopped point.
4. Press OPEN/CLOSE (▲) to remove the disc.
Press OPEN/CLOSE (▲) to close disc tray or press POWER (⏻), the disc tray closes automatically and unit turns off.

Note:

If Parental Control is set and the disc is not within the Rating settings (not authorized), the 4-digit code must be entered and/or the disc must be authorized (see "Rating", on page 21).

Buttons	Operations	Discs
OPEN / CLOSE (▲)	Opens or closes the disc tray.	All Discs
PAUSE/STEP (⏸)	During playback, press PAUSE/STEP (⏸) to pause playback. Press PAUSE/STEP (⏸) repeatedly to play Frame-by-Frame. Tip: You can advance or back up the picture frame-by-frame by pressing ◀ / ▶ repeatedly during PAUSE mode. The picture frame-by-frame in reverse is not available for Video CD.	All Discs DVD ALL VCD
SKIP (⏮ / ⏭)	During playback, press SKIP (⏮ or ⏭) to go to the next chapter/track or to return to the beginning of the current chapter/track. Press SKIP ⏮ twice briefly to step back to the previous chapter/track. Tips: <ul style="list-style-type: none"> • To go directly to any chapter during DVD playback, press DISPLAY twice and press ▲ / ▼ to select the chapter icon. Then, input the chapter number or use ◀ / ▶. • On an Audio CD, to go directly to any track, enter the track number using the numbered buttons (0-9) during playback. 	DVD ALL VCD DivX ACD MP3 WMA
SCAN (◀◀ / ▶▶)	During playback, press SCAN (◀◀ or ▶▶) repeatedly to select the required scan speed. DVD; 5 steps Video CD, DivX, Audio CD; 3 steps While the playback is paused, press SCAN (◀◀ or ▶▶) repeatedly to play in slow motion DVD; 4 steps Video CD; 3 steps (Forward only)	DVD ALL VCD DivX ACD DVD ALL VCD
ZOOM	During playback or pause mode, press ZOOM to enlarge the video image. (x1 size → x2 size → x4 size → x1 size (normal size)) You can move through the zoomed picture using ◀ ▶ ▲ ▼ buttons.	DVD ALL

General Playback Features (Continued)

Buttons	Operations	Discs
PLAY MODE	<p>For repeat playback During playback, press PLAY MODE repeatedly to select a desired repeat mode. DVD (Chapter/Title/Off) VR mode DVD-RW (Chapter/Title/All/Off) Video CD, Audio CD (Track/All/Off) MP3/WMA (Track/Folder/Off)</p> <p>Notes:</p> <ul style="list-style-type: none"> On a Video CD with PBC, you must set PBC to [OFF] in the Setup menu to use the Repeat function. See page 23. If you press SKIP (▶▶) once during Repeat Chapter (Track) playback, the repeat playback cancels. 	<p>DVD ALL VCD ACD MP3 WMA</p>
	<p>For repeat A-B During playback, press PLAY MODE repeatedly to select point A then press ENTER to select point B Repeats a sequence from point A (Starting point) to point B (End point).</p>	<p>DVD ALL VCD ACD</p>
	<p>For random playback During playback, press PLAY MODE repeatedly to display "RANDOM". The unit automatically begins Random Playback. To return to normal playback, press PLAY MODE repeatedly until "NORMAL" appears on the TV screen.</p> <p>Tip: By pressing SKIP (▶▶) during Random playback, the unit selects another title (track) and resumes Random playback.</p>	<p>Karaoke DVD</p>
TITLE	If the current DVD title has a menu, the title menu appears on the screen. Otherwise, the disc menu may appear.	DVD
MENU/LIST	The disc menu appears on the screen.	DVD
SUBTITLE ()	During playback, press SUBTITLE then press ◀ / ▶ repeatedly to select a desired subtitle language.	DVD
AUDIO ()	Press AUDIO then press ◀ / ▶ repeatedly to hear a different audio language or audio track.	DVD
	<p>Note: Some discs feature both Dolby Digital and DTS soundtracks. There is no analog audio output when DTS is selected. To listen to the DTS soundtrack, connect this recorder to a DTS decoder via one of the digital outputs. See page 15 for connection details.</p> <p>Press AUDIO then press ◀ / ▶ repeatedly during playback to hear a different audio channel (STEREO, LEFT or RIGHT).</p> <p>With DVD-RW discs recorded in VR mode that have both a main and a Bilingual audio channel, you can switch among Main (L), Sub (R), or Main+sub (L+R).</p>	<p>-RW_{VR} -RW_{Video} RAM +RW -R +R VCD DivX</p>
I.SKIP	Press I.SKIP repeatedly during playback to skip forward 30 seconds.	DVD ALL

If a menu screen is displayed **DVD** **VCD**

The menu screen may be displayed first after loading a DVD or Video CD which contains a menu.

DVD

Use the ◀ / ▶ / ▲ / ▼ buttons to select the title/chapter you want to view, then press ENTER to start playback.

Press TITLE or MENU/LIST to return to the menu screen.

VCD

- Use the number buttons to select the track you want to view.
Press RETURN (↵) to return to the menu screen.
- Menu setting and the exact operating procedures for using the menu may differ depending on the disc. Follow the instructions on the each menu screen. You may also set PBC to [OFF] under Setup menu (see page 23).

Moving to another TITLE **-RWVR** **-RWVideo**

RAM **+RW** **-R** **+R** **DVD** **DivX**

When a disc has more than one title, you can move to another title as follows:

- Press DISPLAY twice during playback then use ▲ / ▼ to select the title icon. Then, press the appropriate numbered button (0-9) or ◀ / ▶ to select a title number.

Time Search **-RWVR** **-RWVideo** **RAM** **+RW**

-R **+R** **DVD** **DivX**

To start playing at any chosen time on the disc:

1. Press DISPLAY twice during playback. The time search box shows the elapsed playing time.
2. Press ▲ / ▼ to select the time clock icon and ":-:--:" appears.
3. Input the required start time in hours, minutes, and seconds from left to right.
If you enter the wrong numbers, press ◀ / ▶ to move the under bar (|) to the wrong number. Then enter the correct numbers.
4. Press ENTER to confirm. Playback starts from the selected time.

Marker Search **1 / 8**

-RWVR **-RWVideo** **RAM** **+RW** **-R** **+R**
DVD **VCD**

To enter a Marker

You can start playback from up to six memorized points. To enter a marker, press MARKER at the desired point on the disc. The Marker icon appears on the TV screen briefly. Repeat to enter up to six markers.

To Recall or Clear a Marked Scene

1. During disc playback, press SEARCH. The marker search menu appears on the screen.
2. Use ◀ / ▶ / ▲ / ▼ to select a marked scene that you want to recall or clear.
3. Press ENTER and playback starts from the marked scene. Or, press CLEAR and the marked scene is erased from the marker search menu.



Camera Angle **DVD**

If the disc contains scenes recorded at different camera angles, you can change to a different camera angle during playback.

1. Press DISPLAY during playback. The On-Screen Display appears on the TV screen.
2. Use ▲ / ▼ to select the Angle icon in the On-Screen Display.
3. Use ◀ / ▶ to select a desired angle.
The number of the current angle appears on the TV screen.

Tip:

The ANGLE indicator will blink on the TV screen at scenes recorded at different angles to indicate that angle switching is possible.

3D Surround **-RW_{VR}** **-RW_{Video}** **RAM** **+RW** **-R** **+R** **DVD** **VCD** **DivX**

This unit can produce a 3D Surround effect, which simulates multi-channel audio playback from two conventional stereo speakers, instead of the five or more speakers normally required to listen to multi-channel audio from a home theater system.

1. Press DISPLAY during playback. The On-Screen Display appears on the TV screen.
2. Use ▲ / ▼ to select the Sound icon in the On-Screen Display.
3. Use ◀ / ▶ to select "3D SUR".
To turn off the 3D Surround effect, select "NORMAL".

Finding Locations on a Disc **VCD**

You can directly access any point on a video CD using this function. Use this function only while a video CD is playing. Playback jumps to the point specified.

1. Press SEARCH during playback.
The progress bar appears on the TV screen.
2. Use ◀ / ▶ to find a start position for playback.
3. Press ENTER to confirm the selected position.
Playback starts from the selected position.

Note:

This function works only when no marker is memorized.

Last Condition Memory **DVD**

This recorder memorizes the user settings for the last disc that you have viewed. Settings remain in memory even if you remove the disc from the recorder or switch off the recorder. If you load a disc that had its settings memorized, the latest stop position is automatically recalled.

Notes:

- Settings are stored in memory for use any time.
- This recorder does not memorize settings of a disc if you switch off the recorder before commencing to play it.

PIP (Picture in Picture) **-RW_{VR}** **-RW_{Video}** **RAM** **+RW** **-R** **+R** **DVD** **VCD**

This function enables you to view the stored stations in sub picture during playback.

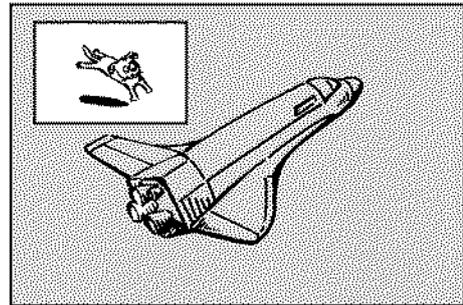

On and off

Press PIP to switch on the sub picture, press this button again to switch it off.

Input mode selection for sub picture

Press INPUT to select the input mode for the sub picture. Each time this button is pressed, each input mode for the sub picture is displayed as shown below.

Tuner → AV1 → AV2

Program selection for sub picture

Use CH (+/-) to change the program when sub picture's input is set to tuner. The selected program number is displayed on the TV screen. You can view the selected program by pressing STOP (■).

Sub picture position change

Press ◀ / ▶ repeatedly until desired position is achieved. The sub picture moves clockwise or counterclockwise.

Playing a DivX Movie File

The recorder can play DivX files. Before playing DivX files, read "DivX file requirement" on right.

Note:

This recorder cannot play back the DivX file(s) in the Memory Card.

1. Press HOME.
2. Select [Movie] option.
3. Select a media that contains DivX file(s) then press ENTER.
The [Movie List] menu appears on the TV screen.

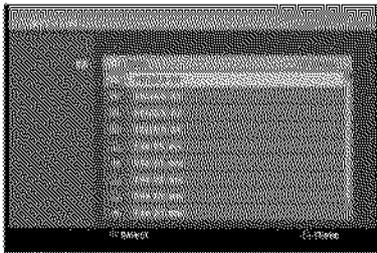

4. Press ▲ / ▼ to select a folder, and press ENTER. A list of files in the folder appears. If you are in a file list and want to return to the Folder list, use the ▲ / ▼ buttons on the remote to highlight [Folder] and press ENTER.
5. If you want to view a particular file, press ▲ / ▼ to highlight a file and press PLAY (▶). You can use variable playback functions. Refer to pages 25-28.
6. Press STOP to stop the playback. The [Movie List] menu appears.

Notice for displaying the DivX subtitle

If the subtitle does not display properly, please follow the steps below.

1. Press PAUSE/STEP when the subtitle appears.
2. Press and hold SUBTITLE about 3 seconds. The language code will appear.
3. Press ◀ / ▶ to select another language code until the subtitle is displayed properly.
4. Press PLAY (▶) to continue playback.

Movie List menu options

1. Press ▲ / ▼ to select a folder/file on the [Movie List] menu then press ENTER.
[Movie List] menu options appear.
The menu options displayed differ depending on the selected media.
2. Press ▲ / ▼ / ◀ / ▶ to select an option, and press ENTER.
 - [Play] Start playback the selected title.
 - [Open] Opens the folder and a list of files in the folder appears

DivX file requirement

Available resolution size: 720x576 (W x H) pixel

DivX file extensions: ".avi", ".divx"

Playable DivX subtitle: ".smi", ".srt",
".sub (Micro DVD format only)",
".txt (Micro DVD format only)"

Playable Codec format: "DIV3", "MP43", "DIVX",
"XVID", "DX50"

Playable Audio format: "AC3", "PCM", "MP2",
"MP3", "WMA"

- Sampling frequency:
within 8 - 48 kHz (MP3), within 32 - 48kHz (WMA)
- Bit rate:
within 8 - 320kbps (MP3), 32 - 192kbps (WMA)

CD-R Format: ISO 9660 and JOLIET.

DVD±R/RW Format: ISO 9660 (UDF Bridge format)

Maximum Files/Disc: Less than 1999 (total number of files and folders)

Notes on DivX format

- If the number of the screen frame is over 29.97 frames per second, this unit may not operate normally.
- If the video and audio structure of recorded file is not interleaved, returns to the menu screen.
- If the file is recorded with GMC, the unit supports only 1-point of the record level.
- GMC?

GMC is the acronym for Global Motion Compensation. It is an encoding tool specified in MPEG4 standard. Some MPEG4 encoders, like DivX or Xvid, have this option.

There are different levels of GMC encoding, usually called 1-point, 2-point, or 3-point GMC.

Playing an Audio CD or MP3/WMA file

The recorder can play audio CDs and MP3/WMA files. Before playing MP3/WMA files, read "MP3/WMA audio file requirement" on right.

1. Press HOME.
The HOME menu appears.
2. Select [Music] option.
3. Select a media that contains MP3/WMA or audio title then press ENTER.
The [Music List] menu appears on the TV screen.

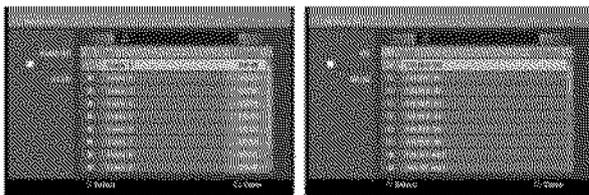

4. Use ▲/▼ to select a track then press PLAY (▶).
Playback starts.
You can use variable playback functions. Refer to pages 25-28.

Tips:

- Press DISPLAY to view ID3-Tag information for the MP3 file. If ID3-Tag information is not present, [ID3-Tag: None] will appear. If you select a folder, the number of subfolders and number of MP3/WMA files in the folder are displayed. Press DISPLAY again to remove the information screen.
- If you want to move to the upper directory, use the ▲ / ▼ to highlight [..] and press ENTER.

5. To stop playback at any time, press STOP.

Audio CD and Music List menu options

1. Press ▲ / ▼ to select a folder/file on the [Music List] menu then press ENTER.
The menu options appear.
The menu options displayed differ depending on the selected media.
2. Press ▲ / ▼ / ◀ / ▶ to select an option, and press ENTER.
 - [Play] Start playback the selected title.
 - [Random] Start or stop random playback.
 - [Open] Opens the folder and a list of files in the folder appears
 - [Delete] Deletes the selected file(s)/folder(s) from the memory card. (page 32)

Random

1. Press ▲ / ▼ to select a file then press ENTER.
The menu options appear.
2. Press ▲ / ▼ to select [Random] option then press ENTER.
The unit automatically begins random playback and "RANDOM" appears on the menu screen.
3. To return to normal playback, select [Random] option again then press ENTER.

Tip:

By pressing SKIP ►► during Random playback, the unit selects another track and resumes Random playback.

MP3/WMA audio file requirement

File extensions

"mp3", ".wma"

Sampling frequency:

within 8 - 48 kHz (MP3), within 32 - 48kHz (WMA)

Bit rate:

within 8 - 320kbps (MP3), within 32 - 192kbps (WMA)

CD-R Format:

ISO 9660 and JOLIET.

DVD±R/RW Format:

ISO 9660 (UDF Bridge format)

Maximum Files/Disc:

Less than 1999 (total number of files and folders)

Viewing a JPEG File

The recorder can play JPEG files. Before playing JPEG recordings, read "Photo file requirement" on right.

1. Press HOME.
The HOME menu appears.
2. Select [Photo] option.
3. Select a media that contains JPEG file then press ENTER.
The [Photo List] menu appears on the TV screen.

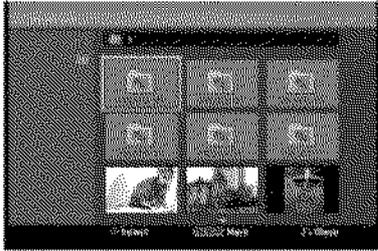

4. Use ◀ / ▶ / ▲ / ▼ to select a file, then press ENTER.
The menu options appear on the left side of the menu.

Tips:

- If you want to move to the upper directory, use the ▲ / ▼ to highlight [Up] and press ENTER.
- You can select all files on the menu by pressing CLEAR button. To cancel the selections, press CLEAR again.

Selecting multiple files

1. Press MARKER.
A check mark appears on the file. Press MARKER again to cancel the marked file.
 2. Repeat step 1 to mark additional file.
5. Use ▲ / ▼ to select [Full Screen] then press ENTER.
The selected image is displayed in full screen. Depending upon the size and number of JPEG files, it could take a long time for the recorder to read the files.

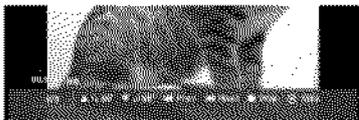

Press ENTER to appear or disappear this menu during viewing the full screen.

6. To stop viewing at any time, press STOP.
The [Photo List] menu appears.

Tip:

If you press RETURN (↵) while menu screen is displaying, the screen is changed to TV viewing or AV input.

Photo List menu options

1. Press ▲ / ▼ to select a file on the [Photo List] menu then press ENTER.
The menu options appear.
The menu options displayed differ depending on the selected media.
2. Use ▲ / ▼ to select an option then press ENTER to confirm your selection.
 - [Open] Opens the folder and a list of files in the folder appears
 - [Full Screen] Shows the selected file as full screen.
 - [Slide Show] Displays Slide Show menu.
 - [Delete] Deletes the selected file(s)/folder(s) from the memory card. (page 32)
 - [Copy] Copies the file(s) from a disc to a memory card. (page 32)

Skip Images

While viewing a picture, press SKIP (◀◀ or ▶▶) once to advance to the next file or return to the previous file.

Rotate Images

Use ▲ / ▼ while viewing a picture to flip the picture clockwise or counterclockwise.

Photo file requirement

File extensions

“.jpg”

Photo size:

Less than 4MB recommended

CD-R Format:

ISO 9660 and JOLIET.

DVD±R/RW Format:

ISO 9660 (UDF Bridge format)

Maximum Files/Disc:

Less than 1999 (total number of files and folders)

Notes on JPEG file

Progressive and lossless compression JPEG image files are not supported.

View Slide Shows

1. Select [Slide Show] option on the [Photo List] menu (Refer to "Photo List menu options" on page 31).
2. Press ENTER.
The Slide Show menu appears.

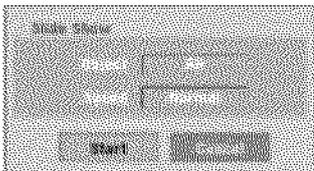

3. Use ◀ / ▶ / ▲ / ▼ to set the options.
[Object] option:
 - [Selected] Views slide show only selected files.
Use the MARKER button to select multiple files.
 - [All] Views slide show all files.[Speed] option:
Sets the Slide Show speed to [Slow], [Normal], or [Fast].
4. Select the [Start] option then press ENTER to start the Slide Show.
The slide show continues until you press STOP.
5. Press STOP to stop the Slide Show and returns to the Photo List menu.

To Pause the Slide Show

1. Press PAUSE/STEP (⏸) to pause slide show.
2. When you want to continue slide show, press PLAY (▶).

Erasing a JPEG file(s)/folder(s) from the memory card

1. Select a file you wish to erase then press ENTER on the menu.
The menu options appear on the menu.

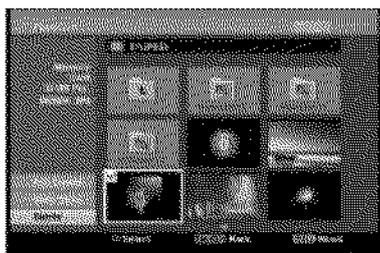

2. Select [Delete] option then press ENTER.
The confirm message for deleting will appear.
3. Use ◀ / ▶ to select [Yes] then press ENTER.
The selected file(s) is deleted.

Copying a JPEG file(s) from a disc to a memory card

1. Select a file you wish to copy on the menu.
2. Press ENTER.
The menu options appear on the menu.
3. Select [Copy] option then press ENTER.
Copy menu appears.

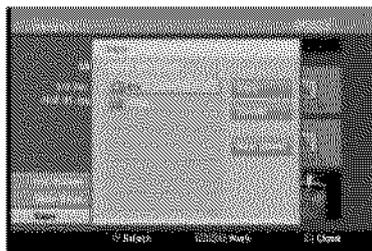

4. Select a memory card slot 1 or 2, if required.
5. You can select a album (folder) to copy.
 1. After selecting a media then press ENTER.
The album (folder) list appears.
 2. Select a folder.
Also, you can create new album (folder). Select [New Album] option on the Copy menu then press ENTER.
"NONAME##" folder is created.
6. Select [Copy] option then press ENTER to begin copying.

Tip to select a file(s)

You can select all files on the menu by pressing CLEAR button. To cancel the selections, press CLEAR again.

Selecting multiple files

1. Press MARKER.
A check mark appears on the file. Press MARKER again to cancel the marked file.
2. Repeat step 1 to mark additional file.

Recording

About DVD recording

Notes:

- This recorder cannot make recordings on CD-R or CD-RW discs.
- Our company takes no responsibility for recording failure due to power outages, defective discs, or damage to the Recorder.
- Fingerprints and small scratches on a disc can affect playback and/or recording performance. Please take proper care of your discs.

Disc types and recording formats, modes, and settings

This recorder can play five different kinds of DVD discs: pre-recorded DVD-Video discs, DVD-RW, DVD-R, DVD-RAM, DVD+RW and DVD+R discs. The disc format for DVD-R, DVD+R, DVD+RW discs is always "Video format"—the same as pre-recorded DVD-Video discs. This means that once finalized, you can play a DVD-R, DVD+R, or DVD+RW in a regular DVD player. The DVD-RAM disc format is Video Recording (VR) format.

By default, the DVD-RW disc format is Video format, though you can change this to Video Recording (VR) format, if required. (Reinitializing the disc will erase the contents of the disc.)

The recording mode is closely related to the disc format. If the disc format is Video Recording format, then the recording mode is VR mode; if the disc format is Video mode, then the recording mode is Video mode (except for DVD-Video, which is not recordable, and so does not have a recording mode). Within the recording modes (which are fixed for them whole disc) are the record settings. These can be changed as required for each recording and determine the picture quality and how much space the recording will take up on the disc.

Notes for recording

- The recording times shown are not exact because the recorder uses variable bit-rate video compression. This means that the exact recording time will depend on the material being recorded.
- When recording a TV broadcast, if the reception is poor or the picture contains interference, the recording times may be shorter.
- If you record still pictures or audio only, the recording time may be longer.
- The displayed times for recording and time remaining may not always add up to exactly the length of the disc.
- The recording time available may decrease if you heavily edit a disc.
- If using a DVD-RW disc, make sure you change the recording format (Video mode or VR mode) before you record anything on the disc. See page 22 (Initialize) for how to do this.
- When using a DVD-R or DVD+R disc, you can keep recording until the disc is full, or until you finalize the disc. Before you start a recording session, check the amount of recording time left on the disc.
- When using a DVD-RW disc in Video mode, recording time available will only increase if you erase the last title recorded on the disc.
- The Delete Title option in the Title List (Original) menu only hides the title, it does not actually erase the title from the disc and increase the recording time available (except for the last recorded title on a DVD-RW disc in Video mode).
- Overwrite recording is available using DVD+RW discs.
- When using a DVD+R/RW, the recorder will execute the Menu-making operation to update the new title and editing when removing the disc from the recorder or turn off the recorder.

Recording time and picture quality

There are four preset recording quality modes:

- **XP** – Highest quality setting, gives about 1 hour of recording time on a DVD (4.7GB).
- **SP** – Default quality, sufficient for most applications, gives about 2 hours of recording time on a DVD (4.7GB).
- **LP** – Slightly lower video quality, gives about 4 hour of recording time on a DVD disc (4.7GB).
- **EP** – Lowest video quality, gives about 6 hour of recording time on a DVD (4.7GB).

You may see a fragmented picture during playing back the contents recorded in EP mode .

Restrictions on copying

Some video material is copy-once protected: If you want to record copy-once protected material to DVD, you must use a VR mode DVD-RW disc compatible with CPRM Ver. 1.1.

You can identify copy-once protected material during playback by displaying disc information on-screen.

- PAL format signals from the analog or the DV inputs is not recorded correctly with this recorder.
- Video that is 'copy-once only' can only be recorded using DVD-RW disc in VR mode or DVD-RAM disc with CPRM (see below).

What is 'CPRM'?

CPRM is a copy protection system (with scramble system) only allowing the recording of 'copy once' broadcast programs. CPRM stands for Content Protection for Recordable Media.

This Recorder is CPRM compatible, which means that you can record copy-once broadcast programs, but you cannot then make a copy of those recordings. CPRM recordings can only be made on DVD-RW discs formatted in VR mode or DVD-RAM discs, and CPRM recordings can only be played on players that are specifically compatible with CPRM.

Copyright

- Recording equipment should be used only for lawful copying and you are advised to check carefully what is lawful copying in the area in which you are making a copy. Copying of copyright material such as films or music is unlawful unless permitted by a legal exception or consented to by the rights owner.
- This product incorporates copyright protection technology that is protected by method claims of certain U.S. patents and other intellectual property rights owned by Macrovision Corporation and other rights owners. Use of this copyright protection technology must be authorized by Macrovision Corporation, and is intended for home and other limited viewing uses only, unless otherwise authorized by Macrovision corporation. Reverse engineering or disassembly is prohibited.
- CONSUMERS SHOULD NOTE THAT NOT ALL HIGH DEFINITION TELEVISION SETS ARE FULLY COMPATIBLE WITH THIS PRODUCT AND MAY CAUSE ARTIFACTS TO BE DISPLAYED IN THE PICTURE. IN CASE OF 525 PROGRESSIVE SCAN PICTURE PROBLEMS, IT IS RECOMMENDED THAT THE USER SWITCH THE CONNECTION TO THE 'STANDARD DEFINITION' OUTPUT. IF THERE ARE QUESTIONS REGARDING OUR TV SET COMPATIBILITY WITH THIS MODEL 525p DVD RECORDER, PLEASE CONTACT OUR CUSTOMER SERVICE CENTER.

Basic Recording from a TV

Follow the instructions below to record a TV program. Recording starts immediately and continues until the disc is full or you stop the recording.

Note:

You must load a recordable disc for DVD recording.

1. Set a recording mode as necessary by pressing REC MODE repeatedly. (XP, SP, LP, EP)
2. Use CH (+/-) buttons to select the TV channel to record.
3. Use AUDIO to select the audio channel to record. The table below shows what will be recorded on the different settings for different types of broadcast. The last column (Monitor Audio) shows what you'll hear as it is recording.

TV Broadcast	Selected Audio	Broadcast Audio		Monitor Audio
		L Ch	R Ch	
MONO	MONO	MONO	MONO	MONO
STEREO	STEREO	L	R	STEREO
	Left	L	L	Left
	Right	R	R	Right
	MONO	MONO	MONO	MONO
MONO+SAP	MONO	MONO	MONO	MONO
	SAP	SAP	SAP	SAP
STEREO +SAP	STEREO	L	R	STEREO
	SAP	SAP	SAP	SAP
	MONO	MONO	MONO	MONO

If you set the audio channel to SAP, but there is no SAP channel being broadcast, the main audio (mono or stereo) will be recorded.

4. Press REC (●) once. Recording will start. (The REC indicator lights in the display window.)
 - Recording continues until you press STOP (■) or the disc is full.
 - To record for a fixed length of time, see Instant Timer Recording on right.
5. Press STOP (■) to stop recording.

To Pause the Recording

1. Press PAUSE/STEP (||) to pause recording.
2. When you want to continue recording, press PAUSE/STEP (||).

To record one TV program while watching another

1. Press TV/DVD to select the TV mode during recording. The TV indicator appears.
2. Using the TV, select the channel to be viewed.

Instant Timer Recording

Instant Timer Recording allows you to make a recording easily of a preset length without using the program timer.

1. Follow steps 1-2 as shown left (Basic Recording from a TV).
2. Press REC (●) repeatedly to select the recording time length.



Recording starts after the first press.

Each subsequent press increases the recording time within free space.

The recording time is displayed on the TV screen. At the end of the recording, the recorder will stop recording and shut off.

Checking the Recording Time

Press REC (●) once to check the recording time. The recalled setting will automatically return to the TV screen for a moment.

Also, remaining time of recording is shown in the display window.

To Extend the Recording Time

The recording time can be extended anytime by pressing REC (●).

Each subsequent press increases the recording time within free space.

Caution

If the recorder is unplugged (or there is a power failure) while the recorder is recording, the recording will be lost.

Playing while you are recording **RAM**

You can start play from the beginning of the title while continuing to record it.

1. Press PLAY (▶) while recording. Start play of the title you are recording.
2. Press STOP (■) to return to the current recording screen.

or

1. Press TIMESHIFT while recording. The PIP(Picture-In-Picture) window appears on the screen. What is currently being recorded appears as a PIP and you will hear the playback audio. You can change the main and sub picture by pressing TIMESHIFT.
2. Press STOP (■) to return to the current recording screen.

Notes:

- Play cannot be started until at least 30 seconds after recording starts.
- This function is not available during timer recording.

Timer Recording

This recorder can be programmed to record up to 16 programs within a period of 1 month. For unattended recording, the timer needs to know the channels to be recorded, the starting and ending time.

Note:

If you use a completely blank disc for timer recording, you must format the disc before starting timer recording. (Refer to "Initialize" on page 22.)

1. Press HOME and select [TV] option.
2. Press ▲ / ▼ to select [Timer Record] option then press ENTER.
The [Timer Record List] will appear.
3. Press ▲ / ▼ to select [New] option then press ENTER.
The [Timer Record] menu will appear.

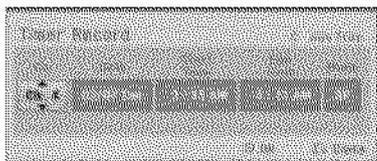

- [Ch.] Choose a memorized channel number, or one of the external inputs from which to record. (You cannot select DV input.)
- [Date] Choose a date up to 1 month in advance or desired repeat (Monday ~ Friday, or Every Sun~Sat).
- [Start Time] Set the start time.
- [End Time] Set the end time.
- [Mode] Choose a recording mode as necessary. (XP, SP, LP, EP, or AT)
AT (Auto) mode determines how much disc time is available and switches record mode, if necessary, to complete recording the program.

4. Enter the necessary information for your timer recording(s).
 - ◀ / ▶ (left/right) – move the cursor left/right
 - ▲ / ▼ (up/down) – change the setting at the current cursor position
 - Press RETURN (↵) to return to the [Timer Record] list.
5. Press ENTER, the program will be memorized by the recorder.
To check the programming, the [Timer Record] list will appear.
[Check] field's [Rec. OK] on the [Timer Record] list indicates that the timer recording is programmed correctly.
6. Press RETURN (↵) to exit the [Timer Record] list.
7. Make sure that you load a recordable disc for DVD recording and press POWER to switch your unit to Standby.

Notes:

- The timer indicator lights in the display window when the recorder is in standby with the timer active. (Nothing is displayed while the [Power Save Mode] is ON.)
- You must press POWER to stop the timer recording.

Checking Timer Recording Details

Programming can be checked whenever the recorder is turned on.

1. Press HOME and select [TV] option.
 2. Press ▲ / ▼ to select [Timer Record] option then press ENTER.
The [Timer Record List] will appear.
- Use ▲ / ▼ to select a timer recording.
 - Press ENTER to edit the selected program. Timer Record menu appears.
 - Press CLEAR to delete the selected program from the Timer Record List.

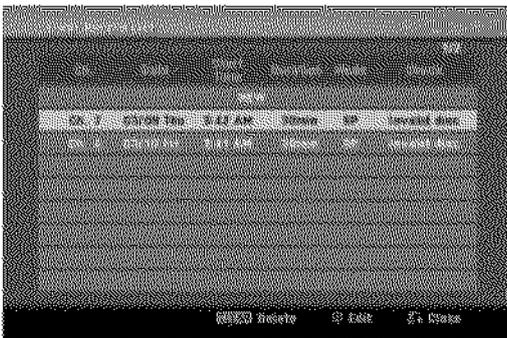

Canceling a Timer Recording

You can clear a timer setting anytime before the recording actually starts.

- Use ▲ / ▼ to select a program you want to erase on the Timer Recorder List. If you want to erase the program, press CLEAR.

Stopping a Timer Recording in Progress

After a timer recording has started, you can still cancel the program.

- Press POWER.

Timer Recording Troubleshooting

Even though the timer is set, the recorder will not record when:

- There is no disc loaded.
- A non-recordable disc is loaded.
- [Disc Protect] option is set to [ON] in the Setup menu. (see page 23).
- Power is turned on.
- There are already 99 titles (DVD-RW, DVD-R, DVD-RAM), 49 titles (DVD+R, DVD+RW) recorded on the disc.

You cannot enter a timer program when:

- A recording is already underway.
- The time you're trying to set has already passed.
- There are already 16 timer programs set.

If two or more timer programs overlap:

- The earlier program takes priority.
- When the earlier program finishes, the later program starts.
- If two programs are set to start at exactly the same time, the program entered first takes priority.

If the disc is damaged, the recording may not complete successfully. In this case even though the Check field shows "Rec. OK", it may not be.

Recording from an External Input

Recording from External Components

You can record from an external component, such as a camcorder or VCR, connected to any of the recorder's external inputs.

1. Make sure that the component you want to record from is connected properly to the recorder. See page 16.
2. Press INPUT repeatedly to select the external input to record from.
 - Tuner: Built-in tuner
 - AV1: AV IN 1 (AUDIO IN 1 / VIDEO IN 1) mounted on back panel
 - AV2: AV IN 2 (VIDEO, AUDIO (L/R), S-VIDEO IN) mounted on front panel
 - DV: DV IN mounted on front panel
3. Select the recording mode as necessary by pressing REC MODE repeatedly. (XP, SP, LP, or EP)
4. Press REC (●) once.
Recording will start. (The REC indicator lights in the display window.)
 - Recording continues until you press STOP (■) or the disc is full.
 - To record for a fixed length of time, see "Instant Timer Recording" on page 35.

5. Press STOP (■) to stop recording.

Note:

If your source is copy-protected using CopyGuard, you will not be able to record it using this recorder. See Copyright on page 34 for more details.

Recording from DV Input

Before DV dubbing

You can connect a DV-equipped camcorder to this recorder using a single DV cable for input and output of audio, video, data and control signals.

- This recorder is only compatible with DV-format (DVC-SD, DV25) camcorders. Digital satellite tuners and Digital VHS video recorders are not compatible.
- You cannot connect more than one DV camcorder at a time to this recorder.
- You cannot control this recorder from external equipment connected via the DV IN jack (including two recorders).
- It may not always be possible to control the connected camcorder via the DV IN jack.
- Digital camcorders can usually record audio as stereo 16-bit/48kHz, or twin stereo tracks of 12-bit/32kHz. This recorder can only record one stereo audio track. Set [DV Rec Audio] option to [Audio 1] or [Audio 2] as required (see page 22).
- Audio input to the DV IN jack should be 32 or 48kHz (not 44.1kHz).
- Picture disturbance on the recording may occur if the source component pauses playback or plays an unrecorded section of tape, or if the power fails in the source component, or the DV cable becomes disconnected.

Recording from a Digital Camcorder

You can record from a digital camcorder connected to the DV IN jack on the front panel of this recorder.

Using the recorder's remote, you can control both the camcorder and this recorder.

Before recording, make sure that the audio input for the DV IN jack is set up (see page 22).

Tips:

- The source signal must be DVC-SD format.
- Some camcorders cannot be controlled using this recorder's remote.
- If you connect a second recorder using a DV cable, you cannot control the second DVD from this one.
- You cannot control this unit remotely from a component connected to the DV IN jack.
- You cannot record date and time information from a DV cassette.

1. Make sure your digital camcorder is connected to the front panel DV IN jack. See page 16.
2. Check that the DV audio input is as you require. You can choose between Audio 1 (original audio) and Audio 2 (overdubbed audio).
 - DV Input is set from the [DV Rec Audio] in sub-menu of the Setup menu. See "DV Recording Audio" on page 22 for more information.
3. Press INPUT repeatedly to select the DV input. DV appears in the display window and on the TV screen.
4. Find the place on the camcorder tape that you want to the recording to start from. For best results, pause playback at the point from which you want to record.
 - Depending on your camcorder, you can use this recorder's remote to control the camcorder using the STOP, PLAY and PAUSE functions.
5. Press REC (●) once to start recording.
 - Recording is automatically stopped if the recorder detects no signal.
 - You can pause or stop the recording by pressing PAUSE/STEP (■) or STOP (■). You cannot control the camcorder from this remote control during recording.
 - In Video mode, the final frame of the recording may remain displayed on screen for a while after recording stops.

Troubleshooting

If you cannot get a picture and/or audio through the DV IN jack, check the bullet points:

- Make sure the DV cable is properly connected.
- Try switching off the connected equipment then switch back on.
- Try switching the audio input.

Note:

Depending on the connected camcorder, you may not be able to control it using the remote control supplied with this recorder.

Editing

Title List and Chapter List Menu Overview

Using the Title List menu you can edit video content. The editing features available in the Title List menu depend on whether you are editing video on DVD, and whether you're editing Original content, or a Playlist.

There are two ways to edit VR mode DVD-RW discs. You can directly edit the Original content of the disc, or you can create and edit a Playlist. The Playlist doesn't actually change any of the content on the disc, but just controls how the content is played back.

1. Press MENU/LIST to display the Title List menu. Playback should be stopped when you do this.
 - You can also access it using HOME menu, select [Movie] option then select [DISC] option and press ENTER.
 - When selecting titles, use the ▲ / ▼ buttons to display the previous/next page if there are more than six titles.
 - If you are editing a VR mode disc, press MENU/LIST to switch between Original and Playlist menu.

On the left side of the screen are the menu options. The main part of the screen shows thumbnails of the titles (or chapter) on the DVD. You can change these thumbnails using the THUMBNAIL button—see Changing Title Thumbnails on page 40.

Press DISPLAY to display the information of selected title on the Title List menu.

After selecting a title or chapter on the Title List or Chapter List menu, then press ENTER. The menu options appears on the left side of the menu.

Use ▲ / ▼ to select a option then press ENTER to confirm your selection.

2. To exit the Title List menu, press RETURN (↵) repeatedly.

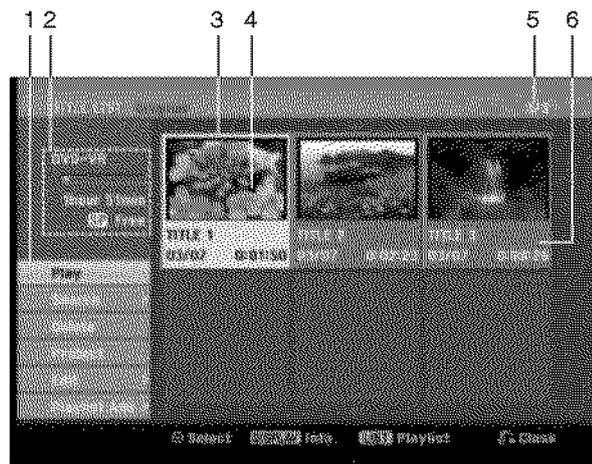

1. Menu options: To display menu option, select a title or chapter then press ENTER. The options displayed differ depending on the disc type.
 - [Combine] Combines two chapters into one (page 44).
 - [Delete] Deletes the title or chapter. (page 42)
 - [Delete Part] Deletes a part of the Title (page 42).
 - [Divide] Divides a title into two (page 44).
 - [Full Play] Starts playback of the selected title including the hidden chapters.
 - [Hide (Show)] Hides (or Shows) the selected title or chapter. (page 45)
 - [Move] Moves a chapter on the Chapter List-Playlist menu to a position on the menu. (page 45)
 - [Play] Start playback of the selected title or chapter. The hidden titles and chapters on the DVD+R/RW cannot be play back.
 - [Playlist Add] Adds the title or chapter to the Playlist. (page 41)
 - [Protect] Protects accidental recording, editing or deleting of the title. (page 45)
 - [Title Name] Edits the title name. (page 43)
 - [Search]
 - [Chapter]; Displays Chapter List of the Title.
 - [Time]; Search time for you want start point of the title. (page 43)
 - [Title] Displays Title List of the chapter.
2. Indicates the disc name, record mode, free space, and elapsed time progress bar.
3. Currently selected title.
4. Thumbnail
5. Shows the selected title number and total number of titles.
6. Shows the title name, recorded date, and recording length.

VR Mode: Original and Playlist Editing

Titles, Chapters and Parts

Titles in the disc's original content contain one or more chapters. When you insert a disc's title into the Playlist, all the chapters within that title also appear. In other words, chapters in the Playlist behave exactly as chapters on a DVD-Video disc do. Parts are sections of Original or Playlist titles. From the Original and Playlist menu you can add or delete parts. Adding a chapter or title to the Playlist creates a new title made up of a section (ie., chapter) of an Original title. Deleting a part removes part of a title from the Original or Playlist menu.

Caution

- When editing using the Delete, Add and Move functions, the start and end frames may not be exactly as set in the start and end point display.
- During Playlist playback, you may notice a momentary pause between edits. This is not a malfunction.

Is editing a DVD like editing a video tape?

No. When you edit a video tape you need one video deck to play the original tape and another to record the edits. With DVD, you edit by making a 'Playlist' of what to play and when to play it. On playback, the Recorder plays the disc according to the Playlist.

About word 'Original' and 'Playlist'

-RW_{VR} RAM

Throughout this manual, you will often see the words Original and Playlist to refer to the actual content and the edited version.

- **Original:** content refers to what's actually recorded on the disc.
- **Playlist:** content refers to the edited version of the disc — how the Original content is to be played.

Adding Chapter Markers

Chapter

-RW_{VR} RAM +RW +R

You can create chapters within a title by inserting chapter marks at the desired points.

Note:

Chapter markers are inserted at regular intervals automatically. You can change this interval from the Initial Setup menu (see "Auto Chapter" on page 22).

During recording or playing back, at the point you want to start a new chapter, press **CHP ADD**. A chapter marker icon appears on the TV screen.

Changing Title Thumbnails

Thumbnail

-RW_{VR} RAM +RW +R

Each title displayed in the Title List menu is represented by a thumbnail picture taken from the start of that title or chapter.

If you prefer, select a different still picture from within a title.

Press **THUMBNAIL** to make the currently displayed picture the one that appears in the Title List menu.

The still picture that you choose appears in both the Original or Playlist menu.

Tip:

You can also change the thumbnail picture of the title on the Chapter List menu. Select a chapter on the Chapter List menu then press **THUMBNAIL**. The thumbnail picture of the title that includes the chapter is changed.

Making a New Playlist

-RWVR **RAM**

Use this function to add an Original title or chapter to the Playlist. When you do this, the whole title is put into the Playlist (you can delete bits you don't need later — see Deleting an Original or Playlist title/chapter on page 42).

The title appears in the Playlist complete with the chapter markers that appear in the Original. However, if you add more chapter markers to the Original later, these are not automatically copied over into the Playlist title.

You can add up to 999 chapters to one disc. If you only want to add a chapter of a title, use the Adding a title/chapter to the Playlist on this page.

1. Choose a title or chapter on the Title List-Original menu or Chapter List-Original menu to put into the Playlist, then press ENTER. The menu options appears on the left side of the menu.

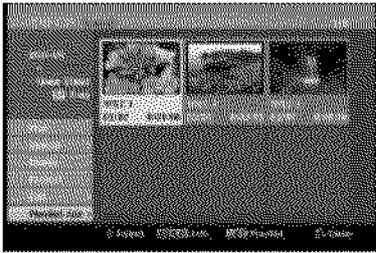

2. Use ▲ / ▼ to select [Playlist Add] option then press ENTER.

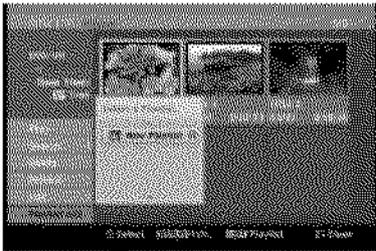

3. Select [New Playlist] then press ENTER. The new title appears in the updated Playlist. All chapters of the title are added to the Playlist.

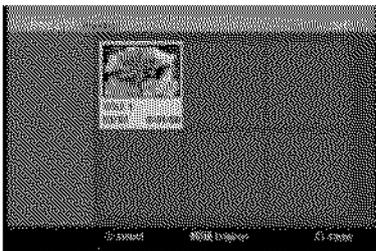

Adding Additional Title/Chapters to the Playlist

-RWVR **RAM**

You can add an Original title or chapter to add to a Playlist title even if it is already registered.

1. Choose a title or chapter on the Title List-Original menu or Chapter List-Original menu to put into the Playlist, then press ENTER. The menu options appears on the left side of the screen.

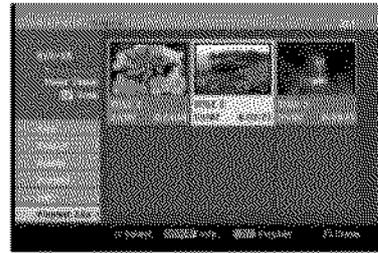

2. Use ▲ / ▼ to select [Playlist Add] from menu options then press ENTER.

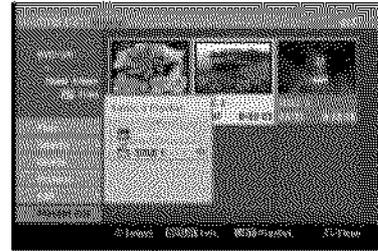

3. Choose a Title List-Playlist that is already registered to insert a title or chapter, then press ENTER.
4. Repeat steps 1-3 to add additional title or chapter on the Playlist. You can view the added chapters on the Chapter List-Playlist menu.

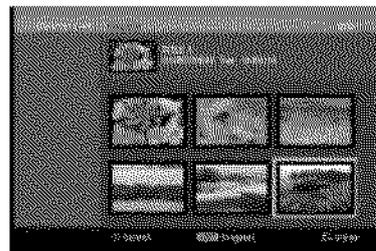

5. Press RETURN (↵) to exit, or MENU/LIST to go back to the Title List-Original menu.

Deleting an Original or Playlist Title/Chapter

When you erase a title or chapter from the Playlist menu, you only remove it from the Playlist; the title/chapter remains in the Original menu.

If you choose to delete a title or chapter from the Original (title/chapter) menu, the title or chapter is actually deleted from the disc and the remaining time available for recording increases. Titles/chapters deleted from the Original are also removed from the Playlist.

Note:

It may not be possible to delete chapters that are less than 5 seconds long.

1. Use ◀ / ▶ / ▲ / ▼ to choose a chapter or title you want to delete on the Title List or Chapter List menu then press ENTER. The menu options appears on the left side of the screen.
2. Select [Delete] option from the options on the menu.

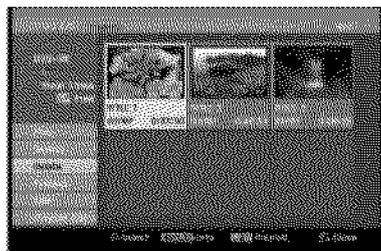

3. Press ENTER to confirm. The confirm message for deleting will appear.
4. Use ◀ / ▶ to select [Yes] then press ENTER. The selected chapter or title is deleted. After pressing ENTER, the new, updated menu is displayed.
5. Repeat steps 1 - 4 to continue to delete from the menu.
6. Press RETURN (↵) repeatedly to exit the menu.

Notes:

- When DVD+RW recording, the deleted title's name is changed to 'Deleted Title'.
- If more than two titles are repeatedly deleted, the titles are combined into one.
- When you are deleting a title or chapter, only the last one on DVD+RW increases remaining recording time.

Deleting a Part -RWvR RAM

You can delete a part which you do not want in the title.

1. Use ◀ / ▶ / ▲ / ▼ to choose a title you want to delete on the Title List menu then press ENTER. The options appears on the left side of the menu.
2. Select [Delete Part] option then press ENTER. Edit (Delete Part) menu appears on the TV screen. [Start Point] icon is highlighted.

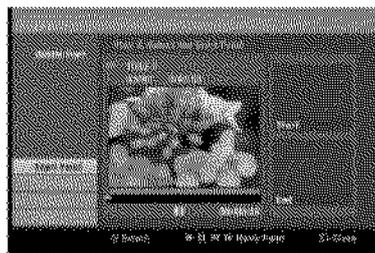

3. Starts playback and use pause step, search and slow-motion to find the starting point.
4. Press ENTER at the starting point of the section you want to delete. 'End Point' icon is highlighted. The part is indicated on the Progress Bar.
5. Use pause step, search and slow-motion to find the ending point.
6. Press ENTER at the ending point of the section you want to delete. You can cancel the selected point, use ▲ / ▼ to select [Cancel] icon then press ENTER.
7. If you finish to edit, select [Done] icon then press ENTER. The confirm message for deleting will appear. Use ◀ / ▶ to select [Yes] then press ENTER. The selected part is deleted from the title and Title List menu appears.

Note:

It may not be possible to delete parts that are less than 3 seconds long.

Naming a Title

You can name Original and Playlist titles independently. Names can be up to 32 characters long.

1. Choose the title you want to name on the Title List menu, then press ENTER. The menu options appears on the left side of the menu.
2. Use ▲/▼ to select [Title Name] option then press ENTER. Keyboard menu appears.

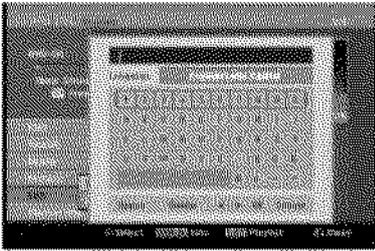

3. Enter a name for the title. Use ◀/▶/▲/▼ to select a character then press ENTER to confirm your selection.
 - Use MENU/LIST button to change keyboard type.
 - OK: Select to finish.
 - Cancel: Cancels all entered characters.
 - Space: Inserts a space at the cursor position.
 - Delete: Deletes the previous character at the cursor position.
 - ◀/▶: Moves cursor to left or right.

Tip:

Remote control buttons for entering a name

PLAY (▶): Inserts a space at the cursor position.

II (PAUSE/STEP): Deletes the after character at the cursor position.

■ (STOP), CLEAR: Deletes the previous character at the cursor position.

◀◀ / ▶▶: Moves cursor to left or right.

Numbers (0-9): Enters the corresponding character at the cursor position.

4. Choose OK then press ENTER to fix the name and return to the previous menu screen.
5. Press RETURN (↵) repeatedly to exit the menu.

Notes:

- Names can be up to 32 characters long.
- For discs formatted on a different recorder, you will see only a limited character set.
- When recording on DVD-R, DVD+R or DVD+RW discs, the entered name is displayed on the DVD player only after finalization.

Time Search

-RWVR **-RWVideo** **RAM** **+RW** **-R** **+R**

You can select start point of the title.

1. Use ◀/▶/▲/▼ to choose a title on the Title List menu then press ENTER. The options appears on the left side of the menu.
2. Select [Time] option then press ENTER. [Search] menu appears on the TV screen.

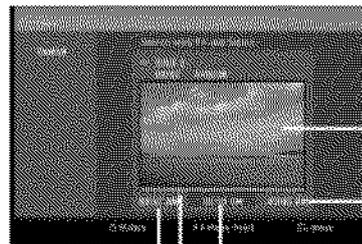
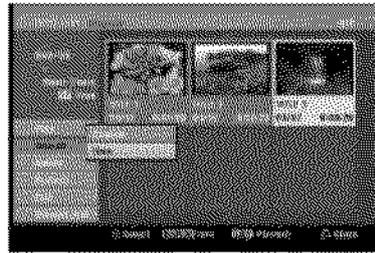

Start time Selected time
Selected point
Current picture
End time

3. Use ◀/▶ to find the point you want to start. The point increase 1 minute step. If you press and hold ◀/▶ then the point increase 5 minute step.
4. Press ENTER to start selected point.

Divide One Titles Into Two

+RW

Use this command to split a title up into two new titles.

1. On the Title List menu, select a title you want to divide then press ENTER.
The menu options appears on the left side of the screen.
2. Select [Divide] option.

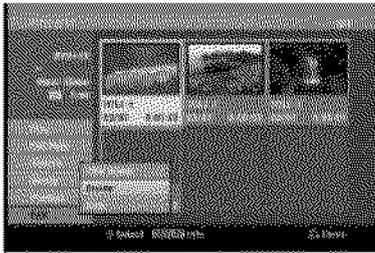

3. Press ENTER.
Edit (Divide) menu appears. [Divide] option is highlighted.

Current picture

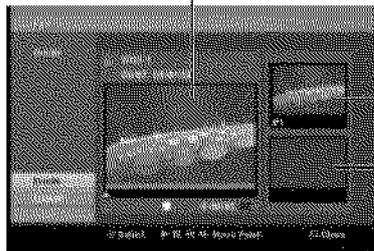

The first title's thumbnail

The second title's thumbnail

4. Use play, pause step, search and slow-motion to find the point you want to divide the title.
5. Select [Divide] option then press ENTER at the point.
To reset the point, select [Cancel] option then press ENTER. Repeat from step 3.
6. Choose [Done] option then press ENTER to fix the dividing point.
The title is divided into two new titles. It take up to 4 minutes to divide.

Note:

You cannot select dividing point less than 3 seconds.

Combining Two Chapters Into One

-RWvR +RW +R RAM

Use this function to combine two adjacent Playlist or Original chapters into one.

Note:

This function is not available if there is only one chapter within the title.

1. On the Chapter List menu, select the second chapter of the two chapters you want to combine then press ENTER.
The menu options appears on the left side of the screen.
2. Use ▲ / ▼ to select [Combine] option.
The combine indicator appears between the two chapters you want to combine.

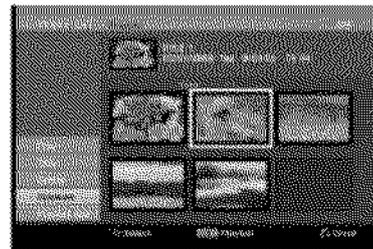

3. Press ENTER.

Moving a Playlist Chapter

-RWVR **RAM**

Use this function to re-arrange the playing order of Playlist chapters on the Title List-Playlist menu.

Note:

This function is not available if there is only one chapter.

1. Select a chapter on the Chapter List-Playlist menu.
2. Press ENTER.
The menu options appears on the left side of the menu.
3. Use ▲ / ▼ to select [Move] option from Playlist options then press ENTER.

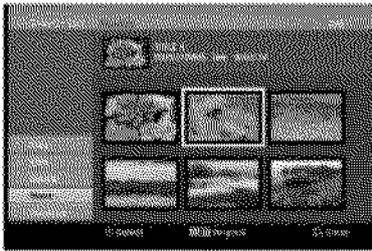

4. Use ◀ / ▶ / ▲ / ▼ to choose the place you want to move the chapter to then press ENTER.
After pressing ENTER, the updated menu is displayed.

Hide a Chapter/Title **+RW** **+R**

You can skip playing chapters or titles without deleting from the disc.

1. Use ▲ ▼ ◀ ▶ to choose a chapter or title you want to hide on the Title List or Chapter List menu, then press ENTER.
Options appear on the left side of the screen.

2. Select [Hide] option.

Example: Title List (DVD+RW)



3. Press ENTER to confirm.
The chapter's or title's thumbnail will dim.

Tip

If you select a hidden chapter or title on the Title List or Chapter List menu, you can 'show' it by choosing [Show] option on the menu. After doing that, you are able to see the chapter or title.

Protect a Title

+RW **+R** **-RWVR** **RAM**

Use this function to protect against accidental recording, editing or deleting of the title.

1. Press MENU/LIST to display the Title List menu.
2. Use ▲ ▼ ◀ ▶ to choose a title you want to protect then press ENTER.
Options appear on the left side of the screen.
3. Select [Protect] from the options.



4. Press ENTER to confirm.
The lock mark will appears on the title's thumbnail.

Tip

If you select a title that has already been protected on the Title List menu, you can 'unprotect' it by choosing [Protect] option from the Title List menu options. After doing that, you can edit and delete the title.

Reference

Additional Information

Overwriting Recording **+RW**

To overwrite a new video recording on a previously recorded title, follow these steps. This feature is not available for DVD+Rs, that always record at the end of the Disc.

1. Select input source you want to record (TV channel, AV1-2, DV).
2. Press MENU/LIST to display the Title List menu.

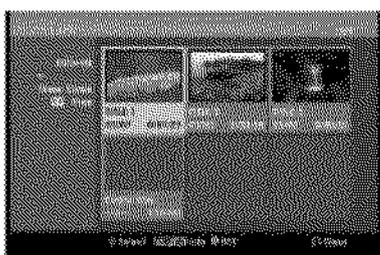

3. Use ▲▼◀▶ to choose a title you want to overwrite.
4. Press REC (●) to start overwrite recording. Overwrite recording starts from the start point of the title.
5. Press STOP (■) to stop the overwrite recording. The new title is created and updated menu is displayed.

Notes:

- This function is not available for a protected title.
- If the overwrite is longer than the recording length of the current title, the next title is overwritten. But if next title is protected, the overwriting stops at the starting point of the title.
- If the selected title's recording length is less than 10 seconds, the next title is overwritten. But if the next title is protected, overwriting stops.

Viewing Title List menu displayed on other DVD Recorders or Players

+RW **+R**

You can view the Title List menu displayed on the other DVD player that is capable of playing DVD+RW or DVD+R discs.

1. Insert DVD+R or DVD+RW disc recorded already.

2. Press TITLE in play or stop mode. Title List menu will appear as shown below.

Tip

You can remove the Title List menu by pressing STOP (■).

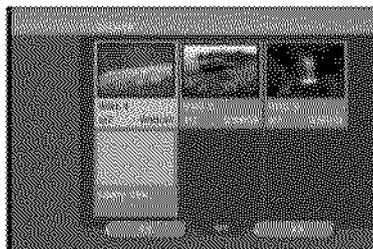

3. To play back a title, select the title you want then press ENTER or PLAY (▶).

Playing Your Recordings on Other DVD Players (Finalizing a Disc)

Most regular DVD players can play finalized discs recorded in Video mode, finalized DVD+R or DVD+RWs. A small number of players can also play DVD-RW discs recorded in VR mode, finalized or not. Check the manual that came with the other player to check what formats of discs it will play.

Finalizing 'fixes' the recordings and editings in place so that the disc can be played on a regular DVD player or computer equipped with a suitable DVD-ROM drive. Finalizing a Video mode disc creates a menu screen for navigating the disc. The menu can be accessed by pressing MENU/LIST or TITLE.

To finalize a disc, refer to "Finalize" on page 23.

Notes:

- Unfinalized DVD+RW is playable on regular DVD players.
- The edited contents of a DVD+RW disc is compatible on regular DVD players only after finalization.
- Any edited contents of the DVD+R disc are not compatible on regular DVD players. (Hide, chapter combine, added chapter mark, etc.)
- How long finalization takes depends on the type of disc, how much is recorded on the disc, and the number of titles on the disc.
- DVD+R DL disc can take up to 30 minutes to finalize.

Language Codes

Use this list to input your desired language for the following initial settings:
Disc Audio, Disc Subtitle, Disc Menu.

Language	Code	Language	Code	Language	Code	Language	Code
Abkhazian	6566	Fiji	7074	Lingala	7678	Singhalese	8373
Afar	6565	Finnish	7073	Lithuanian	7684	Slovak	8375
Afrikaans	6570	French	7082	Macedonian	7775	Slovenian	8376
Albanian	8381	Frisian	7089	Malagasy	7771	Somali	8379
Ameharic	6577	Galician	7176	Malay	7783	Spanish	6983
Arabic	6582	Georgian	7565	Malayalam	7776	Sudanese	8385
Armenian	7289	German	6869	Maltese	7784	Swahili	8387
Assamese	6583	Greek	6976	Maori	7773	Swedish	8386
Aymara	6588	Greenlandic	7576	Marathi	7782	Tagalog	8476
Azerbaijani	6590	Guarani	7178	Moldavian	7779	Tajik	8471
Bashkir	6665	Gujarati	7185	Mongolian	7778	Tamil	8465
Basque	6985	Hausa	7265	Nauru	7865	Tatar	8484
Bengali; Bangla	6678	Hebrew	7387	Nepali	7869	Telugu	8469
Bhutani	6890	Hindi	7273	Norwegian	7879	Thai	8472
Bihari	6672	Hungarian	7285	Oriya	7982	Tibetan	6679
Breton	6682	Icelandic	7383	Panjabi	8065	Tigrinya	8473
Bulgarian	6671	Indonesian	7378	Pashto, Pushto	8083	Tonga	8479
Burmese	7789	Interlingua	7365	Persian	7065	Turkish	8482
Byelorussian	6669	Irish	7165	Polish	8076	Turkmen	8475
Cambodian	7577	Italian	7384	Portuguese	8084	Twi	8487
Catalan	6765	Japanese	7465	Quechua	8185	Ukrainian	8575
Chinese	9072	Javanese	7487	Rhaeto-Romance	8277	Urdu	8582
Corsican	6779	Kannada	7578	Rumanian	8279	Uzbek	8590
Croatian	7282	Kashmiri	7583	Russian	8285	Vietnamese	8673
Czech	6783	Kazakh	7575	Samoan	8377	Volapük	8679
Danish	6865	Kirghiz	7589	Sanskrit	8365	Welsh	6789
Dutch	7876	Korean	7579	Scots Gaelic	7168	Wolof	8779
English	6978	Kurdish	7585	Serbian	8382	Xhosa	8872
Esperanto	6979	Laothian	7679	Serbo-Croatian	8372	Yiddish	7473
Estonian	6984	Latin	7665	Shona	8378	Yoruba	8979
Faroese	7079	Latvian, Lettish	7686	Sindhi	8368	Zulu	9085

Area Codes

Choose an area code from this list.

Area	Code	Area	Code	Area	Code	Area	Code
Afghanistan	AF	Ethiopia	ET	Malaysia	MY	Saudi Arabia	SA
Argentina	AR	Fiji	FJ	Maldives	MV	Senegal	SN
Australia	AU	Finland	FI	Mexico	MX	Singapore	SG
Austria	AT	France	FR	Monaco	MC	Slovak Republic	SK
Belgium	BE	Germany	DE	Mongolia	MN	Slovenia	SI
Bhutan	BT	Great Britain	GB	Morocco	MA	South Africa	ZA
Bolivia	BO	Greece	GR	Nepal	NP	South Korea	KR
Brazil	BR	Greenland	GL	Netherlands	NL	Spain	ES
Cambodia	KH	Islands	HM	Netherlands Antilles	AN	Sri Lanka	LK
Canada	CA	Hungary	HU	New Zealand	NZ	Sweden	SE
Chile	CL	India	IN	Nigeria	NG	Switzerland	CH
China	CN	Indonesia	ID	Norway	NO	Thailand	TH
Colombia	CO	Israel	IL	Oman	OM	Turkey	TR
Congo	CG	Italy	IT	Pakistan	PK	Uganda	UG
Costa Rica	CR	Jamaica	JM	Panama	PA	Ukraine	UA
Croatia	HR	Japan	JP	Paraguay	PY	United States	US
Czech Republic	CZ	Kenya	KE	Philippines	PH	Uruguay	UY
Denmark	DK	Kuwait	KW	Poland	PL	Uzbekistan	UZ
Ecuador	EC	Libya	LY	Portugal	PT	Vietnam	VN
Egypt	EG	Luxembourg	LU	Romania	RO	Zimbabwe	ZW
El Salvador	SV			Russian Federation	RU		

Reference

Controlling Your TV with the Supplied Universal Remote Control

You can control the sound level, input source, and power switch of your LG TV with the supplied Universal Remote Control.

You can control your TV using the buttons below.

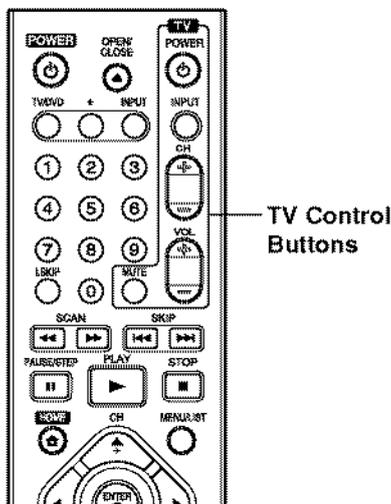

By pressing	You can
POWER	Turn the TV on or off.
INPUT	Switch the TV's input source between the TV and other input sources.
CH +/-	Scans up or down through memorized channels.
VOL +/-	Adjust the volume of the TV.
MUTE	Temporarily turns TV sound OFF, press again to restore.

Note:

Depending on the unit being connected, you may not be able to control your TV using some of the buttons.

Controlling other TVs with the Universal Remote Control

You can control the sound level, input source, and power switch of non-LG TVs as well. If your TV is listed in the table below, set the appropriate manufacturer code.

1. While holding down TV POWER button, press the number buttons to select the manufacturer code for your TV (Refer to table on the right column).
2. Release TV POWER button.

Code numbers of controllable TVs

If more than one code number is listed, try entering them one at a time until you find the one that works with your TV.

Manufacturer	Code Number	Manufacturer	Code Number
ADMIRAL	16, 33, 37, 44, 45	MONTGOMERY	01, 06, 08, 09
AIWA	70	WARD	23, 24, 30, 33, 34
AKAI	01	NEC	01, 08, 36
AMARK	08	NOBLEX	07
AOC	01	PACKARD BELL	43
BELL & HOWELL	33	PANASONIC	07, 11, 13, 23, 38, 39
BROKSONIC	18, 19	PHILCO	01, 06, 07, 08, 09
CANDLE	51		13, 38, 43, 58
CCE	07	PHILIPS	06, 07, 43, 61, 62, 65
CENTURION	08	PIONEER	30
CINERAL	09		09
CITIZEN	49, 50, 51, 52, 53, 54, 55	PROSCAN	03, 37, 44
CORONADO	09	QUASAR	11, 13
CROWN	09	RADIO SHACK	16, 17, 23
CURTIS MATHEIS	01, 03, 08, 33, 35, 37, 44	RCA	01, 03, 37, 44, 69
DAEWOO	16, 38, 39, 40, 41, 42, 43	REALISTIC	16, 17, 23
DAYTRON	01, 08	SAMPO	08
EMERSON	01, 08, 16, 17, 18, 19	SAMSUNG	01, 08, 09, 23, 68
FISHER	28, 29	SANYO	28, 29
FUNAI	46, 47	SCOTT	01, 08
GENERAL ELECTRIC	08, 10, 11, 13, 37, 44	SEARS	08, 23, 28, 27, 28, 29
GRADIENTE	01, 36, 37, 63, 67	SEMP	64
HITACHI	08, 14, 15, 43	SHARP	08, 23, 23, 24, 60, 66
JC PENNEY	01, 08, 10, 27, 36	SIGNATURE 2000	01, 06, 08, 09, 10
JVC	20, 21, 63, 67		23, 24, 33, 34
KIOTE	43	SONY	12, 62, 93
KMC	09	SOUNDDESIGN	51
KTV	01, 08, 09, 31	SYLVANIA	01, 04, 05, 06, 07
LG (GOLDSTAR)	01, 07, 08, 09, 35, 39, 40		08, 35, 51
LODGENET	33	SYMPHONIC	46, 47
LOGIK	33	TATUNG	11
LXI	08, 24, 25, 26, 27, 28, 29	TEKNIKA	07, 09, 18, 33, 51
MAGNAVOX	01, 02, 04, 05, 06, 07, 08, 09, 20, 34, 35, 43, 31, 61, 62, 65	TELERENT	06, 33
		THOMSON	88
		YORX	08
MAJESTIC	33	TOSHIBA	01, 23, 28, 27, 64
MARANTZ	01, 32	WARDS	01, 06, 08, 09, 10, 33, 34
MEMOREX	33	XRT1000	48
MGA-MITSUBISHI	01, 08, 32, 34	ZENITH	01, 02, 33, 59

Notes:

- Depending on your TV, some or all buttons may not function on the TV, even after entering the correct manufacturer code.
- If you enter a new code number, the code number previously entered will be erased.
- When you replace the batteries of the remote, the code number you have set may be reset to the default setting. Set the appropriate code number again.

Troubleshooting

Check the following guide for the possible cause of a problem before contacting service.

Symptom	Cause	Solution
No power.	<ul style="list-style-type: none"> The power cord is disconnected. 	<ul style="list-style-type: none"> Plug the power cord into the wall outlet securely.
No picture.	<ul style="list-style-type: none"> The TV is not set to receive recorder signal output. 	<ul style="list-style-type: none"> Select the appropriate video input mode on the TV so the picture from the recorder appears on the TV screen.
	<ul style="list-style-type: none"> The video cable is not connected securely. 	<ul style="list-style-type: none"> Connect the video cable securely.
	<ul style="list-style-type: none"> The connected TV power is turned off. 	<ul style="list-style-type: none"> Turn on the TV.
No sound.	<ul style="list-style-type: none"> The equipment connected with the audio cable is not set to receive recorder signal output. 	<ul style="list-style-type: none"> Select the correct input mode on the audio receiver so you can listen to the sound from the recorder.
	<ul style="list-style-type: none"> The audio cables are not connected securely. 	<ul style="list-style-type: none"> Connect the audio cable securely.
	<ul style="list-style-type: none"> The power of the equipment connected with the audio cable is turned off. 	<ul style="list-style-type: none"> Turn on the equipment connected with the audio cable.
	<ul style="list-style-type: none"> The audio connecting cord is damaged. 	<ul style="list-style-type: none"> Replace it with new one.
The playback picture is poor.	<ul style="list-style-type: none"> The disc is dirty. 	<ul style="list-style-type: none"> Clean the disc.
The recorder does not start playback.	<ul style="list-style-type: none"> No disc is inserted. 	<ul style="list-style-type: none"> Insert a disc. (Check that the disc indicator in the display window is lit.)
	<ul style="list-style-type: none"> An unplayable disc is inserted. 	<ul style="list-style-type: none"> Insert a playable disc. (Check the disc type, color system, and regional code.)
	<ul style="list-style-type: none"> The disc is placed upside down. 	<ul style="list-style-type: none"> Place the disc with the playback side down.
	<ul style="list-style-type: none"> The disc is not placed within the guide. 	<ul style="list-style-type: none"> Place the disc on the disc tray correctly inside the guide.
	<ul style="list-style-type: none"> The disc is dirty. 	<ul style="list-style-type: none"> Clean the disc.
	<ul style="list-style-type: none"> The Rating level is set. 	<ul style="list-style-type: none"> Cancel the Rating function or change the rating level.
The picture from the external input is distorted	<ul style="list-style-type: none"> The video signal from the external component is copy-protected. 	<ul style="list-style-type: none"> You cannot connect via this recorder. Connect the component directly to your TV.
Some channels are skipped over when using CH (+/-).	<ul style="list-style-type: none"> Those channels are not stored in the recorder. 	<ul style="list-style-type: none"> Use the CH, Add/Del feature to restore channels. See [To Add or Erase Channels] on page 18.
The picture or sound of broadcasting channel is weak or missing.	<ul style="list-style-type: none"> Antenna or cables are loose. 	<ul style="list-style-type: none"> Tighten connections or replace cable.
Camcorder image is not shown.	<ul style="list-style-type: none"> Camcorder is off. 	<ul style="list-style-type: none"> Turn camcorder on and operate properly.
Camcorder image via A/V input or DV IN to recorder is not shown on TV screen.	<ul style="list-style-type: none"> The recorder's source is incorrect. 	<ul style="list-style-type: none"> Use INPUT to select input channel (AV1, AV2, DV, etc.)

Symptom	Cause	Solution
Cannot play a disc recorded using this recorder on another player.	• The disc was recorded in Video mode.	• Finalize the disc. (page 23)
	• Some players will not play even a finalized disc recorded in Video mode.	• No solution.
	• The disc was recorded in VR mode,	• The other player must be RW compatible in order to play it.
	• Discs recorded with copy-once material cannot be played on other players.	• No solution.
Cannot record or did not record successfully.	• The remaining blank space on the disc is insufficient.	• Use another disc.
	• The source you are trying to record is copy protected.	• You cannot record the source.
	• When setting the recording channel, the channel is tuned on the TV's own tuner.	• Select the channel on the recorder's built-in TV tuner.
	• When recording to a Video mode disc, programs that are copy-once protected cannot be recorded.	• Use a VR mode formatted disc for copy-once material.
Timer recording is not possible.	• Clock in recorder is not set to correct time.	• Set clock to correct time. See "Auto Clock Set" or "Manual Clock Set" on page 19.
	• Timer has been programmed incorrectly.	• Reprogram Timer. See "Timer Recording" on page 36.
	• Timer record indicator light does not appear after programming timer.	• Reprogram Timer.
Stereo Audio Record and/or Playback is not present.	• TV is not Stereo-compatible.	• No solution.
	• Broadcast program is not in stereo format.	• No solution.
	• The recorder A/V Out jacks are not connected to TV A/V In jacks.	• Make A/V connections. Stereo is available only via A/V output from the recorder.
	• The recorder Audio/Video Out is not selected for viewing at the TV.	• Select AUX or A/V source as TV input.
	• The recorder's TV audio channel is set to mono.	• Set TV audio channel mode to Stereo. See page 35.
The remote control does not work properly.	• The remote control is not pointed at the remote sensor of the recorder.	• Point the remote control at the remote sensor of the recorder.
	• The remote control is too far from the recorder.	• Operate the remote control within 7 m.
	• There is an obstacle in the path of the remote control and the recorder.	• Remove the obstacle.
	• The batteries in the remote control are exhausted.	• Replace the batteries with new ones.

Resetting the recorder

If you observe any of the following symptoms...

- The unit is plugged in, but the power will not turn on or off.
- The front panel display is not working.
- The recorder is not operating normally.

...you can reset the recorder as follows:

- Press and hold the POWER button for at least five seconds. This will force the unit to power off then turn the unit back on.
- Unplug the power cord, wait at least five seconds, and then plug it in again.

Specifications

General

Power requirements	AC 120 V, 60 Hz
Power consumption	22W
Dimensions (approx.)	430 X 54 X 275 mm (w x h x d) without foot
Mass (approx.)	4.1 kg
Operating temperature	5°C to 35°C
Operating humidity	5 % to 90 %
Television system	NTSC color system
Recording format	NTSC

Recording

Recording format	DVD Video Recording, DVD-VIDEO
Recordable media	DVD-ReWritable, DVD-Recordable, DVD+ReWritable, DVD+Recordable, DVD+Recordable (Double Layer), DVD-RAM
Recordable time	DVD (4.7GB): Approx. 1 hour (XP mode), 2 hours (SP mode), 4 hours (LP mode), 6 hours (EP mode) DVD+R DL (8.5GB): Approx. 2 hour (XP mode), 3 hours 40 minutes (SP mode), 7 hours 10 minutes (LP mode), 11 hours (EP mode)

Video recording format

Sampling frequency	27MHz
Compression format	MPEG 2 (VBR support)

Audio recording format

Sampling frequency	48kHz
Compression format	Dolby Digital

Playback

Frequency response	DVD (PCM 48 kHz): 8 Hz to 22 kHz, CD: 8 Hz to 20 kHz DVD (PCM 96 kHz): 8 Hz to 44 kHz
Signal-to-noise ratio	More than 100 dB (AUDIO OUT connector)
Harmonic distortion	Less than 0.008% (AUDIO OUT connector)
Dynamic range	More than 95 dB (AUDIO OUT connector)

Inputs

ANTENNA IN	Antenna input, 75 ohms
VIDEO IN	1.0 Vp-p 75 ohms, sync negative, RCA jack x 2
AUDIO IN	2.0 Vrms more than 47 kohms, RCA jack (L, R) x 2
S-VIDEO IN	(Y) 1.0 V (p-p), 75 Ω, sync negative, Mini DIN 4-pin x 1 (C) 0.286 V (p-p) 75 Ω
DV IN	4 pin (IEEE 1394 standard)

Outputs

VIDEO OUT	1 Vp-p 75 Ω, sync negative, RCA jack x 1
S-VIDEO OUT	(Y) 1.0 V (p-p), 75 Ω, sync negative, Mini DIN 4-pin x 1 (C) 0.286 V (p-p) 75 Ω
COMPONENT VIDEO OUT	(Y) 1.0 V (p-p), 75 Ω, sync negative, RCA jack x 1 (Pb)/(Pr) 0.7 V (p-p), 75 Ω, RCA jack x 2
HDMI video/audio output	19 pin (HDMI standard, Type A)
Audio output (digital audio)	0.5 V (p-p), 75 Ω, RCA jack x 1
Audio output (optical audio)	3 V (p-p), Optical connector x 1
Audio output (analog audio)	2.0 Vrms (1 KHz, 0 dB), 600 Ω, RCA jack (L, R) x 1

Accessory:

Video cable	1	Audio cable (L, R)	1
RF Coaxial Cable	1	Remote control	1
Batteries	2		

- Design and specifications are subject to change without notice.



**LG Electronics, Inc.
Limited Warranty - USA**

This LG Electronics product, will be repaired or replaced, at LG's option, if it proves to be defective in material or workmanship, under normal use, during the warranty period ("Warranty Period") listed below, effective from the date ("Date of Purchase") of original consumer purchase of the product. This warranty is good only to the original purchaser of the product and effective only when used in the United States, excluding U.S. Territories.

WARRANTY PERIOD: LABOR: 90 days from the Date of Purchase. PARTS: One Year from the Date of Purchase. * Parts replaced are warranted for the remaining portion of the original warranty period.	HOW SERVICE IS HANDLED: Call 1-800-243-0000 for instructions on getting the defective unit repaired or replaced. Please retain dated sales receipt and your box to return the unit to LG for repair or replacement. Shipping both ways will be paid by LG during the Warranty Period. After the Warranty Period, you pay inbound shipping charges and LG pays return shipping charges. Visit our website at: http://www.lgservice.com
---	---

THIS WARRANTY IS IN LIEU OF ANY OTHER WARRANTIES, EXPRESS OR IMPLIED, INCLUDING WITHOUT LIMITATION, ANY WARRANTY OF MERCHANTABILITY OR FITNESS FOR A PARTICULAR PURPOSE. TO THE EXTENT ANY IMPLIED WARRANTY IS REQUIRED BY LAW, IT IS LIMITED IN DURATION TO THE EXPRESS WARRANTY PERIOD ABOVE. LG ELECTRONICS WILL NOT BE LIABLE FOR ANY INCIDENTAL, CONSEQUENTIAL, INDIRECT, SPECIAL OR PUNITIVE DAMAGES OF ANY NATURE, EVEN IF ADVISED OF THE POSSIBILITY OF SUCH DAMAGES, INCLUDING WITHOUT LIMITATION, LOST REVENUES OR PROFITS, LOST OR CORRUPTED PROGRAMMING OR DATA, OR ANY OTHER DAMAGE WHETHER BASED IN CONTRACT, TORT OR OTHERWISE. Some states do not allow the exclusion or limitation of incidental or consequential damages or limitation on how long an implied warranty lasts, so the above exclusion or limitation may not apply to you. This warranty gives you specific legal rights and you may also have other rights that may vary from state to state.

THIS LIMITED WARRANTY DOES NOT APPLY TO:

- Damages or operating problems that result from shipping, installation, adjustment of user controls, calibration, maintenance or failure to maintain, or separate system components; and
- Damages or operating problems that result from normal wear and tear, misuse, abuse, operation outside environmental specifications or contrary to the requirements or precautions in the Operating Guide, accident, lightning strikes or other natural causes, unauthorized modification or alteration, incorrect electrical current or voltage, reception problem caused by inadequate home antenna or faulty antenna connections, computer software, institutional or commercial use, or other causes not arising out of defect in material or workmanship.

Therefore, the cost of repair or replacement of such defective product shall be borne by the consumer.

CUSTOMER INTER-ACTIVE CENTER NUMBERS:

For nearest Authorized Service Center, Where to buy, Product Assistance, or Customer Assistance	Call 1-800-243-0000 (24 hours a day, 365 days per year) and select appropriate options from the menu. Or visit our website at http://www.lgservice.com
--	---