

Specifications

EV960H (ASIA)

		65
DISPLAY	Type	OLED (Wallpaper)
	Resolution	3,840 x 2,160 (4K UHD)
	Brightness	400cd/m ²
	Viewing Angle Degree	178° / 178°
	Response Time	5
BROADCASTING SYSTEM	Analog	PAL / SECAM
	Digital	DVB-T2/C/S2 (Varied by Countries)
VIDEO	Picture Engine	XD Engine
	Real Cinema 24p (3:3 Pull down)	•
	Aspect Ratio	• 6 modes (16:9, Original, Full wide, 4:3, Vertical Zoom, All-Direction Zoom)
	HDR	Dolby Vision™, HDR10
AUDIO	Audio Output / Speaker System	30W + 30W / 4.2ch
	Sound Mode	• 6 modes (Standard, Cinema, Clear Voice III, Sports, Music, Game)
	Clear Voice	• (Clear Voice III)
SOLUTIONS	Type	Pro:Centric® Smart, V, Direct
	Data Streaming (IP & RF)	•
	RF	• (1 Tuner)
	HCAP (SDK)	GEM / Flash /HTML5
	Pro:Centric Application	PCA 3.7
	DRM	Pro:Idiom®
SMART FEATURES	Smart UX	webOS 3.5, Commercial Smart Home, Web Browser, Pre-loaded Apps, SDP (Service Delivery Platform) compatibility, Magic Remote Ready
	Connectivity	SoftAP, WiFi (ac), ScreenShare (Miracast), SmartShare, DIAL, Bluetooth Sound Sync, LG Sound Sync
HOSPITALITY FEATURES	Hotel Mode, Lock Mode, Welcome Screen, Insert Image, One Channel Map, External Speaker Out, Instant ON, RJP Compatibility, External Power	
GENERAL FEATURES	Installation	EzManager, USB Cloning
	Management	Wake on RF, WOL, Remote Diagnostics, TVLink Interactive, IR Out, Multi IR Code, HTNG/HDMI-CEC
	Setting Option	Auto Off/Sleep Timer, Smart Energy Saving, Motion Eye Care
	Anti-theft System	Kensington Lock (AIO Box)
INTERFACE	Rear	RF In (2), AV In (Phone Jack Type), Video Component In (Phone Jack Type), Digital Audio Out (Optical), HDMI Input (2), USB (2), RS-232C (Control & Service), RJ45 (2), External Speaker Out (2)
DIMENSION (Unit : mm)	W x H x D / weight (Screen)	1,450 x 825 x 3.85 / 7.6kg*
	W x H x D / weight (AIO)	1,260 x 78 x 198 / 10kg
	W x H x D / weight (Packing)	1,641 x 952 x 288 / 33kg
POWER (Unit : Watts)	Voltage, Hz	100-240V, 50/60Hz
	Max	542
	Typical	481
	Energy Saving (Min)	336
	Energy Saving (Med)	230
	Energy Saving (Max)	138
Stand-by	0.5 ↓	
STANDARD APPROVAL	Safety	Varied by Countries
	Environment	Varied by Countries
	Etc.	Varied by Countries

*Weight of Wall Mount is not included.

Pro:Centric® SMART

EV960H (ASIA)

OLED Wallpaper Hotel TV With Premier IP-based Solution

Marvel at the aesthetics of the world's first OLED Wallpaper Hotel TV, which blends perfectly into the wall. The EV960H series features an impossibly light and thin "Picture-on-Wall" design and supports premier hotel solutions with the guest in mind, using LG's innovative OLED technology. Plus, with outstanding picture quality and HDR (high dynamic range) compatibility, it gives guests theater-like experience.



EV960H

- NEW Picture-on-Wall Design
- NEW Dolby Vision™ HDR, HDR10
- OLED Technology– Intense Colors, Infinite Contrast, Perfect Viewing Screen
- Pro:Centric® SMART
- Pro:Idiom®
- Pro:Centric® Direct Ready

screen size

65"

OLED Wallpaper Hotel TV

Picture-on-Wall Design

Slim as a blade

The thin, artistic design of the EV960H series blends perfectly into the wall without even the trace of a shadow.



Dolby Vision™ HDR

Active HDR

Dolby Vision™ is a technology that delivers intense highlights, vivid colors and deep black on the screen. LG OLED TV supports premium HDR contents mastered by Dolby Vision™ and is even compatible with generic HDR10.

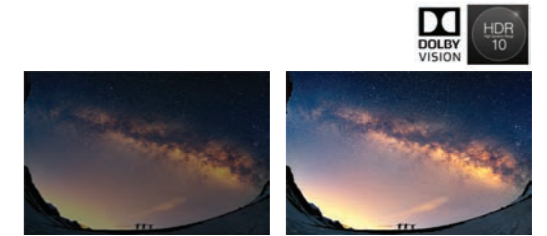

OLED Technology

Intense Colors

Vibrant picture quality

OLED hospitality TVs bring colors to life with superb accuracy. Self-lighting pixels give the TV expanded color scope, delivering finest details of color and gradation. This allows guests to enjoy content more vividly.

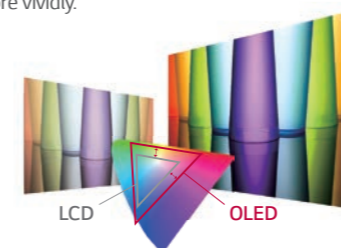

Infinite Contrast

Limitless contrast and deepest black

Self-lighting pixels switch off completely to create a deep black. No light bleed. Absolute black offers infinite contrast, and guests can appreciate its clarity.

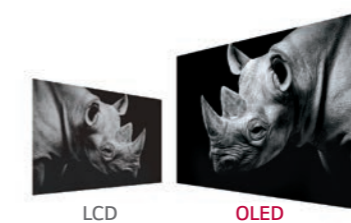

Perfect Viewing Screen

Wide viewing angle

LG OLED Commercial TVs delivers awe-inspiring picture quality across the entire screen, even from wide viewing angles.



Download LG Commercial Display Mobile App



Learn more www.lg.com/b2b

YouTube youtube.com/c/LGCommercialDisplay

All screen images are simulated. Dimension and weights are approximate. Design, features and specifications subject to change without notice. © Copyright 2017 LG Electronics Inc. All Rights Reserved. Pro:Centric, the "LG" logo, XD Engine are registered trademarks or trademarks of LG Electronics Inc. Pro:Idiom is a registered trademark of Zenith Electronics LLC. All other trademarks or registered trademarks are the property of their respective owners.



OLED Wallpaper Hotel TV With Premier IP-based Solution

Pro:Centric® Smart EV960H

Pro:Centric® SMART

ASIA

Pro:Centric Smart is an elaborate and smart mode of control and customization for commercial televisions. With the customizable tools including HTML5, Java, and Flash, users can optimize the commercial TVs according to their purposes with IP-based programs. This expansion of control provides premium hotel services to guests without the need for a set-top box. Additionally, as the Pro:Centric Smart models are compatible with Pro:Centric Server Application, you can remotely manage TVs in a centralized coaxial infrastructure you already have.

Pro:Centric Smart Application Platform

LG Pro:Centric SMART offers extended customizable tools; HTML5, Java and Flash. With these, the partners can optimize Commercial TVs to edit and develop their own enhanced service design. Also, it gives visual impact on and delivers messages to customers as users intend.

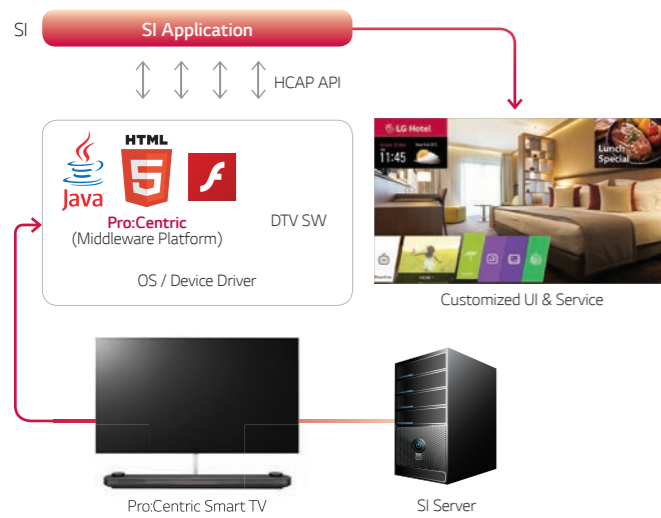

Pro:Centric Direct Ready

Simply create your own templates and remotely manage TVs on the IP network with Pro:Centric Direct, LG's content management software. Pro:Centric Direct offers a free design template, along with customizable widgets and three types of theme templates (Cinematic-type, Grid-type, Bar-type) in order to promote branding and meet guests' tastes and needs. Its interactive solution, including 1-click service, and intuitive UI impress guests while elevating their hotel experience. Plus, for hoteliers, not only does it offer efficient content production and management, but it also maximizes advertisement effectiveness, which contributes to improving the hotel brand.

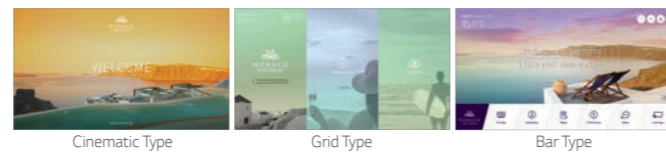

Smart Connectivity

SmartShare
SmartShare allows users to share content more easily and quickly. It also searches for the content they want in order to share it more easily and accurately, thereby simplifying the process of sharing between various devices.

Bluetooth Sound Sync (Bluetooth 3.0)
Bluetooth Sound Sync enables users to listen to music on a mobile device through TV speakers via Bluetooth connection.

*Support devices for Bluetooth Sound Sync :
Android (above v4.4 KitKat) / iOS based Mobile Device

ScreenShare
Connect a smartphone or a laptop PC to TV via a Wi-Fi Direct connection. The TV will display the device's screen, and users can share their content and memories together.

LG Sound Sync
Through a wireless connection, guests can listen the sounds of the LG Smart hospitality TVs using Bluetooth devices such as Bluetooth Speaker and headset. It helps guests to have their own spaces without disturbing other guests.

Pro:Centric Server Application

You can now differentiate your hotel with our customizable templates and pages which can be specialized for your property. Pro:Centric® provides you a solution that is easily customizable for your business.

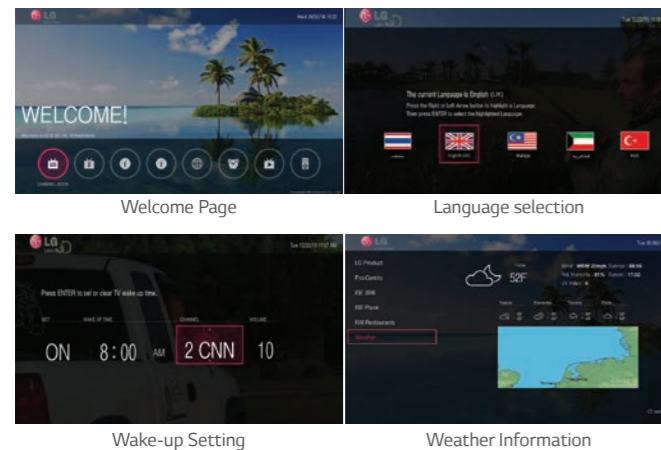

• Various Features

PCA serves the convenience of the guest through a Wake-up setting, Weather Information, Map Service, and much more functions that you can choose.

• Customizable Template & Page

Choose an alternative look & feel template based on your reference, and edit multiple sections with 40 pages of billboards by yourself with the web based tool.

Images of Various Angles



Dimensions (Unit : mm / kg)

65"

Head : 1,450 x 825 x 3.85 / 7.6kg*

AIO (All In One) BOX : 1,260 x 78 x 198 / 10kg

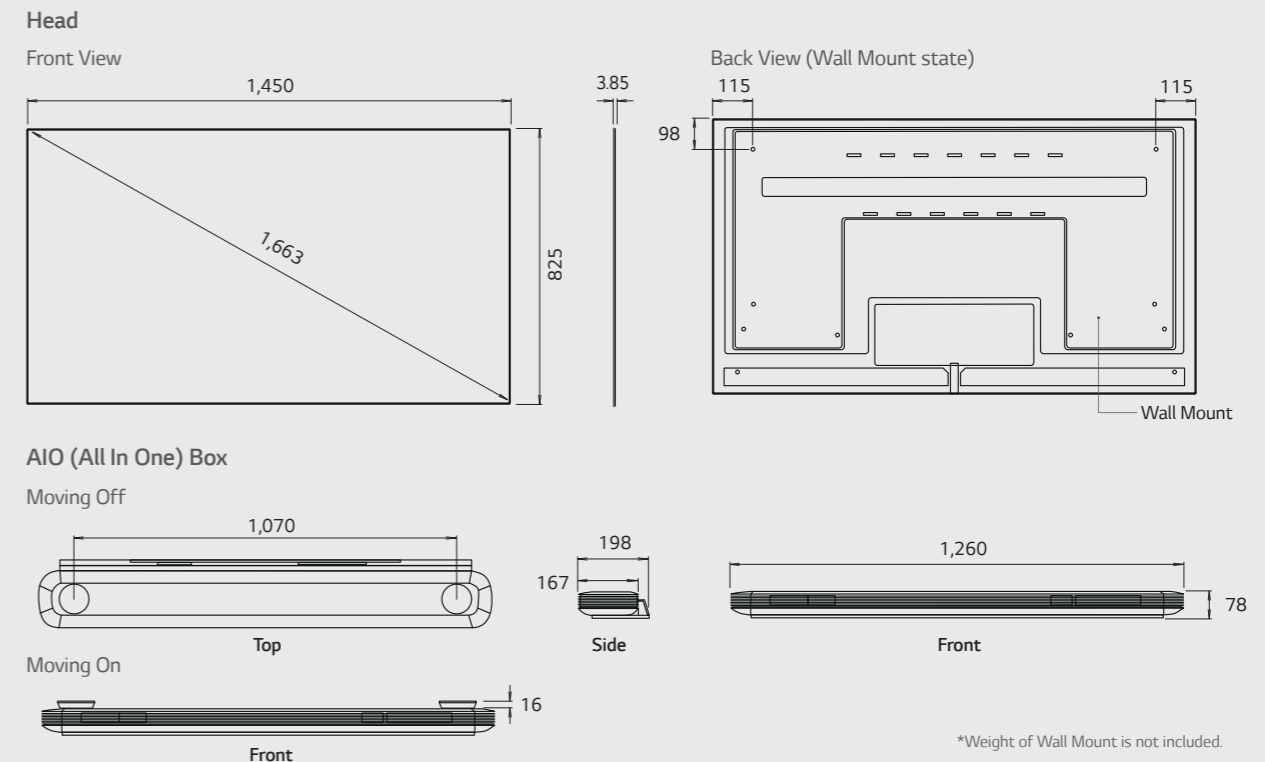

*Weight of Wall Mount is not included.

Connectivity

- 1 AV
- 4 AUX LAN
- 7 ANTENNA / CABLE IN
- 10 USB IN 1
- 2 COMPONENT
- 5 LAN
- 8 USB IN 2
- 11 RS-232C IN
- 3 OPTICAL DIGITAL AUDIO OUT
- 6 LNB Satellite IN
- 9 HDMI IN
- 12 STEREO 8Ω
- B VOLUME CONTROL

