

Specifications

EW961H (EU/CIS)

	55	65	
DISPLAY	Type	OLED	
	Resolution	3,840 x 2,160 (4K UHD)	
	Brightness	470	500
BROADCASTING SYSTEM	Analog	PAL / SECAM	
	Digital	DVB-T2/C/S2	
VIDEO	Triple XD Engine	•	
	Real Cinema 24p (3:3 Pull down)	•	
	Aspect Ratio	6 modes (Standard, Cinema, Clear Voice III, Sports, Music, Game)	
AUDIO	Audio Output / Speaker System	20W + 20W / 4.0 ch	
	Sound Mode	OLED Surround	
	Wireless Sound Sync	•	
	Clear Voice	•	
GENERAL FEATURES	Type	Smart	
	Data Streaming (IP&RF)	•	
	Pro:Centric® Pro:Centric Application	PCA 3.7	
	RF (1/2 Tuner)	RF (1)	
	HCAP (SDK)	GEM / Flash / HTML5	
	Smart Features	Commercial Smart Home, Web Browser, softAP, Magic Remote Ready	
	Connectivity	Smart Share (WiDi, WiFi Direct, DIAL), Screen Share, Bluetooth Sound Sync.	
	DRM (Digital Right Management)	Pro:Idiom	
	Management	Remote Diagnostics, EzManager (for initial configuration)	
	Interactivity	HTNG/HDMI-CEC	
	RJP Interface	RS232C, HDMI	
	Advanced Setting Option	Auto Off / Auto Sleep, Motion Eye Care, Smart Energy Saving	
	Anti-theft System	Kensington Lock	
HOSPITALITY FEATURES	Welcome Screen, One Channel Map, Lock Mode, Hotel Mode, Multi-IR Code, USB Cloning, TV Link Interactive, SNMP, IR Out, External Speaker Out, External Power, Instant On		
	Side	HDMI In, USB 3.0, USB 2.0 (2), CI Slot	
INTERFACE	Rear	RF In (2), AV In, Video Component In, Digital Audio Out (Optical), HDMI Input, RS-232C, Headphone Out, LAN Port (2), External Speaker Out (2)	
	Vesa	300 x 200	
CABINET (Unit :mm)	WxHxD / weight (With Stand)	1,229 x 759 x 225 / 18.6kg	1,451 x 882 x 225 / 25.4kg
	WxHxD / weight (Carton)	1,451 x 826 x 228 / 25.1kg	1,663 x 927 x 212 / 33.5kg
POWER (Unit : Watts)	Voltage, Hz	100-240V, 50 / 60 Hz	
	Max	296.9	328.3
	Typical	253.1	283.5
	Energy saving (Min)	202.5	226.8
	Energy saving (Med)	139.2	155.9
	Energy saving (Max)	75.9	85.1
	Stand-by	0.3	
	Safety	CB, CU TR	
Environment	CE		
STANDARD APPROVAL	Etc.	ROHS, ErP	
	ErP Class	B	B
	On Power Consumption	152W	161W
	Luminance Ratio	65%	
	Mercury Content	0 mg	
	Presence of Lead	Yes	
	Average Annual Consumption (kWh)	222	235

Pro:Centric® SMART

EW961H (EU/CIS)

World's First OLED Hotel TV With IP Smart Solution

Dazzle your guests with the stunning picture quality of OLED combining with LG's smart hotel TV technologies. The EW961H model is specially designed for hotel rooms and supports guest-centric solutions. It delivers finest details of color and enhanced sound supported by Harman Kardon technology, and offers guests an unrivaled experience.



EW961H

- OLED TV – Blade Slim, Intense Colors, Infinite Contrast
- Pro:Centric® Smart
- OLED
- harman/kardon® Sound
- webOS 3.0
- Pro:Idiom®
- Bluetooth Sound Sync
- ^{NEW} Pro:Centric Direct Ready

screen size

55", 65"

Key Features



Smart Customization

Create your own solution along with LG's smart customization tools and content management software. With the tailored solution, hotel can elevate their brand to new levels.

Features

- Pro:Centric Smart SDK (HTML5, Java, Flash)
- ^{NEW} Pro:Centric Direct Ready
- Pre-loaded Apps

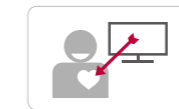

Enhanced Guests' Experience

Delight your guests with vivid picture quality and entertaining features including webOS 3.0 and its smart apps. It captivates guests' taste and brings them again.

Features

- OLED & UHD
- 4K Upscaler
- webOS 3.0 & Magic Remote (Ready)



Smart Connectivity

Cross display boundaries freely and without hassle. With LG Smart Share, mirroring and content sharing between TV and other smart devices are made incredibly easy and user-friendly.

Features

- Smart Share (WiDi, WiFi Direct, DIAL), Screen Share
- Bluetooth Sound Sync.

Dimensions

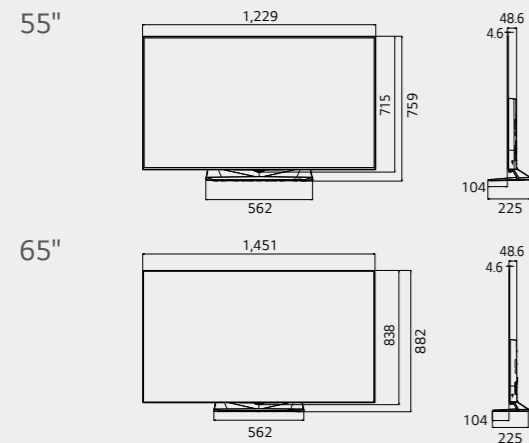

Connectivity

- 1 SPEAKER OUT
- 2 AUX LAN
- 3 LAN
- 4 H/P OUT
- 5 HDMI IN 1
- 6 OPTICAL DIGITAL AUDIO OUT
- 7 RS-232C IN
- 8 AV IN
- 9 COMPONENT IN
- 10 LNB Satellite IN
- 11 ANTENNA / CABLE IN
- 12 USB IN 1 / USB IN 2
- 13 HDMI IN 2
- 14 USB IN 3

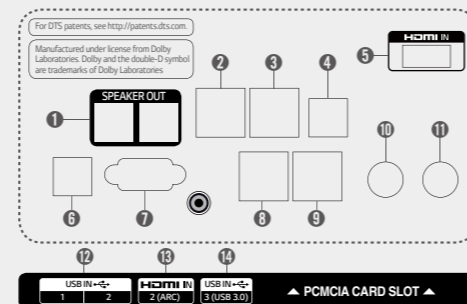

Download LG Commercial Display Mobile App



Learn more www.lg.com/b2b or www.lgcommercial.com

YouTube [youtube.com/c/LGCommercialDisplay](https://www.youtube.com/c/LGCommercialDisplay)

All screen images are simulated. Dimension and weights are approximate. Design, features and specifications subject to change without notice. © Copyright 2016 LG Electronics Inc. All Rights Reserved. Pro:Centric, the "LG" logo, XD Engine are registered trademarks or trademarks of LG Electronics Inc. Pro:Idiom is a registered trademark of Zenith Electronics LLC. All other trademarks or registered trademarks are the property of their respective owners.



Hospitality Features

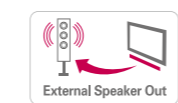

External Speaker Out

Let's users enjoy the external speaker in a separate place such as the bathroom.



Instant ON

Instant on function's high speed loading system saves and enables users to enjoy the contents immediately when they first turn on the TV.

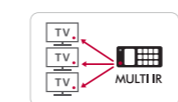

Multi IR

Multi IR function eliminates the remote control signal interference between TVs in multiple dwelling beds.



Pro:Idiom®

Prevent any illegal copying of content by the widely used DRM (Digital Right Management).



SoftAP

SoftAP means Software enabled Access Point. This "virtual" Wi-Fi feature executes by software working on the device to create a wireless hotspot.

* SoftAP should be set in installation menu after TV is on.
* Miracast may not be operated at the same time.

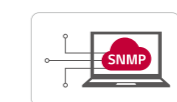

SNMP

SNMP (Simple Network Management Protocol) ensures convenient network management for SI and business managers.



World's First OLED Hotel TV With IP Smart Solution

Pro:Centric® Smart EW961H

Pro:Centric® SMART

EU/CIS

Pro: Centric Smart is an elaborate and smart mode of control and customization for commercial televisions. With the customizable tools including HTML5, Java, and Flash, users can optimize the commercial TVs according to their purposes with IP-based programs. This expansion of control provides premium hotel services to guests without the need for a set-top box. Additionally, as the Pro:Centric Smart models are compatible with Pro:Centric Server Application, you can remotely manage TVs in a centralized coaxial infrastructure you already have.

Pro:Centric Smart Application Platform

LG Pro:Centric SMART offers extended customizable tools; HTML5, Java and Flash. With these, the partners can optimize Commercial TVs to edit and develop their own enhanced service design. Also, it gives visual impact on and delivers messages to customers as users intend.

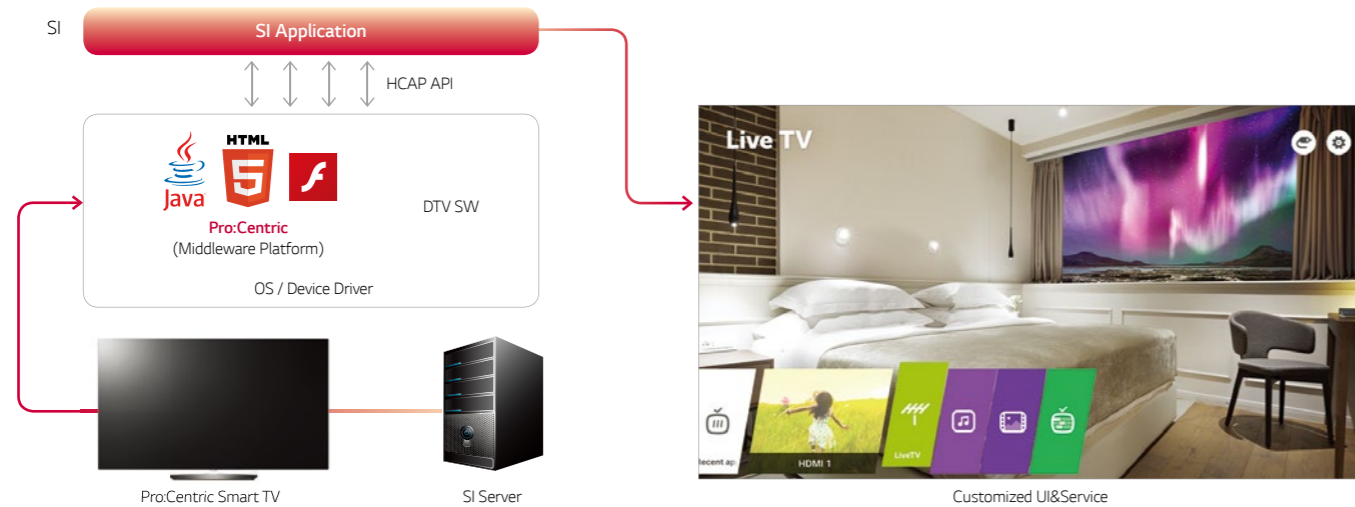

Pro:Centric Server Application

You can now differentiate your hotel with our customizable templates and pages which can be specialized for your property. Pro:Centric® provides you a solution that is easily customizable for your business.

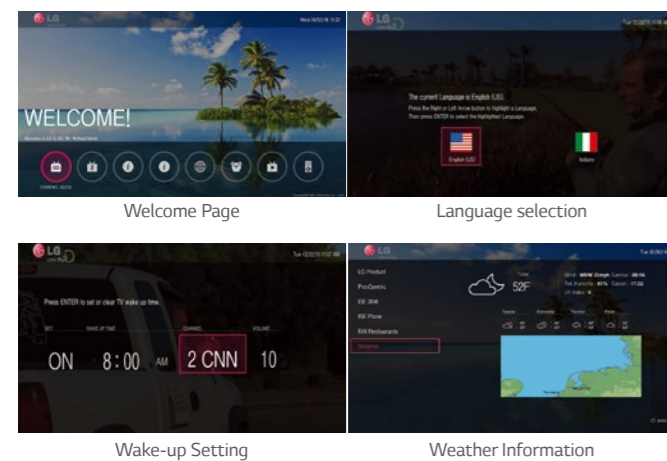

• Various Features

PCA serves the convenience of the guest through a Wake-up setting, Weather Information, Map Service, and much more functions that you can choose.

• Customizable Template & Page

Choose an alternative look & feel template based on your reference, and edit multiple sections with 40 pages of billboards by yourself with the web based tool.

Pro:Centric Direct Ready

Simply create your own templates and remotely manage TVs on the IP network with Pro:Centric Direct, LG's content management software. Pro:Centric Direct offers a project editor, along with customizable widgets and three types of theme templates (Cinematic-type, Grid-type, Bar-type)* in order to promote branding and meet guests' tastes and needs. Its interactive solution, including 1-click service, and intuitive UI impress guests while elevating their hotel experience. Plus, for hoteliers, not only does it offer efficient content production and management, but it also maximizes advertisement effectiveness, which contributes to improving the hotel brand.

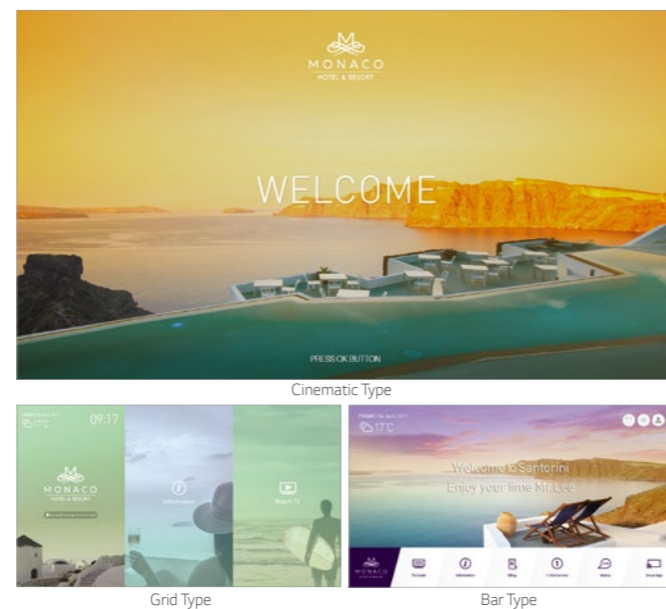

* Three types of templates will be available after Dec. 2016.

OLED TV

Blade Slim

Innovative reduction of thickness
Artistic thin design of the EW961H perfectly matches and blends into any types of hotel rooms. Its extremely thin depth makes better use of the space.



Intense Colors

Vibrant picture quality
OLED Hotel TVs bring colors to life with superb accuracy. Self-lighting pixels give the TV expanded color scope, delivering finest details of color and gradation. This enables guests to enjoy content more vividly.

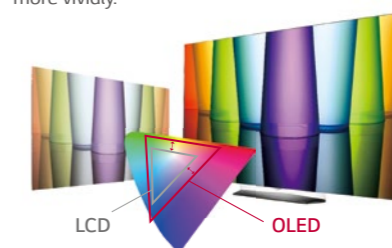

Infinite Contrast

Limitless contrast and deepest black
Self-lighting pixels switch off completely to reproduce black. No light bleed. Absolute black offers infinite contrast, and guests can appreciate its clarity.



ULTRA HD TV

4K Resolution

ULTRA HD is the future of digital picture, possessing four times higher resolution than that of full HD. Stunning 8.3 million pixels gives a flawless picture quality and incredibly vivid detail.



4K Upscaler

Enjoy Full HD content in 4K ULTRA HD quality. The 4K Upscaler automatically upgrades Full HD content to ULTRA HD through the six steps of the upscaling processes.



Smart Connectivity & Convenience

Smart Share

Smart Share allows users to share content more easily and quickly. It also searches for the content they want in order to share it more easily and accurately, thereby simplifying the process of sharing between various devices.



Bluetooth Sound Sync (Bluetooth 3.0)

Bluetooth Sound Sync enables users to listen to music on a mobile device through TV speakers via Bluetooth connection.

*Support devices for Bluetooth Sound Sync : Android (above v4.4 KitKat) / iOS based Mobile Device



Magic Remote Ready

Take control of your entertainment experience with a new level of remote control convenience. Spend less time for searching and more time for enjoying.

