



24LV760M
28LV760M
32LV760M

Hospital Grade Interactive Pro:Centric[®] TVs

Commercial Mode Setup Guide

Note: Selected features shown in this guide may not be available on all models.

EXPERIENCED INSTALLER

LG First Use Wizard
pages 17 – 18

Custom Master TV Setup
pages 54 – 56

Cloning Procedures
pages 57 – 62

For Customer Support/Service, please call:
1-888-865-3026

The latest product information and documentation is available online at:
www.lg.com/us/business

MODEL and SERIAL NUMBER

The model and serial numbers of this TV are located on the back of the cabinet. For future reference, LG suggests that you record those numbers here:

Model No. _____ Serial No. _____



WARNING:

TO REDUCE THE RISK OF ELECTRIC SHOCK DO NOT REMOVE COVER (OR BACK). NO USER-SERVICEABLE PARTS INSIDE. REFER TO QUALIFIED SERVICE PERSONNEL.



The lightning flash with arrowhead symbol, within an equilateral triangle, is intended to alert the user to the presence of uninsulated “dangerous voltage” within the product’s enclosure that may be of sufficient magnitude to constitute a risk of electric shock to persons.



The exclamation point within an equilateral triangle is intended to alert the user to the presence of important operating and maintenance (servicing) instructions in the literature accompanying the appliance.

WARNING:

TO PREVENT FIRE OR SHOCK HAZARDS, DO NOT EXPOSE THIS PRODUCT TO RAIN OR MOISTURE.

WARNING:

This product contains chemicals known to the State of California to cause cancer and birth defects or other reproductive harm. **Wash hands after handling.**

POWER CORD POLARIZATION:

This product is equipped with a 3-wire grounding-type alternating current power plug. This plug will fit into the power outlet only one way. This is a safety feature. If you are unable to insert the plug fully into the outlet, contact your electrician to replace your obsolete outlet. Do not defeat the safety purpose of the 3-wire grounding-type plug.

NOTE TO CABLE/TV INSTALLER:

This reminder is provided to call the cable TV system installer’s attention to Article 820-40 of the National Electrical Code (U.S.A.). The code provides guidelines for proper grounding and, in particular, specifies that the cable ground shall be connected to the grounding system of the building, as close to the point of the cable entry as practical.

REGULATORY INFORMATION:

This equipment has been tested and found to comply with the limits for a Class B digital device, pursuant to Part 15 of the FCC Rules. These limits are designed to provide reasonable protection against harmful interference when the equipment is operated in a residential installation. This equipment generates, uses and can radiate radio frequency energy and, if not installed and used in accordance with the instruction manual, may cause harmful interference to radio communications. However, there is no guarantee that interference will not occur in a particular installation. If this equipment does cause harmful interference to radio or television reception, which can be determined by turning the equipment off and on, the user is encouraged to try to correct the interference by one or more of the following measures:

- Reorient or relocate the receiving antenna.
- Increase the separation between the equipment and receiver.
- Connect the equipment to an outlet on a circuit different from that to which the receiver is connected.
- Consult the dealer or an experienced radio/TV technician for help.

CAUTION:

Do not attempt to modify this product in any way without written authorization from LG Electronics U.S.A., Inc. Unauthorized modification could void the user’s authority to operate this product.

COMPLIANCE:

The responsible party for this product’s compliance is: LG Electronics U.S.A., Inc.
1000 Sylvan Avenue, Englewood Cliffs, NJ 07632, USA • Phone: 1-201-816-2000

Marketed and Distributed in the United States by LG Electronics U.S.A., Inc.
1000 Sylvan Avenue, Englewood Cliffs, NJ 07632

IMPORTANT SAFETY INSTRUCTIONS

1. Read these instructions.
2. Keep these instructions.
3. Heed all warnings.
4. Follow all instructions.
5. Do not use this apparatus near water.
6. Clean only with dry cloth.
7. Do not block any ventilation openings. Install in accordance with the manufacturer's instructions.
8. Do not install near any heat sources, such as radiators, heat registers, stoves, or other apparatus (including amplifiers) that produce heat.
9. Do not defeat the safety purpose of the polarized or grounding-type plug. A polarized plug has two blades with one wider than the other. A grounding-type plug has two blades and a third grounding prong. The wide blade or the third prong are provided for your safety. If the provided plug does not fit into your outlet, consult an electrician for replacement of the obsolete outlet.
10. Protect the power cord from being walked on or pinched, particularly at plugs, convenience receptacles, and the point where it exits from the apparatus.
11. Only use attachments/accessories specified by the manufacturer.
12. Use only with the cart, stand, tripod, bracket, or table specified by the manufacturer or sold with the apparatus. When a cart is used, use caution when moving the cart/apparatus combination in order to avoid injury from tip-over.



13. Refer all servicing to qualified service personnel. Servicing is required when the apparatus has been damaged in any way, such as power-supply cord or plug is damaged, liquid has been spilled or objects have fallen into the apparatus, the apparatus has been exposed to rain or moisture, does not operate normally, or has been dropped.
14. Never touch this apparatus or antenna during a thunder or lightning storm.
15. Do not apply pressure on or scratch the TV panel during handling. Do not press against the TV panel with your hand or a sharp object such as a nail, pencil, or pen.

16. Power Cord

Caution: Check the TV specifications in the Owner's Manual to determine power requirements.

Periodically examine the cord of your appliance, and if its appearance indicates damage or deterioration, unplug it, discontinue use of the appliance, and have the cord replaced with an exact replacement part by an authorized servicer. Protect the power cord from physical or mechanical abuse, such as twisting, kinking, or pinching or being closed in a door or walked upon. Pay particular attention to plugs, wall outlets, and the point where the cord exits the appliance.

Do not use a damaged or loose power cord. Be sure to grasp the plug when unplugging the power cord. Do not pull on the power cord to unplug the TV.

Do not stick metal objects or any other conductive material into the power cord. Do not touch the end of the power cord while it is plugged in.

17. Overloading

Do not connect too many appliances to the same AC power outlet as this could result in fire or electric shock. Do not overload wall outlets. Overloaded wall outlets, loose or damaged wall outlets, extension cords, frayed power cords, or damaged or cracked wire insulation are dangerous. Any of these conditions could result in fire or electric shock.

18. Outdoor Use/Wet Location



Warning: To reduce the risk of fire or electrical shock, do not expose this product to rain, moisture or other liquids.

Do not touch the TV with wet hands. Do not install this product near flammable objects such as gasoline or candles or expose the TV to direct air conditioning.

Do not expose to dripping or splashing and do not place objects filled with liquids, such as vases, cups, etc., on or over the apparatus (e.g., on shelves above the unit).

19. Grounding

Ensure that you connect the earth ground wire to prevent possible electric shock (i.e., a TV with a three-prong grounded AC plug must be connected to a three-prong grounded AC outlet). If grounding methods are not possible, have a qualified electrician install a separate circuit breaker. Do not try to ground the unit by connecting it to telephone wires, lightning rods, or gas pipes.

20. Disconnect Device

The power plug is the disconnecting device. The power plug must remain readily accessible.

As long as this unit is connected to the AC wall outlet, it is not disconnected from the AC power source even if the unit is turned off.

(Continued on next page)

IMPORTANT SAFETY INSTRUCTIONS

(Continued from previous page)

21. Outdoor Antenna Grounding

If an outside antenna or cable system is connected to the product, follow the precautions below.

An outdoor antenna system should not be located in the vicinity of overhead power lines or other electric light or power circuits or where it can come into contact with such power lines or circuits as death or serious injury can occur.

Be sure the antenna system is grounded so as to provide some protection against voltage surges and built-up static charges.

Article 810 of the National Electrical Code (NEC) in the U.S.A. provides information with respect to proper grounding of the mast and supporting structure, grounding of the lead-in wire to an antenna-discharge unit, size of grounding conductors, location of antenna-discharge unit, connection to grounding electrodes, and requirements for the grounding electrode.

Antenna Grounding According to NEC, ANSI/NFPA 70

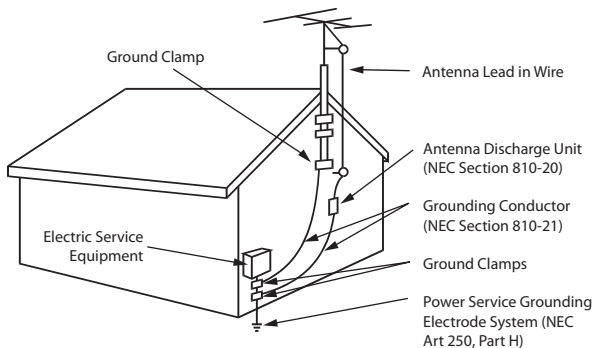

22. Cleaning

When cleaning, unplug the power cord and wipe gently with a soft cloth to prevent scratching. Do not spray water or other liquids directly on the TV as electric shock may occur. Do not clean with chemicals such as alcohol, thinners or benzene.

23. Transporting Product

Make sure the TV is turned off and unplugged and that all cables have been removed. It may take two or more people to carry larger TVs. Do not press against or put stress on the front panel of the TV.

24. Ventilation

Install the TV where there is proper ventilation. Do not install in a confined space such as a bookcase. Do not cover the TV with cloth or other materials (e.g., plastic) while it is plugged in. Do not install in excessively dusty places.

25. If you smell smoke or other odors coming from the TV or hear strange sounds, unplug the power cord, and contact an authorized service center.

26. Keep the product away from direct sunlight.

27. When mounting a TV on the wall, make sure that none of the electrical cabling bears any of the weight of the TV. Install in accordance with the manufacturer's instructions.

28. Do not install this product on a wall if it could be exposed to oil or oil mist. This may damage the product and cause it to fall.

29. Do not allow an impact shock or any objects to fall into the product, and do not drop objects onto the screen.

30. Do not touch the ventilation openings, as they may become hot while the TV is operating. This does not affect the performance of the product or cause defects in the product.

31. Do not use high voltage electrical equipment near the TV (e.g., a bug zapper). This may result in product malfunction.

32. Dot Defect

This panel is an advanced product that contains millions of pixels. In a very few cases, you could see fine dots on the screen while you are viewing the TV. Those dots are deactivated pixels and do not affect the performance and reliability of the TV.

33. Generated Sound

“Cracking”: A cracking noise that occurs while the TV is on or when it is turned off is generated by plastic thermal contraction due to temperature and humidity. This noise is common for products where thermal deformation is required.

Electrical circuit humming/panel buzzing: A low level noise is generated from a high-speed switching circuit, which supplies a large amount of current to operate a product. It varies depending on the product. This generated sound does not affect the performance and reliability of the product.

34. If the TV feels cold to the touch, there may be a small “flicker” when it is turned on. This is normal; there is nothing wrong with the TV. Some minute dot defects may be visible on the screen, appearing as tiny red, green, or blue spots. However, they have no adverse effect on the TV's performance. Avoid touching the screen or holding your finger(s) against it for long periods of time. Doing so may produce some temporary distortion effects on the screen.

35. Displaying a still image for a prolonged period of time may cause image burn-in. Avoid displaying a fixed image on the TV screen for an extended length of time.

Table of Contents

Safety Warnings	2	Custom Master TV Setup.	54–56
Important Safety Instructions	3–4	Before You Begin	54
Table of Contents	5–6	Clonable TV Setup Menu Features	54
Commercial Mode Overview	7–11	Custom Master TV Setup Procedure	55
Setup Checklist	7	Cloning Procedures	57–62
Pass-through Mode	7	Exporting a Clone File	57
FTG Mode	8	Importing a Clone File	59
Application Tuning Mode / Pro:Centric Direct	10	Cloud Configuration Tool Overview	63–69
Determining the TV Operating Mode	10	Creating an FTG Configuration File	63
Pro:Centric Operation	12–16	File Manager Web Page Overview	66
Interactive Menu Features	12	Channel Map Web Page Overview	67
Interactive Menu Navigation	12	Installer Menu Web Page Overview	69
Pro:Centric Java Application Setup	14	IP Environment Setup	70–79
Pro:Centric HTML Application Setup	15	Accessing the IP Environment Menu	70
LG First Use Wizard	17–18	Network Configuration	70
Before You Begin	17	Pro:Centric Setup	74
Initiate Configuration or Exit the LG First Use Wizard	18	Media Share Setup	77
EZ-Manager Wizard	19–27	Pre-loaded Applications	79
Initiate the EZ-Manager Wizard	19	References	
TV Configuration Options	20	Updating TV/PTC Software using a USB Memory	
Zones and Room Number Assignments	20	Device	80–81
Configure Pro:Centric Settings	22	Downloading a Splash Screen Image using a USB	
USB Configuration	26	Memory Device	82–83
Express Script	28–38	Downloading Background Images using a USB	
Initiate the Express Script	28	Memory Device	84–85
Configure Pro:Centric Settings	28	Power Consumption Settings	86
Complete the TV Configuration	31	TV Aux Input Configuration	87
Channel Banks Overview	36	Auto Input(s) Sensing Feature	88–89
Ez Download Utility	39–42	LV760M Hospital Operations	90–91
Before You Begin	39	Restoring Factory Defaults on the TV(s)	92
Accessing and Using the Ez Download Utility	39	Using the TV's Zoning Features	93–96
Installer Menu	43–53	Using Media Share Features	97–100
Accessing the Installer Menu	43	24/28LV760M Rear and Side Jack Panels	101
Navigating Within the Installer Menu	44	32LV760M Rear and Side Jack Panels	102
Modifying Installer Menu Settings	44	Installer Remote Control Typical Key Functions	103
Exiting the Installer Menu and Activating Settings	44	LG Pro:Centric Patient Remote and Pillow	
Detailed Descriptions of Installer Menu Items	47	Speaker	104–105
		Pillow Speaker Setup	106

Notes

- Installer Menu content is intended for use primarily by qualified TV electronics technicians.
- Refer to the applicable Owner's Manual and/or Easy Setup Guide for additional information on TV installation, specifications, maintenance, and safety instructions.
- Design and specifications subject to change without prior notice. This document provides examples of typical TV displays. Your displays may vary from those shown in this document.

Table of Contents (Cont.)

VESA Standard TV Mounts	107
TLM Communication Parameters	108–114
Troubleshooting	115–117
General Troubleshooting	115
Commercial Mode Check	116
Channel Banks Setup Troubleshooting	117
Glossary of Terms	118
Document Revision History / Open Source Software	
Notice	119
Back Cover	120

This document describes how to set up LV760M Pro:Centric® TVs for Commercial Mode operation. LG commercial TV functionality is based on “ownership” of the Channel Map; that is, the Channel Map resides in the TV’s CPU or Protocol Translation Controller (PTC), or it resides in a Pro:Centric application or an external device from the solution provider.

These TV models support several different operational modes: LG’s Free-To-Guest (FTG) Mode via the TV CPU, Application Tuning Mode (ATM) with Pro:Centric application, or Pass-through Mode (default). When in Pass-through Mode, these TV models can also be externally controlled via Multiple Protocol Interface (MPI) or TV-Link Monitor (TLM) interface.

Setup Checklist

Note: This document provides information specific to Commercial Mode operation. Refer to the Owner’s Manual and/or Easy Setup Guide for information on TV installation and hardware and cable connections.

Installation

- Unpack TV and all accessories.
 - Install batteries in the Installer Remote.
 - Install TV on VESA mount or stand.
- Note:** It may be advisable to make all cable connections before installing on VESA mount or stand, as appropriate.

Cable Connections

- Make all rear jack panel connections, as appropriate.

Commercial Mode Setup

- Complete appropriate procedures as described in this document for Commercial Mode operation.

Hardware Connections

- Install any additional hardware as appropriate to your institution, LAN, etc.

Pass-through Mode

This mode allows you to configure individual TVs for Pro:Centric and/or FTG Mode operation. This mode also allows external control via either the MPI port or the TLM (CONTROL & SERVICE) port on the TV rear jack panel.

There are three methods for configuring individual TVs that are currently in Pass-through Mode: using one of the two LG First Use Wizard options or using the Custom Master TV Setup procedure.

LG First Use Wizard Configuration

When the TV is in a factory default state, the LG First Use Wizard provides the following two configuration options. See “LG First Use Wizard” on pages 17 to 18 for further information.

- The EZ-Manager Wizard provides automated or manual options for configuring Pro:Centric operation and also provides the option to configure the TV using a USB memory device.
- The Express Script provides streamlined configuration of the TV for FTG Mode via CPU operation with Hospital Mode features (including pillow speaker setup) and also provides the option to configure the TV for Pro:Centric operation.

Custom Master TV Setup

Unlike the guided process above, the Custom Master TV Setup procedure enables you to create a customized Master TV Setup for cloning purposes for TVs that are to remain in Pass-through Mode. Use the Installer Remote to configure Installer Menu items as required for TV operation and set up TV features (Picture, Sound, Channels, etc.). See “Custom Master TV Setup” on pages 54 to 56 for detailed information.

Commercial Mode Overview (Cont.)

Installer Menu

To create a Master TV Setup, you will need to know how to access the commercial controller (PTC) Installer Menu and make changes to the default values as required. If necessary, familiarize yourself with the Installer Menu and how to make and save changes. See pages 43 to 53 for information on accessing the Installer Menu and for detailed descriptions of the Installer Menu items.

TV Setup Menus

On-screen setup menus control the features of the TV. Use the Installer Remote to access the TV setup menus, and set the TV features to the desired configuration for the end user.

Cloning

Cloning refers to the process of using a Master TV Setup to configure a Target TV. The Master TV's clonable setup menu features should be configured as part of the Master TV Setup. If there are features in the Master TV's setup—channel icons or labels, digital font options, etc.—that are not set or that are set incorrectly, those features also will not be set or will be set incorrectly in the Target TVs. See pages 57 to 62 for detailed information on Clone (.ttx) files and cloning requirements and procedures.

External MPI or TLM Control

To control the TV using an external MPI control device, you must use the TV's MPI port for communication purposes.

To control the TV using an external TLM control device, you must use the TV's CONTROL & SERVICE port for communication purposes. See Reference section, "TLM Communication Parameters," for further information.

FTG Mode

In this mode, the TV's CPU is configured with an FTG Channel Map, and the CPU controls and restricts the tuning operation of the TV based on this FTG Channel Map. The FTG Channel Map enables the decryption of each Pro:Idiom[®] encrypted channel and also provides logical channel mapping of physical RF channels (digital and analog), IP streams, and Aux inputs. In addition, in these models, depending on the types of channels included in the FTG Channel Map, FTG Mode provides the option to select either logical or physical tuning (see notes below) during configuration.

Note: Logical channel mapping of physical RF channels eliminates dash tuning; for example, physical 19-3 can be mapped to logical channel 9. It also allows physical RF channels, IP streams, and Aux inputs to be listed in any order, not only in physical numeric ascending order. Physical channel tuning requires that you include the dash when direct entering RF channel numbers and Aux inputs (the latter designated by 130-0 through 137-0).

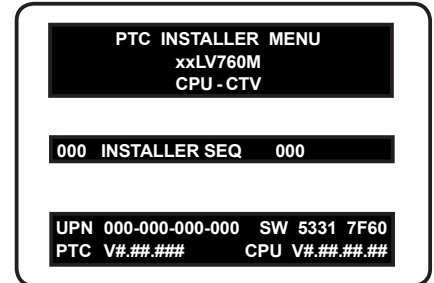

Typical Installer Menu

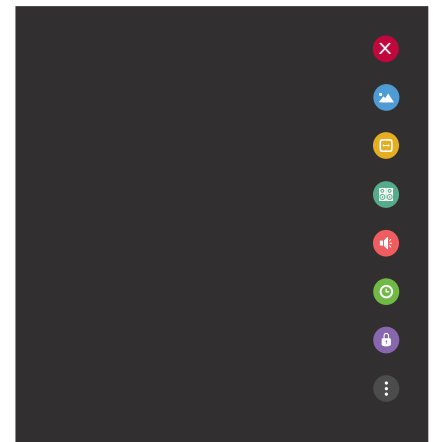

TV Setup Menus (Quick Settings)

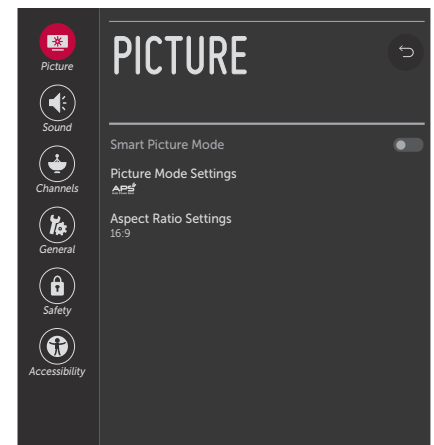

TV Setup Menus (Advanced Settings)

Note: Physical channel tuning is not available when IP channels are included in the FTG Channel Map.

FTG Mode Features

This mode provides the following features:

- Logical or physical channel tuning of physical RF channels and Aux inputs.
- Logical channel tuning of IP streams.
- Mapping of RF channels with minor (program) numbers up to 999.
- FTG Channel Map of up to 600 channels.
- Start Channel set for RF, Aux input, or IP delivered content.
- Pro:Centric data delivery over RF or IP.
- TV Zoning (including channel restrictions by Zone) and Wi-Fi Zoning options for location-specific configurations.

LG's Cloud Configuration Tool enables you to create an FTG Configuration (.tlx) file, which may be used to configure the CPU for FTG Mode. Configuration utilities enable you to create/edit an FTG Channel Map and configure Installer Menu settings. You can also create a Clone (.tlx) file from a Master TV Setup that may be used to configure the CPU for FTG Mode.

Note: TV Zoning and Wi-Fi Zoning features are supported via ".tlx" file. See Reference section, "Using the TV's Zoning Features," for further information.

In this mode, the TV's CPU must be configured with an FTG Channel Map and FTG Installer Menu settings using one of the following processes:

- Local: Configure an individual LV760M TV via its USB port using a USB memory device / ".tlx" file. The file may be either a Clone file (see "Cloning Procedures" on pages 57 to 62) or an FTG Configuration file (see "Cloud Configuration Tool Overview" on pages 63 to 69).
- Remote: Configure all LV760M TVs at the site using a Pro:Centric server head end device (Example: PCS200S). Refer to the **Pro:Centric Server Admin Client User Guide** for further information.

While the TV is in FTG Mode:

- Users can still access the Installer Menu using an LG Installer Remote; however, all Installer Menu items will be read-only.
- Any FTG Mode configuration changes must be made using a ".tlx" file (typically edited in the Cloud Configuration Tool). Channel Map and Installer Menu configuration utilities enable you to make changes, respectively, to the FTG Channel Map and FTG Installer Menu settings as necessary. See information on local configuration in this document or refer to documentation for the server for information on remote management.
- If it becomes necessary to restore the TV to Pass-through Mode, there are several options that will enable you to do so. See Reference section, "Restoring Factory Defaults on the TV(s)," for further information.

Pages 63 to 69 provide overviews of the utilities that comprise the Cloud Configuration Tool. Refer to the **Cloud Configuration Tool User Guide** for further information on the Cloud Configuration Tool.

Remote Management in FTG Mode

When the TV is configured for FTG Mode, remote management of the FTG Channel Map and FTG Installer Menu settings is provided by a Pro:Centric server, via a Clone/Configuration (.tlx) file loaded on the Pro:Centric Admin Client. Refer to the **Pro:Centric Server Admin Client User Guide** for further information.

Commercial Mode Overview (Cont.)

Application Tuning Mode / Pro:Centric Direct

In Application Tuning Mode, the TV's Channel Map resides in an application, such as LG's Pro:Centric Direct HTML application. With Pro:Centric Direct, the Channel Map is created in the Pro:Centric server's Admin Client web editor, and the tuning operation of the TV is controlled and restricted based on this Pro:Centric Direct Channel Map.

Application Tuning Mode with the Pro:Centric Direct HTML application provides the following features:

- Decryption of each Pro:Idiom[®] encrypted channel.
- Logical channel tuning of physical RF channels (digital and analog) and IP streams.
- Mapping of RF channels with minor (program) numbers up to 999.
- Start Channel set for RF or IP delivered content.
- Pro:Centric data delivery over RF or IP.
- TV Zoning (Installer Menu items only) and Wi-Fi Zoning options for location-specific configurations.

You must use the Pro:Centric Direct Admin Client / Channel Map configuration utility to create the Pro:Centric Direct Channel Map, define channel attributes, and set the Start Channel. Refer to the ***Pro:Centric Direct Admin Client User Guide*** for further information.

Note: TV Zoning and Wi-Fi Zoning features are supported via “.tlx” file—typically a Clone (.tlx) file that has been created from a Master TV Setup. See Reference section, “Using the TV's Zoning Features,” for further information.

While the TV is in Application Tuning Mode:

- Users can still access the Installer Menu using an LG Installer Remote; however, all Installer Menu items will be read-only.
- While it is possible to update a TV's Installer Menu and/or Setup Menu settings locally using a USB memory device / Clone (.tlx) file, any Pro:Centric Direct configuration changes are typically made remotely via the Pro:Centric server / Pro:Centric Direct Admin Client. The Admin Client's Channel Map configuration utility enables you to create and edit the Pro:Centric Direct Channel Map, while the TV Configuration utility (in conjunction with a Clone [.tlx] file loaded on a server carousel) enables you to make changes to TV Installer Menu and/or Setup Menu settings.
- If it becomes necessary to restore the TV to Pass-through Mode, it is possible to do so. See Reference section, “Restoring Factory Defaults on the TV(s),” for further information.

Refer to the ***Pro:Centric Direct Admin Client User Guide*** for further information on configuration and management via the Pro:Centric Direct Admin Client.

Determining the TV Operating Mode

To determine the operating mode of the TV, press **MENU** on the Installer Remote. The menu displayed depends on the operating mode. See examples below.

If the Function Menu appears, the TV is in a mode (FTG, ATM, PPV, etc.) that does not allow the end user to change the fundamental TV setup. If the TV setup menus (Quick Settings) appear, the TV is in Pass-through Mode.

Commercial Mode Overview (Cont.)

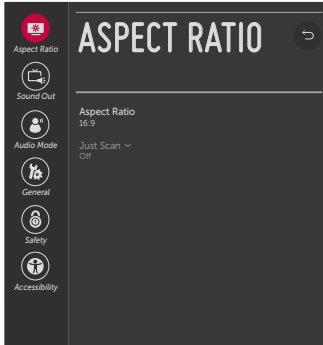

Function Menu
Indicates the TV is not in Pass-through Mode. While the TV is in this mode, Installer Menu settings can be accessed as read-only.

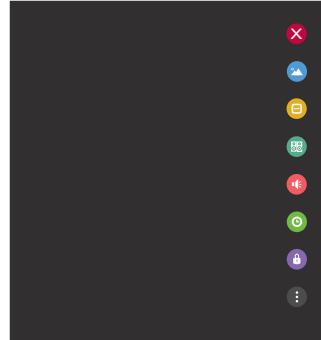

TV Setup Menus
Shows that the TV is in Pass-through Mode.

Pro:Centric Operation

These TV models support LG's Pro:Centric Java application, as well as the Pro:Centric Direct HTML application. Only one application may be implemented at a time. The following sections provide an overview of the application features and functionality.

Interactive Menu Features

Both the Pro:Centric Java application and the Pro:Centric Direct HTML application enable patients and visitors to locate and select television entertainment, check the daily weather, view hospital and surrounding amenities, etc. via custom portal interactive menus. The Pro:Centric Java application provides multiple templates for portal interactive menus, while the Pro:Centric Direct HTML application, in addition to providing multiple templates for portal interactive menus, also enables you to custom-create portal and application content.

Pro:Centric application features include:

- Portal and information screens/pages (including a "Welcome" page) that include branding logos.
- An optional customized user interface (custom "skins").
- Billboards and points-of-interest maps, which can be customized to focus on hospital amenities, local attractions and businesses, hotels, restaurants, news, events, etc.
- An optional Weather billboard that includes a local radar map, current conditions, and a four day forecast.
- An interactive channel guide that provides a channel list with channel icons. An electronic program guide (EPG) is an optional feature that displays up to three days of programming information viewable by channel and time.
- Video spooling that enables the hospital to deliver a video file to patient and visitor TVs for promotion and information purposes.

In addition to the those indicated above, the Pro:Centric Direct HTML application also offers the following features:

- Optional messaging features, including notices, ticker text, and ad banners.
- Additional media support, specifically music accompaniment, for portal displays.
- An optional flight information display.

For each Pro:Centric application, an Admin Client web editor/content wizard is provided for customer configuration of portal content. The Pro:Centric Direct Admin Client features the Pro:Centric Direct Project Editor, which provides design tools (including templates) that enable customization of all portal pages. Please contact your LG service representative for further information.

Note: Customized content is typically defined by the service integrator and/or hospital administrators. LG does not provide hospital-specific content.

Interactive Menu Navigation

LG's Pro:Centric pillow speaker provides access to both interactive menus and regular TV features. Press **PORTAL** on the Pro:Centric pillow speaker to access the interactive menus.

Interactive menu options may vary, depending on Pro:Centric features enabled for the site and/or customized content. The following examples show typical portal interactive menus.

Example: Pro:Centric Java Application Portal

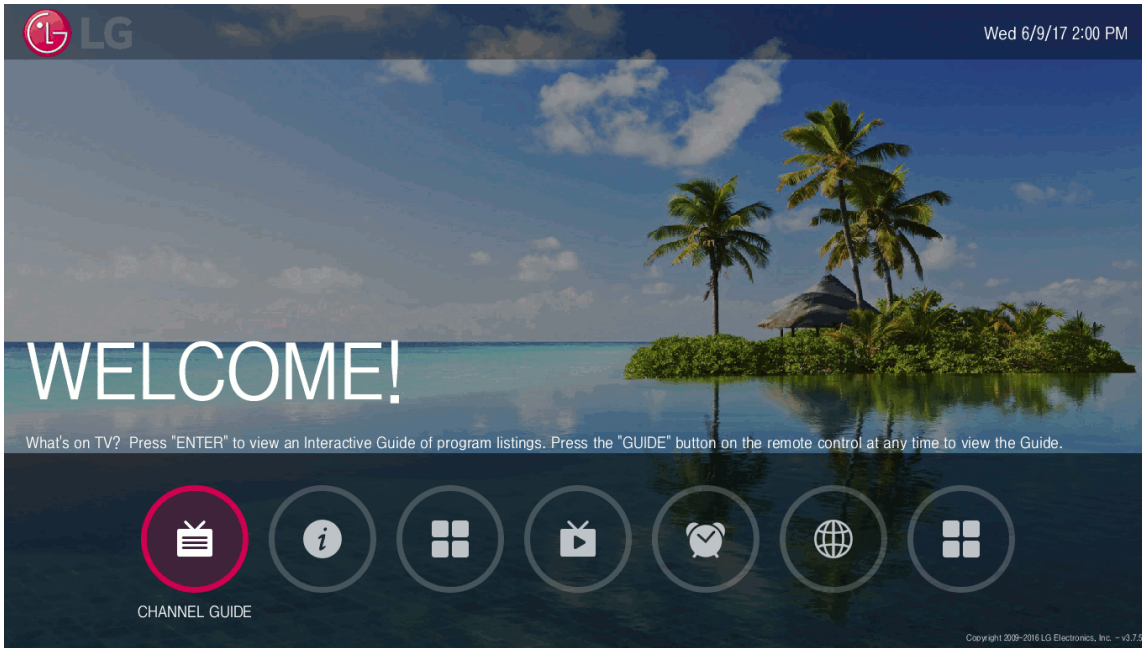

Example: Pro:Centric Direct HTML Application Portal

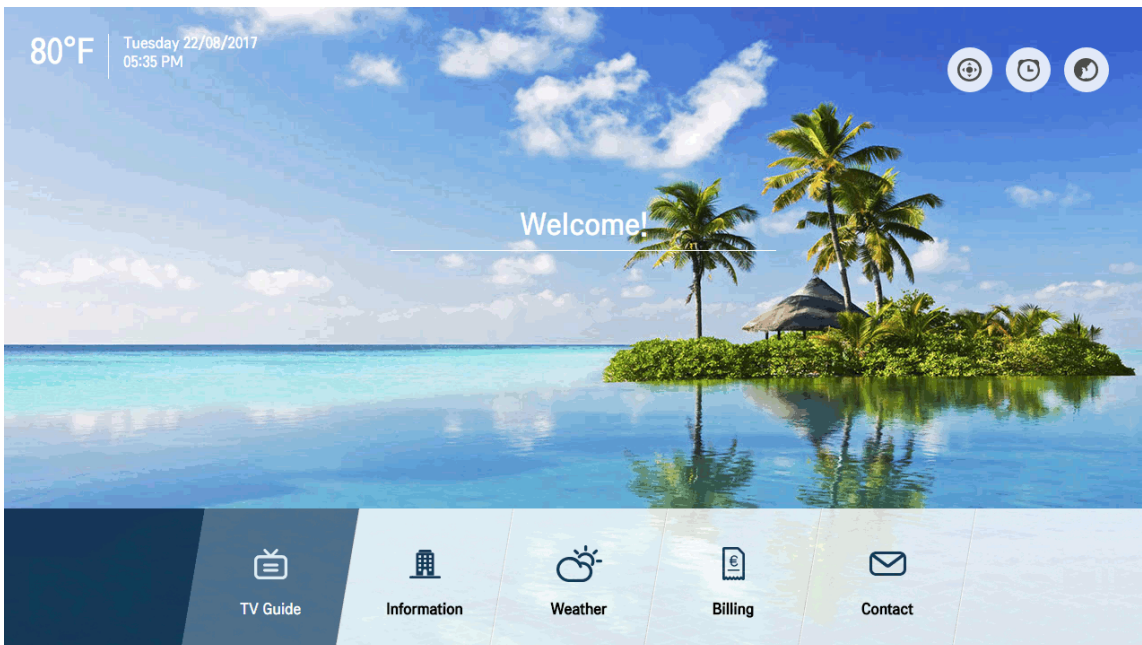

Pro:Centric Operation (Cont.)

Pro:Centric Java Application Setup

The Pro:Centric Java application operates in conjunction with FTG and PPV Modes. This section provides an overview of the setup required for the Pro:Centric features. Administration and management options for the Pro:Centric server are described in detail in the **Pro:Centric Server Admin Client User Guide**. This document describes only those settings that must be specified on the TVs to enable Pro:Centric remote management and/or the Pro:Centric Java application.

- Remote management (TV E-Z Installation): The Pro:Centric Admin Client provides remote management facilities for downloading splash screen image and software/firmware updates as well as facilities for downloading a Clone/Configuration (.tlx) file for FTG Mode via CPU configuration.
- Pro:Centric Java application: The application comprises the Pro:Centric interactive menus/features described on page 12. Pro:Centric application settings are managed via the Pro:Centric Admin Client for the Java application.

The Pro:Centric remote management facilities and application download are based on Installer Menu item settings that are used to set up the TV's Pro:Centric features. The Installer Menu / Pro:Centric server settings can be configured using one of the methods described below.

Note: If using a Pro:Centric pillow speaker, also set Installer Menu item 027 HOSPITAL MODE to the required value.

TV in Factory Default State

When the TV is in a factory default state, LG's First Use Wizard (see pages 17 to 18) provides automated or manual options for configuring the Pro:Centric server settings. The First Use / EZ-Manager Wizard also provides a USB configuration option that enables you to configure a TV for FTG Mode using a Clone/Configuration (.tlx) file stored on a USB memory device. The ".tlx" file incorporates FTG Installer Menu settings, including Installer Menu items 098 PRO:CENTRIC and 119 DATA CHANNEL, which are used to set up the TV's Pro:Centric features.

Note: If Pro:Centric data delivery will be over IP, there is a Domain Name System (DNS) server at the site, and you intend to use the EZ-Manager Wizard to set up the TV, you can create a "procentric.local" DNS entry for the Pro:Centric server that will enable automated Pro:Centric IP configuration via the EZ-Manager. If there is no DNS entry for procentric.local, you will need to manually enter the Pro:Centric server IP address and port number during configuration.

TV in Pass-through Mode

If the First Use Wizard has been exited and the TV is in Pass-through Mode, either:

- Set Installer Menu items 098 PRO:CENTRIC and 119 DATA CHANNEL to the appropriate values. See Installer Menu information on pages 43 to 53 for further details. Also, as necessary, refer to "Custom Master TV Setup" on pages 54 to 56 and/or cloning information on pages 57 to 62.
- Configure the appropriate Pro:Centric server settings in the IP Environment / Pro:Centric Menu. You must use this option, in particular, if you wish to configure IP settings for the Pro:Centric server. See "Accessing the IP Environment Menu" on page 70 and "Pro:Centric Setup" on pages 74 to 76 for further information.

Note: When the TV is in either Pass-through Mode or FTG Mode via CPU, you can also leave Installer Menu item 119 DATA CHANNEL set to its default value (255) to enable the TV's Data Channel Auto Search feature to set the DATA CHANNEL value. See item 119 description on page 53 for additional information.

TV in FTG Mode

If the TV is already in FTG Mode, use the Cloud Configuration Tool to update Installer Menu items #98 Pro:Centric and #119 Data Channel (along with their affiliated fields). Then, transfer the FTG Installer Menu settings to the TV. Refer to the FTG Mode overview on pages 8 to 9 for further information on FTG Mode operation and configuration. Also, see note above regarding the option to use the TV's Data Channel Auto Search feature to set the DATA CHANNEL value.

Pro:Centric Direct HTML Application Setup

The Pro:Centric Direct HTML application operates only in Application Tuning Mode (ATM). This section provides an overview of the setup required for the Pro:Centric Direct features. Administration and management options for the Pro:Centric server are described in detail in the **Pro:Centric Direct Admin Client User Guide**. This document describes only those settings that must be specified on the TVs to enable Pro:Centric remote management and/or the Pro:Centric Direct HTML application.

- Remote management (TV E-Z Installation): The Pro:Centric Direct Admin Client provides remote management facilities for downloading splash screen image and software/firmware updates as well as facilities for downloading Installer Menu configuration updates via Clone (.tlx) file to the TVs at the site/institution.
Note: The Pro:Centric Direct Channel Map is created and maintained in the Pro:Centric Direct Admin Client. Thus, any Clone file that is loaded on the server for remote configuration may only contain Installer Menu and/or Setup Menu profiles.
- Pro:Centric Direct HTML application: The application comprises the Pro:Centric interactive menus/features described on page 12. Pro:Centric Direct application settings are managed via the Pro:Centric Direct Admin Client.

The Pro:Centric remote management facilities and application download are based on Installer Menu item settings that are used to set up the TV's Pro:Centric features. The Installer Menu / Pro:Centric server settings can be configured using one of the methods described below.

TV in Factory Default State

When the TV is in a factory default state, LG's First Use Wizard (see pages 17 to 18) provides automated or manual options for configuring the Pro:Centric server settings. The First Use / EZ-Manager Wizard also provides a USB configuration option that enables you to configure the TV's Installer Menu settings using a Clone (.tlx) file stored on a USB memory device. Installer Menu items 098 PRO:CENTRIC and 119 DATA CHANNEL are used to set up the TV's Pro:Centric features.

Note: If Pro:Centric data delivery will be over IP, there is a Domain Name System (DNS) server at the site, and you intend to use the EZ-Manager Wizard to set up the TV, you can create a "procentric.local" DNS entry for the Pro:Centric server that will enable automated Pro:Centric IP configuration via the EZ-Manager. If there is no DNS entry for procentric.local, you will need to manually enter the Pro:Centric server IP address and port number during configuration.

TV in Pass-through Mode

If the First Use Wizard has been exited and the TV is in Pass-through Mode, either:

- Set Installer Menu items 098 PRO:CENTRIC and 119 DATA CHANNEL to the appropriate values. See Installer Menu information on pages 43 to 53 for further details. Also, as necessary, refer to "Custom Master TV Setup" on pages 54 to 56 and/or cloning information on pages 57 to 62.

Pro:Centric Operation (Cont.)

- Configure the appropriate Pro:Centric server settings in the IP Environment / Pro:Centric Menu. You must use this option, in particular, if you wish to configure IP settings for the Pro:Centric server. See “Accessing the IP Environment Menu” on page 70 and “Pro:Centric Setup” on pages 74 to 76 for further information.

Note: When the TV is in either Pass-through Mode or Application Tuning Mode, you can also leave Installer Menu item 119 DATA CHANNEL set to its default value (255) to enable the TV’s Data Channel Auto Search feature to set the DATA CHANNEL value. See item 119 description on page 53 for additional information.

TV in Application Tuning Mode

If the TV is already in Application Tuning Mode, use a Master TV of the same model to create and export a Clone (.tix) file with the desired settings for Installer Menu items 098 PRO:CENTRIC and 119 DATA CHANNEL. Then, transfer (import) the Clone file to the Target TV. Refer to the Application Tuning Mode / Pro:Centric Direct overview on page 10 for further information on Pro:Centric Direct operation and configuration. To transfer the Clone file remotely, use the appropriate utilities in the Pro:Centric Direct Admin Client to upload the Clone file to the Pro:Centric server and set up its distribution to the Target TV(s) at the site. See also note above regarding the option to use the TV’s Data Channel Auto Search feature to set the DATA CHANNEL value.

Note: After it is turned ON, the TV begins an initialization process, and it may take several minutes for the LG First Use Wizard to appear.

The LG First Use Wizard, comprising EZ-Manager Wizard and Express Script configuration options, will appear on the screen each time the TV is turned ON, until one of its configuration methods has been completed or the wizard is exited. Use the Installer Remote to make selections and complete each step.

- The primary purpose of the EZ-Manager Wizard is to guide you through the process (automated or manual) of configuring the essential Installer Menu items for Pro:Centric operation. However, while intended primarily for Pro:Centric-related configuration, the EZ-Manager Wizard also offers Zoning options. LV760M TVs support the TV Zoning and Wi-Fi Zoning features, both of which enable location-specific configurations (see Reference section, “Using the TV’s Zoning Features,” for further information). The EZ-Manager Wizard enables you to set the TV Zone # and/or the Wi-Fi Zone # in the TV as part of the configuration process.

The EZ-Manager Wizard also enables you to access the TV Manager / USB download options as part of the configuration process, if desired, to perform USB configuration and/or update functions.

- The Express Script guides you through the process of configuring the TV for FTG Mode via CPU operation with Hospital Mode features. This includes setting up the pillow speaker, as required, as well as setting up channel banks (up to four) for tiered channel programming. The Express Script also enables you to configure the Pro:Centric settings on the TV.

Note that the Express Script uses the TV’s standard RF Auto Tuning feature to create the TV’s channel lineup; IP channels are not supported.



Caution: Do NOT unplug the TV power cord or remove the antenna cable or, if applicable, the LAN cable during the configuration process, as doing so will interrupt the current step and may corrupt the configuration data.



Note: If you do not intend to complete the Express Script, but you wish to enable Hospital Mode (pillow speaker functionality and also channel banks), you must set Installer Menu item 027 HOSPITAL MODE appropriately. See the “Installer Menu” section of this document for further information.

Before You Begin

- If you plan to create a customized Master TV Setup using the procedure described on pages 54 to 56, be sure to exit the LG First Use Wizard in order to avoid setup conflicts or setting modes that may cause the TV to malfunction or restrict the custom setup procedure. See also “Initiate Configuration or Exit the LG First Use Wizard” on the following page.
- If it has been completed or exited and therefore does not display, the First Use Wizard can be reactivated; however, this requires that you restore the TV to a factory default condition. See Reference section, “Restoring Factory Defaults on the TV(s),” for further information.
- If you would like to enable the SoftAP and/or DIAL Media Share features or select pre-loaded/ Smart Launcher applications on a TV that will eventually be configured for FTG Mode, you will need to use the IP Environment Menu to do so before the TV is configured for FTG Mode. Refer to “IP Environment Setup” on pages 70 to 79 for information on the IP Environment Menu. See also “Custom Master TV Setup” on pages 54 to 56.

LG First Use Wizard (Cont.)

Initiate Configuration or Exit the LG First Use Wizard

The Welcome screen provides a brief introduction to the LG First Use Wizard.

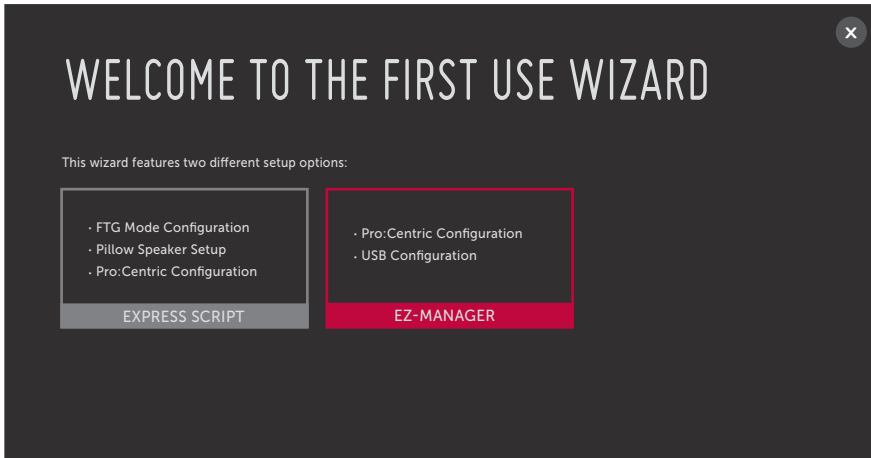

Note: Once you proceed with one of the configuration options, it is not possible to return to the First Use Wizard Welcome screen; however, if you simply wish to exit the EZ-Manager Wizard or Express Script (depending on your selection from the First Use Wizard Welcome screen), you can do so by selecting the **✕** button from the subsequent screen(s).

From the Welcome screen, you have the following options:

- To proceed with the EZ-Manager Wizard, use the arrow keys on the Installer Remote to select/highlight **EZ-MANAGER**, and then press **OK**. Then, continue to the “EZ-Manager Wizard” section on pages 19 to 27.
- To proceed with the Express Script, use the arrow keys on the Installer Remote to select/highlight **EXPRESS SCRIPT**, and then press **OK**. Then, continue to the “Express Script” section on pages 28 to 37.
- To exit the First Use Wizard, use the arrow keys on the Installer Remote to select/highlight the **✕** button at the top right of the screen, and then press **OK**. In the confirmation pop-up window, select **EXIT**, and then press **OK** once more on the Installer Remote.

Note: Both the EZ-Manager Wizard and the Express Script enable you to configure Pro:Centric settings on this TV, even if you do not intend to configure any of the additional settings available. After you configure the Pro:Centric settings, you will have the option to exit without completing the remainder of the EZ-Manager Wizard or Express Script (as applicable), if desired.

Note: If you exit the First Use Wizard from this Welcome screen, no configuration will be performed and all Installer Menu items will retain their default values, including Installer Menu item 119 DATA CHANNEL. The default DATA CHANNEL setting (255) means that the Pro:Centric remote management feature on this TV will be activated if a Pro:Centric server is installed and the Data Channel value is set during a Data Channel Auto Search (see item 119 description on page 53 for additional information). If you actually would like to disable the Pro:Centric feature, both the EZ-Manager Wizard and the Express Script provide an option to do so.

Initiate the EZ-Manager Wizard

After you select the “EZ-Manager” option from the First Use Wizard Welcome screen, an EZ-Manager Welcome screen provides a brief introduction to the EZ-Manager Wizard.

Note: Each EZ-Manager Wizard step is allotted a time frame after which the wizard proceeds without user interaction. If the Pro:Centric server is configured on the system and if no location-specific settings are required in the TV, for example, TV Zone, Wi-Fi Zone, Label, and/or Room Number settings, from this point, the wizard can proceed through each of the configuration steps with no further user interaction.

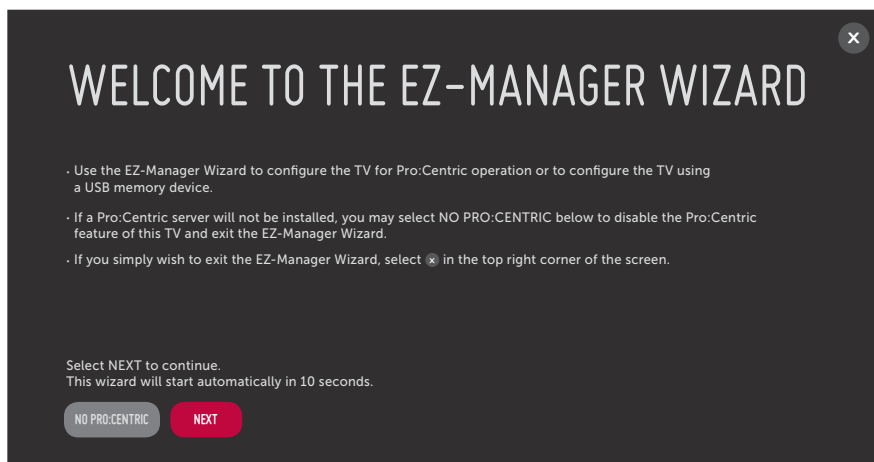

Note: If there is no user action in this screen within 10 seconds, the wizard will proceed to the next configuration step. Once the wizard has proceeded, it is not possible to return to the EZ-Manager Welcome screen; however, if you simply wish to exit the wizard, you can do so by selecting the **X** button from the subsequent screen(s).

From the EZ-Manager Welcome screen, you have the following options:

- To proceed with the EZ-Manager Wizard, use the arrow keys on the Installer Remote to select **NEXT**, and then press **OK**. Then, continue to the “TV Configuration Options” section on the following page.
- To exit the EZ-Manager Wizard, but retain the use of the Pro:Centric remote management feature on this TV (i.e., Installer Menu item 119 DATA CHANNEL set to 255) in the future, use the arrow keys on the Installer Remote to select/highlight the **X** button, and then press **OK**. In the confirmation pop-up window, select **EXIT**, and then press **OK** once more on the Installer Remote.
- If you do not intend to install a Pro:Centric server on this system and you do not wish to use the wizard’s Zoning or USB configuration options, exit the wizard as follows: Use the arrow keys on the Installer Remote to select **NO PRO:CENTRIC**, and then press **OK**. This will disable the Pro:Centric feature of this TV (i.e., Installer Menu item 119 DATA CHANNEL will be set to 0) and exit the wizard. In the confirmation pop-up window, select **EXIT**, and then press **OK** once more on the Installer Remote.

EZ-Manager Wizard (Cont.)

TV Configuration Options

From the TV Configuration Options screen, you can choose how to proceed with the configuration of this TV (assuming you do not opt to exit the wizard, which you may also do at any time).



Note: If you intend to use the Zoning feature(s) on the TV for location-specific configuration purposes, select the “Zones & Room Number” option from this screen and set the appropriate TV Zone # and/or the Wi-Fi Zone # in the TV BEFORE you continue with additional configuration.

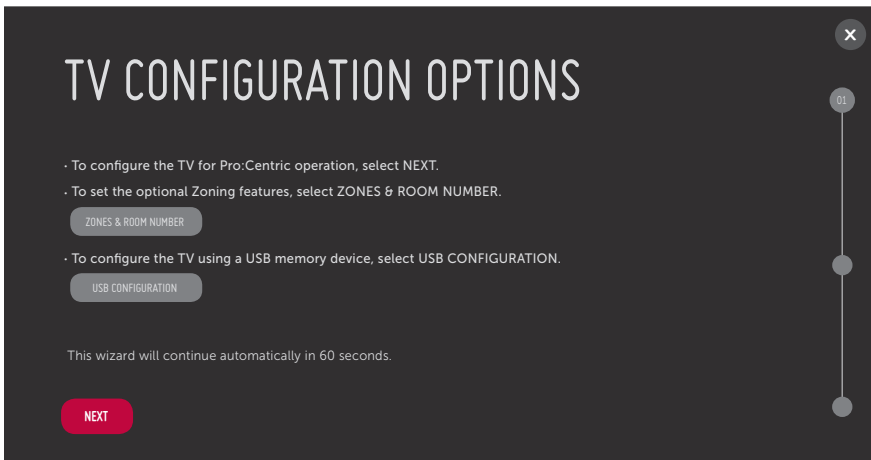

Note: If there is no user action in this screen within one minute, the wizard will automatically continue to the next configuration step.

Use the Left/Right arrow keys on the Installer Remote to navigate between options on this screen. Each time you select/highlight one of the following options, the screen text and fields will change in accordance with your selection.

- To continue with Pro:Centric configuration, select **NEXT** (default) and press **OK** on the Installer Remote. Refer to “Configure Pro:Centric Settings” on pages 22 to 26 for additional information.
- To set the Zoning feature(s) on the TV, select **ZONES & ROOM NUMBER**. See “Zones and Room Number Assignments” below for further information.
- To access the TV Manager / USB download options, select **USB CONFIGURATION**. See “USB Configuration” on pages 26 to 27 for further information.

Note: If you choose to exit the EZ-Manager Wizard from this point on, you will have the option to save any settings made by selecting **SAVE & EXIT** in the exit confirmation pop-up window. Or, you can exit the wizard without saving any settings by simply selecting **EXIT** in the confirmation pop-up window.

Zones and Room Number Assignments

You may complete one or more of the fields in the Zones, Label, and Room Number screen or leave them at their default settings (TV Zone and Wi-Fi Zone) or blank (Label and Room Number), as desired. However, if you intend to use either of the Zoning features—TV Zoning and/or Wi-Fi Zoning—on this TV, you **MUST** specify the appropriate values in the TV Zone and/or Wi-Fi Zone fields as described on the following page. See also Reference section, “Using the TV’s Zoning Features,” for further information.

Note: Zoning features are only applicable for TVs that will be configured using a “.tlx” file (local or remote configuration).

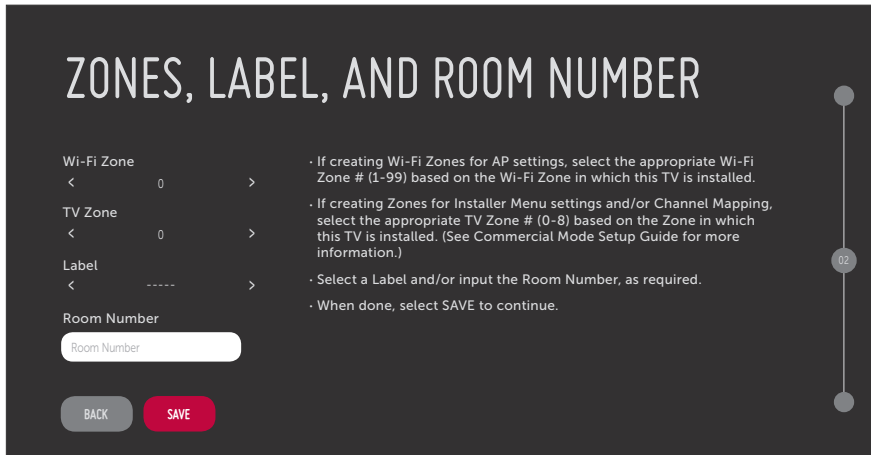

- Complete the appropriate field(s) as described below. Use the Up/Down arrow keys on the Installer Remote to navigate between each of the fields.
 - Wi-Fi Zone:** Enables you to set a Wi-Fi Zone # so that the TV can be configured with a particular access point’s login data for wireless networking. Login data (i.e., SSID, security type, and security key) may be provided in a Clone/Configuration (.tlx) file.
To assign a Wi-Fi Zone, navigate to the Wi-Fi Zone field at the top left of the screen, and use the Left/Right arrow keys to specify the desired Wi-Fi Zone # (1–99).
 - TV Zone:** Enables you to set a TV Zone # so that the TV can be configured with Installer Menu and/or Setup Menu settings intended only for the assigned Zone. The Installer Menu and/or Setup Menu settings may be provided in a Clone/Configuration (.tlx) file. If the TV is being configured for FTG Mode, the TV Zone # setting also allows the TV to omit channels that have been restricted in the FTG Channel Map.
To change the TV Zone from its default value (0), navigate to the TV Zone field, and use the Left/Right arrow keys to specify the desired TV Zone # (1–8).
 - Label:** Allows you to select a North, South, East, or West text label for this TV. In the Label field, use the Left/Right arrow keys to select the applicable label.
 - Room Number:** Allows you to specify the number of the room—up to 16 characters—in which the TV is located. To enter a room number, navigate to the Room Number field and press **OK**. You can then use the number keys on the Installer Remote to direct enter a room number, or you can use the arrow keys to select the appropriate alphanumeric character(s) from the pop-up virtual keyboard at the bottom of the screen. When you are done, select **Enter** from the virtual keyboard, and then press **OK** on the Installer Remote.
Note: The TV name (default: TV’s serial number) will be changed to the room number specified here. See “Media Share Setup” on pages 77 to 78 for further information on the TV name.
- When you are ready to continue, use the arrow keys to select **SAVE**, and then press **OK** on the Installer Remote to return to the TV Configuration Options screen. Then, proceed as required; i.e., select **NEXT** to configure Pro:Centric settings or select **USB CONFIGURATION** to use a USB memory device to complete the configuration.

EZ-Manager Wizard (Cont.)

Configure Pro:Centric Settings

Once you select “NEXT” from the TV Configuration Options screen, the Searching for Pro:Centric Server screen is displayed.

Note: Select the “BACK” button, where available, to check previous settings, as necessary. Also note that if any of the configuration steps fails, you will see a “Diagnostics” screen with an indication of the failure. You will then have the opportunity to reinitiate the configuration process from the previous screen or exit the EZ-Manager Wizard.

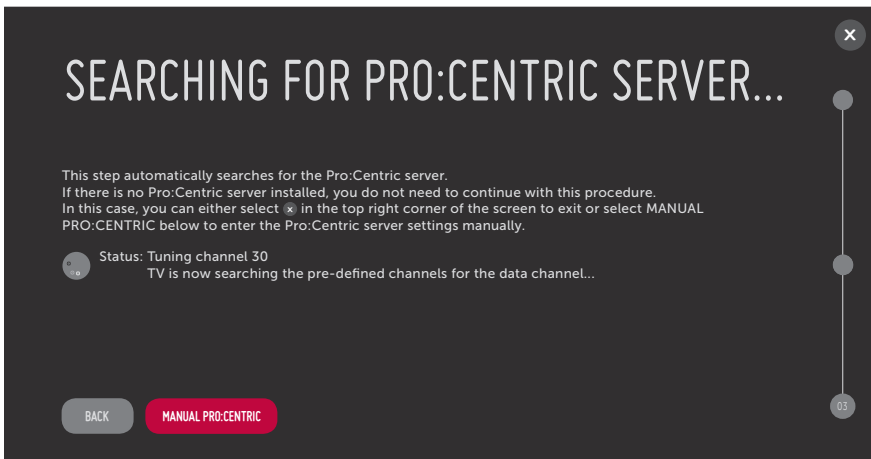

You have the following options:

- You can allow the EZ-Manager Wizard to proceed with a series of automated steps to configure the TV for Pro:Centric operation and then to look for the Pro:Centric application and maintenance (E-Z Installation) files to download. In this case, the wizard uses a search algorithm to determine the Data Channel and the Pro:Centric Application Mode to set in the TV.

Continue with the “Automated Pro:Centric Configuration” subsection below.

- If you already know the settings (e.g., Data Channel and Pro:Centric Application Mode) that need to be configured in order for the TV to connect to the Pro:Centric server and/or if the Pro:Centric server is not yet installed, you may expedite the setup process by entering this data manually.

Continue with the “Manual Pro:Centric Configuration” subsection on page 24.

Automated Pro:Centric Configuration

Note: If the server is not yet configured on the system, use the manual configuration option to configure the Pro:Centric operation. See also note below.

Note: If Pro:Centric data delivery will be over IP and there is a DNS server at the site, you can create a DNS entry “procentric.local” for the Pro:Centric server that will enable automated Pro:Centric IP configuration via the EZ-Manager. If there is no DNS entry for procentric.local, you must use the manual configuration option to configure the Pro:Centric IP operation.

Once the Pro:Centric data channel is found (a Pro:Centric Server Was Found screen will be displayed) and the Pro:Centric Application Mode is determined, the wizard will advance to the Processing the Pro:Centric Configuration screen, which shows the progress of the data downloads (see example on following page). Note that some steps may require a few minutes.

If the process is successful, no further user interaction is required, though, in some instances, where the option (for example, “NEXT”) is available, you may manually move forward to subsequent steps within the wizard to speed up the process.

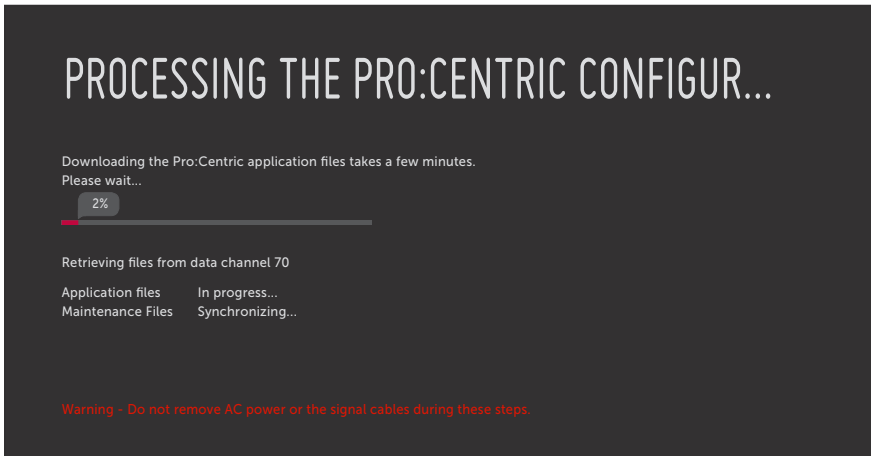

Note: If, after completing the search, the TV is unable to find the Pro:Centric data channel (while the Searching for Pro:Centric Server screen is on display), the wizard will stop and show a Diagnostics screen that enables you to manually return to the previous screen (to reinitiate the configuration) or exit the wizard.

When the Pro:Centric Configuration is complete, an EZ-Manager Configuration Complete screen is displayed (see example below), and after 10 seconds, the wizard exits, and the TV turns OFF.

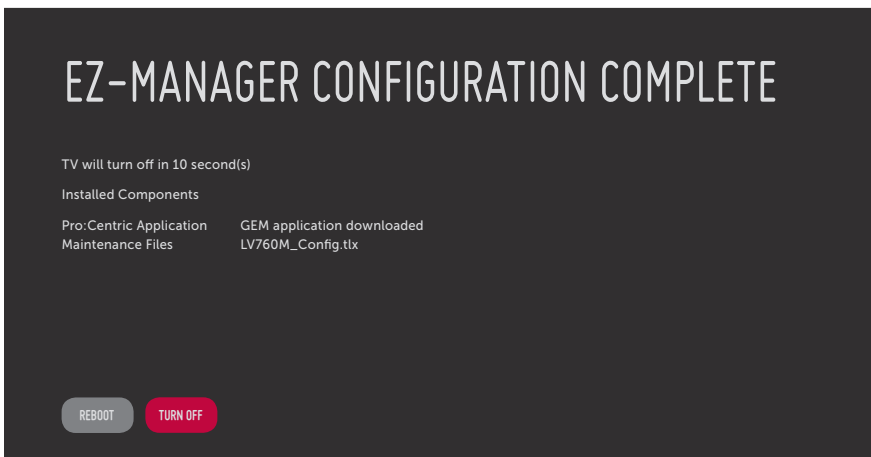

Note: With the EZ-Manager Configuration Complete screen on display, you can also manually turn off or reboot the TV. If desired, select **TURN OFF** or **REBOOT**, respectively, and then press **OK** on the Installer Remote.

EZ-Manager Wizard (Cont.)

Manual Pro:Centric Configuration

1. With the Searching for Pro:Centric Server screen on display, use the Left/Right arrow keys on the Installer Remote to select **MANUAL PRO:CENTRIC** at the bottom of the screen, and then press **OK**.

In the Pro:Centric Manual Configuration screen (see examples below), you will be able to configure the appropriate Pro:Centric settings in the TV. Use the Up/Down arrow keys on the Installer Remote to navigate between fields.

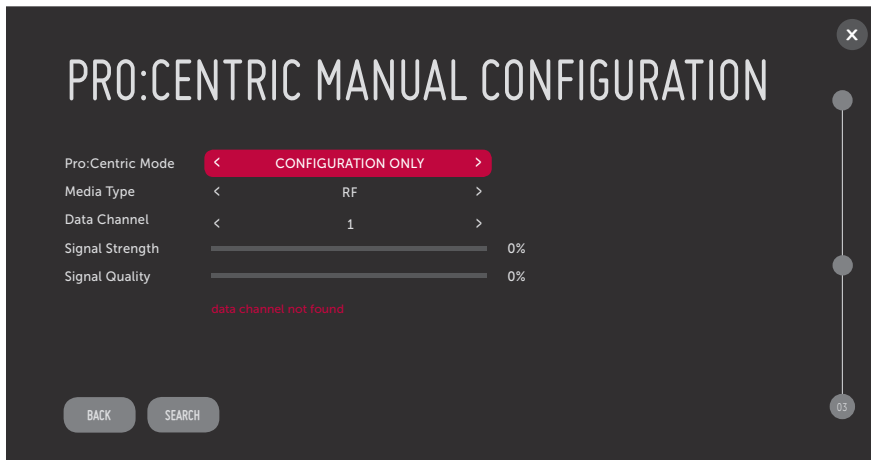

Pro:Centric Manual Configuration Screen with RF Media Fields

Note: By default, the Pro:Centric Manual Configuration screen initially shows RF configuration fields.

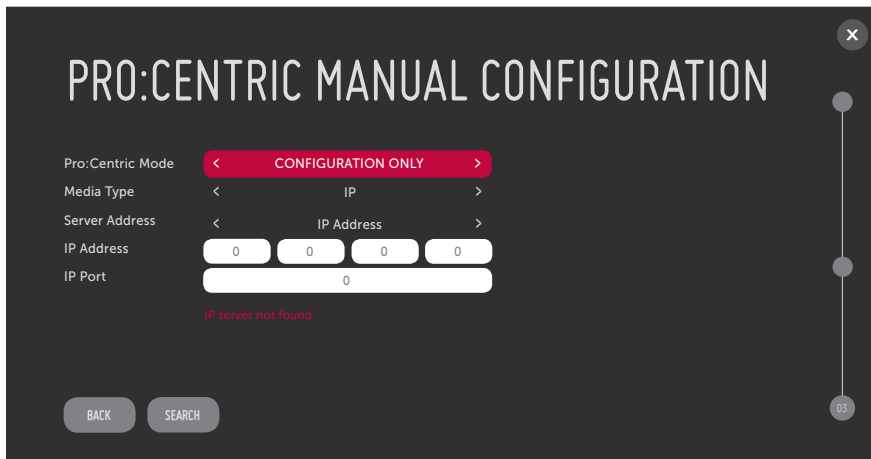

Pro:Centric Manual Configuration Screen with IP Media Fields

2. In the Pro:Centric Mode field, use the Left/Right arrow keys to select the appropriate Pro:Centric Application Mode—FLASH, GEM, HTML, or CONFIGURATION ONLY.

Note: For remote management only, select **CONFIGURATION ONLY**. The TV will search for TV E-Z Installation data downloads; however, Pro:Centric application data will not be downloaded, i.e., Installer Menu item 098 PRO:CENTRIC will be set to 0.

3. Refer to the appropriate subsection below, depending on the Pro:Centric server configuration, to complete the remaining fields.

(Continued on next page)

(Continued from previous page)

RF Configuration

- a) In the Media Type field, use the Left/Right arrow keys to select **RF**.
- b) In the Data Channel field, use the Left/Right arrow keys to select the RF channel number that will be used by the Pro:Centric server as its data channel. The Data Channel value can be set from 1 to 135.*

IP Configuration

- a) In the Media Type field, use the Left/Right arrow keys to select **IP**.
Note: When you select “IP” as the Media Type, the default RF Data Channel and Signal Strength/Quality fields are replaced with Server Address, IP Address, and IP Port fields.
- b) The Server Address field provides the option to specify the domain name of the Pro:Centric server instead of the server’s IP address. Use the Left/Right arrow keys to select the desired option—IP Address or Domain Name—for defining the server.
- c) Depending on your selection in the previous step, either:
 - Enter the Pro:Centric server IP address in the IP Address field. The IP address must match the IPv4 multicast address that is set in the Pro:Centric server.
 - Enter the Pro:Centric server domain name in the Domain Name field. Note that in order for the domain name to be resolved to an IP address, there must be a DNS entry for the domain name.

For each data entry field: Use the arrow keys to select the field and press **OK**. Then, you can either use the number keys on the Installer Remote to direct enter data values, or you can use the arrow keys to select the appropriate number(s)/alphanumeric character(s) from the pop-up virtual keyboard displayed at the bottom of the screen. When you are done, select **Enter** from the virtual keyboard, and then press **OK** on the Installer Remote.

- d) Enter the Pro:Centric server port number in the IP Port field. The port number must match the port number that is set in the Pro:Centric server.
4. Once all fields are completed as required, you have two options:
- To save the data entered and exit the wizard, use the arrow keys to select the **✕** button at the top right of the screen, and then press **OK**. In the subsequent pop-up confirmation window, select **SAVE & EXIT**, and then press **OK** once more. The Pro:Centric application and/or E-Z Installation data will be downloaded to the TV at a later time. This option is useful, in particular, if the Pro:Centric server has not yet been configured.
 - To initiate a real-time download of Pro:Centric application and/or E-Z Installation data, use the arrow keys to select **SEARCH** and press **OK** to verify the configuration data provided in step 3. When the data is verified, the “SEARCH” button becomes a “NEXT” button. Select **NEXT** and press **OK** to continue (see also note below).

Note: With RF configuration, Pro:Centric server data must be present on the RF channel selected as the TV’s Data Channel in order for you to select “NEXT” (you will see a “data channel found” message below the Signal Quality indicator). With IP configuration, Pro:Centric server data must be present via the wired LAN cable connection in order for you to select “NEXT” (you will see a “IP server found” message below the IP Port field).

(Continued on next page)

* PCS150R and later Pro:Centric servers do not support HRC or IRC cable channel frequencies.

EZ-Manager Wizard (Cont.)

(Continued from previous page)

If you opt to initiate a real-time download in the last step, the EZ-Manager Wizard will proceed with the Pro:Centric application and/or E-Z Installation data downloads (see Processing the Pro:Centric Configuration screen example on page 23). When the Pro:Centric configuration is complete, an EZ-Manager Configuration Complete screen (see example on page 23) is displayed, and after 10 seconds, the wizard exits, and the TV turns OFF.

Note: With the EZ-Manager Configuration Complete screen on display, you can also manually turn off or reboot the TV. If desired, select **TURN OFF** or **REBOOT**, respectively, and then press **OK** on the Installer Remote.

USB Configuration

TV Manager / USB download options enable you to download configuration or software files individually from a USB memory device to the TV. You can also use the Ez Download utility available from the menu to select multiple types of files to be downloaded at one time using one process.

Each of the USB download functions requires that you have the appropriate file(s) loaded on a USB memory device. If you wish to perform a software update or download splash screen/background image files, the software update/image file(s) must be stored in a folder named "LG_DTV" in the root directory of the USB memory device. Clone/Configuration (.tlx) files should simply be stored in the root directory of the USB device.

The procedure below assumes the desired file(s) is/are already loaded onto the USB device. For further information on the TV Manager / USB download options and file requirements, and/or for information on creating Clone/Configuration (.tlx) files, refer to the appropriate section(s) in this document.

Before You Begin

- If you intend to use the Zoning feature(s) on this TV, make sure to set the appropriate TV Zone # and/or Wi-Fi Zone # in the EZ-Manager's Zones, Label, and Room Number screen BEFORE continuing with USB Configuration. See "TV Configuration Options" on page 20 for further information.
- Ensure the USB device to be used has been formatted with FAT format.
- When creating files to be downloaded, avoid using special characters (?, &, @, etc.) in filenames.
- Refer to "Ez Download Utility" on pages 39 to 42 for further information on the Ez Download utility.
- Refer to "Custom Master TV Setup" on pages 54 to 56 for information on creating a Clone (.tlx) file, and/or refer to "Creating an FTG Configuration File" on pages 63 to 65 for information on creating an FTG Configuration (.tlx) file for FTG Mode configuration.
- See Reference section, "Downloading a Splash Screen Image using a USB Memory Device," for splash screen image guidelines.
- See Reference section, "Downloading Background Images using a USB Memory Device," for background image guidelines.
- See Reference section, "Updating TV/PTC Software using a USB Memory Device," for further information on software updates.

USB Configuration via EZ-Manager Wizard

With either the TV Configuration Options or the Zones, Label, and Room Number screen on display, proceed as follows to configure the TV using the USB memory device.

1. Insert the USB memory device with the appropriate file(s) into the TV's USB port.
2. Use the arrow keys on the Installer Remote to select **USB CONFIGURATION**, and then press **OK**.

You will be redirected to the TV Manager / USB download options.

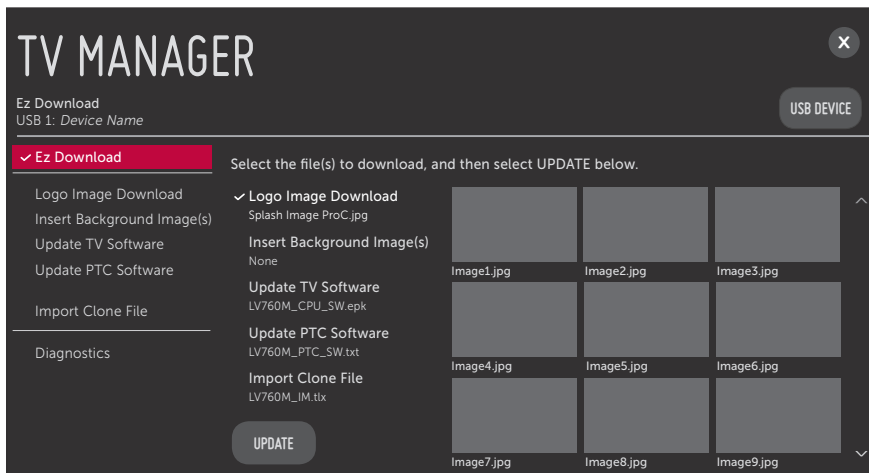

Note: You can select the **X** button at the top right corner of the screen and press **OK** on the Installer Remote at any time to return to the EZ-Manager Wizard.

Note: Ez Download is always selected by default when you initially access the TV Manager. Also note that Diagnostics is for service use only.

3. Select the appropriate option from the TV Manager, and initiate the desired download(s).

Update progress will be displayed on the screen. Do NOT remove the USB device while updates are in progress. When the update process is complete, the TV will reboot. Upon restart, depending on the type of update(s) completed, either the EZ-Manager TV Configuration Options screen will be redisplayed (software and/or image updates only) or the TV will tune according to the Start Channel setting in the Installer Menu (TV configured with Clone/Configuration file).

Note: If the TV Configuration Options screen is redisplayed (software and/or image updates only), you can either proceed with configuration via the EZ-Manager Wizard or exit the EZ-Manager Wizard, as required.

4. Remove the USB memory device, and verify that the appropriate configuration/update(s) is/are resident on the TV.

Express Script

Initiate the Express Script

Note: The Express Script configures the TV for FTG Mode via CPU operation with Hospital Mode features. This means that while the TV is functioning in FTG Mode, Hospital Mode is enabled (i.e., Installer Menu item 027 HOSPITAL MODE is not set to 0). In addition, you can create custom channel lineups for Channel Banks 1 to 4.

Note: While the Express Script enables you to set up TVs individually in lieu of cloning, you can also use the resulting Express Script TV Setup for cloning purposes, if desired. However, note that TV setup menu customization via the Express Script is limited to Channels Menu options.

After you select the “Express Script” option from the First Use Wizard Welcome screen, an Express Script Welcome screen provides a brief introduction to the Express Script.



From the Express Script Welcome screen, you have the following options:

- To proceed with the Express Script, use the arrow keys on the Installer Remote to select **NEXT**. Then, press **OK** on the Installer Remote.

Note: Select this option even if you only intend to configure the Pro:Centric settings on this TV. After you configure the Pro:Centric settings, you will have the option to exit without completing the remainder of the wizard, if desired.

- To exit the Express Script without completing any configuration, use the arrow keys on the Installer Remote to select/highlight the **[X]** button, and then press **OK**. In the confirmation pop-up window, select **EXIT**, and then press **OK** once more on the Installer Remote.

Configure Pro:Centric Settings

The next screen enables you to set up the Pro:Centric feature of the TV (see screen examples below). By default, the Data Channel is configured for Auto Search, which enables the TV’s Data Channel Auto Search feature to set the Data Channel value. See item 119 DATA CHANNEL description on page 53 for further information on the Data Channel Auto Search feature. The Pro:Centric Application Mode default setting is “Configuration Only,” which enables remote management only. That is, the TV will search for TV E-Z Installation data downloads; however, Pro:Centric application data will not be downloaded, i.e., Installer Menu item 098 PRO:CENTRIC will be set to 0.

(Continued on next page)

(Continued from previous page)

If you wish to proceed with the wizard without changing the default values for the Pro:Centric settings, you can simply select **NEXT** and press **OK** on the Installer Remote. Or, if you wish to exit the wizard while retaining the default values for Pro:Centric settings, use the arrow keys on the Installer Remote to select **DONE**, and then press **OK**.

If you already know the Pro:Centric settings that need to be configured in order for the TV to connect to the Pro:Centric server and/or if the Pro:Centric server is not yet installed, use the procedure on the following page to expedite the setup process. Use the Up/Down arrow keys on the Installer Remote to navigate between the fields.

Note: If you wish to disable the Pro:Centric feature of the TV, select the Data Channel field, and then use the Left/Right arrow keys on the Installer Remote to select **DISABLED**. From here, you may opt to proceed with the wizard (select **NEXT**) or save this setting and exit the wizard (select **DONE**). See also step 3 below.

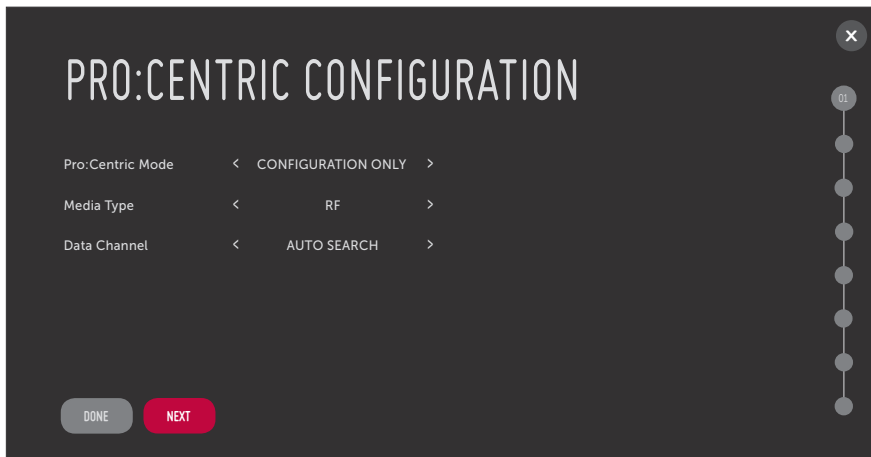

Pro:Centric Configuration Screen with RF Media Fields

Note: By default, the Pro:Centric Configuration screen initially shows RF configuration fields.

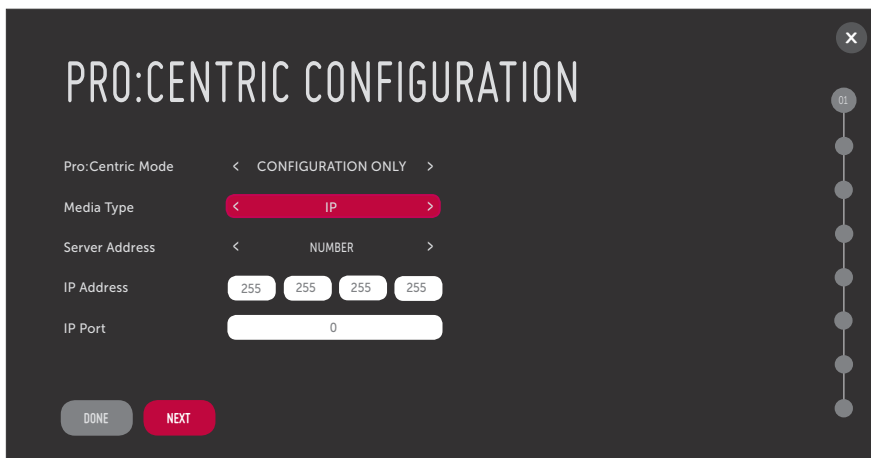

Pro:Centric Configuration Screen with IP Media Fields

(Continued on next page)

Express Script (Cont.)

(Continued from previous page)

1. In the Pro:Centric Mode field, use the Left/Right arrow keys on the Installer Remote to select the appropriate Pro:Centric Application Mode—FLASH, GEM, HTML, or CONFIGURATION ONLY.

Note: For remote management only, select **CONFIGURATION ONLY**. The TV will search for TV E-Z Installation data downloads; however, Pro:Centric application data will not be downloaded, i.e., Installer Menu item 098 PRO:CENTRIC will be set to 0.

2. Refer to the appropriate subsection below, depending on the Pro:Centric server configuration, to complete the remaining fields.

RF Configuration

- a) In the Media Type field, use the Left/Right arrow keys on the Installer Remote to select **RF**.
- b) In the Data Channel field, use the Left/Right arrow keys to select the RF channel number that will be used by the Pro:Centric server as its data channel. The Data Channel value can be set from 1 to 135.*

IP Configuration

- a) In the Media Type field, use the Left/Right arrow keys on the Installer Remote to select **IP**.
Note: When you select “IP” as the Media Type, the default RF Data Channel field is replaced with Server Address, IP Address, and IP Port fields.
- b) The Server Address field provides the option to specify the domain name of the Pro:Centric server instead of the server’s IP address. Use the Left/Right arrow keys to select the desired option—NUMBER or DOMAIN—for defining the server.
- c) Depending on your selection in the previous step, either:
 - Enter the Pro:Centric server IP address in the IP Address field. The IP address must match the IPv4 multicast address that is set in the Pro:Centric server.
 - Enter the Pro:Centric server domain name in the Domain Name field. Note that in order for the domain name to be resolved to an IP address, there must be a DNS entry for the domain name.

For each data entry field: Use the arrow keys to select the field and press **OK**. Then, you can either use the number keys on the Installer Remote to direct enter data values, or you can use the arrow keys to select the appropriate number(s)/alphanumeric character(s) from the pop-up virtual keyboard displayed at the bottom of the screen. When you are done, select **Enter** from the virtual keyboard, and then press **OK** on the Installer Remote.

- d) Enter the Pro:Centric server port number in the IP Port field. The port number must match the port number that is set in the Pro:Centric server.

(Continued on next page)

* PCS150R and later Pro:Centric servers do not support HRC or IRC cable channel frequencies.

(Continued from previous page)

- Once all fields are completed as required, you have two options:
 - To proceed with TV configuration via the Express Script, select **NEXT** and press **OK** on the Installer Remote. Continue to “Complete the TV Configuration” on the following page.
 - To save the data entered and exit the Express Script, use the arrow keys to select **DONE** and then press **OK** on the Installer Remote. Remember, however, that if you do not complete the Express Script, pillow speaker functionality will not be enabled unless you set Installer Menu item 027 HOSPITAL MODE appropriately. See the “Installer Menu” section of this document for further information.

Complete the TV Configuration

The following procedure describes the remaining steps in the Express Script. You can select the “BACK” button, where available, to check previous settings, as necessary. Typically, if you do not modify the default settings, the “NEXT” button is automatically selected when you proceed forward within the Express Script. Where appropriate, you can simply press **OK** on the Installer Remote to proceed to the next step if the default value(s) for the TV parameter(s) in question are applicable for your installation.

 **Note: If you choose to exit the Express Script from this point on, any settings made will not be retained.**

- In the Select the Tuning Band screen, use the Up/Down arrow keys on the Installer Remote to highlight/select the appropriate tuning band option: Cable Standard (default), Cable HRC, Cable IRC, or Air. Then, press **OK**. When you have made your selection, use the arrow keys to select **NEXT**, and then press **OK**.

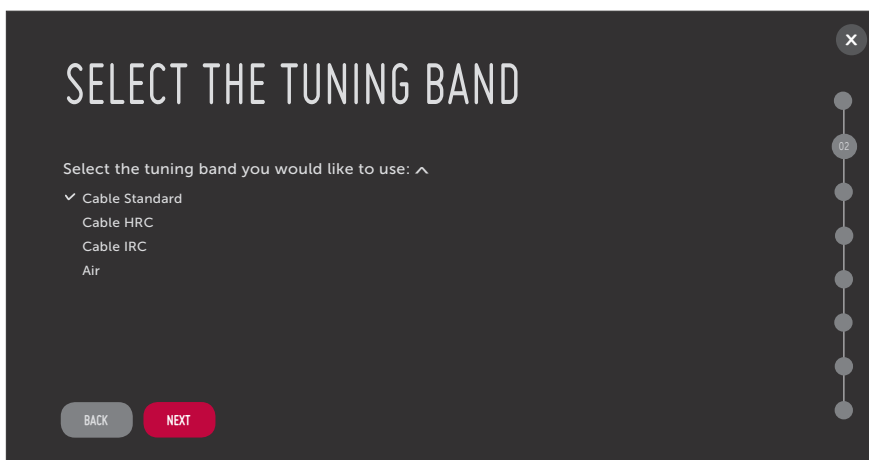

- By default, all Aux inputs are enabled, as shown initially in the Enable/Disable Aux Inputs screen. To disable an Aux input, use the arrow keys on the Installer Remote to select the desired input, and then press **OK** to toggle the status of the Aux input.

(Continued on next page)

Express Script (Cont.)

(Continued from previous page)

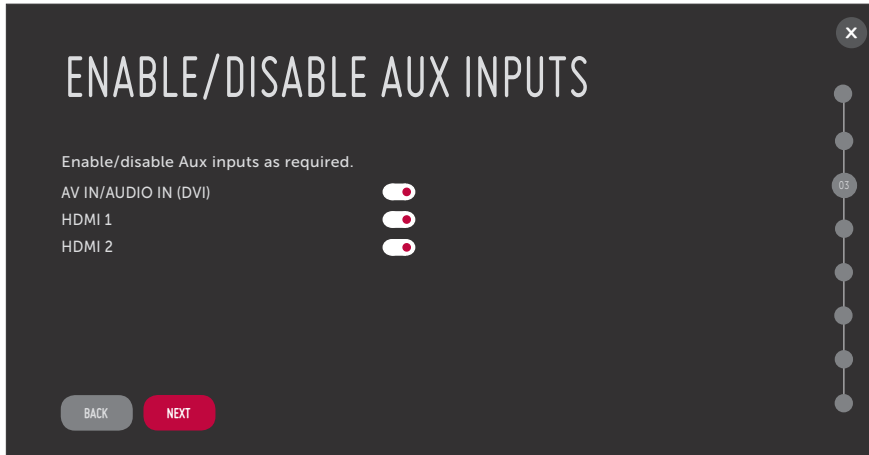

Enabled Aux inputs are included in the channel lineup. If an Aux input will not be used, it is typically advisable to disable it, though you may also simply delete it from the channel lineup in step 5, if you want to leave it enabled in the Installer Menu. When you are ready to continue, use the arrow keys to select **NEXT**, and then press **OK**.

Note: After the TV setup is complete (see step 7), the only way to add or remove Aux inputs to/from the FTG Channel Map, is to edit the FTG Channel Map using the Cloud Configuration Tool. See the [Cloud Configuration Tool / Channel Map web page overview](#) on page 67, and/or refer to the *Cloud Configuration Tool User Guide* for further information.

Note: Disabled Aux inputs are not included in the channel lineup. However, if you wish to enable a disabled Aux input in the future, you may do so by changing the applicable Installer Menu settings (see Installer Menu information in this document). See also note above.

3. In the Speaker Selection screen, you will be able to select the speaker configuration for the TV. This selection sets Installer Menu item 027 HOSPITAL MODE, which also means that when the Express Script is complete, the TV will be operating in FTG Mode via CPU with Hospital Mode features enabled. See item 027 description on page 49 for further information.

Use the arrow keys on the Installer Remote to select the appropriate speaker configuration:

- Highlight/select the desired speaker: Pillow Only (default), TV Only, or Pillow & TV. Then, press **OK**.
- If applicable, select the pillow speaker code/voltage and press **OK**.

Note: If using a Pro:Centric pillow speaker (LG IR codes) or a pillow speaker with Zenith IR codes, make sure the “Zenith” pillow speaker code (default) is selected.

When you have made your selection(s), use the arrow keys to select **NEXT**, and then press **OK**.

(Continued on next page)

(Continued from previous page)

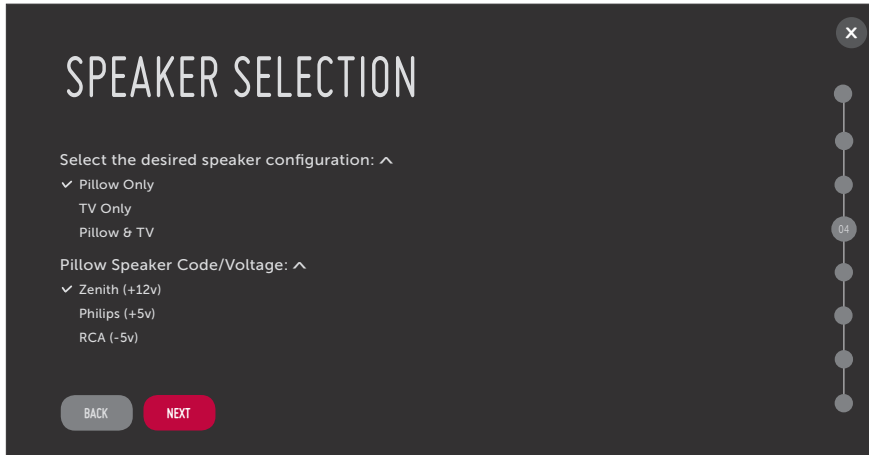

4. In the Channel Tuning screen, you have the option to initiate an automated channel scan that will search for all available digital and analog channels. Select **RUN AUTO TUNING** and press **OK** on the Installer Remote to start the channel scan.



Note: You **MUST** select **RUN AUTO TUNING** and press **OK** in order to run the channel scan. If you move on to the next step without running Auto Tuning, there will be no digital or analog channels in the channel lineup. In this case, upon completion of the Express Script, the only channels in the resulting FTG Channel Map will be any enabled Aux inputs.

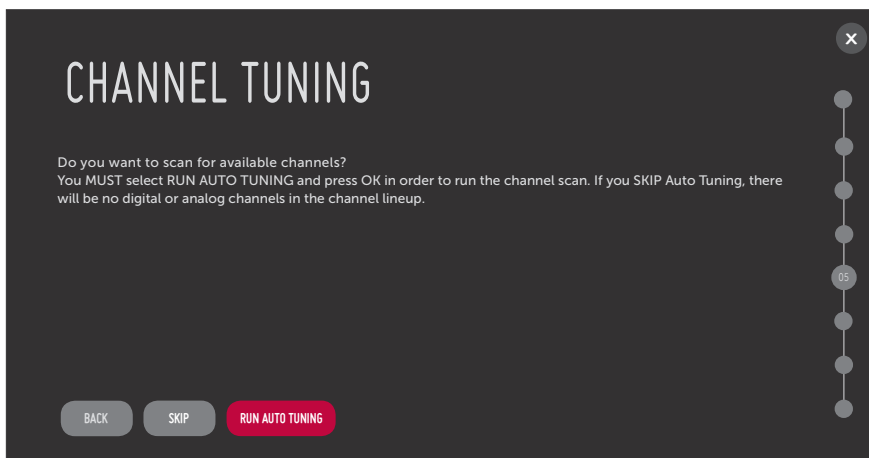

Auto Tuning progress will be shown in a new Channel Tuning screen. The scan typically takes a few minutes. When the channel scan is complete, the Express Script will automatically advance to the Edit the Channel Lineup screen. Continue with step 5.

Note: If you do not want to run Auto Tuning, use the arrow keys on the Installer Remote to select **SKIP** and press **OK**.

(Continued on next page)

Express Script (Cont.)

(Continued from previous page)

5. In the Edit the Channel Lineup screen, you can customize the channel lineup, add channel labels and icons, etc. before the channel lineup is used to create an FTG Channel Map in step 7. You can also set up channel banks in this screen.

Note: The total number of channels found (“Searched”) during Auto Tuning is indicated at the top left of the display.

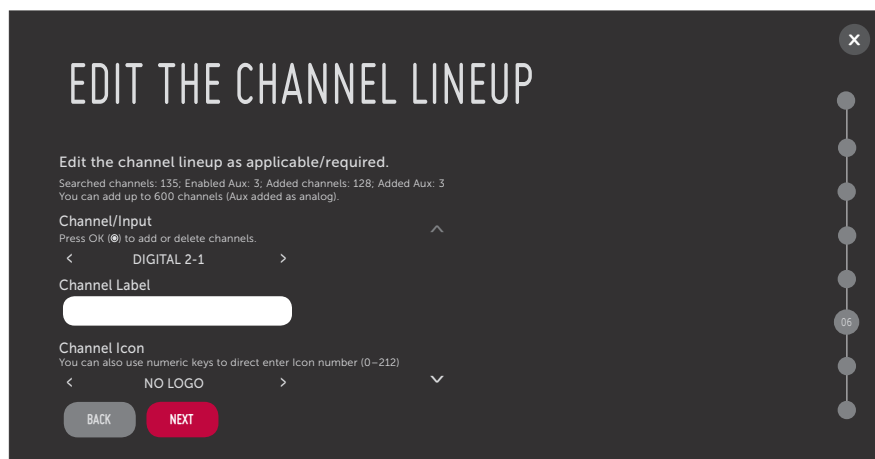

Note: If, for any reason, you elect to re-run Auto Tuning after customizing channels in the Edit the Channel Lineup screen, your current custom channel settings will be lost, and you will need to replicate the desired customization.

Use the arrow keys to navigate between the fields in this screen:

- Channel/Input: Edit the channel lineup, as necessary. Use the Left/Right arrow keys on the Installer Remote to select channels (including Aux inputs), and press **OK** to delete (or re-add) channels per the installation site requirements.

Note: When a channel is active in the channel lineup (i.e., added), all additional fields in this screen are selectable/available. If a channel is deleted, all other fields in this screen become inaccessible (grayed out).

- Channel Label: Press **OK** to display the pop-up virtual alphanumeric keyboard, and add a custom text label for each channel/Aux input (up to 17 characters), as desired.
- Channel Icon: This field enables you to select the appropriate trademark/icon for each channel's Channel-Time on-screen display. If known, you can direct enter the icon number using the number keys on the Installer Remote. Otherwise, use the arrow keys on the Installer Remote to select/highlight either the left (<) or right (>) arrow in the Channel Icon field, and press **OK** until the desired logo is shown. Icons are available for familiar channels, such as ABC, CBS, NBC, etc. Identifiable icons should enable the end user to readily know what common networks are available.

(Continued on next page)

(Continued from previous page)

- Channel Banks: All channels found during Auto Tuning automatically are added to and active in all four channel banks. Use the arrow keys to define channel banks, as desired. See “Channel Banks Overview” on following page for additional information.

Note: Channel Banks fields are below the Channel Icon field. Use the Up/Down arrow keys on the Installer Remote to scroll through all fields. See also example in “Channel Banks Overview” section.

When you are finished, use the arrow keys to select **NEXT**, and then press **OK**.

6. In the Channel Tuning/Channel Banner screen, use the Up/Down arrow keys on the Installer Remote to highlight/select the appropriate channel tuning/channel banner display format option—either Logical (default) or Physical—for the installation site. When you have made your selection, use the arrow keys to select **NEXT**, and then press **OK**.

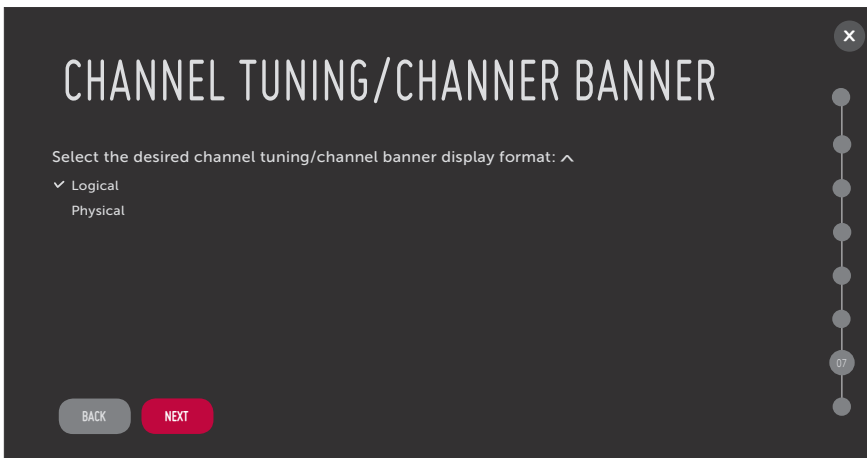

7. As the final step of the Express Script, the TV saves your settings and uses the channel/Aux input lineup to create an FTG Channel Map before configuring the TV for FTG Mode via CPU (see also notes below). When you are ready to proceed, select **FINISH**, and then press **OK**.

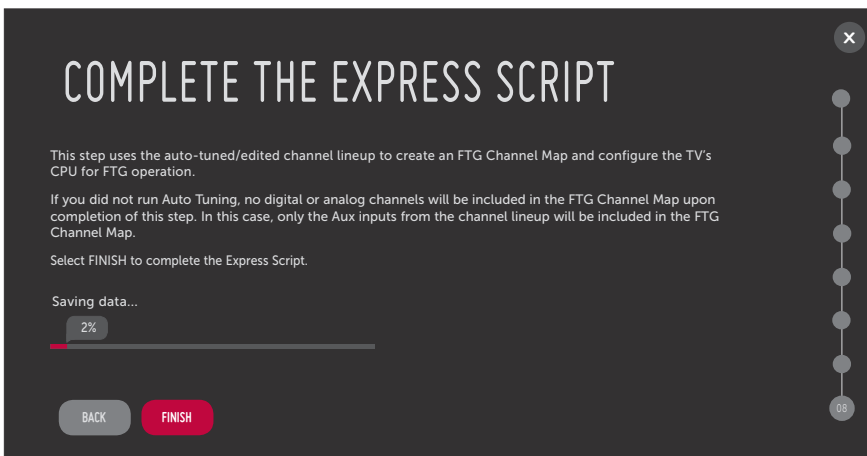

(Continued on next page)

Express Script (Cont.)

(Continued from previous page)

Configuration progress will be shown at the bottom of the screen. When this step is complete, the Express Script exits, and the TV tunes to the first channel in the FTG Channel Map. Also when the Express Script is complete, the TV is set for Channel Bank 1. If required, you can set up/modify channel banks at a later time using LG's Cloud Configuration Tool. See "Channel Banks Overview" below for further information.

Note: If desired, the TV Setup created from the Express Script may also be saved to a USB memory device and used for cloning purposes (see "Cloning Procedures" on pages 50 to 56 for further information).

Note: Aux inputs (if enabled) will appear between the highest analog and lowest digital channel number in the FTG Channel Map when Channel Up/Down is used on the Installer Remote.

Note: If you did not run Auto Tuning and all Aux inputs are disabled, an FTG Channel Map will NOT be created and the TV will not be configured for FTG Mode.

Channel Banks Overview

Channel banks enable institution administrators to create tiered channel programming on patient in-room TVs. Each channel bank may offer a custom channel lineup for a pre-determined fee. The Express Script enables you to configure four channel banks (1, 2, 3, and 4) for the channel lineup (see step 5 of procedure above and also example below). The top tier generally contains the most programming (premium, etc.), 2nd tier = lesser programming, 3rd tier = basic programming, etc. It is also possible to create an Inactive TV display with Channel Bank 4, so that an "Inactive TV Call Attendant" message appears when the TV is turned ON. In this case, an administrator can then select another channel bank on the patient's in-room TV depending on the programming tier requested by the patient.

All channels found during Auto Tuning automatically are added to and active in all four channel banks. See "Channel Attributes and Channel Bank Allocation" below for further information. If you would like to modify channel banks after completing the Express Script (or after enabling Hospital Mode by setting Installer Menu item 027 accordingly), you can save (export) the FTG Channel Map to a USB memory device and then use the Cloud Configuration Tool to make the required changes (see also "Updating Channel Attributes and/or Channel Bank Allocation" below).

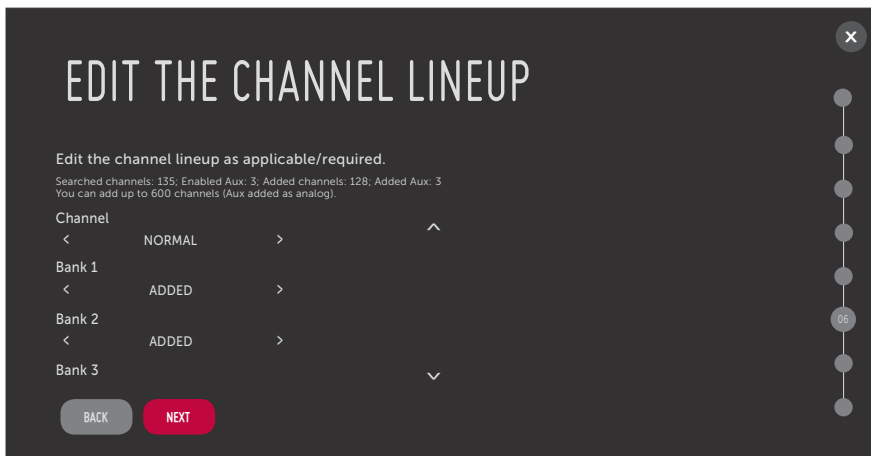

Channel Attributes and Channel Bank Allocation

Three attributes are available for each channel: Encrypted, OSD, and Blank Video. When the TV creates an FTG Channel Map upon completion of the Express Script, the OSD attribute (displays the channel number, label, and icon) is automatically assigned to all channels, and the Encrypted attribute is assigned to each Pro:Idiom encrypted channel detected during the channel scan. The Blank Video attribute is not assigned automatically to any channels; however, in the “Edit the Channel Lineup” screen of the Express Script, you have the option to assign the Blank Video (i.e., “BLANK”) attribute to channels, as required. When you assign the BLANK attribute to a channel (as opposed to the default “NORMAL”), this means that the channel audio will be audible; however, its video will be black (no picture). The NORMAL or BLANK attribute applies to the channel regardless of channel bank allocation.

Once you have set a channel’s NORMAL/BLANK attribute, determine the channel bank allocation for each of the four available channel banks: ADDED or DELETED. When DELETED, the channel will not appear in the channel lineup of the currently selected channel bank.

Selecting a Channel Bank

To select a channel bank, press **CH. BANK** on the Installer Remote. The first time you press the CH. BANK key, the TV display will show the currently active channel bank (default = Channel Bank 1). Each successive CH. BANK key press selects channel banks numerically, i.e., from Channel Bank 1 to Channel Bank 4. Press **CH. BANK** repeatedly until the desired channel bank is selected.

Updating Channel Attributes and/or Channel Bank Allocation

If you would like to modify channel attributes and/or channel bank allocation and/or update the FTG Channel Map in general, you can save (export) the FTG Channel Map to a USB memory device (see “Exporting a Clone File” on pages 57 to 59) and then use the Cloud Configuration Tool / Channel Map web page to make the required changes. On the Channel Map web page, Zones 1 to 4 are used to create custom channel lineups for Channel Banks 1 to 4. A checked Zone Restriction (1 to 4) checkbox means that the selected channel is “deleted” from the same numbered channel bank. Refer to the Channel Map web page overview on page 67 and also the **Cloud Configuration Tool User Guide** for further information. The Cloud Configuration Tool is available at: cct.procentric.tv.

Note: Hospital Mode channel banks and Lodging TV Zoning are mutually exclusive features of these TV models. If you wish to use channel banks, do not change the TV Zone # during the TV setup, as the TV Zone # will be used to track channel banks (banks are selected after configuration using the CH. BANK key on the remote as described above). If it becomes necessary to import a “.tlx” file with Installer Menu updates, in order to ensure that the Installer Menu settings are accepted by all LV760M TVs regardless of their current channel bank, you must also ensure that the new Installer Menu profile has a Zone 0 assignment. For additional information on TV Zoning, see Reference section, “Using the TV’s Zoning Features.”

Inactive TV Setup

To create an inactive TV display on Channel Bank 4, you need to modify the channel bank allocation for each channel in Channel Bank 4 to DELETED. You can do this in the Express Script, or you can use the Cloud Configuration Tool, as indicated above, to make changes.

Express Script (Cont.)

When the TV is turned ON by the patient, an “Inactive TV Call Attendant” message will appear on the screen, and after a few moments the TV will turn itself OFF. This will prompt the patient to arrange for an available programming package on Channel Bank 1, 2, or 3. Using the Installer Remote, the administrator can select Channel Bank 1, 2, or 3 depending on the entertainment programming tier selected by the patient. When the patient leaves the hospital, the administrator can then select Channel Bank 4 to reinstate the “Inactive TV” message.

The Ez Download utility, available from the TV Manager, enables you to select multiple files at one time from the files loaded on a USB memory device. You may use this utility to download any one or all of the following to a TV:

- One Clone or FTG Configuration (.tlx) file
- One TV CPU software update
- One PTC software update
- One splash screen image
- Up to 12 background images

Before You Begin

- Ensure the USB device has been formatted with FAT format.
- Software update and splash screen image files must be stored in a folder named “LG_DTV” in the root directory of the USB memory device. Clone/Configuration (.tlx) files should simply be stored in the root directory of the USB device.
- If you have initiated the EZ-Manager Wizard, you can use the wizard’s “USB Configuration” option to access the Ez Download utility, if desired (see “TV Configuration Options” and/or “USB Configuration” on pages 20 and 26, respectively, as necessary).
- If the TV is currently in Pass-through Mode and you intend to use the Zoning feature(s) on this TV for location-specific configuration purposes, make sure to set the appropriate TV Zone # and/or Wi-Fi Zone # in the TV when directed to do so in the procedure below.
- When creating files to be downloaded, avoid using special characters (?, &, @, etc.) in filenames.
- Refer to “Custom Master TV Setup” on pages 54 to 56 for information on creating a Clone (.tlx) file, and/or refer to “Creating an FTG Configuration File” on pages 63 to 65 for information on creating an FTG Configuration (.tlx) file for FTG Mode configuration.
- See Reference section, “Downloading a Splash Screen Image using a USB Memory Device,” for splash screen image guidelines.
- See Reference section, “Downloading Background Images using a USB Memory Device,” for background image guidelines.
- See Reference section, “Updating TV/PTC Software using a USB Memory Device,” for further information on software updates.



Caution: Do not unplug the TV power cord or remove the USB memory device during a data download, as doing so may cause the TV to malfunction or harm the USB device, respectively.

Accessing and Using the Ez Download Utility

1. If it is not ON already, turn ON the TV.
2. The next step depends on whether the LG First Use Wizard appears on the screen when you turn ON the TV:

(Continued on next page)

Ez Download Utility (Cont.)

(Continued from previous page)

- If the wizard is displayed, you can access the Ez Download utility via the EZ-Manager Wizard, as indicated above (see “Before You Begin”). However, to continue with this procedure and access the Ez Download utility from the TV menus, exit the First Use Wizard. Then, continue with step 3.
 - If the wizard is not displayed, go directly to step 3.
3. If the TV is currently in Pass-through Mode, you would like to transfer (import) a “.tlx” file to the TV via the Ez Download utility, and you intend to use one or both of the TV’s Zoning feature(s), set the appropriate TV Zone # and/or Wi-Fi Zone # in the TV at this time. See Reference section, “Using the TV’s Zoning Features,” for further information.



Note: In order for the proper TV Zone and/or Wi-Fi Zone profile data to be applied, the appropriate TV Zone # and/or Wi-Fi Zone # must be set in the Target TV BEFORE you continue with the Ez Download utility.

4. Insert the USB memory device with the appropriate file(s) into the TV’s USB port.
5. To access the TV Manager from the TV menus:
- Press **MENU** on the Installer Remote to display the TV setup menus (TV is in Pass-through Mode) or the Function Menu (TV is not in Pass-through Mode).
 - If the Quick Settings Menu is displayed at the right of the screen (i.e., the TV is in Pass-through Mode), select the **All Settings** ⓘ menu icon and press **OK** to access the advanced TV setup menus.
 - Use the arrow navigation keys to select/highlight either the **General** menu icon from the TV setup menus or the **Safety** menu icon from the Function Menu. Then, press the number “7” key a total of seven times.

Note: Ez Download is always selected by default when you initially access the TV Manager. Also note that Diagnostics is for service use only.

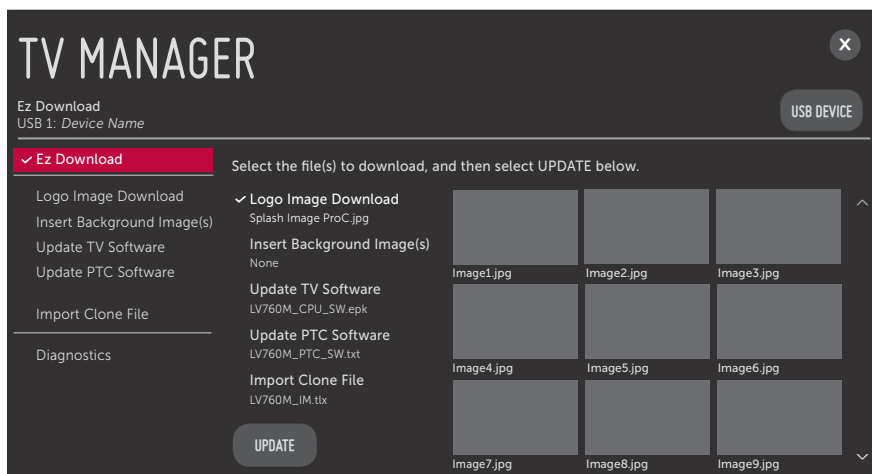

(Continued on next page)

(Continued from previous page)

6. If it is not currently selected, use the arrow keys to select **Ez Download**, and then press **OK**.

As illustrated in the example on the previous page, when Ez Download is selected, a list of files/file types is displayed on the screen. Remember that Logo (i.e., Splash Screen) Image, Background Image, TV Software (CPU), and PTC Software files must be stored in the LG_DTV folder and Clone/Configuration (.tlx) files must be stored in the root directory on the USB device.

Note: Select the  button in the top right corner of the screen, as necessary, to exit the TV Manager. If you accessed the TV Manager via the EZ-Manager Wizard, you will be returned to the last screen on display before you selected the "USB Configuration" option. If you accessed the TV Manager via the TV menus, you will be returned to program viewing.

7. To select a file:

- Use the arrow keys on the Installer Remote to select/highlight the appropriate file type field, and then press **OK**. A list of available files will be displayed to the right of the file type fields.
- Then, use the arrow keys to select the desired file.

Note: With the exception of background image files, the utility will only allow you to select one of each file type for downloading. For example, if there are two files in the Ez Download "Import Clone File" list, you can only select one or the other of those two files.

Note: The initial default value for each file type is "None." After the Ez Download utility is run, a file is automatically created and stored on the USB device that was used. The file, which will have a ".dzm" file extension, maintains a history of the file(s) previously used with the Ez Download utility. The next time(s) you use this USB device with the Ez Download utility, the file(s) selected for the last download will be pre-selected for the current download, thus facilitating the process of configuring additional TVs of this model using the same USB device.

Note: The current TV software (CPU) or PTC software version is always displayed above the listing of available TV software and PTC software files, respectively. Ensure the software version of the selected file is the correct version before applying the update to this TV.

8. If a Clone/Configuration (.tlx) file that includes an FTG Channel Map is selected, a Channel Tuning / Channel Banner Display field will be displayed at the right of the screen. If the FTG Channel Map comprises RF channels and Aux inputs *only* (the latter designated by 130-0 through 137-0), you can choose the format for the channel tuning/banner display. Use the arrow keys on the Installer Remote to select **Logical** tuning or **Physical** tuning. A checkmark will appear at the left of the selected option. Logical tuning is selected by default.

Note: If an FTG Channel Map includes IP channels, only logical tuning is available. Also, if the selected ".tlx" file does not include an FTG Channel Map, the message, "No Channel Map in Clone file," will be displayed at the right of the screen.

9. When you are ready to continue, use the arrow keys on the Installer Remote to select **UPDATE**, and then press **OK**.

(Continued on next page)

Ez Download Utility (Cont.)

(Continued from previous page)

Update progress will be displayed on the new screen. Do NOT remove the USB device while updates are in progress. When the Ez Download process is complete, an overview of the results will briefly be displayed and then, the TV will reboot.

10. Remove the USB memory device, and verify that the appropriate configuration/update(s) is/are resident on the TV.

Note: If you updated the TV configuration with a Clone/Configuration file, upon restart, the TV tunes according to the Start Channel setting in the Installer Menu. If a Start Channel is specified, the TV will tune to that channel, though in the case of FTG Mode via CPU configuration, a channel banner will only be displayed if the Start Channel is included in the FTG Channel Map (depending on your selection in step 8, the channel banner will display either the Start Channel's logical channel number or physical RF channel number). Otherwise, the TV will either return to the last channel tuned (TV in Pass-through Mode) or tune to the first channel in the FTG Channel Map (TV in FTG Mode via CPU). In the latter case, remember that the channels in the FTG Channel Map are always arranged in logical order, regardless of your selection in step 8.

Use the Installer Menu to set up, change, or view operational settings. This section describes how to access, use, and exit the Installer Menu from the TV itself. However, you should also refer to the Installer Menu descriptions in this document if you are configuring the TV CPU using an FTG Configuration (.tlx) file created using LG's Cloud Configuration Tool.

Refer to the table on pages 45 to 47 for brief descriptions of Installer Menu items. More detailed descriptions follow the table listing.

Accessing the Installer Menu

1. Turn ON the TV.

If the LG First Use Wizard appears on the screen when you turn ON the TV, exit the wizard.

2. Using an Installer Remote, press **MENU** repeatedly until the on-screen display of the TV setup menus (if the TV is in Pass-through Mode) or the Function Menu (if the TV is not in Pass-through Mode) no longer toggles, and then press the Installer Menu entry sequence (e.g., **9-8-7-6**) + **OK** to access the Installer Menu.

Note: The default Installer Menu entry sequence is "9876"; however, if Installer Menu item 000 INSTALLER SEQUENCE has been modified, the entry sequence may be one of three additional options. See Installer Menu detailed descriptions for further information.

The Installer Menu opens with item 000 INSTALLER SEQ 000.

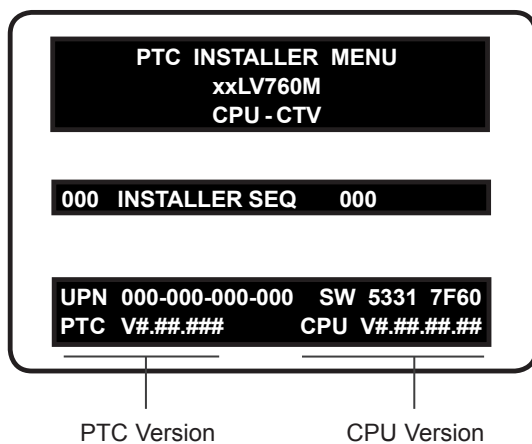

Typical Installer Menu

The Installer Menu header will vary depending on the TV you are setting up. In the Installer Menu footer, you can see the current software versions of the TV, as indicated.

Note: If the password (entry sequence) is not entered or registered correctly, you will see the message "ENTER PASSWORD 0000" at the top of the screen instead of the Installer Menu header. Once you re-enter the correct password (e.g., press 9-8-7-6 + OK), the Installer Menu will display.

Note: If the TV is not in Pass-through Mode, the Installer Menu is accessible as read-only. Also, the TV Zone # will be indicated in the Installer Menu header under the configuration mode indicator described below.

Installer Menu (Cont.)

As part of the Installer Menu header (in all modes), two 3-character acronyms are displayed to indicate the TV's current configuration mode. The table below lists all possible mode identifiers for these TV models.

Acronym	Description
CPU-CTV	Pass-through Mode with Channel Lineup in CPU
CPU-FTG	FTG Mode via CPU
CPU-P:C	Application Tuning Mode via CPU
MPI-EXT	External MPI Control
PTC-CTV	Pass-through Mode with Channel Map in PTC

Navigating Within the Installer Menu

Use the Up/Down arrow keys on the Installer Remote to sequence through the available menu items, or access an item directly by keying in the item number and then pressing **MENU**. For example, to access the SLEEP TIMER option, which is item 015, press 0-1-5 + MENU.

Installer Menu items not relevant to these TV models are not present in the Installer Menu; therefore, some numbers are missing. For example, item 006 will not appear. In addition, items that are dependent on other Installer Menu item settings will not be initially accessible. For example, item 046 STRT AUX SRCE will not display in the Installer Menu unless item 004 STRT CHANNEL is set to 0. See Installer Menu detailed descriptions for further information.

Modifying Installer Menu Settings

Refer to the table starting on the next page for an overview of the available Installer Menu items, including their item numbers, functions, value ranges, and default values.

To change an Installer Menu item value, use the Left/Right arrow keys on the Installer Remote to select the appropriate value, or direct enter a valid value. To save the new setting, press **OK** once on the Installer Remote. If you have additional items to modify, use the Up/Down arrow keys to navigate to a new Installer Menu item or access an item directly as described in the previous section. Note that invalid values will not be saved.



Caution: In order for Installer Menu item changes to be saved, you must press **OK** as indicated above and then exit the Installer Menu as described below. Never remove power from the TV while in the Installer Menu. Also, remember that Installer Menu settings may affect options available from the TV setup menus or the Function Menu.

Exiting the Installer Menu and Activating Settings

After you have saved all desired Installer Menu item changes (i.e., press **OK** once on the Installer Remote to save changes), press **OK** again to exit the Installer Menu. Any changes you make will be stored in non-volatile memory.

Note: Each time you exit the Installer Menu in Pass-through Mode, all V-Chip (Parental Control) settings in the TV are reset to their default values; that is, the Lock System, if previously enabled from the Safety Menu, will now be disabled, and the individual Parental Control settings will be restored to default values.

Installer Menu Items 000 through 046

Item	Function	Value Range	Default Value	Brief Description of Function
000	INSTALLER SEQ	0–3	0	Leave default set to 0.
001	POWER MANAGE	0–7	0	Selects the number of hours of inactivity allowed before the TV automatically turns itself OFF. Set to 0 to disable Power Management.
002	AC ON	0–3	0	Set to 1 to enable TV to turn ON when AC power is applied. Set to 2 or 3 to enable Instant ON when AC power is applied. See detailed descriptions.
003	BAND/AFC	0–3	1	Selects the RF Tuning Band: 0=Broadcast, 1=Cable, 2=HRC, 3=IRC
004	STRT CHANNEL	0–127, 253, 255	255	Channel tuned when the TV is turned ON. (Set to 255 to tune to channel tuned before the TV was turned OFF.)
005	CHAN LOCK	0 / 1	0	If set to 1, cannot tune from current channel.
007	STRT VOLUME	0–63, 255	255	Volume level when the TV is turned ON. (Set to 255 to use volume level set before the TV was turned OFF.)
008	MIN VOLUME	0–63	0	Sets the minimum allowable volume setting.
009	MAX VOLUME	0–63	63	Sets the maximum allowable volume setting.
010	MUTE DISABLE	0 / 1	0	Set to 1 to disable the Mute function.
011	KEY DEFEAT*	0 / 1	0	If set to 1, dome button menu navigation functions on the display panel are not available.
012	IR BANKS EN.	0 / 1	0	Set to 1 to enable the TV to respond to bank discrete IR codes.
013	SCAN MODE	0 / 1	1	Set to 1 to allow Channel Up/Down key presses to turn ON the TV. See detailed descriptions.
014	STRT CH IN SM	0 / 1	0	Set to 1 to use the Start Channel for the Channel Map pivot point in Scan Mode.
015	SLEEP TIMER	0 / 1	1	Set to 1 to enable the Sleep Timer feature.
016	EN. TIMER	0 / 1	1	Set to 1 to enable On/Off timers.
017	ALARM	0 / 1	1	Set to 1 to enable the Alarm feature in the Function Menu.
020	FEATURE LEVEL	0, 1, 16–24, 64, 65	1	Determines an additional IR code scheme to which the TV will respond.
021	V-CHIP	0 / 1	1	Set to 1 to enable V-Chip (Parental Control) functions.
022	MAX BLK HRS	0–99	12	Determines the maximum number of Parental Control blocking hours that can be set in the Function Menu.
023	CAPTION LOCK	0 / 1	0	Set to 1 to retain the caption setting selected before the TV was turned OFF.
025	FUNCTION PRE.	0 / 1	1	Set to 1 to allow Channel Preview/Banks Setup Menu access via the CH PREVIEW key on the Installer Remote.
027	HOSPITAL MODE	0–162, 254	254	Set according to the speaker selection, the pillow speaker code/supply voltage, and the hospital IR code. See detailed instructions.
028	CH. OVERRIDE	0 / 1	1	If set to 0, users can only tune to channels that are included in the PTC Channel Map. See detailed descriptions.
029	REMAP AUX INPS	0 / 1	0	Set to 1 to remap the PTC's direct tune channels for Aux inputs from 13x to 9x.
030	ACK MASK	0 / 1	0	If set to 1, enables the ACK feature of MPI.
031	POLL RATE	20–169	94	Selects the poll rate for MPI.
032	TIMING PULSE	186–227	207	Sets the baud rate for MPI.
035	HDMI1 ENABLE	0–2	1	Set to 0 to disable HDMI 1. Set to 1 (DTV Mode) or 2 (PC Mode), as applicable, to enable HDMI 1.
041	SIMPLINK EN	0 / 1	0	Determines the status of the SIMPLINK feature. See detailed descriptions.
042	AUTO INPUTS	0–255	0	Determines the Aux inputs for which auto-sensing is enabled. See detailed descriptions.
046	STRT AUX SRCE	3, 5, 255	255	Sets the starting Aux source (if item 004 STRT CHANNEL is set to 0).

* This item is applicable for 24/28LV760M models only.

Installer Menu (Cont.)

Installer Menu Items 047 through 116

Item	Function	Value Range	Default Value	Brief Description of Function
047	AUX STATUS	0 / 1	0	Controls the MPI status channel response for Aux sources. Set to 1 for the Aux source to be reported as its channel number.
049	DIS. AUDIO M.	0–9	0	Determines the availability of the Sound Out (Audio) Menu in the TV menus, as well as the default Audio Mode when the TV is turned ON. See detailed descriptions.
053	DIS. CH-TIME	0 / 1	0	Set to 1 to disable the TV's native Channel-Time display.
069	EN. CH-T COL.	0 / 1	1	Set to 1 to enable custom color for MPI display characters.
070	FOR. CH-TIME	0–7	2	Chooses custom foreground color for MPI display characters.
071	BCK. CH-TIME	0–7	2	Chooses custom background color for MPI display characters.
073	CH NOT AVBLE	0 / 1	0	If set to 1 and item 028 CH. OVERRIDE is set to 0, a "CHANNEL NOT AVAILABLE" message is displayed if the user attempts to direct tune a channel that is not included in the channel lineup.
075	REVERT CH	0 / 1	0	If set to 1 and loss of MPI communication occurs, the TV tunes to Start Channel.
077	QUICK SHUTOFF	0–17	0	Allows the TV to be turned OFF with press and hold of pillow speaker channel buttons. Set to 0 to disable. Set from 1 to 17 to define the hold time. See detailed descriptions.
078	UPN MSB	0–255	255	User programmable number, most significant byte.
079	UPN MSB-1	0–255	255	User programmable number, most significant byte - 1.
080	UPN MSB-2	0–255	255	User programmable number, most significant byte - 2.
081	UPN LSB	0–255	255	User programmable number, least significant byte.
082	CHKSM ERROR	0 / 1	1	Enforces rigid MPI checksum.
083	HANDSHK TIME	0–5	5	Relaxes MPI timing to be compatible with PC-based Windows-controlled systems.
084	PERMANENT BLK	0 / 1	0	Set to 1 to remove the blocking hours setting in the Function Menu for Parental Control and make the block permanent.
086	V. MUTE TIME	0–50	0	Use to extend the normal video mute time during channel change.
088	EN NOISE MUTE	0 / 1	1	(Analog channels only) If set to 1, audio is muted if no signal is present.
090	KEY LOCK	0 / 1	0	If set to 1, the display panel power button function is locked. IR is still functional.
091	HDMI2 ENABLE	0–2	1	Set to 0 to disable HDMI 2. Set to 1 (DTV Mode) or 2 (PC Mode), as applicable, to enable HDMI 2.
094	SAP MENU EN	0 / 1	1	Set to 1 to enable the SAP feature in the Function Menu.
096	DEF. ASP. RATIO*	0–4	2	Selects the default aspect ratio. See detailed descriptions.
098	PRO:CENTRIC	0–3	0	Set to 0 to disable Pro:Centric operation. Set to 1 for Flash Mode. Set to 2 for GEM (Java Application) Mode. Set to 3 for HTML Mode.
099	BACK LIGHTING	1–202, 255	255	Sets the level of the TV picture back lighting. See detailed descriptions.
101	IR FEEDBACK**	0 / 2	0	Set to 2 to disable the TV's MMR feature.
102	ATSC BAND	0–4	4	Selects the RF band used by the ATSC tuner. See detailed descriptions.
103	ATSC TUNE MODE	0 / 1	1	Set to 1 for Physical Channel tuning. Set to 0 for Virtual Channel tuning.
104	START MINOR CH	0–255	0	Selects the Minor Start Channel number. Set to 0 for analog (NTSC) channel.
106	ASP RATIO LOCK	0 / 1	0	Set to 0 to use the default aspect ratio each time the TV is turned ON. Set to 1 to retain the aspect ratio set before the TV was turned OFF.
107	BANNER SELECT	0 / 1	1	Selects the type of banner to display during channel change.
116	VIDEO MUTE EN	0 / 1	0	(Analog channels only) If set to 1, video mutes (blank screen) when no signal is present.

* Value 4 is applicable for 32LV760M models only.

** This item is applicable for 32LV760M models only.

Installer Menu Items 117 through 122

Item	Function	Value Range	Default Value	Brief Description of Function
117	FACT DEFAULT	0 / 1	0	Set to 1 to restore the factory default settings of all Installer Menu items.
119	DATA CHANNEL	0–135, 253, 255	255	Set to 0 to disable. Set from 1 to 135 to match the RF channel number used by the Pro:Centric server as its data channel. Set to 255 to use Auto Search to find the Pro:Centric RF channel. See detailed descriptions.
121	UPDATE TIME HR	0–23, 128, 255	128	Sets the Wake For Update hour. See detailed descriptions.
122	UPDATE TIME MN	0–59, 255	0	Sets the minute for Wake For Update. See detailed descriptions.

Detailed Descriptions of Installer Menu Items

000 - INSTALLER SEQUENCE

Specifies entry sequence to the Installer Menu.

0 = 9876 1 = 4321
2 = 1478 3 = 3698

001 - POWER MANAGE (Power Management)

Energy saving feature. Determines the number of hours, in the range 1 to 7, of inactivity allowed, either at the TV control panel or from the remote, before the TV automatically turns itself OFF. If set to 0, Power Management is disabled.

002 - AC ON (AC Power Switchable)

If set to 1, this allows the TV to turn ON when AC power is applied. Pressing the POWER button is not necessary. This is desirable if the TV is plugged into a switched AC outlet (i.e., a set-top box). Set to 2 or 3 to enable the Instant ON feature (see additional information below). Set to 0 (default) for standard TV turn ON/OFF operation.

The Instant ON feature allows the TV to turn ON when AC power is applied, but with video and audio muted (Muted ON). The TV retains its ON status while appearing to be OFF. Pressing the POWER button toggles off/on the video and audio mutes, so that the TV appears to turn ON instantly.

- If this item is set to 2, the TV will reboot and, if applicable (i.e., item 119 DATA CHANNEL set from 1 to 135 or 253), check for and download any available updates from the Pro:Centric server at every turn OFF. This setting is not recommended if the TV will be configured with a resident application.
- If this item is set to 3, the TV will not reboot to check for and download updates at turn OFF, with the following exception: the first time the TV is turned OFF after this item is set to 3, the TV will reboot and initiate an update event (Data Channel Auto Search and/or check for and download of updates—see also paragraph below). This setting is recommended if the TV will be configured with a resident application. In this mode, the standard check for and download of updates is under application control. Refer to your site-specific documentation for further information on configuring the TV with a resident application.

When this item is set to 2 or 3, the TV also will reboot and initiate an update event once every 24 hours. During the update event, the TV, as applicable, performs a Data Channel Auto Search (item 119 set to 255) and/or checks for and downloads any available updates from the Pro:Centric server (item 119 set from 1 to 135 or 253). The time at which this event occurs depends on the setting of item 121 UPDATE TIME HR. See item 119 and 121 descriptions for further information. Once the update cycle is complete, the TV completes the reboot and resumes its Muted ON state.

Note: If set to 1, the TV does not respond to ON/OFF commands from either the remote or the display panel, and the Sleep Timer is also nonfunctional.

Note: Instant ON is not supported when the TV is in MPI-EXT Mode.

003 - BAND/AFC (Tuning Band)

Selects the RF band used by the NTSC tuner:

0 = Broadcast 1 = Cable (default)
2 = HRC 3 = IRC

Determine the RF band used by the RF distribution system, and then select the appropriate value for this item before tuning channels or running Auto Tuning (Channel Search). See also item 102 ATSC BAND.

004 - STRT CHANNEL (Start Channel)

If active, this function allows you to determine the initial Major Start Channel number when the TV is turned ON. This feature is useful for an in-house information channel, since the TV would always select that channel when it is turned ON. If set to 255, the last channel tuned before the TV was turned OFF will be the channel tuned when the TV is turned ON again.

0 = Aux 127 = Map to Major CH 4
1–125 = Major Ch. # 253 = IP Start Channel
126 = Map to Major CH 3 255 = Last Channel

For a digital (ATSC) Start Channel, always remember to set item 104 to the Minor Start Channel number. If setting this item to 0 (Aux), make sure to also set item 046 STRT AUX SRCE to the appropriate value.

Installer Menu (Cont.)

Note: 126 and 127 are mapped only in SONIFI PPV Mode.

Note: The IP Start Channel shown above can only be set in the Cloud Configuration Tool, which is typically used to configure TV CPUs for FTG Mode. The same applies for the additional Major Channel number range of 128–135 in Physical tuning and 128–999 in Virtual tuning mode. When the TV is in FTG Mode, the appropriate values will be visible in the (read-only) Installer Menu. For an IP Start Channel, item 004 will show value 253, the IP address, and the port number. For an RF Start Channel, item 004 will show the channel's Major and Minor numbers.

Note: If the TV is being configured for Application Tuning Mode operation with Pro:Centric Direct, the Start Channel is set in the Pro:Centric Direct Admin Client, and Installer Menu item 004 is automatically updated accordingly. When the TV is in Application Tuning Mode, the appropriate values will be visible in the (read-only) Installer Menu. For an IP Start Channel, item 004 will show value 253, the IP address, and the port number. For an RF Start Channel, item 004 will show the channel's Major and Minor numbers.

005 - CHAN LOCK (Channel Lock)

Channel Lock is ideal if the system must always be on the same channel. If set to 1, Channel Lock is enabled and it is not possible to change channels with Channel Up/Down or number keys. If set to 0 (default), Channel Lock is disabled.

Generally, this feature is used in connection with item 004 STRT CHANNEL where the Start Channel may, for example, be set to 3 or 4. If the Start Channel is 3, then the TV will remain locked on channel 3.

NOTE: For items 007, 008, and 009

For legacy reasons, the scale used is 0–63. The PTC software will translate this to the 0–100 scale used by the TV.

To translate a TV volume level to the Installer Menu value, use the following formula:

$$\text{Installer Value} = \frac{\text{TV Value} \times 63}{100}$$

Enter only the whole number (disregard fractions).

007 - STRT VOLUME (Start Volume)

This function allows the Installer to determine the initial volume level setting when the TV is turned ON. This feature is useful for an in-house information channel, since the TV will always select that volume level when it is turned ON. The range of values is 0 to 63, 255. If set to 255, the last volume level before the TV was turned OFF will be the current volume level when the TV is turned ON again.

008 - MIN VOLUME (Minimum Volume)

This function determines the minimum volume level allowable with the Volume (VOL) Up/Down control. In this way, for example, someone cannot set the volume too low to hear. The value range is from 0 to 63. The factory default is 0, which provides the full

range of volume control, if item 009 MAX VOLUME is set to 63. It is recommended to set the same value on every TV.

Note: The minimum volume level cannot have a value setting higher than the maximum volume level (described below).

009 - MAX VOLUME (Maximum Volume)

This function determines the maximum volume level allowable with the Volume (VOL) Up/Down control. In this way, for example, someone cannot set the volume level high enough to disturb others. The value range is 0 to 63, with 63 as the default, which gives the user the full range of volume control, if item 008 MIN VOLUME is set to 0. It is recommended to set the same value on every TV.

Note: The maximum volume level cannot have a value setting lower than the minimum volume level (described above).

010 - MUTE DISABLE

Enables or disables the sound Mute function. If set to 1, sound cannot be muted. If set to 0, sound can be muted.

011 - KEY DEFEAT

If set to 1, Key Defeat is enabled, which means that end users cannot access or navigate within the on-screen menu(s) from the display panel; i.e., dome button menu navigation functions will not be available. Set to 0 to disable Key Defeat. Note that all IR features remain functional regardless of this setting; users can always access the menus by pressing MENU on the remote.

Note: The dome button is only available on 24/28LV760M models. On 32LV760M models, a power button at the bottom of the display turns the TV ON or OFF.

012 - IR BANKS EN. (IR Banks Enable)

When enabled, you can direct access a particular channel bank by inputting the discrete IR code for that bank.

Note: This item is not available in the Installer Menu when item 027 HOSPITAL MODE is set to 0.

013 - SCAN MODE

If set to 1 (default), the TV can be turned ON with Channel Up/Down key presses. Also, the TV will turn OFF when Channel Up/Down is used to tune above or below the Channel Map pivot point. By default, the Channel Map pivot point is between the highest and lowest channel in the Channel Map (also see item 014 STRT CH IN SM). Set to 0 to disable.

Note: This item is only applicable when the TV is in PTC-CTV Mode or FTG Mode via CPU.

014 - STRT CH IN SM (Start Channel in Scan Mode)

Only valid when item 013 SCAN MODE is set to 1 (enabled). Set to 1 to force the Channel Map pivot point to be between the RF channel designated as the Start Channel (see item 004 STRT CHANNEL) and next lower channel in the Channel Map. Set to 0 (default) to disable.

Note: This item is not available in the Installer Menu when item 013 SCAN MODE is set to 0.

015 - SLEEP TIMER

If set to 1, the Sleep Timer feature is enabled and available to the end user. Set to 0 to disable the Sleep Timer feature.

016 - EN TIMER (Enable On/Off Timers)

If set to 1, the Timer function is enabled and available to the end user. Set to 0 to disable On/Off timers.

Note: The TV clock must be set in order for timers to be used.

017 - ALARM

If set to 1, the Alarm feature is enabled and available to the end user in the Function Menu (i.e., the TV is not in Pass-through Mode). Set to 0 to disable the Alarm feature.

Note: The TV clock must be set before the Alarm feature will work.

020 - FEATURE LEVEL

Determines an additional IR code scheme to which the TV will respond, allowing for the use of unique IR codes based on “bed number” in a multi-TV single room installation. First determine the IR mode; then select the bed number.

Note: When item 027 HOSPITAL MODE is set to 0, both the IR code that will control the TV and the speaker selection are determined by this item (default = 1). Set this item as required to enable Zenith Bed 1 or Bed 2 IR codes and speaker selections.

Values	IR Mode	Bed #	Speaker
0 – 1	Zenith (Hospital)	1 – 2	TV Only
16 – 24	Multi-code Remote	1 – 9	TV Only
64 – 65	Zenith (Hospital)	1 – 2	Pillow Only

Note: See Reference section, “LG Pro:Centric Patient Remote and Pillow Speaker,” for additional information. Also, see documentation for the accessory package that includes the multi-code remote.

021 - V-CHIP (Parental Control)

Set to 1 to activate V-Chip (Parental Control) and have it available to the end user to filter and control or otherwise restrict programming content that can appear. Set to 0 to turn off the V-Chip feature (not available to user); no programming restrictions can be set.

022 - MAX BLK HRS (Maximum Block Hours)

Sets hours from 0 to 99 for the maximum number of Parental Control blocking hours that can be set in the Function Menu (i.e., the TV is not in Pass-through Mode). Default setting is for 12 blocking hours.

Note: This item is not available in the Installer Menu when item 021 V-CHIP is set to 0 or when item 084 PERMANENT BLK is set to 1.

023 - CAPTION LOCK

If set to 0, captions are OFF when the TV is turned ON. If set to 1, the caption setting selected before the TV was turned OFF will be the current caption setting when the TV is turned ON again.

025 - FUNCTION PRE (Function Preview)

Set to 1 to allow access to the Channel Preview/Banks Setup Menu via the CH PREVIEW key on the Installer Remote. Set to 0 to disable access to the Channel Preview/Banks Setup Menu.

Note: This item is only applicable when the TV is in PTC-CTV Mode.

027 - HOSPITAL MODE

Set according to the speaker selection, the pillow speaker code/ supply voltage and the hospital IR code. If using a Pro:Centric pillow speaker, select one of the Zenith codes in accordance with the desired speaker selection. See table below.

When Hospital Mode is enabled, channel banks are also available. Refer to “Channel Banks Overview” on pages 36 to 38 for further information. Channel banks are not supported if Hospital Mode is set to 0.

Value	Speaker	Pillow Speaker Code/Voltage	Hospital IR Code
000	Determined by item 020 setting	Zenith (+12v)	Determined by item 020 setting
001	Pillow Only	Zenith (+12v)	Zenith Bed #1
002	Pillow Only	Zenith (+12v)	Zenith Bed #2
017	Pillow Only	Philips (+5v)	Zenith Bed #1
018	Pillow Only	Philips (+5v)	Zenith Bed #2
033	Pillow Only	RCA (-5v)	Zenith Bed #1
034	Pillow Only	RCA (-5v)	Zenith Bed #2
065	TV Only	Zenith (+12v)	Zenith Bed #1
066	TV Only	Zenith (+12v)	Zenith Bed #2
081	TV Only	Philips (+5v)	Zenith Bed #1
082	TV Only	Philips (+5v)	Zenith Bed #2
097	TV Only	RCA (-5v)	Zenith Bed #1
098	TV Only	RCA (-5v)	Zenith Bed #2
129	Both Pillow & TV	Zenith (+12v)	Zenith Bed #1
130	Both Pillow & TV	Zenith (+12v)	Zenith Bed #2
145	Both Pillow & TV	Philips (+5v)	Zenith Bed #1
146	Both Pillow & TV	Philips (+5v)	Zenith Bed #2
161	Both Pillow & TV	RCA (-5v)	Zenith Bed #1
162	Both Pillow & TV	RCA (-5v)	Zenith Bed #2
254	TV Only	Disabled (0v)	Zenith Bed #2

When Hospital Mode is set to 0 (disabled), both the IR code that will control the TV and the speaker selection depend on the Installer Menu item 020 FEATURE LEVEL setting.

Note: The default setting (254) is not selectable in the Installer Menu. If you ever need to restore the default setting, you must reload the factory default settings. See item 117 description and/or Reference section, “Restoring Factory Defaults on the TV(s),” for further information.

Installer Menu (Cont.)

Note: In the Installer Menu, an informational code is displayed at the right of each Hospital Mode value. Each code consists of three characters. The first character—T, P, or B—identifies the speaker: TV, Pillow, or Both. The second character—Z, P, R, or D—identifies the pillow speaker code: Zenith, Philips, RCA, or Disabled. The third character—1 or 2—identifies the bed number. In the table above, each bolded character represents an element of the Hospital Mode code.

028 - CH. OVERRIDE (Channel Override)

This item either allows or restricts tuning of channels that are NOT in the PTC Channel Map. If set to 1, end users can tune channels that are not in the PTC Channel Map by direct keypad entry. If set to 0, users are restricted to only the channels that are in the PTC Channel Map. In the case of CPU-CTV Mode, there are no channels in the PTC Channel Map; therefore, direct keypad entry is not available. Also, when this item is set to 0, the PTC Channel Map (PTC-CTV Mode)/CPU channel lineup (CPU-CTV Mode) is locked, and user access to channel settings in the TV setup menus is restricted.

Note: This item is not applicable when the TV is in FTG Mode or Application Tuning Mode.

029 - REMAP AUX INPS

Set to 1 to remap the PTC's direct tune channels for Aux inputs from 13x to 9x. This allows 2-digit only tuning systems (i.e., legacy On Command Video™) to direct tune Aux inputs. See also Reference section, "TV Aux Input Configuration."

030 - ACK MASK

MPI Communication Parameter. When set to 1, enables the ACK feature of MPI.

031 - POLL RATE

MPI Communication Parameter. Selects the poll rate for MPI. Step size of 16 ms. Changing from default may affect communication via MPI.

032 - TIMING PULSE

MPI Communication Parameter. Sets the baud rate for MPI. Step size of 4.3 uS. Changing from default may affect communication via MPI.

035 - HDMI1 ENABLE

Set to 1 to enable HDMI 1 input in DTV Mode. Set to 2 to enable HDMI 1 input in PC Mode. Set to 0 to disable display panel HDMI 1 input.

041 - SIMPLINK EN

Set to 0 to disable the SIMPLINK feature. Set to 1 to enable SIMPLINK functionality (does not enable remote control access to the SIMPLINK Menu).

Note: When both this item *and* item 042 AUTO INPUTS are enabled in the Installer Menu, HDMI inputs will be detected by SIMPLINK, but the Auto Input(s) Sensing Feature will not function.

042 - AUTO INPUTS

Determines the Aux inputs for which auto-sensing is enabled. Set to 0 to disable auto-sensing for all available inputs. Set to 255 to enable auto-sensing for all available inputs. For information on options for individual input settings, see Reference section, "Auto Input(s) Sensing Feature."

Note: In order for auto-sensing to be enabled for an input, that input must also be enabled in the Installer Menu. For example, to enable auto-sensing for HDMI 1, item 035 HDMI1 ENABLE must also be set to 1 or 2. Also, see note above regarding TV operation when both this item and item 041 SIMPLINK EN are enabled.

046 - STRT AUX SRCE (Start Aux Source)

Sets the starting Aux source. When turned ON, the TV will tune to the starting Aux source if item 004 STRT CHANNEL is set to 0.

3 = HDMI 1 5 = HDMI 2 255 = Last Aux

Note: In order for an Aux input to be selected as the starting Aux source, the input also must be enabled in the Installer Menu.

Note: This item is not available in the Installer Menu unless item 004 STRT CHANNEL is set to 0.

047 - AUX STATUS

Controls the MPI status channel response for Aux sources. Set to 1 for the Aux source to be reported as its channel number. Set to 0 for the Aux source to be reported as channel 0. See Reference section, "TV Aux Input Configuration," for Direct Access channel numbers.

049 - DIS. AUDIO M. (Disable Audio Menu)

Determines the availability of the Sound Out (Audio) Menu in the TV menus. Also determines the default Audio Mode when TV is turned ON. See the table below and set as required. See also notes below.

Value	Sound Out Menu Status	Default Audio Mode at TV Turn ON
0 (default)	Enabled	TV Speaker
1	Disabled	TV Speaker
2	Enabled	External Speaker (Optical/HDMI ARC)
3	Disabled	External Speaker (Optical/HDMI ARC)
4	Enabled	LG Sound Sync (Optical)
5	Disabled	LG Sound Sync (Optical)
6	Enabled	LG Sound Sync (Wireless/BT)
7	Disabled	LG Sound Sync (Wireless/BT)
8	Enabled	TV Speaker + Audio Out (Optical)
9	Disabled	TV Speaker + Audio Out (Optical)

Note: If a SIMPLINK-enabled device is connected to the TV and item 041 SIMPLINK EN is set to 1 (enabled), the SIMPLINK device Audio Mode will have priority over the setting of this item when the TV is turned ON.

Note: Items 020 FEATURE LEVEL and 027 HOSPITAL MODE have priority over the setting of this item. Thus, if either item 020 or 027 is set to a Pillow Only value and this item is set to an internal TV speaker value, the pillow speaker setting will have priority, and you will not be able to hear sound from the TV speaker. You may however, set an external speaker configuration in conjunction with the pillow speaker.

053 - DIS. CH-TIME (Disable Channel-Time Display)

Set to 1 to disable the TV's native Channel-Time display when a custom channel label/channel information will be provided by the MPI command. Set to 0 to enable the TV's native Channel-Time display.

069 - EN. CH-T COL. (Enable Display Characters Custom Color)

Set to 1 to enable custom color for MPI display characters. Set to 0 to disable custom color for MPI display characters.

070 - FOR. CH-TIME (Display Characters Foreground Color)

Set the foreground color for MPI display characters according to the following color chart:

0 = Black	2 = Green	4 = Red	6 = Yellow
1 = Blue	3 = Cyan	5 = Violet	7 = White

If the foreground and background colors for the display characters are the same, the background will be transparent.

Note: This item and item 071 BCK. CH-TIME also apply to the "Channel Not Available" message if item 073 CH NOT AVBLE is set to 1 (enabled).

Note: Items 070 FOR. CH-TIME and 071 BCK. CH-TIME are only available in the Installer Menu when item 069 EN. CH-T COL. is set to 1.

071 - BCK. CH-TIME (Display Characters Background Color)

See description for item 070 FOR. CH-TIME above. The color chart is the same for both items.

073 - CH NOT AVBLE (Channel Not Available)

If set to 1 and item 028 CH. OVERRIDE is set to 0, a "CHANNEL NOT AVAILABLE" message is displayed when a user attempts to direct tune a channel that is not included in the channel lineup.

Note: This item is not available in the Installer Menu when item 028 CH. OVERRIDE is set to 1.

Note: This item is only applicable when the TV is in PTC-CTV Mode.

075 - REVERT CH (Revert to Start Channel)

If set to 1 and loss of MPI communication occurs, the TV automatically tunes to the specified Start Channel.

Note: This item is not available in the Installer Menu when item 004 STRT CHANNEL is set to 255.

077 - QUICK SHUTOFF

Allows the end user to turn OFF the TV using the mechanical (analog) pillow speaker Channel Up/Down keys. The user needs to press and hold either channel key for the time determined by the value set. Set to 0 to disable. Set from 1 to 17 to establish the required hold time of the key—from 2 seconds to 10 seconds in half-second increments.

Note: This item is not available in the Installer Menu when item 013 SCAN MODE is set to 0.

078 - UPN MSB (UPN Most Significant Byte)

User programmable number, most significant byte readable by MPI command. Note: Not linked to serial number.

079 - UPN MSB-1 (UPN Most Significant Byte-1)

User programmable number, most significant byte-1 readable by MPI command. Note: Not linked to serial number.

080 - UPN MSB-2 (UPN Most Significant Byte-2)

User programmable number, most significant byte-2 readable by MPI command. Note: Not linked to serial number.

081 - UPN LSB (UPN Least Significant Byte)

User programmable number, least significant byte readable by MPI command. Note: Not linked to serial number.

082 - CHKSM ERROR (Checksum Error)

Enforces rigid MPI checksum validation. Set to 1 for validation. Set to 0 to disable (does not check checksum on MPI async port). SPI is always checked.

083 - HANDSHK TIME (Handshake Time)

Adds an additional delay to the handshake time which is 64 msec, thus relaxing MPI timing requirements to be compatible with PC-based Windows controlled systems. Range is 0 - 5. (Timeout = 25.5MS + [25.5 MS* Handshake time].)

084 - PERMANENT BLK (Permanent Block)

Allows Parental Control blocking schemes to be permanent by disabling the user's ability to limit blocking hours in the Function Menu. Set to 1 to install Parental Control restrictions permanently. Set to 0 for user-specified hours control of blocking schemes. See also item 022 MAX BLK HRS.

Note: This item is not available in the Installer Menu when item 021 V-CHIP is set to 0.

086 - V. MUTE TIME (Video Mute Time)

Use to extend the normal video mute time during channel change. For example, you may wish to extend the normal video mute time to prevent the display of encrypted video (i.e., from a Pro:Idiom encrypted channel) that has not yet been decrypted. When set to 0, the normal video mute time is not extended. Set from 1 to 50 to increase the normal video mute time in 100 ms step increments up to a maximum of 5 seconds (e.g., the value of 25 represents 2.5 seconds, or 25 x 100 ms = 2.5 seconds).

Installer Menu (Cont.)

088 - EN NOISE MUTE (Enable Noise Mute)

Applicable for analog channels only. If set to 1, audio mutes if no signal is present.

090 - KEY LOCK

If set to 1, Key Lock is enabled, which means that the display panel power button function will be locked, i.e., non-functional. Set to 0 to disable Key Lock. Note that all IR features remain functional regardless of this setting.

091 - HDMI2 ENABLE

Set to 1 to enable HDMI 2 input in DTV Mode. Set to 2 to enable HDMI 2 input in PC Mode. Set to 0 to disable display panel HDMI 2 input.

094 - SAP MENU EN (2nd Audio Program)

Set to 1 to enable the SAP feature in the Function Menu (i.e., the TV is not in Pass-through Mode). Set to 0 to disable the SAP feature in the Function Menu.

096 - DEF. ASP. RATIO (Default Aspect Ratio)

Selects the aspect ratio to be set as default each time the TV is turned ON:

0 = Set By Program	1 = 4:3
2 = 16:9 (default)	3 = Just Scan
4 = Zoom	

Note: See also item 106 ASP RATIO LOCK. This item (i.e., item 096) is not available in the Installer Menu when item 106 is set to 1.

Note: Value 4 is applicable for 32LV760M models only.

098 - PRO:CENTRIC

Selects the Pro:Centric Application Mode. Set to 0 (default) to disable the Pro:Centric application. Set to 1 for Flash Mode. Set to 2 for GEM (Java Application) Mode. Set to 3 for HTML Mode.

In order to retrieve the Pro:Centric application when enabled (for Flash, GEM, or HTML Mode), the TV must be turned OFF/ON two times. Once you exit the Installer Menu, turn OFF the TV for at least one minute. When you turn the TV back ON, the TV will start the appropriate library based on the setting of this item. Wait until TV programming appears on the display, and then turn the TV back OFF, this time for a few minutes, to initiate the application download. When you turn the TV back ON, press PORTAL on the Installer Remote, and verify that the Pro:Centric application appears on the display.

Note: This item is not available in the Installer Menu when item 119 DATA CHANNEL is set to 0.

099 - BACK LIGHTING

Sets the TV screen brightness. Default setting is 255.

- 1 (dimpest picture)– 100 (brightest picture) Static Back Lighting
- 101 (dimpest picture)– 200 (brightest picture) Dynamic Back Lighting: The TV automatically controls back lighting depending upon the picture level of the current program.

- 201 Automatic Static Back Lighting: The TV automatically controls back lighting by using Intelligent Sensor to detect the level of ambient lighting.
- 202 Automatic Dynamic Back Lighting: The TV automatically controls back lighting by using Intelligent Sensor to detect the level of ambient lighting and depending upon the picture level of the current program.

If set to 201 or 202, back lighting can be controlled via the Picture settings in the TV setup menus. However, each time the TV is turned ON, Picture Mode (set in Picture Menu) is defaulted to Intelligent Sensor. If Picture Mode is manually set to a static option (Vivid, Standard, etc.) during a viewing session, Intelligent Sensor is temporarily disabled.

If set to 255, back lighting is controlled via the Picture settings in the TV's setup menus.

101 - IR FEEDBACK

If set to 0 (default), the TV's MMR (Magic Motion Remote) feature is enabled, and a compatible LG MMR (not supplied) may be used with the TV. If set to 2, the MMR feature is disabled.

Note: This item is applicable for 32LV760M models only.

102 - ATSC BAND

Selects the RF band used by the ATSC tuner:

0 = Broadcast	1 = Cable	2 = HRC
3 = IRC	4 = Same as NTSC (default)	

103 - ATSC TUNE MODE

Sets the ATSC tuning mode. Default set to 1 for Physical Channel tuning. Set to 0 for Virtual Channel tuning.

104 - START MINOR CHANNEL

When a digital (ATSC) Start Channel has been specified for item 004 STRT CHANNEL, this item sets the Minor Start Channel number. Set to 0 when an analog (NTSC) Start Channel has been specified for item 004.

Note: This item is not available in the Installer Menu when item 004 STRT CHANNEL is set to 0 or 255.

106 - ASP RATIO LOCK (Aspect Ratio Lock)

Set to 0 to use the default aspect ratio each time the TV is turned ON (see item 096 DEF. ASP. RATIO). If set to 1, the aspect ratio set before the TV was turned OFF will be the current aspect ratio when the TV is turned ON again.

107 - BANNER SELECT

Selects the type of banner to display during channel change. Set to 1 for channel label display, plus channel information (full banner). Set to 0 for channel label display only (small banner).

116 - VIDEO MUTE EN (Video Mute Enable)

Applicable for analog channels only. If set to 1, video mutes (blank screen) when no signal is present.

117 - FACT DEFAULT (Factory Default)

Set to 1 and press OK to restore the factory default settings of all Installer Menu items. Once complete, the value returns to 0.



Caution: If set to 1, this clears all Installer Menu custom settings and restores the factory default settings. It also clears the channel lineup, including any assigned channel icons and custom text labels.

Note: See also Reference section, "Restoring Factory Defaults on the TV(s)," for further information.

119 - DATA CHANNEL

Set to 0 to disable. Set from 1 to 135 to match the RF channel number that will be used by the Pro:Centric server as its data channel. If left at the default value (255), the TV's Data Channel Auto Search feature will be enabled (see additional information below).*

Data Channel Auto Search feature: When this item is set to 255 (default), once every 24 hours, the TV will initiate a search of 10 predefined channels (10, 20, 30, ... 100) and then, if necessary, perform a complete search of the RF channels (1 to 135) in an attempt to find the RF channel used by the Pro:Centric server as its data channel. If the Pro:Centric RF channel is found, the DATA CHANNEL value will be changed from 255 to match the server's RF channel number. The time at which the Auto Search occurs depends on the setting of item 121 UPDATE TIME HR. See item 121 description for further information.

Note: Pro:Centric updates are downloaded from the Pro:Centric server to the TV when the TV is turned OFF. While Pro:Centric updates are in progress, it is not possible to turn ON the TV.

Note: The Data Channel is automatically set to "253" if Media Type is set to "IP" in the EZ-Manager Wizard or Express Script or in the IP Environment / Pro:Centric Menu on the TV (see "LG First Use Wizard" on pages 17 to 18 or "Pro:Centric Setup" on pages 74 to 76, respectively) or if Installer Menu item #119 Data Channel is set to "IP Address" or "IP Domain Name" in the Cloud Configuration Tool, which is typically used to configure TV CPUs for FTG Mode operation. It is not possible to change the value to "253" directly in the Installer Menu.

121 - UPDATE TIME HR

Based on the settings of this item and item 122 UPDATE TIME MN, the Wake For Update feature wakes the TV once daily to check for and, if applicable, download updates from the Pro:Centric server.

Set the Wake For Update hour from 0 to 23. This item uses the 24-hour clock format. The value "128" (default) is displayed as "OFF." Directly entering 128 resets the default value (OFF) for this item, though note that this setting does not mean the TV will not initiate update events—see additional information below.

Under standard TV OFF/ON operating conditions (i.e., item 002 AC ON is set to 0), a Wake For Update event occurs when the TV is OFF and causes the TV's CPU to temporarily turn ON, perform the update cycle, and then turn back OFF, all while the TV appears to be OFF. If item 002 AC ON is set to 2 or 3 for Instant ON, then the TV's CPU is always ON and Wake For Update occurs when the TV is in its Muted ON state (i.e., the TV only appears to be OFF). The Wake For Update event causes the TV's CPU to reboot in order to perform the update cycle and then return to its Muted ON state. See also description for item 002.

Random Distribution of Update Time: If this item is set to 128 (OFF), the time at which a Data Channel Auto Search (item 119 set to 255) and/or an Instant ON update (item 002 set to 2 or 3) occurs is determined as follows: Each TV initiates the search and/or checks for updates during the 2 AM hour (if the TV clock is set) or after two hours of elapsed time from when AC power was applied (if the TV clock is not set). Also, in this case, a fixed update time minute from 0 to 59 that has been assigned to each TV is used. (The intention of this feature is to prevent all of the installed TVs from performing updates at the same time; however, note that in installations that have a large quantity of TVs with this feature, there will be some TVs that have the same update minute assignments.) The update time for the TV is displayed at the right of this item in the Installer Menu, for example:

121 UPDATE TIME HR OFF 02:34

If the TV display is ON when a Wake For Update event is to occur, the update will take place the next time the TV is turned OFF.



Caution: UPDATE TIME HR should NEVER be set to 255. This setting is intended for factory use only.

Note: This item is not available in the Installer Menu when item 119 DATA CHANNEL is set to 0, except when item 002 AC ON is set to 2 or 3 for Instant ON.

Note: The TV clock must be set in order for a Wake For Update event to occur at the precise time of day in accordance with item 121 and item 122 settings.

122 - UPDATE TIME MN

Set the Wake For Update minute from 0 to 59. If item 121 is NOT set to 128 and you wish to invoke the "random" minute assignment on the TV, set this item to 255. See also description for item 121 UPDATE TIME HR above.

Note: This item is not available in the Installer Menu unless item 121 UPDATE TIME HR is set from 0 to 23.

Note: The TV clock must be set in order for a Wake For Update event to occur at the precise time of day in accordance with item 121 and item 122 settings.

* PCS150R and later Pro:Centric servers do not support HRC or IRC cable channel frequencies.

Custom Master TV Setup

This section describes how to create a customized Master TV Setup for cloning purposes when the TV is in Pass-through Mode. All cloning (export and import) processes on the TV are performed via USB memory device / “.tlx” file. The Master TV Setup may be exported to a Clone (.tlx) file, which can then be used (i.e., imported) to configure either TVs that are to remain in Pass-through Mode or TVs that are to be configured for FTG Mode via CPU.

Cloning requirements and procedures are described in detail on pages 57 to 62.

Note: You can also use the Cloud Configuration Tool to create an FTG Configuration (.tlx) file for FTG Mode via CPU configuration/cloning purposes, if desired (see pages 63 to 65). However, it is not possible to customize TV setup menu settings in the Cloud Configuration Tool. If you wish to include customized TV setup menu settings in the TV configuration, in addition to the channel lineup and Installer Menu settings, perform the Master TV Setup procedure to create a Clone (.tlx) configuration file.

Before You Begin

- It is recommended that you disconnect all Aux inputs if you intend to run Auto Tuning (Channel Search). Under certain conditions, Auto Tuning is disabled if there is an Aux input active.
- A Clone (.tlx) file comprises Installer Menu settings, IP Environment Menu settings (with the exception of unique TV attributes and settings), and all TV sources’ (analog, digital, AV, HDMI, etc.) clonable setup menu settings. See also “Clonable TV Setup Menu Features” list below.
- If the “.tlx” file (either a Clone or FTG Configuration file) to be imported on the Target TV(s) contains an FTG Channel Map, the Target TV(s) will be configured for FTG Mode via CPU, though as part of the import process, depending on the types of channels included in the Channel Map, you may have the option to select either logical or physical channel tuning. If you would like the Target TV(s) to remain in Pass-through Mode, the “.tlx” file should not include an FTG Channel Map.

Clonable TV Setup Menu Features

<p>Picture</p> <ul style="list-style-type: none"> Smart Picture Mode Picture Mode Settings <p>Sound</p> <ul style="list-style-type: none"> Smart Sound Mode Sound Mode Settings Volume Mode AV Sync. Adjustment 	<p>Channels</p> <ul style="list-style-type: none"> Channel Tuning Channel Manager Channel Label <p>General</p> <ul style="list-style-type: none"> Language Time & Date <ul style="list-style-type: none"> – Clock Mode (Auto/Manual) – Time Zone Timers (No Signal Power Off) Standby Light 	<p>Accessibility</p> <ul style="list-style-type: none"> Pointer Options Menu Transparency Closed Caption Audio Guidance TV Power Sound High Contrast
---	---	---

Note: Some menu options vary between digital and analog channels and Aux inputs.

Note: The Quick Settings Menu is initially displayed when you press the **MENU** key on the Installer Remote. Select the **All Settings**  menu icon to access the advanced TV setup menus. Several advanced settings are duplicated in the Quick Settings Menu.

Custom Master TV Setup Procedure

1. Turn ON the TV.

The next step depends on whether the LG First Use Wizard appears on the screen when you turn ON the TV:

- If the wizard is displayed, the TV is in the required factory default state. To continue with this procedure, exit the wizard, and then proceed to step 2.

Note: If desired, you may also use the LG First Use Wizard / Express Script to create an Express Script TV Setup for cloning purposes. See “Express Script” on pages 28 to 37 for further information. Note that TV setup menu customization via the Express Script is limited to Channels Menu options.

- If the wizard is not displayed, restore the TV to a factory default condition before continuing with this procedure. See Reference section, “Restoring Factory Defaults on the TV(s),” as necessary, for further information.

2. Set Installer Menu items.

This step provides specific instruction only on the Installer Menu items that should be set on a Master TV. Refer to pages 43 to 53 for detailed information on all Installer Menu items.

- Use the Installer Remote to access the Installer Menu (see “Accessing the Installer Menu” on page 43 for further information).
- Set Installer Menu item **003 BAND/AFC**, as appropriate.
 - Broadcast: Set to 0.
 - Cable: Set to 1 (default).
 - HRC: Set to 2.
 - IRC: Set to 3.
- Set Installer Menu item **027 HOSPITAL MODE**, as appropriate, to select the speaker configuration.
- Set any other Installer Menu items that affect your TV programming network to the required configuration. For example, enable/disable Aux inputs, set a Start Channel, etc.
- After you have adjusted all Installer Menu item settings as required, and if you do not need to configure any IP Environment settings (see note below), press **OK** once on the Installer Remote to save your changes; then, press **OK** again to exit the menu.

Note: If you intend to configure settings in the IP Environment Menu, which is accessible from the Installer Menu, you can proceed directly to step 3. All Installer Menu settings will be saved automatically when you access the IP Environment Menu.

3. Configure IP Environment settings.

Note: You cannot return directly to the Installer Menu from the IP Environment Menu; thus, you may wish to set all Installer Menu items as needed before you access the IP Environment Menu. Otherwise, you will need to reaccess the Installer Menu to set additional items.

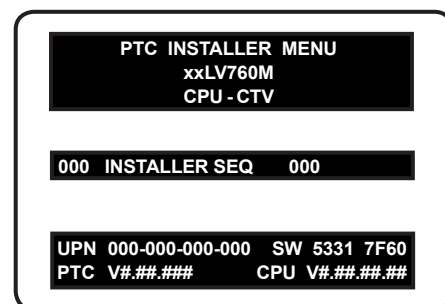

Typical Installer Menu



Adjust the values for these Installer Menu items, as required.

(Continued on next page)

Custom Master TV Setup (Cont.)

(Continued from previous page)

Navigate to Installer Menu item 119 DATA CHANNEL, and press **2-5-3 + MENU** to launch the IP Environment Menu. Then, complete network configuration as required. In particular, if you intend to use the Wi-Fi Zoning feature, you must configure the wireless network connection as part of the Master TV Setup. See “IP Environment Setup” on pages 70 to 79 for further information.

4. Set up TV features.

On-screen setup menus control the features of the TV. Press **MENU** on the Installer Remote, and select the **All Settings**  menu icon from the Quick Settings Menu to access the advanced TV setup menus. Then, set Picture, Sound, Channels, etc. options to the desired configurations. See “Clonable TV Setup Menu Features” list on page 54 and also notes below.

Note: If you intend to use the Zoning feature(s) on this TV, make sure to set the appropriate TV Zone # and/or Wi-Fi Zone # at this time. See Reference section, “Using the TV’s Zoning Features.”

Note: If desired and if appropriate, you can run Auto Tuning (see step 5) prior to completing this step.

5. (Optional) Run Auto Tuning.

If you are creating a Master TV Setup for cloning purposes and you want the Target TV(s) to remain in Pass-through Mode or Application Tuning Mode, as applicable, do NOT run Auto Tuning. If you export a Master TV Setup that includes an auto-tuned/edited channel lineup, thereby creating a Clone (.tlx) file with an FTG Channel Map, and then import the Clone file to a Target TV, this will put the Target TV in FTG Mode.

Note: When you import a Clone/Configuration (.tlx) file that contains an FTG Channel Map on a Target TV (for FTG Mode configuration), depending on the types of channels included in the Channel Map, you may have the option to select either logical or physical channel tuning. For either selection, the channel sequence will be based on the order in which the channels appear in the FTG Channel Map. You can view and/or edit the channel sequence in the Cloud Configuration Tool, as required.

- Use the Installer Remote to access the Channels Menu. Then, select **Channel Tuning** and follow the on-screen instructions to search for all available digital and analog channels.
- Use the **Channel Manager** option in the Channels Menu to edit the channel lineup, as necessary. Add/delete channels per your system requirements.

6. Verify the TV setup.

Make sure the TV features are set per your requirements. Also, if applicable, verify that the channel lineup is correct.

The Master TV Setup is now ready to be saved (exported) to a USB memory device. See “Cloning Procedures” on pages 57 to 62.

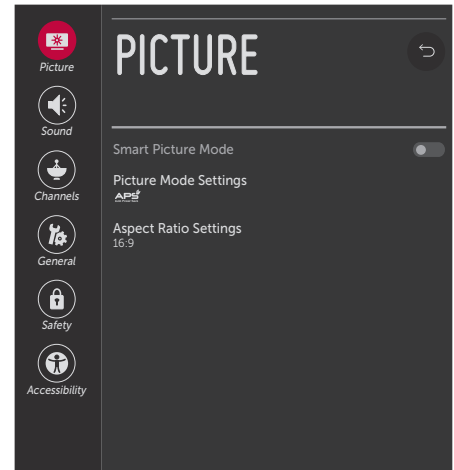

Use the TV setup menus to set the TV features to the desired configuration for the end user. This example illustrates the advanced TV setup menus.

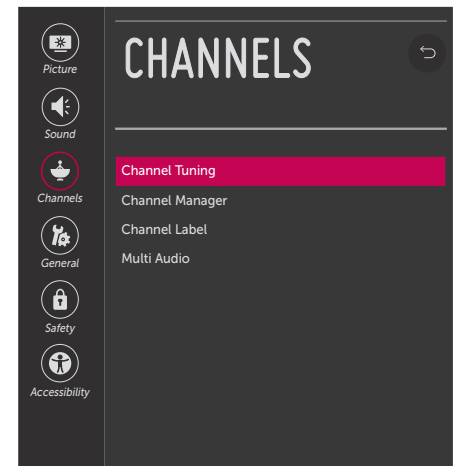

(Optional) Use Channels Menu options to run Auto Tuning and edit the channel lineup.

Cloning typically refers to the process of using a Master TV Setup to configure a Target TV. This section describes how to save (export) a Master TV Setup and then transfer (import) it to a Target TV using a USB memory device / Clone (.tlx) file.

You can also create an FTG Configuration (.tlx) file using the Cloud Configuration Tool and then use the Import Clone File procedure to transfer the configuration to Target TVs. Refer to “Creating an FTG Configuration File” on pages 63 to 65, as necessary.

Exporting a Clone File

This section describes how to use the TV Manager “Export Clone File” option to export Master TV Setup (including Express Script TV Setup) configuration to a USB memory device / Clone (.tlx) file.

Before You Begin

- Ensure the USB device has been formatted with FAT format.
- If applicable, complete the Custom Master TV Setup procedure (see pages 54 to 56).
- If you would like the Target TV(s) to remain in Pass-through Mode or Application Tuning Mode, as applicable, after the Clone file is imported, ensure the Master TV does not have an auto-tuned/edited channel lineup; otherwise, importing the exported file will result in the Target TV(s) being configured for FTG Mode.
- If you intend to use the TV's Zoning feature(s), make sure to set the appropriate TV Zone # and/or Wi-Fi Zone # as described in Reference section, “Using the TV's Zoning Features,” BEFORE performing the procedure below. Also, for Wi-Fi Zoning in particular, the TV's wireless network connection settings should be configured in the IP Environment Menu before exporting is initiated.
- It is not possible to clone a Master TV's clock. Either set a Target TV's clock manually, or use the Auto Clock setting in the TV setup menus.



Caution: Do not unplug the TV power cord or remove the USB memory device while exporting is in progress, as doing so may cause the TV to malfunction or harm the USB device, respectively.

Export Clone File Procedure

1. Ensure the Master TV is set up completely and turned ON.
2. Insert the USB memory device into the TV's USB port.
3. Press **MENU** on the Installer Remote to display the TV setup menus (TV is in Pass-through Mode) or the Function Menu (TV is already in FTG Mode).
4. (TV in Pass-through Mode only) From the Quick Settings Menu displayed at the right of the screen, select the **All Settings**  menu icon and press **OK** to access the advanced TV setup menus.
5. Use the arrow navigation keys to select/highlight either the **General** menu icon from the TV setup menus or the **Safety** menu icon from the Function Menu. Then, press the number “7” key a total of seven times to access the TV Manager.

(Continued on next page)

Cloning Procedures (Cont.)

(Continued from previous page)

Note: Ez Download is always selected by default when you initially access the TV Manager. Also, note that Diagnostics is for service use only.

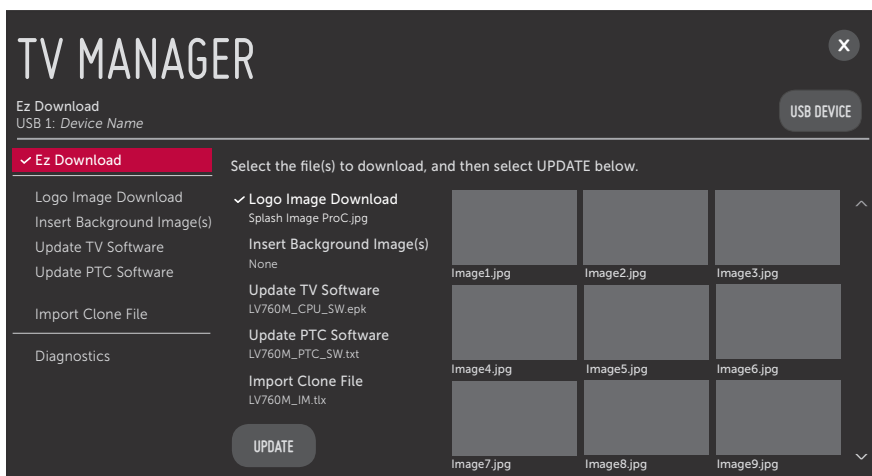

6. To gain access to the “Export Clone File” option in the TV Manager, key in the following number sequence on the Installer Remote: **9-8-7-6**.

7. Use the Up/Down arrow keys to select **Export Clone File**, and then press **OK**.

Clone filename parameters will be displayed on the screen.

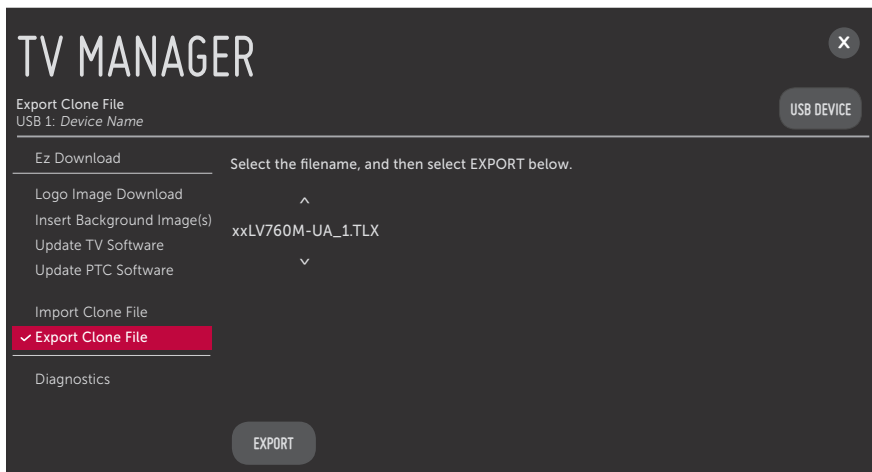

8. Modify the filename, as required. While the TV model element of the filename may not be changed, you can differentiate this Clone file from other LV760M Clone files by changing the numeric assignment appended to the end of the filename. Select/highlight the filename, and then use the Up/Down arrow keys on the Installer Remote to scroll through numeric assignments until the desired number is shown.

(Continued on next page)

(Continued from previous page)

9. When you are ready to continue, i.e., when you have selected the desired filename, press **OK** on the Installer Remote to select/activate the **EXPORT** button at the bottom of the screen, and then press **OK** on the Installer Remote once more to export the file.

Export progress will be displayed on the screen. This process may take a few minutes. Do NOT remove the USB device while exporting is in progress. When the export process is complete, an EXPORT COMPLETE pop-up banner will be displayed at the bottom of the screen.

10. Press **OK** to return to the TV Manager screen. To return to program viewing, select the  button at the top right corner of the screen.
11. Remove the USB memory device from the Master TV.

 **Note: If the Master TV has a channel lineup, during the export process, logical channel numbers are automatically assigned in ascending order, starting with 0 (zero), to the physical RF channels of the TV channel lineup to create an FTG Channel Map. See also note below.**

 **Note: If the exported Clone file is to be used for FTG Mode configuration (i.e., it contains an FTG Channel Map), it is highly recommended that you open the file in the Cloud Configuration Tool—BEFORE transferring (importing) the file to any Target TVs—to verify FTG Channel Map and FTG Installer Menu settings. This will also enable you to confirm channels and add channel attributes, labels, etc.**

Importing a Clone File

This section describes how to transfer (import) a Clone or Configuration (.tlx) file from a USB memory device to a TV using the TV Manager “Import Clone File” option. The “.tlx” file may be created either from a Master TV Setup that was saved (exported) from a Master TV or in the Cloud Configuration Tool.

Before You Begin

- Ensure the USB device has been formatted with FAT format.
- Avoid using special characters, such as ?, &, @, etc., in the Clone/Configuration (.tlx) filename.
- If you have initiated the EZ-Manager Wizard, you can use the wizard’s “USB Configuration” option to access the TV Manager and complete the import procedure, if desired (see “TV Configuration Options” and/or “USB Configuration” on pages 20 and 26, respectively, as necessary).
- You may also use the Ez Download utility to import the Clone/Configuration (.tlx) file. See “Ez Download Utility” on pages 39 to 42 for further information.
- If the Target TV is currently in Pass-through Mode and you intend to use the TV’s Zoning feature(s)—i.e., the Clone/Configuration (.tlx) file you are importing contains an FTG Channel Map and/or FTG profile(s) with TV Zone and/or Wi-Fi Zone assignments—make sure to set the appropriate TV Zone # and/or Wi-Fi Zone # in the TV when directed to do so in the procedure below. See Reference section, “Using the TV’s Zoning Features,” for further information.

(Continued on next page)

Cloning Procedures (Cont.)

(Continued from previous page)

- If you would like the Target TV(s) to remain in Pass-through Mode or Application Tuning Mode, as applicable, after the Clone/Configuration (.tlx) file is imported, ensure the “.tlx” file does not contain an FTG Channel Map; otherwise, the import procedure will result in the Target TV(s) being configured for FTG Mode.
- If a Clone (.tlx) file (exported Master TV Setup) contains an FTG Channel Map, the physical RF channels in the FTG Channel Map have been assigned logical channel numbers (see “Exporting a Clone File” above). When you import the Clone file with the FTG Channel Map on the Target TV(s), you will have the option to select either logical or physical channel tuning. Even if you select physical channel tuning, the (list of) physical RF channels in the FTG Channel Map will remain in logical order.
- If an FTG Configuration (.tlx) file (created in the Cloud Configuration Tool) contains an FTG Channel Map, each logical channel number in the FTG Channel Map has been assigned a physical RF channel, an IP channel, or an Aux input (the latter designated by 130-0 through 137-0—see also Reference section, “TV Aux Input Configuration”).

Note: If the FTG Channel Map includes RF channels and Aux inputs *only*, when you import the FTG Configuration file on the Target TV(s), you will have the option to select either logical or physical channel tuning. If you select physical channel tuning, the physical RF channels and Aux inputs in the FTG Channel Map will remain in logical order. Physical channel tuning is not available when the FTG Channel Map includes IP channels.

- If the Clone/Configuration (.tlx) file was edited/created in the Cloud Configuration Tool, it may contain multiple zoned FTG Installer Menu profiles for different TV models. Make sure it includes the appropriate Installer Menu profile(s) for the Target TV(s) before performing the procedure below.

 **Caution: Do not unplug the TV power cord or remove the USB memory device while importing is in progress, as doing so may cause the TV to malfunction or harm the USB device, respectively.**

Import Clone File Procedure

1. Turn ON the Target TV.
2. The next step depends on whether the LG First Use Wizard appears on the screen when you turn ON the TV:
 - If the wizard is displayed, you can complete the import procedure via the EZ-Manager Wizard, as indicated above (see “Before You Begin”). However, to continue with this procedure and access the “Import Clone File” option from the TV menus, exit the First Use Wizard. Then, continue with step 3.
 - If the wizard is not displayed, go directly to step 3.
3. If applicable (see also “Before You Begin” above), make sure to set the appropriate TV Zone # and/or Wi-Fi # in the Target TV at this time.

(Continued on next page)

(Continued from previous page)



Note: In order for the proper TV Zone and/or Wi-Fi Zone profile data to be applied, the appropriate TV Zone # and/or Wi-Fi Zone # must be set in the Target TV BEFORE importing is initiated.

4. Insert the USB memory device with the Clone/Configuration (.tlx) file into the USB port on the Target TV.
5. Press **MENU** on the Installer Remote to display the TV setup menus (TV is in Pass-through Mode) or the Function Menu (TV is already in FTG Mode).
6. (TV in Pass-through Mode only) From the Quick Settings Menu displayed at the right of the screen, select the **All Settings**  menu icon and press **OK** to access the advanced TV setup menus.
7. Use the arrow navigation keys to select/highlight either the **General** menu icon from the TV setup menus or the **Safety** menu icon from the Function Menu. Then, press the number “7” key a total of seven times to access the TV Manager.

Note: Ez Download is always selected by default when you initially access the TV Manager. Also note that Diagnostics is for service use only.

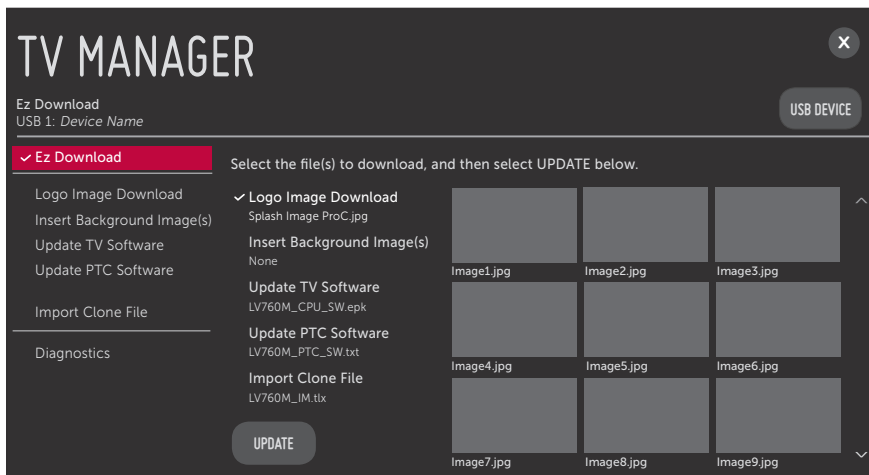

8. Use the Up/Down arrow keys to select **Import Clone File**, and then press **OK**.
A list of the “.tlx” files stored in the root folder of the USB memory device will be displayed on the screen (see example on following page).
9. Use the arrow keys on the Installer Remote to select/highlight the “.tlx” file to import, and then press **OK**.

Note: Filenames of exported Clone files are comprised of the TV model and a numeric element, for example, xxLV760M-UA_1.TLX.

(Continued on next page)

Cloning Procedures (Cont.)

(Continued from previous page)

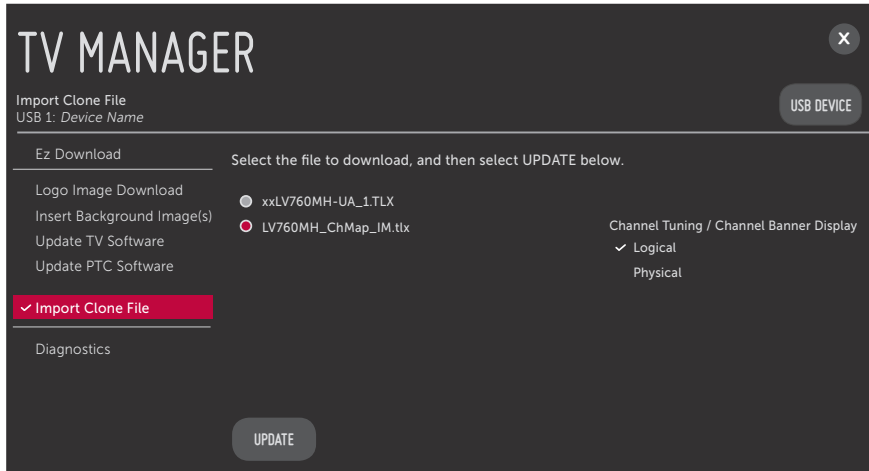

10. If the Clone/Configuration (.tlx) file includes an FTG Channel Map with RF channels and Aux inputs *only*, you can choose the format for the channel tuning/banner display. Use the arrow keys to select the desired Channel Tuning / Channel Banner Display option—either Logical or Physical—at the right side of the screen. A checkmark will appear at the left of the selected option. Logical tuning is selected by default.

Note: If an FTG Channel Map includes IP channels, only logical tuning is available. Also, if the “.tlx” file does not include an FTG Channel Map, the message, “No Channel Map in Clone file,” will be displayed at the right of the screen.

11. When you are ready to continue, select **UPDATE** on the screen and then press **OK** on the Installer Remote.

Import progress will be displayed on the screen. This process may take a few minutes. Do NOT remove the USB device while importing is in progress. When the import process is complete, an IMPORT COMPLETE pop-up banner will briefly be displayed at the bottom of the screen, and then, the TV will reboot.

12. Remove the USB memory device from the Target TV, and verify that the appropriate configuration is now resident on the Target TV.

Note: If the Target TV was previously in Pass-through Mode, and the Clone/Configuration (.tlx) file that was imported contained an FTG Channel Map, the Target TV CPU is now in FTG Mode. Upon restart, the TV tunes according to the Start Channel setting in the Installer Menu. If a Start Channel is specified, the TV will tune to that channel, though, in the case of FTG Mode configuration, a channel banner will only be displayed if the Start Channel is included in the FTG Channel Map (depending on your selection in step 10, the channel banner will display either the Start Channel's logical channel number or physical RF channel number). Otherwise, the TV will either return to the last channel tuned (TV in Pass-through Mode) or tune to the first channel in the FTG Channel Map (TV in FTG Mode). If the latter, remember that the channels in the FTG Channel Map are always arranged in logical order, regardless of your selection in step 10.

Cloud Configuration Tool Overview

This section provides an overview of LG's Cloud Configuration Tool web application, which is used for FTG Mode configuration. For best results, it is recommended that you access the Cloud Configuration Tool using one of the following web browsers: Google Chrome™ 51 or later or Mozilla Firefox® 47 or later.

Creating an FTG Configuration File

The subsections below briefly describe how to use the Cloud Configuration Tool to create an FTG Configuration (.tlx) file that can be used to configure the TV for FTG Mode. The Cloud Configuration Tool provides options both for advanced and new users. If you are not familiar with the steps to create an FTG Configuration file, you may choose a Wizard Setup that will guide you through the process of creating a new file. Refer to the **Cloud Configuration Tool User Guide** for further information.

Note: There is also an option to save (export) configuration from a TV, which may be desirable or required if you want to save customized TV setup menu settings to the FTG Configuration file and/or if you do not know the RF channels at the site. See “Exporting a Clone File” on pages 57 to 59 for further information.

Access the Cloud Configuration Tool and Select a Setup Option

1. Launch a web browser, and navigate to the following URL: **cct.procentric.tv**.
2. On the Welcome web page, make sure **North America** (default) is selected in the Select Your Region field, and then click on the **SELECT** button at the right of the field.

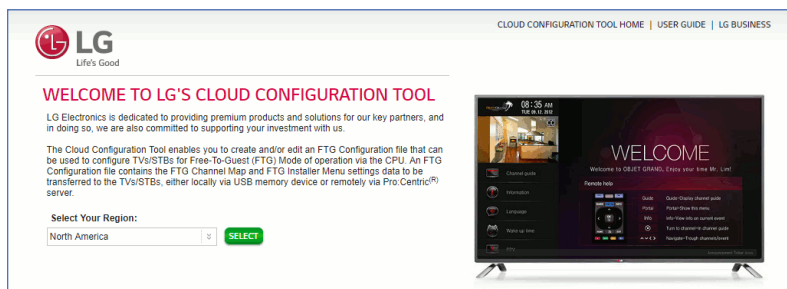

3. Once you select your region, you can choose the desired setup option, depending on your familiarity with the utilities and/or your file requirements:

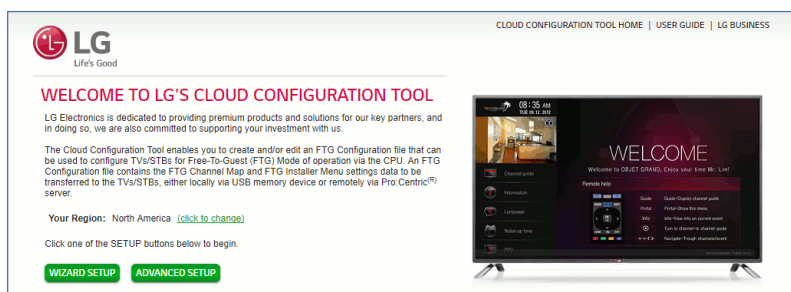

(Continued on next page)

Cloud Configuration Tool Overview (Cont.)

(Continued from previous page)

- If you are creating an FTG Configuration file from scratch and this is your first time using the Cloud Configuration Tool, you may wish to select the wizard setup, which will guide you through the essential steps of creating the file, i.e., creating the FTG Channel Map and/or the Installer Menu profile(s). To initiate the wizard setup, click on the **WIZARD SETUP** button.

On the next wizard page you will be prompted to indicate whether you would like to create an FTG Channel Map. Note that an FTG Channel Map is required for FTG Mode operation. Once you complete (or bypass) Channel Map activities and proceed to the next step, you will be prompted to indicate whether you would like to create an Installer Menu profile. The final wizard step enables you to review a summary of the FTG Configuration (.tlx) file contents and then save (export) the file to your PC.

- To view and/or base a new FTG Configuration file on an existing FTG Configuration (.tlx) file, or if you do not require wizard guidance to complete your activities, click on the **ADVANCED SETUP** button.

The File Manager web page will be displayed, and you have a number of options.

The following procedure provides an overview of the Advanced Setup. Refer to the **Cloud Configuration Tool User Guide** for further information on both the Wizard Setup and the Advanced Setup.

Advanced Setup Overview

1. When you select **ADVANCED SETUP** from the Welcome page (see “Access the Cloud Configuration Tool and Select a Setup Option” above), the File Manager page is displayed (see example on page 66).
2. (Optional) If desired/appropriate, you may view and/or base the new FTG Configuration file on an existing FTG Configuration (.tlx) file:

- Click on the **BROWSE** button at the right of the Find File to Upload field, and select/double-click on the desired “.tlx” file. Then, click on the **UPLOAD** button below the Find File to Upload field.

Once the file is successfully uploaded, the Find File to Upload field is replaced with a Loaded From File summary of the file’s contents, including a Channel Map Summary, Installer Menu Summary, and Setup Menu Summary.

- Double-click on each item in the Loaded From File summary at the left of the page that you would like to copy to the FTG Configuration List at the right of the page. As you move your mouse over the contents of a summary field, the field will be highlighted in blue, and **»»»** arrows at the right of the field will indicate that the data may be copied to the FTG Configuration List.
- Edit the configuration of the items in the FTG Configuration List as well as the FTG Configuration List itself, as necessary, to create a new file.

Note: While Setup Menu profiles can be included in the new FTG Configuration file (i.e., the profile[s] can be copied to the FTG Configuration List), Setup Menu profiles are not available for editing. However, on the File Manager page, you may change the Zone assignment for a Setup Menu profile, as required, for those models on which the TV Zoning feature is supported.

Note: If desired, you can click on the **UPLOAD NEW FILE** button below the list of Loaded From File items to select a different existing FTG Configuration file. If you want to add Installer Menu and/or Setup Menu profiles from more than one existing file to the new FTG Configuration file, make sure to transfer the appropriate items from the currently uploaded file to the FTG Configuration List before uploading a different file.

(Continued on next page)

Cloud Configuration Tool Overview (Cont.)

(Continued from previous page)

3. If you need to edit the FTG Channel Map from an existing file (see previous step) or create a new FTG Channel Map, click on **CHANNEL MAP** in the menu options bar at the top left of the page to access the Channel Map web page (see example on page 67), and edit/create the FTG Channel Map. Up to 600 logical channels—combined total of both RF and IP mapped channels—can be defined in the FTG Channel Map.
4. (Optional) To load default FTG Installer Menu settings by model, click on **INSTALLER MENU** in the menu options bar at the top left of the page to access the Installer Menu web page (see example on page 69), select the desired model/chassis ID and the desired Zone, and then click on the **CREATE PROFILE** button to create a new profile.

The new model profile will be added to the Installer Menu Profile List at the top right of the page, and the Installer Menu items for the selected model will now be displayed on the lower half of the page. The Summary tab shows the features that are available for configuration. Click on any Installer Menu item in the Summary tab or a category (User, Tuning, Audio, etc.) tab to view and/or edit its parameters, as required.

Note: Unless you select a different Zone assignment when you create the new profile, the default Zone 0 is assigned automatically. See Reference section, “Using the TV’s Zoning Features,” for further information on the TV Zoning feature and setting the TV Zone # in the TV(s).

5. Click on **FILE MANAGER** in the menu options bar at the top left of the page to return to the File Manager web page. The FTG Configuration List will now be populated with summaries of the FTG Channel Map, FTG Installer Menu profile(s), and, if applicable, Setup Menu profile(s) you created or added in the previous steps. Review and edit the FTG Configuration List, as necessary.

Note: If you need to edit the Channel Map or an Installer Menu profile, double-click on the desired item to access the Channel Map page or the Installer Menu page, as applicable. When you return to the File Manager page, the FTG Configuration List is automatically updated with all Channel Map and Installer Menu changes. (Installer Menu and/or Setup Menu profile Zone assignments may be changed on the File Manager page.)

Note: To remove an individual item from the FTG Configuration List, click on the **X** at the right of the applicable item field. At the prompt for confirmation , either click **yes** to confirm and remove the item immediately, or click **no** to retain the item. To clear all current FTG Configuration List contents, click on the **CLEAR LIST** button at the bottom right of the FTG Configuration List.

6. Export the FTG Configuration List contents to an FTG Configuration (.tlx) file on the PC’s hard drive for later use:
 - Type a brief descriptive name in the File Name field at the bottom of the FTG Configuration List (avoid using special characters, such as ?, &, @, etc.).
 - Click on **EXPORT FILE**.
 - In the Save As window (if applicable—see note below), select the desired location to which to export the file (you can also edit the file name here, if necessary), and click **Save**.

Note: Depending on the browser you are using and its current settings, files may automatically be saved to the “Downloads” or another designated folder on your PC. If you want to be able to select the folder in which to save the FTG Configuration file, check your browser settings.

7. Transfer the FTG Configuration (.tlx) file to a USB memory device, and proceed to “Importing a Clone File” on pages 59 to 62 to transfer the FTG Configuration file to an LV760M TV.

Cloud Configuration Tool Overview (Cont.)

File Manager Web Page Overview

The File Manager page (displayed after you select ADVANCED SETUP from the Welcome page) enables you to compile, modify, and save (export) FTG Configuration (.tlx) files. The following example provides an overview reference of the functions available on the File Manager page.

Data contained in uploaded FTG Configuration (.tlx) file. Users may choose to copy some or all of this data to the FTG Configuration List.

Data to be saved in the FTG Configuration (.tlx) file. This data may include contents transferred from an uploaded file and/or Channel Map/ Installer Menu contents created or modified in the Cloud Configuration Tool.

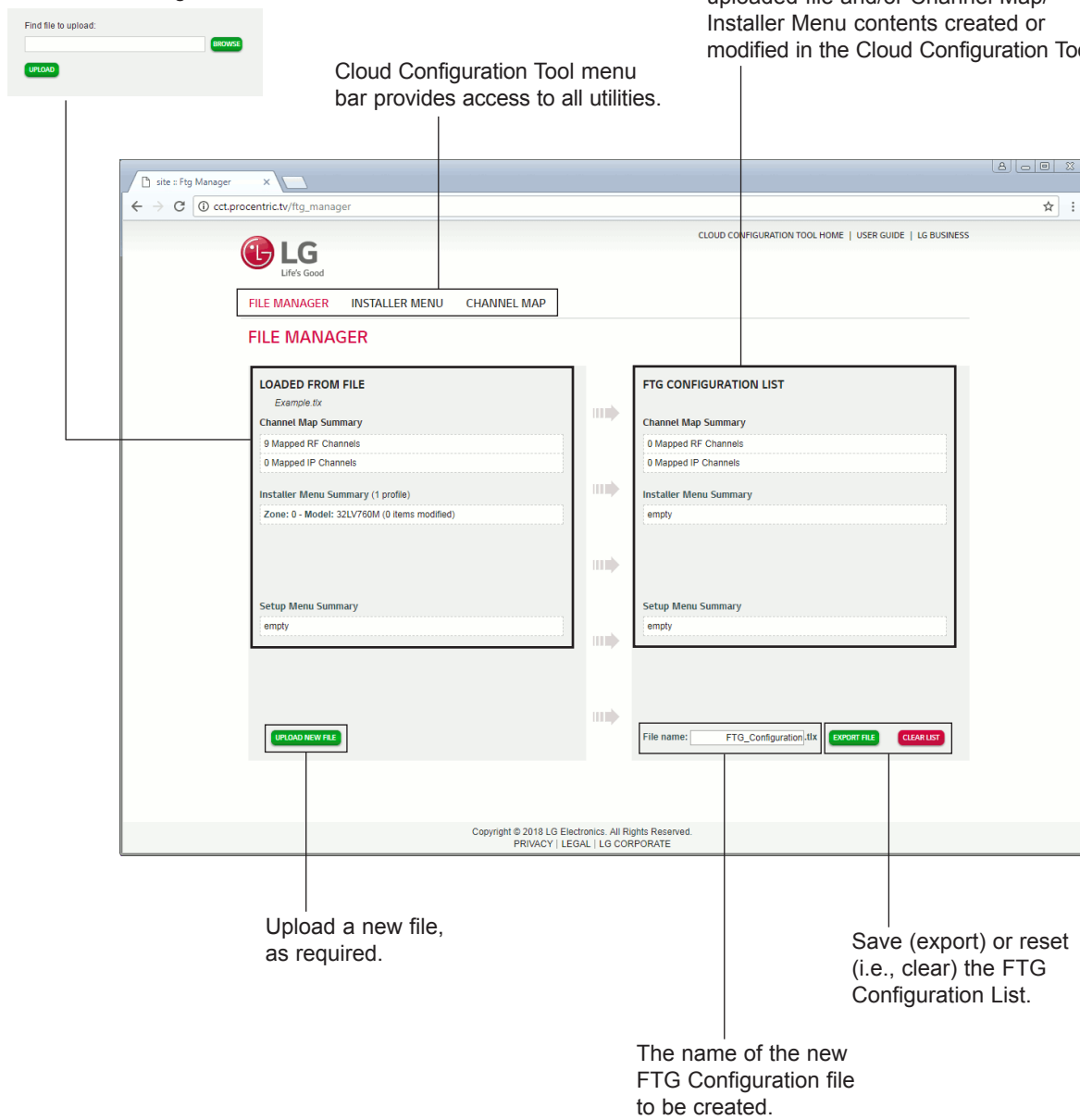

Cloud Configuration Tool Overview (Cont.)

Channel Map Web Page Overview

On the Channel Map page, you can create, view, and edit a Logical Channel Map.

Search for existing channels or clear the FTG Channel Map.

(Advanced Setup only) Cloud Configuration Tool menu bar provides access to all utilities.

Click the appropriate button to add a new RF or IP channel to the FTG Channel Map.

(Wizard Setup only) Proceed to next step.

The screenshot shows the 'CHANNEL MAP' web page. At the top, there is a navigation bar with 'FILE MANAGER', 'INSTALLER MENU', and 'CHANNEL MAP'. Below this is a search bar labeled 'CHANNEL MAP Search: (enter Logical or Label)' with a 'CLEAR CHANNEL MAP' button. To the right of the search bar are two buttons: 'RF CHANNEL' and 'IP CHANNEL'. Further right is a 'NEXT STEP' button. The main content is a table with the following columns: Logical, Channel Icon, Label, RF IP Address, Major IP Type, Minor IP Port, PLP ID, Prog #, Source Address, Attribute, Restricted from Zones, and Actions. The table contains several rows of channel data, including CBS, NBC, CNN HD, ABC HD, PBS, History, and Discovery. Each row has an 'Actions' column with icons for edit and delete. At the bottom of the page, there is a copyright notice: 'Copyright © 2018 LG Electronics. All Rights Reserved. PRIVACY | LEGAL | LG CORPORATE'.

Logical	Channel Icon	Label	RF IP Address	Major IP Type	Minor IP Port	PLP ID	Prog #	Source Address	Attribute	Restricted from Zones	Actions
1		CBS	2	2	0				Encrypted OSD	No	
2		NBC	20	20	5				Encrypted OSD	No	
3		CNN	01	01	1				Encrypted OSD	No	
4		ABC	18	18	1				Encrypted OSD	No	
5		PBS	19	19	3				Encrypted OSD	No	
6		History	06	06	2				Encrypted OSD	No	
7		Discovery	50	50	2				Encrypted OSD	No	
91	no logo	Video	72	72	47				Encrypted OSD	No	
93	no logo	HDMI 1	133	133	0				Encrypted OSD	No	

Click the appropriate icon to either edit an existing Logical Channel's data (see below) or remove a channel from the FTG Channel Map.

Cloud Configuration Tool Overview (Cont.)

The following example illustrates the fields that define the channel.

Select a channel icon (select "No Logo" if applicable), and/or enter a custom channel label.

As applicable, assign the RF, Major, and Minor channel numbers and PLP ID or enter the IP Address, Type, IP Port, and Program # data for the channel.

Set Zone restriction(s) per channel. Zones you select will be listed in the Restricted from Zones column. See Reference section, "Using the TV's Zoning Features," for further information.

Logical	Channel Icon	Label	RF IP Address	Major	Minor	PLP ID	IP Type	IP Port	Prog #	Source Address	Attribute	Restricted from Zones	Actions
0	no logo	17 Character Limit	1	1	0						<input type="checkbox"/> Encrypted <input checked="" type="checkbox"/> OSD <input type="checkbox"/> Blank Video	<input type="checkbox"/> Zone 1 <input type="checkbox"/> Zone 2 <input type="checkbox"/> Zone 3 <input type="checkbox"/> Zone 4 <input type="checkbox"/> Zone 5 <input type="checkbox"/> Zone 6 <input type="checkbox"/> Zone 7 <input type="checkbox"/> Zone 8	<input type="button" value="SAVE"/> <input type="button" value="CANCEL"/>

Enter a logical channel number.

Set channel attributes. Check/select Encrypted, OSD, or Blank Video.

After adding a new channel or editing an existing channel, save or cancel the changes.

Note: The application of FTG Channel Map Zone restrictions in the TV (see Restricted from Zones section in this screen) depends on the setting of Installer Menu item 027 HOSPITAL MODE (see item 027 description on page 49 for further details). If Installer Menu item 027 is set to 0, Hospital Mode is disabled, and TV Zoning / FTG Channel Map Zone restrictions may be set, as in Lodging models (see also Reference section, "Using the TV's Zoning Features"). When Hospital Mode is enabled, you can use Zones 1 to 4 to create custom channel lineups for Channel Banks 1 to 4 (see also "Channel Banks Overview" on pages 36 to 38). In the latter case, a checked Zone Restriction (1 to 4) checkbox means that the selected channel is "deleted" from the same numbered channel bank.

Cloud Configuration Tool Overview (Cont.)

Installer Menu Web Page Overview

(Advanced Setup only) Cloud Configuration Tool menu bar provides access to all utilities.

Load default Installer Menu for selected model. Assign Zone as applicable. Once you click on CREATE PROFILE, this Installer Menu profile will be listed under the Installer Menu Profile List, and Installer Menu items will be displayed on the lower half of the page.

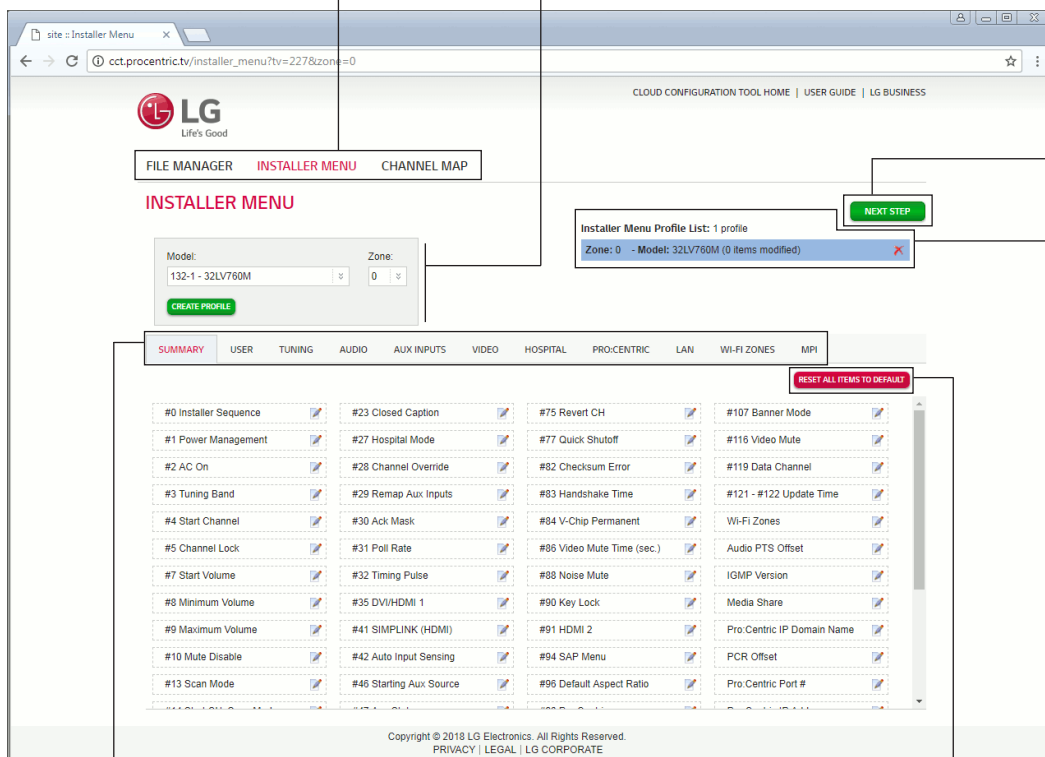

(Wizard Setup only) Proceed to next step.

Installer Menu profiles to be included in the FTG Configuration (.tix) file. The currently active profile is highlighted.

Select tabs for categories of Installer Menu items to set up TV.

Reset default values for currently active configuration profile. A RESET button is also available within each category tab.

Note: The Pro:Centric tab enables you to set up Pro:Centric-specific parameters, the LAN tab enables you to set up a variety of LAN features, and the Wi-Fi Zones tab enables you to set up Wi-Fi Zones. Refer to the **Cloud Configuration Tool User Guide** for further information. Also, see Reference section, "Using the TV's Zoning Features," for additional information on Wi-Fi Zoning.

IP Environment Setup

The IP Environment Menu enables you to set up the network features of the TV. If you intend to create a Master TV Setup for cloning purposes (see Master TV Setup procedure on pages 54 to 56), all IP Environment settings, with the exception of Wired Network Connection settings, LG Connect settings, the TV name (editable in the Media Share Menu), DIAL settings, and SoftAP settings, may be cloned.

Note: With the exception of Network Setting configuration, the IP Environment settings are editable (with the Installer Remote) only if the TV is in Pass-through Mode and read-only when the TV is not in Pass-through Mode.

Accessing the IP Environment Menu

Note: When you enter the IP Environment Menu, the Installer Menu is exited (all current settings are saved automatically upon exit). If you are also in the process of updating Installer Menu items, you may wish to set all items as needed before you access the IP Environment Menu. Otherwise, after exiting the IP Environment Menu, you will need to reaccess the Installer Menu to set additional items.

1. Use the Installer Remote to access the Installer Menu (see “Accessing the Installer Menu” on page 43 for further information).
2. Navigate to Installer Menu item 119 DATA CHANNEL, and press **2-5-3 + MENU** to launch the IP Environment Menu.

Use the Up/Down arrow keys on the Installer Remote to select the desired menu option and then press **OK**. Refer to the following sections for information on each of the IP Environment setup options.

When you have completed your IP Environment configuration as required, press **EXIT** or **↩** on the Installer Remote to exit the IP Environment Menu.

Network Configuration

This section describes each of the options available in the Network Menu (see example at right). Refer to the appropriate subsection(s) on the following pages.

 **Note: If you intend to use the Wi-Fi Zoning feature with cloning configuration, you must configure the wireless network connection as part of the Master TV Setup. See “Configuring a Wi-Fi Network Connection” on page 72 for further information.**

Accessing the Network Menu

With the IP Environment Menu on display, use the arrow keys on the Installer Remote to select the **Network** menu option. Then, press **OK**.

Note: The TV’s MAC address is displayed at the top of the Network Menu screen and cannot be modified.

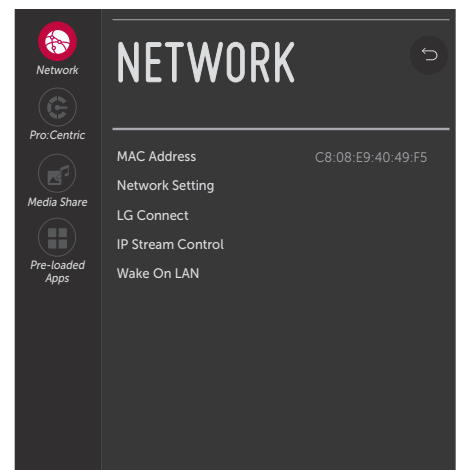

Configuring a Wired Network Connection

Note: If desired, you can configure both wired and wireless connections. However, note that a wired connection is always prioritized over a wireless connection. That is, when the TV is turned OFF and then back ON, if a Local Area Network (LAN) is detected by the TV, the TV will default to the wired connection. If the LAN cable is removed, the TV will then attempt to establish the wireless connection. Whenever the TV is reconnected to the LAN, the TV will re-establish the wired connection.

1. Connect the appropriate cable between the TV and the network.
2. With the Network Menu on display, use the arrow keys on the Installer Remote to select **Network Setting**. Then, press **OK**. A second Network screen (see example at right), with Wired and Wi-Fi Connection setup options, will be displayed.

By default, the TV uses DHCP, and if a LAN is detected, the TV will request an IP address from the DHCP server on the network as soon as you select “Network Setting” above. If the TV is able to connect to the network, a “Connected to Internet” message will be displayed below the Wired Connection field.

3. If the network is not configured for DHCP or you want to specify static IP configuration data or you would like to change the network configuration from Manual to Automatic, edit the IP data for this TV as follows:
 - In the second Network screen, select **Wired Connection** and press **OK**. Then, in the Wired screen, select **Edit** (if not already selected) and press **OK**.
 - In the Edit IP screen, select or de-select the “Set Automatically” checkbox, as required. A checkmark indicates that Automatic configuration is enabled.
 - To manually edit the IP data, for each data entry field: Use the arrow keys on the Installer Remote to select the field and press **OK**. You can use the number keys on the Installer Remote to direct enter numeric values or use the arrow keys to select the appropriate numbers from the pop-up virtual keyboard displayed at the bottom of the screen. (Note, however, that you must use the dot “.” key from the virtual keyboard to separate each octet of an IP address.) When you are done, select **Enter** from the virtual keyboard, and then press **OK** on the Installer Remote.
 - When all Edit IP fields are set as required, use the arrow keys on the Installer Remote to select **Connect** and press **OK**.

At the top of the screen, you will see a progress display that indicates status as each network element is confirmed (see example at right).

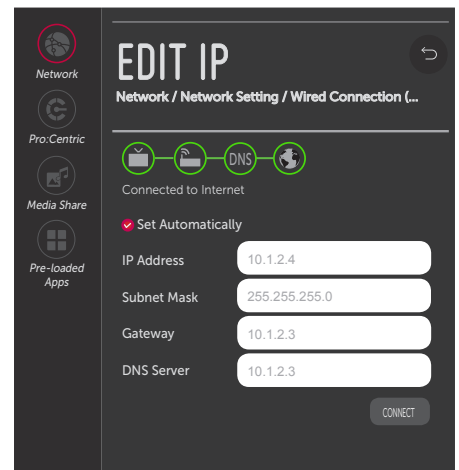
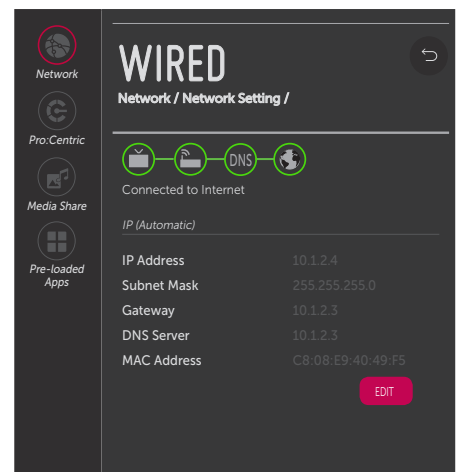
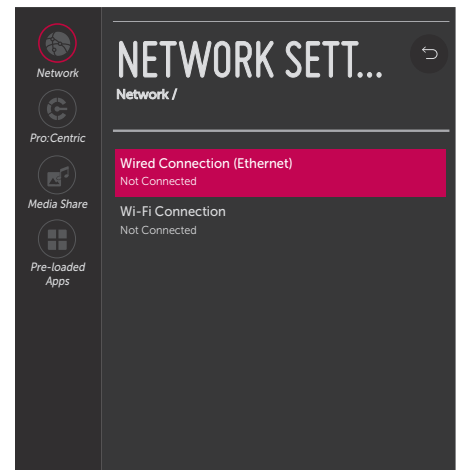

(Continued on next page)

IP Environment Setup (Cont.)

(Continued from previous page)

If the network is connected successfully, a “Connected to Internet” message will appear just below the progress display. If the network connection is not successful, the progress display will identify the network element in which the connection failed. Check your cabling and/or verify the configuration data, as necessary.

4. Once the wired network configuration is complete, use the arrow keys on the Installer Remote to return to the IP Environment Menu, as necessary, or press ↵ to return to the previous Network Menu level(s) and/or exit the IP Environment Menu.

Configuring a Wi-Fi Network Connection

1. With the Network Menu on display, use the arrow keys on the Installer Remote to select **Network Setting**. Then, press **OK**.
2. A second Network screen (see example at right), with Wired and Wi-Fi Connection setup options, will be displayed. Select **Wi-Fi Connection** and press **OK**.
3. In the Wi-Fi screen, available access points are listed in the top half, while additional menu options are listed in the bottom half, of the screen. Use the arrow keys on the Installer Remote to select the desired access point, or select the type of wireless connection to configure (see descriptions below). Then, press **OK**.
 - Hidden network: Direct enter the SSID of an access point whose SSID has not been enabled for broadcast (i.e., the access point does not appear in the list of access points).
 - WPS PBC: Connect to a network via an access point that is enabled for PBC.
 - WPS PIN: Complete network/PIN verification via the access point web interface.

Make sure you have the network security password/PIN available if you are attempting to connect to a secured network.

4. Follow the on-screen instructions to complete the appropriate network configuration. Use the Installer Remote to navigate between fields and make entries, etc.

Note: As with a wired connection, you will have the option to specify static IP configuration data for this network connection. Once the initial connection is established, you can select **Advanced Wi-Fi Settings** (initially greyed out) at the bottom of the Wi-Fi screen to view the IP configuration data. In the Advanced screen, select **Edit** and press **OK**, and then modify the IP data, as required. See step 3 of the wired connection procedure above for further information on the Edit IP screen fields.

5. Once the wireless network configuration is complete, use the arrow keys on the Installer Remote to return to the IP Environment Menu, as necessary, or press ↵ to return to the previous Network Menu level(s) and/or exit the IP Environment Menu.

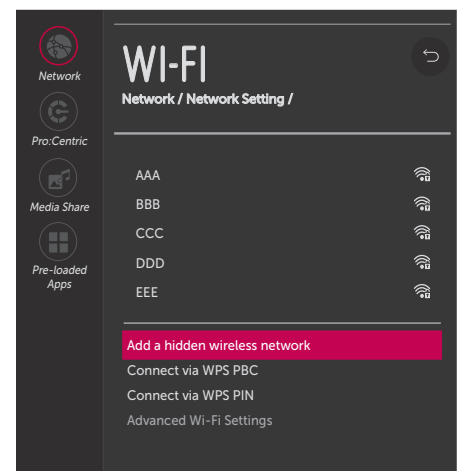
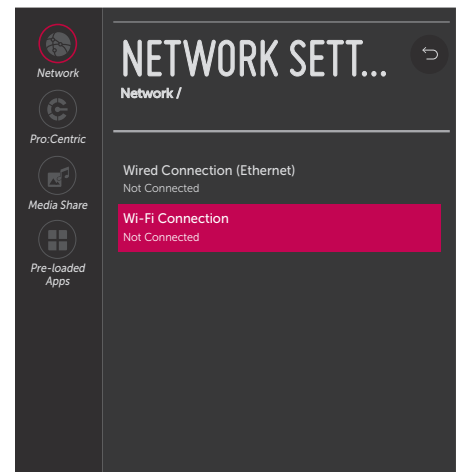

LG Connect

LG Connect allows guests to use LG webOS Connect apps to pair the TV with a mobile device, which can then be used to access and control TV features (i.e., the device may be used as a mobile remote). LG Connect requires that both the TV and the mobile device be on the same Wi-Fi network.

This menu enables you to turn LG Connect either ON (default) or OFF. It also allows you to delete all existing stored device pairings.

1. With the Network Menu on display, use the arrow keys on the Installer Remote to select **LG Connect**. Then, press **OK**.
2. When you initially access the LG Connect screen, the OFF/ON toggle button at the top right of the screen is selected/highlighted by default. Press **OK** on the Installer Remote to turn LG Connect ON.
3. If you wish to delete all stored device pairings, turn LG Connect ON as described in the previous step (if it is not ON already), select/highlight the **REVOKE PAIRING** button, and press **OK** on the Installer Remote. At the prompt for confirmation, either select **YES** and press **OK** to delete the list of paired devices, or select **NO** and press **OK** to return to the LG Connect Menu without deleting stored pairings.

Note: See “Configuring a Wi-Fi Network Connection” on the previous page for information configuring the wireless network connection.

Note: The REVOKE PAIRING button is only available/displayed when LG Connect is turned ON.

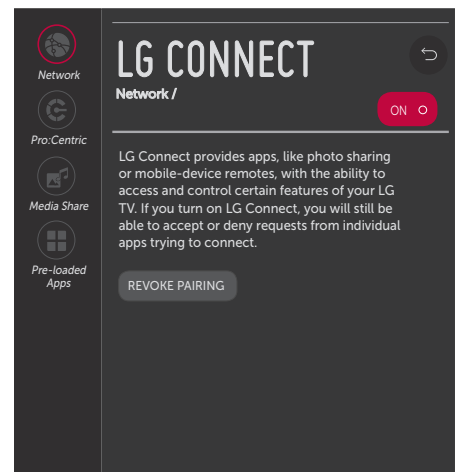

IP Stream Control

If necessary, due to an audio and/or video stream delay, IP Stream Control options enable you to compensate for synchronization irregularities by allowing audio PTS and video PTS offset modifications. This menu also enables you to specify the IGMP version (2 or 3). Note that any modifications to these settings should be performed by qualified personnel only.

1. With the Network Menu on display, use the arrow keys on the Installer Remote to select **IP Stream Control**. Then, press **OK**.
2. In the IP Stream Control screen, use the Up/Down arrow keys on the Installer Remote to select/highlight the appropriate field—Audio PTS Offset, Video PTS Offset, or IGMP Version—and then press **OK**.
3. If you are modifying an offset value, use the Left/Right arrow keys to select the appropriate value for the selected field. Offset values represent offset time in milliseconds (ms) and can be adjusted from -500 ms to +500 ms in 10 ms increments. When you are done, press **OK** on the Installer Remote.

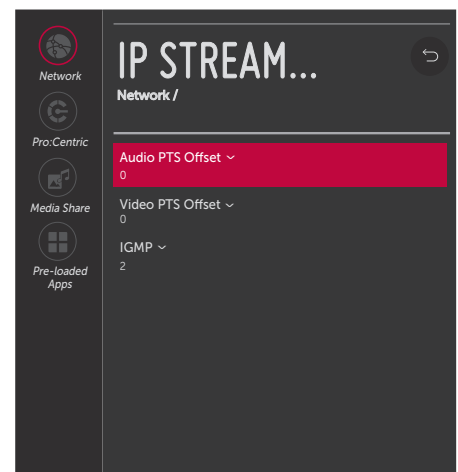

(Continued on next page)

IP Environment Setup (Cont.)

(Continued from previous page)

If you are modifying the IGMP version, use the Up/Down arrow keys to select the appropriate version number from the drop-down list of options, and then, press **OK**.

4. Once all modifications are completed as required, use the arrow keys on the Installer Remote to return to the IP Environment Menu, as necessary, or press **↵** to return to the Network Menu and/or exit the IP Environment Menu.

Wake On LAN Setup

The Wake On LAN feature enables the TV to receive software updates and/or be powered ON upon receipt of Magic Packet data via the wired LAN. To facilitate use of this feature, note that the appropriate wired connection must be made. This menu option enables you to specify Wake On LAN parameters.

1. With the Network Menu on display, use the arrow keys on the Installer Remote to select **Wake On LAN**. Then, press **OK**.
2. In the Wake On LAN screen, use the Up/Down arrow keys on the Installer Remote to select/highlight the WOL (Magic Packet) field (if it is not already selected) and press **OK**. Then, use the arrow keys to select the desired setting—Disabled, Update, or Power On—from the drop-down list of options.
3. Once you have made your selection, use the arrow keys on the Installer Remote to return to the IP Environment Menu, as necessary, or press **↵** to return to the Network Menu and/or exit the IP Environment Menu.

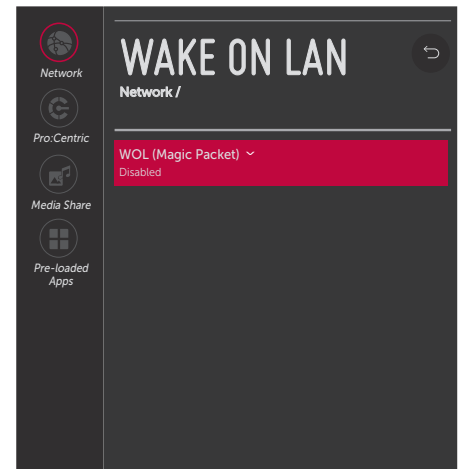

Pro:Centric Setup

Pro:Centric options enable you to configure the TV with the appropriate settings to connect to the Pro:Centric server. Use the Up/Down arrow keys on the Installer Remote to navigate between fields.

1. With the IP Environment Menu on display, use the arrow keys on the Installer Remote to select the **Pro:Centric** menu option. Then, press **OK**.
2. Select/highlight the **Media Type** field and press **OK** on the Installer Remote to display the drop-down list of options. Then use the Up/Down arrow keys to select either **RF** or **IP**, as applicable.

Note: If the Media Type has already been set in the EZ-Manager Wizard or Express Script, the specified value will be reflected in this field.

(Continued on next page)

(Continued from previous page)

3. Refer to the appropriate subsection below to configure the TV's Pro:Centric settings to match those of the Pro:Centric server.

While the Pro:Centric application itself is an additional feature (see step 4), the appropriate Pro:Centric server configuration must be completed to enable TV E-Z Installation (splash screen, configuration, and software/firmware) data downloads and, if configured, the Pro:Centric application download.

RF Configuration

For TVs in Pass-through Mode or FTG Mode via CPU, if the Data Channel is left at its default value (AUTO), the TV's Data Channel Auto Search feature will be enabled. See Installer Menu item 119 DATA CHANNEL description on page 53 for further information.

To change the Data Channel setting, select/highlight the **Data Channel** field and press **OK** on the Installer Remote. Then, use the Up/Down arrow keys to select either **MANUAL** or **AUTO** from the drop-down list of options.

When the Data Channel field is set to "MANUAL," a data entry field is available on the screen, and you can specify the RF channel number that will be used by the Pro:Centric server as its data channel. The Data Channel value can be set from 0 (disabled) to 135.* Use the arrow keys on the Installer Remote to select the Data Channel data entry field and press **OK**. You can then use the number keys on the Installer Remote to direct enter the Data Channel, or you can use the arrow keys to select the appropriate number(s) from the pop-up virtual keyboard displayed at the bottom of the screen. When you are done, select **Enter** from the virtual keyboard, and then press **OK** on the Installer Remote.

Note: If the Data Channel has already been set in the Installer Menu (Installer Menu item 119) or in the EZ-Manager Wizard or Express Script, the specified channel will appear in the Data Channel data entry field. If you change the Data Channel in this menu, Installer Menu item 119 will now show the value you entered here.

IP Configuration

Note: If the server IP address and port number or domain name have already been set in the EZ-Manager Wizard or Express Script, the specified data will be reflected in the fields displayed.

Note: Setting the Media Type to "IP" automatically sets item 119 DATA CHANNEL in the Installer Menu to 253. You cannot alter this setting unless you revert Media Type to "RF." Also, it is not possible to direct enter "253" in the Installer Menu.

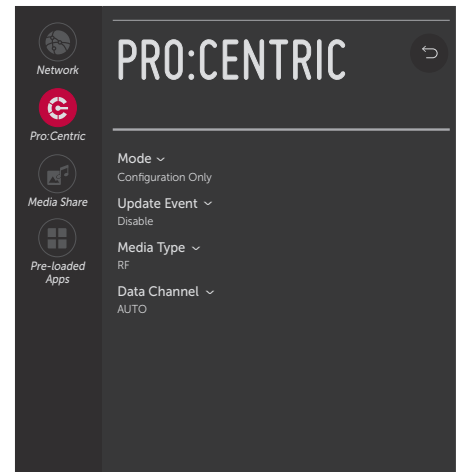

Note: By default, the Pro:Centric Menu initially shows RF configuration fields. When "IP" is selected as the Media Type, Server Address and either IP Address and Port Number or Domain Name and Port Number fields appear on the screen (in place of the Data Channel field).

(Continued on next page)

* PCS150R and later Pro:Centric servers do not support HRC or IRC cable channel frequencies.

IP Environment Setup (Cont.)

(Continued from previous page)

a) The Server Address field provides the option to specify the domain name of the Pro:Centric server instead of the server's IP address. Select/highlight the **Server Address** field and press **OK** on the Installer Remote. Then, use the Up/Down arrow keys to select either **IP Address** or **Domain Name** from the drop-down list of options for defining the server.

b) Depending on your selection in the previous step, either:

- Enter the Pro:Centric server IP address in the IP Address field. The IP address must match the IPv4 multicast address that is set in the Pro:Centric server.
- Enter the Pro:Centric server domain name in the Domain Name field. Note that in order for the domain name to be resolved to an IP address, there must be a DNS entry for the domain name.

For each data entry field: Use the arrow keys to select the field and press **OK**. Then, you can either use the number keys on the Installer Remote to direct enter data values, or you can use the arrow keys to select the appropriate number(s)/alphanumeric character(s) from the pop-up virtual keyboard displayed at the bottom of the screen. When you are done, select **Enter** from the virtual keyboard, and then press **OK** on the Installer Remote.

c) Enter the Pro:Centric server port number in the Port Number field. The port number must match the port number that is set in the Pro:Centric server.

4. Select/highlight the **Mode** field and press **OK** on the Installer Remote to display the drop-down list of options. Then, use the Up/Down arrow keys to select the appropriate Pro:Centric Application Mode setting—**Configuration Only**, **FLASH**, **GEM**, or **HTML**. If the Pro:Centric Application Mode is set to "Configuration Only," Pro:Centric application data will not be downloaded.

Note: If the mode has already been set in the Installer Menu (item 098 PRO:CENTRIC) or in the EZ-Manager Wizard or Express Script, the specified mode will be reflected in this field. If you change the mode in this menu, Installer Menu item 098 will now reflect the value you selected here.

5. Select/specify the appropriate Update Event setting(s), as required. Based on Update Time settings, the Wake For Update feature wakes the TV once daily to check for, and if applicable, download updates from the Pro:Centric server. See Installer Menu item 121 UPDATE TIME HR description on page 53 for additional information on Wake For Update functionality.

- Select/highlight the **Update Event** field and press **OK** on the Installer Remote. Then, use the Up/Down arrow keys to select either **Enable** or **Disable** from the drop-down list of options. When Update Event is set to "Enable," an Update Time field is displayed on the screen.
- If Update Event is enabled, set the Update Time as required. Use the arrow keys on the Installer Remote to select/highlight the Update Time field, and then press **OK**. Hour, Minute, and Meridiem fields will be displayed. Select each field in turn and specify the appropriate Wake For Update time, as desired. Note that the Update Time set in this menu is based on a 12-hour clock. Ensure the meridiem (AM/PM) specification is set accordingly.

6. Once all fields are completed as required, use the arrow keys on the Installer Remote to return to the IP Environment Menu, as necessary, or press **↵** to exit the IP Environment Menu.

Media Share Setup

The Media Share Menu allows you to enable the following Media Share features on this TV:

- LG Smart Share®: Allows guests to use the TV to access and view data shared either by wired DLNA Certified® devices connected to the same LAN as the TV or by wireless LG devices using LG's Smart Share application with Wi-Fi Direct®.
- Screen Share: Enables screen sharing with a Miracast® or Wireless Display (WiDi) capable device (e.g., a laptop with Intel® hardware).
- Media Renderer: Enables the TV to act as a media renderer device to receive content from DLNA Certified devices on the same network.
- DIAL (Discovery and Launch): Allows guests to play selected application media on the TV from a device with DIAL capability. The device may be used to cast any application for which a TV-compatible application has been created/selected for inclusion in the Pre-loaded Apps Menu (e.g., YouTube—see also “Pre-loaded Applications” on page 79). Note that the device must be connected to the same network as the TV.
- SoftAP: Enables the TV to function as a 2.4 GHz wireless access point for up to five devices. Note that a wired network connection MUST be established in order for guests to use SoftAP.

Note: See also Reference section, “Using Media Share Features,” for additional information on these features.

1. With the IP Environment Menu on display, use the arrow keys on the Installer Remote to select **Media Share**. Then, press **OK**.
2. In the Media Share Menu, all features with the exception of SoftAP may be enabled or disabled as follows:
 - Use the Up/Down arrow keys on the Installer Remote to select/highlight the desired feature, and then press **OK**.
 - Then, use the Up/Down arrow keys to select either **Enable** or **Disable** from the drop-down list of options.
3. If you would like to enable SoftAP, complete the SoftAP access configuration as follows:
 - Select/highlight **SoftAP** and press **OK** on the Installer Remote.
 - When you initially access the SoftAP screen (see example at right), the OFF/ON toggle button at the top right of the screen is selected/highlighted by default. Press **OK** on the Installer Remote to turn SoftAP ON.

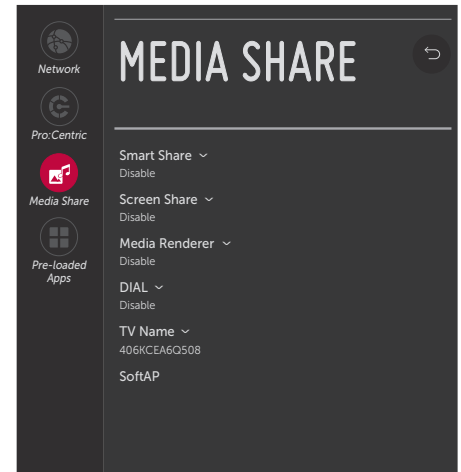

Note: Screen Share MUST be enabled in addition to Smart Share in order for guests to use Wi-Fi Direct.

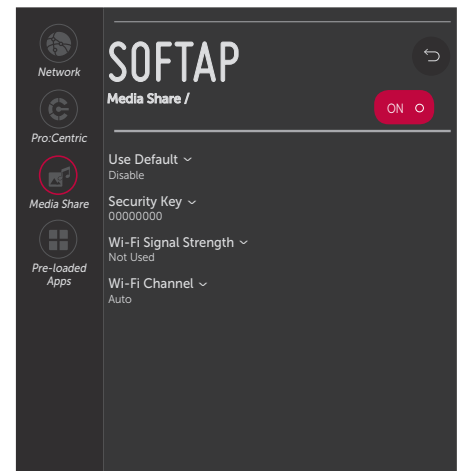

(Continued on next page)

IP Environment Setup (Cont.)

(Continued from previous page)

- To enable use of a randomly generated security key for SoftAP access, set the Use Default field to “Enable” (the Security Key field will subsequently be grayed out and the random security key will be displayed).
 - To specify your own security key for SoftAP access, set the Use Default field to “Disable.” Then, select the **Security Key** field and press **OK**. In the data entry field, you can use the number keys on the Installer Remote to direct enter a numeric security key, or you can use the arrow keys to select the appropriate alphanumeric characters—at least eight, but no more than 64—from the pop-up virtual keyboard displayed at the bottom of the screen. Note that the security key may not contain any special characters (;, /, \, @, etc.). When you are done, select **Enter** from the virtual keyboard, and then press **OK** on the Installer Remote.
 - Select the appropriate values in the Wi-Fi Signal Strength, and Wi-Fi Channel fields, as required.
4. If desired, you can specify a name for this TV so that it is easy to identify and differentiate from other TVs for which sharing has been/will be enabled.

Note: By default, the TV name is the TV’s serial number. However, if a room number is specified in the EZ-Manager Wizard or in the General Menu / Room Info screen, the TV name is changed to the room number.

To edit the TV name, use the Up/Down arrow keys to select the **TV Name** field, and then press **OK**. You can then use the number keys on the Installer Remote to direct enter a numeric TV name, or you can use the arrow keys to select the appropriate alphanumeric character(s) from the pop-up virtual keyboard at the bottom of the screen. When you are done, select **Enter** from the virtual keyboard, and then press **OK** on the Installer Remote.

5. Once all fields are completed as required, use the arrow keys on the Installer Remote to return to the IP Environment Menu, as necessary, or press **↵** to exit the IP Environment Menu.

Note: While Smart Share, Screen Share, and Media Renderer settings are clonable, DIAL and SoftAP settings, as well as the TV name cannot be cloned.

Pre-loaded Applications

This option allows you to select which of the pre-loaded application icons to display in the TV's Smart Launcher, which appears along the bottom of the screen.

When the Pro:Centric application is disabled, the Smart Launcher is available to end users via the PORTAL key on the remote control. The Smart Launcher is also available to end users via the SMART key on the remote control.

1. With the IP Environment Menu on display, use the arrow keys on the Installer Remote to select **Pre-loaded Apps**. Then, press **OK**.
2. In the Pre-loaded Apps screen, a list of available application options is displayed. Use the Up/Down arrow keys to highlight each application you wish to select or de-select, and press **OK** on the Installer Remote. When an application is selected, a checkmark is displayed at the left of the application name.

Note: Though not included in the application list on this screen, Screen Share and SoftAP (as Wi-Fi Service) applications are available in the Smart Launcher once they are enabled in the Media Share Menu. See "Media Share Setup" above.

3. When you are done selecting the pre-loaded application icons to be displayed in the Smart Launcher, as required, use the arrow keys on the Installer Remote to return to the IP Environment Menu, as necessary, or press **↩** to exit the IP Environment Menu.

Note: While pre-loaded application selections are clonable, it is not possible to edit pre-loaded application selections in the Cloud Configuration Tool. Thus, if a TV has already been configured for FTG Mode and you would like to add or remove applications, you will need to import a new ".tlx" file with the appropriate model profile. That is, you will need to use a Master TV of the same model to create and export a ".tlx" file with the desired pre-loaded application selections (along with any other applicable Installer Menu settings), which can be transferred (imported) to the Target TV.

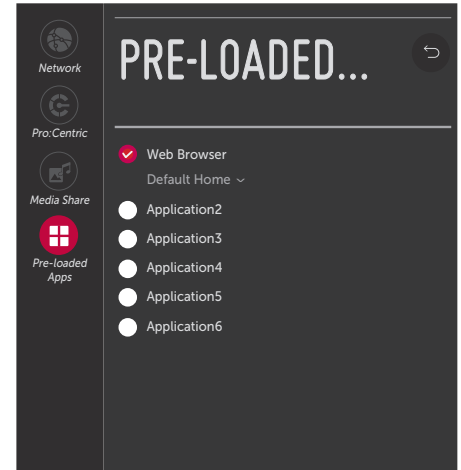

Notes:

- Make sure to select any application(s) that may be used in conjunction with the DIAL feature, if applicable.
- If desired, with the Web Browser application, you may specify the default home page.

Reference: Updating TV/PTC Software using a USB Memory Device

This section describes how to update TV (CPU) and/or PTC software using the TV Manager “Update TV Software” and/or “Update PTC Software” option(s), respectively, though you may also use the Ez Download utility to update software, if desired. See “Ez Download Utility” on pages 39 to 42 for further information.

Before You Begin

- Software update files must be stored in a folder named “LG_DTV” in the root directory of the USB memory device.
- Ensure the USB device has been formatted with FAT format.

Update the TV/PTC Software

Note: You can check the TV/PTC software versions by accessing the Installer Menu with the Installer Remote. See “Accessing the Installer Menu” on page 43 for further information. PTC and CPU versions are displayed in the Installer Menu footer.

Note for TV CPU Software Update only: If the TV detects a software file on the USB device, it will automatically display an Update TV Software screen, and if the file contains a later version of software than is currently running on the TV, you can start the software update from this screen (select **UPDATE** and press **OK**). Otherwise, you can exit the screen (select **CANCEL** and press **OK**), and access the TV Manager as described below.

1. Turn ON the TV, and then insert the USB memory device into the TV’s USB port.
2. Press **MENU** on the Installer Remote to display the TV setup menus (TV is in Pass-through Mode) or the Function Menu (TV is not in Pass-through Mode).
3. (TV in Pass-through Mode only) From the Quick Settings Menu displayed at the right of the screen, select the **All Settings**  menu icon and press **OK** to access the advanced TV setup menus.
4. Use the arrow navigation keys to select/highlight either the **General** menu icon from the TV setup menus or the **Safety** menu icon from the Function Menu. Then, press the number “7” key a total of seven times to access the TV Manager.

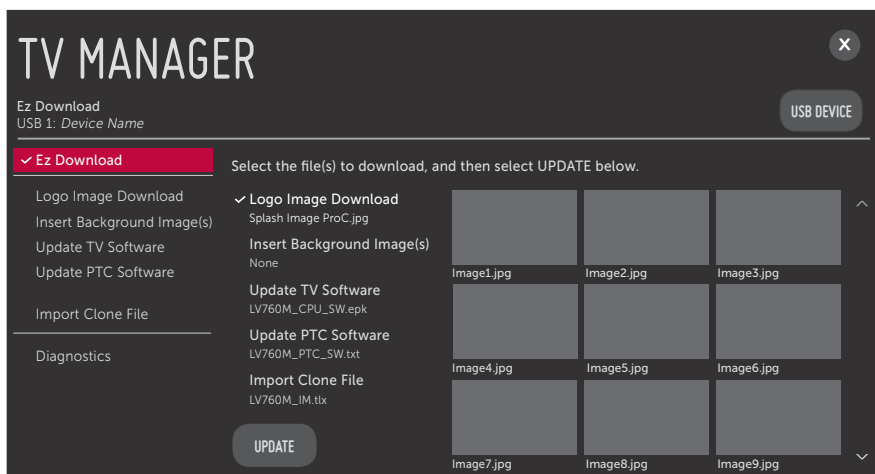

(Continued on next page)

Reference: Updating TV/PTC Software using a USB Memory Device (Cont.)

(Continued from previous page)

Note: Ez Download is always selected by default when you initially access the TV Manager. Also note that Diagnostics is for service use only.

5. Use the Up/Down arrow keys to select **Update TV Software** or **Update PTC Software**, as applicable, and press **OK**.

Depending on your selection, a list of either TV or PTC software files stored in the LG_DTV folder on the USB memory device will be displayed on the screen. Above the listing of files, you can also see the current version of TV or PTC software. The following screen sample illustrates an Update TV Software screen.

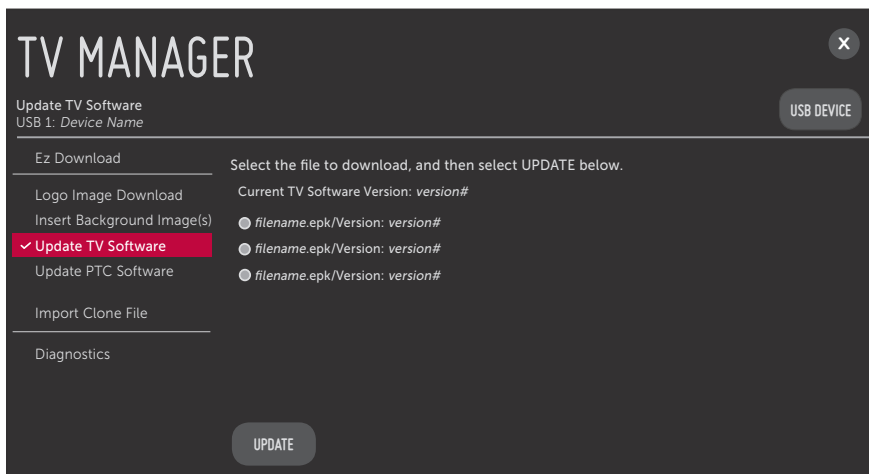

6. Use the arrow keys to select/highlight the update file to download, and then press **OK**.
7. When you are ready to download the update, select **UPDATE** on the screen, and then press **OK** on the Installer Remote.

Software update progress will be displayed on the screen. Do NOT remove the USB device until the software update is complete. When the software update is complete, an UPDATE COMPLETE pop-up banner will briefly be displayed at the bottom of the screen, and then, the TV will reboot.

Reference: Downloading a Splash Screen Image using a USB Memory Device

This section describes how to download a splash screen image using the TV Manager “Logo Image Download” option, though you may also use the Ez Download utility to download the splash screen image, if desired. See “Ez Download Utility” on pages 39 to 42 for further information.

Splash Screen Image File Guidelines

- The splash screen image may be either a baseline or progressive JPEG or a 24-bit (RGB 8x8x8) BMP.
- A JPEG image should be no larger than 6 MB.
- A BMP image should be no larger than 5.93 MB.
- The maximum resolution allowed for a 24/28LV760M splash screen image is 1360 x 768 pixels (HD).
- The maximum resolution allowed for a 32LV760M splash screen image is 1920 x 1080 pixels (FHD).
- Avoid using special characters, such as ?, &, @, etc., in the splash screen image filename.

Before You Begin

- The splash screen image file must be stored in a folder named “LG_DTV” in the root directory of the USB memory device.
- Ensure the USB device has been formatted with FAT format.

Download the Splash Screen Image

1. Turn ON the TV, and then insert the USB memory device into the TV's USB port.
2. Press **MENU** on the Installer Remote to display the TV setup menus (TV is in Pass-through Mode) or the Function Menu (TV is not in Pass-through Mode).
3. (TV in Pass-through Mode only) From the Quick Settings Menu displayed at the right of the screen, select the **All Settings**  menu icon and press **OK** to access the advanced TV setup menus.
4. Use the arrow navigation keys to select/highlight either the **General** menu icon from the TV setup menus or the **Safety** menu icon from the Function Menu. Then, press the number “7” key a total of seven times to access the TV Manager (see example on following page).

Note: Ez Download is always selected by default when you initially access the TV Manager. Also note that Diagnostics is for service use only.

(Continued on next page)

Reference: Downloading a Splash Screen Image using a USB Memory Device (Cont.)

(Continued from previous page)

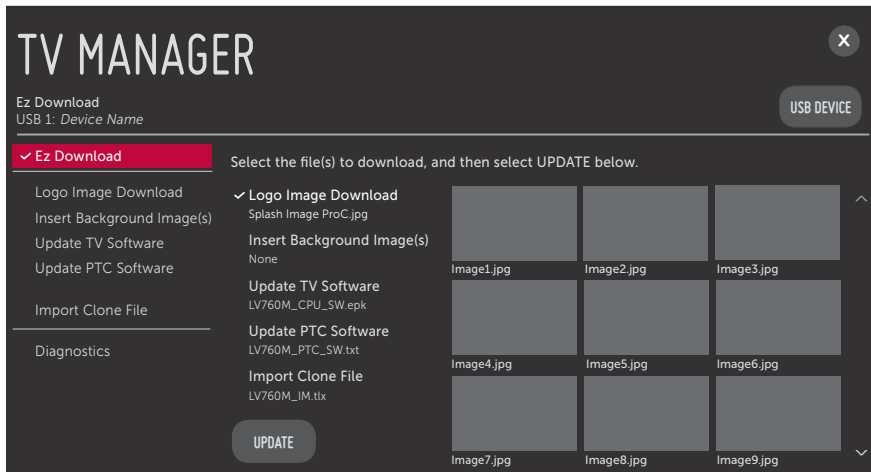

5. Use the Up/Down arrow keys to select **Logo Image Download**, and then press **OK**.

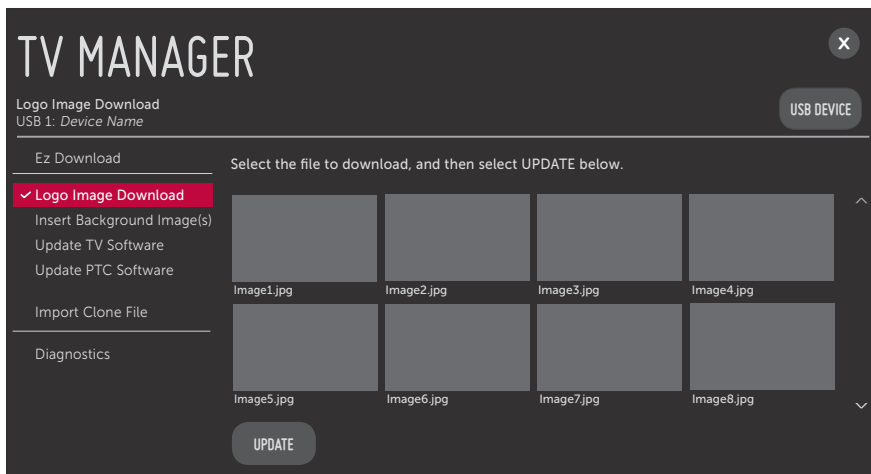

6. Use the arrow keys to select/highlight the image file to download, and then press **OK**.

7. When you are ready to download the image file, select **UPDATE** on the screen, and then press **OK** on the Installer Remote.

Logo image update progress will be displayed on the screen. Do NOT remove the USB device until the splash screen image update is complete. When the image update is complete, a **DOWNLOAD COMPLETE** pop-up banner will briefly be displayed at the bottom of the screen, and then, the TV will reboot. During the reboot, you should see the new splash screen.

Reference: Downloading Background Images using a USB Memory Device

Background images are intended for use with audio-only channels and the Bluetooth Sound Sync feature. Guests may choose to display a slideshow on the screen (as opposed to a blank screen or the Bluetooth Sound Sync screen) while audio is playing.

This section describes how to download background images using the TV Manager “Insert Background Image(s)” option, though you may also use the Ez Download utility to download the background image(s), if desired. See “Ez Download Utility” on pages 39 to 42 for further information.

Background Image File Guidelines

- A background image may be either a baseline or progressive JPEG or a 24-bit (RGB 8x8x8) BMP.
- A JPEG image should be no larger than 6 MB.
- A BMP image should be no larger than 5.93 MB.
- The maximum resolution allowed for a 24/28LV760M background image is 1360 x 768 pixels (HD).
- The maximum resolution allowed for a 32LV760M background image is 1920 x 1080 pixels (FHD).
- Avoid using special characters, such as ?, &, @, etc., in a background image filename.

Before You Begin

- The background image file(s) must be stored in a folder named “LG_DTV” in the root directory of the USB memory device.
- Ensure the USB device has been formatted with FAT format.

Download the Background Image(s)

1. Turn ON the TV, and then insert the USB memory device into the TV's USB port.
2. Press **MENU** on the Installer Remote to display the TV setup menus (TV is in Pass-through Mode) or the Function Menu (TV is not in Pass-through Mode).
3. (TV in Pass-through Mode only) From the Quick Settings Menu displayed at the right of the screen, select the **All Settings**  menu icon and press **OK** to access the advanced TV setup menus.
4. Use the arrow navigation keys to select/highlight either the **General** menu icon from the TV setup menus or the **Safety** menu icon from the Function Menu. Then, press the number “7” key a total of seven times to access the TV Manager (see example on following page).

Note: Ez Download is always selected by default when you initially access the TV Manager. Also note that Diagnostics is for service use only.

(Continued on next page)

Reference: Downloading Background Images using a USB Memory Device (Cont.)

(Continued from previous page)

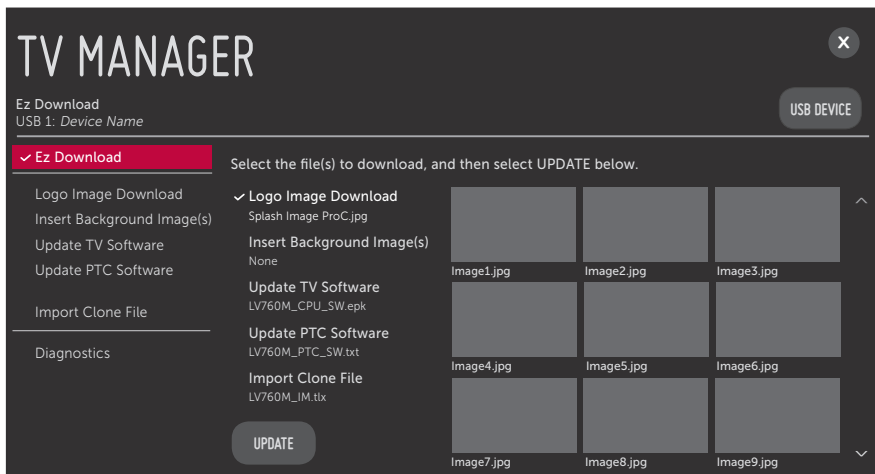

5. Use the Up/Down arrow keys to select **Insert Background Image(s)**, and then press **OK**.

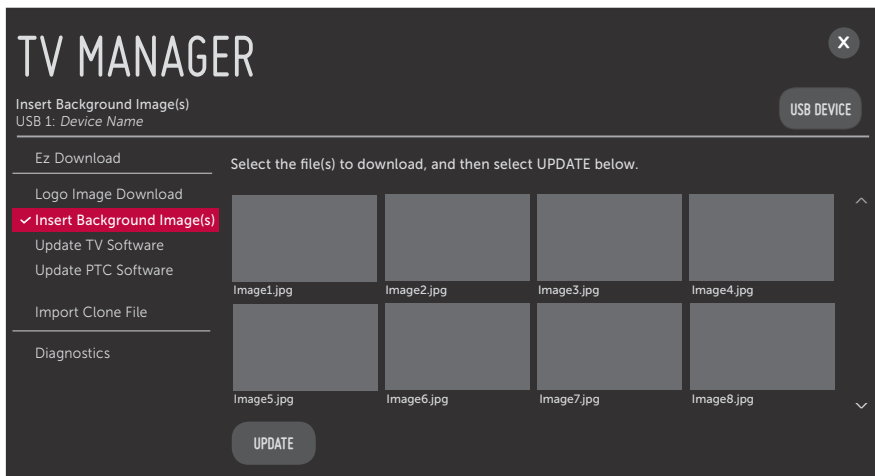

6. Use the arrow keys to select/highlight the image file(s)—up to 12 images or 10 MB—to download, and then press **OK**.

7. When you are ready to download the image file(s), select **UPDATE** on the screen, and then press **OK** on the Installer Remote.

Background image update progress will be displayed on the screen. Do NOT remove the USB device until the background image update is complete. When the image update is complete, a **DOWNLOAD COMPLETE** pop-up banner will briefly be displayed at the bottom of the screen, and then, the TV will reboot.

Reference: Power Consumption Settings

The following tables assume that Installer Menu item 099 BACK LIGHTING is set as shown below (default value is 255).

Item 099 Back Lighting (Static)	24LV760M		28LV760M		32LV760M	
	Power Consumption (Watts)	Percent Savings	Power Consumption (Watts)	Percent Savings	Power Consumption (Watts)	Percent Savings
100	24.4	0%	25.9	0%	38.5	0%
90	23.5	4%	25.0	3%	36.3	6%
80	22.7	7%	23.9	8%	34.3	11%
70	21.6	11%	23.0	11%	32.1	17%
60	20.8	15%	22.1	15%	29.6	23%
50	19.8	19%	21.0	19%	27.6	28%
40	18.7	23%	20.1	22%	25.5	34%
30	17.8	27%	19.2	26%	23.2	40%
20	17.0	30%	18.1	30%	21.2	45%
10	16.0	34%	17.2	34%	18.9	51%
1	15.1	38%	16.3	37%	16.8	56%

Item 099 Back Lighting (Dynamic)	24LV760M		28LV760M		32LV760M	
	Power Consumption (Watts)	Percent Savings	Power Consumption (Watts)	Percent Savings	Power Consumption (Watts)	Percent Savings
200	24.4	0%	25.9	0%	38.6	0%
190	23.5	4%	25.0	3%	36.5	5%
180	22.7	7%	23.9	8%	34.4	11%
170	21.6	11%	23.1	11%	32.2	17%
160	20.8	15%	22.1	15%	29.8	23%
150	19.8	19%	21.0	19%	29.8	23%
140	18.8	23%	20.2	22%	25.5	34%
130	17.8	27%	19.2	26%	23.3	40%
120	17.0	30%	18.1	30%	21.2	45%
110	16.0	34%	17.1	34%	18.9	51%
101	15.0	39%	16.3	37%	16.9	56%

Note: Values are results of controlled experiments under laboratory conditions.

Reference: TV Aux Input Configuration

DIRECT ACCESS Tuning *		TV		ENABLE					MPI DATA				Installer Menu Item 046 START AUX SRCE (Start Aux Source) Value
				Installer Menu			MPI DATA STATUS TYPE 0x41 SOURCES ENABLED (R/W)	DATA STATUS TYPE 0xD2 CURRENT AV SOURCE (R)	DATA STATUS TYPE 0x0D AUX SOURCE (R)				
Installer Menu Item 029 REMAP AUX INPS = 0	Installer Menu Item 029 REMAP AUX INPS = 1	Aux Input	Input Mode	Item	Function	Value	Enable Bit	Label	Value	Value	Description		
132-0	92-0	HDMI 2	DTV	91	HDMI2 ENABLE	1	2	S-Video Rear	2	0	VIDEO	5	
			PC			2				2	COMPUTER		
133-0	93-0	HDMI 1	DTV	35	HDMI1 ENABLE	1	3	Front Computer	3	0	VIDEO	3	
			PC			2				2	COMPUTER		

* Use Installer Remote to enter channel number indicated based on REMAP AUX INPS Installer Menu setting.

Reference: Auto Input(s) Sensing Feature

This section provides detailed settings information for Installer Menu item 042 AUTO INPUTS. To disable auto-sensing for all available Aux inputs, set item 042 to 0. To enable auto-sensing for all available Aux inputs, set item 042 to 255. For specifications on all other available settings (i.e., settings for individual inputs), refer to the Aux Inputs Values table on the following page.

Note: When both item 042 AUTO INPUTS *and* item 041 SIMPLINK EN are enabled in the Installer Menu, HDMI inputs will be detected by SIMPLINK, but the Auto Input(s) Sensing Feature will not function.

In the Installer Menu, an informational text code is displayed at the right of each Auto Inputs value, for example:

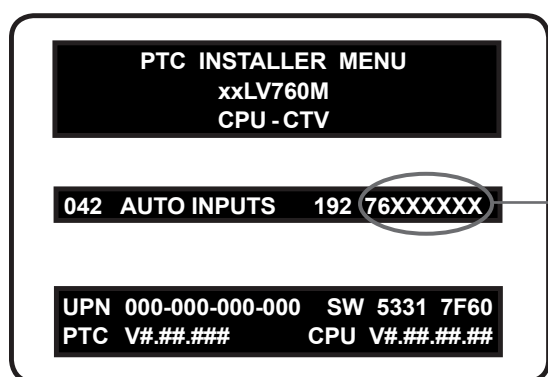

AUTO INPUTS Text Code

This example illustrates Installer Menu item 042 value 192, which enables auto-sensing for all available Aux inputs. The input #s in the text code (7 & 6 in this example) identify the enabled Aux inputs. See the Input # Assignments table below for a listing of the LV760M Aux inputs and their corresponding text code input #s. The Auto Inputs Values table on the following page shows the text codes for all item 042 values.

Each Auto Inputs text code consists of eight characters that identify the Aux input(s) for which auto-sensing is enabled. The following table identifies the Installer Menu text code input # for each Aux input that is available on the LV760M TV models. The table also identifies the Installer Menu item associated with each Aux input. Remember that in order for auto-sensing to be enabled for an input, that input must also be enabled in the Installer Menu.

Input # Assignments

Installer Menu Text Code Input #	Aux Input	Installer Menu	
		Item	Function
6	HDMI 1	035	HDMI1 ENABLE
7	HDMI 2	091	HDMI2 ENABLE

Reference: Auto Input(s) Sensing Feature (Cont.)

The following table shows all available Aux inputs as if each is enabled in the Installer Menu. The Installer Menu text codes for item 042 will be altered accordingly if any of the available Aux inputs are disabled in the Installer Menu.

Auto Inputs Values

Item 042 Value	Aux Inputs		Installer Menu Display
	HDMI 1	HDMI 2	
000	Disabled	Disabled	DDXXXXXX
064	Enabled	Disabled	D6XXXXXX
128	Disabled	Enabled	7DXXXXXX
192	Enabled	Enabled	76XXXXXX
255	Enabled	Enabled	76XXXXXX

X = Aux input is Disabled or Not Available (i.e., on these TV models)

D = Auto-sensing for input is Disabled

Input # = Auto-sensing for input is Enabled

Reference: LV760M Hospital Operations

Hospital Features

The following table identifies when and how the LV760M hospital features are supported in three different TV configurations. As indicated in the introduction to this document, LG commercial TV functionality is based on “ownership” of the Channel Map. For the purposes of this table, “CPU” indicates that the TV is in Pass-through Mode with the Channel Map in the CPU (i.e., auto-tuned/edited channel lineup) and “PTC” indicates that the TV is in Pass-through Mode with the Channel Map in the PTC (PTC-CTV Mode).

Hospital Mode State	Item	CPU		PTC		FTG/PPV Mode	
		Disabled	Enabled	Disabled	Enabled	Disabled	Enabled
Installer Menu	Item						
IR Banks Enable	012				X		
Scan Mode	013			X	X	X*	X*
Start Channel in Scan Mode	014			X	X	X*	X*
Feature Level	020						
Bed 1/Bed 2	020	X		X		X	
Multi-code IR	020	X	X	X	X	X	X
Speaker	020	X		X		X	
Function Preview	025			X	X		
Hospital Mode	027						
Bed 1/Bed 2	027		X		X		X
Pillow Speaker Voltage	027	(b)	X	(b)	X	(b)	X
Speaker	027		X		X		X
Quick Shutoff	077	(c)	(c)	(c)	(c)	(c)	(c)
Channel Banks							
Number of Banks Enabled				1	4	1	4*
Channel Preview/Banks Setup Menu				X	X		
Blanked Channel				X	X	X	X
Inactive TV					X		X*
SAP Key (special use in Channel Preview/Banks Setup Menu)					X		
Aux Input Sources							
Input List Menu		X	X	X		X	
Aux in Channel Lineup				X	X	(d)	X*/(d)
TV Setup Menus							
Sound Out (TV Speaker)		(e)	(e)	(e)	(e)	(e)	(e)
General (Standby Light)		X	X	X	X		

* Applicable for FTG Mode via CPU only.

X = feature supported

a) Turn ON function only. Always goes to channel 2-0.

b) Zenith pillow speaker code/(+12v) supply voltage. (When Installer Menu item 027 is set to 254 [factory default value], there is no power [voltage] supplied to the pillow speaker interface.)

c) Quick Shutoff feature only functions when Scan Mode is enabled and if you are using an analog pillow speaker.

d) Dependent upon installer-defined FTG/PPV Channel Map.

e) Sound Out Menu is only accessible when the speaker selected is TV Only or both TV & Pillow.

Reference: LV760M Hospital Operations (Cont.)

Speaker Selection

The following table identifies the speaker sound source as determined by Installer Menu items 027 HOSPITAL MODE and 020 FEATURE LEVEL and the Sound Out Menu setting.

Item 027 HOSPITAL MODE Value	Item 020 FEATURE LEVEL Value	Sound Out Menu Setting	Sound Source
0	0–24	TV Speaker	TV (Internal) Speaker
0	0–24	External Speaker	External Speaker *
0	64–65	N/A	Pillow Speaker
1–34	N/A	N/A	Pillow Speaker
65–98	N/A	TV Speaker	TV (Internal) Speaker
65–98	N/A	External Speaker	External Speaker *
129–162	N/A	TV Speaker	Pillow Speaker and TV (Internal) Speaker
129–162	N/A	External Speaker	Pillow Speaker and External Speaker

* You will only hear sound if an external speaker is connected to the TV.

Note: The Sound Out Menu is only accessible when the speaker selected is TV Only or both TV & Pillow.

Reference: Restoring Factory Defaults on the TV(s)

This section describes how to restore all factory defaults or just the Installer Menu factory defaults either on a single TV that is currently in Pass-through Mode, FTG Mode, Application Tuning Mode, etc. or on multiple TVs that are currently in FTG Mode.

Restore All Factory Defaults

This section describes how to restore a single TV, regardless of its mode, to a factory default condition. The following procedure requires that you contact LG technical support to obtain a predefined value/ password for Installer Menu item 117 FACT DEFAULT that enables access to initiate a factory “IN-STOP” process, which restores all factory defaults. This procedure will also reactivate the LG First Use Wizard.

1. Use the Installer Remote to access the TV’s Installer Menu.
2. Navigate to Installer Menu item 117 FACT DEFAULT, and key in the value provided by technical support. Then, press **OK**.
3. At the prompt for confirmation, key in the password provided by technical support. This will initiate the IN-STOP that restores the factory defaults on the TV.

Installer Menu Item 117 FACT DEFAULT

If the TV is currently in Pass-through Mode, you can set Installer Menu item 117 FACT DEFAULT to 1 to restore the Installer Menu factory defaults and clear the PTC Channel Map, including any assigned channel icons and custom text labels. Note, however, that if a complete restoration of the TV’s factory defaults is required, see “Restore All Factory Defaults” above.

Additional FTG Mode Options

There are two additional options for restoring Pass-through Mode/Installer Menu factory defaults on TVs that are in FTG Mode via the CPU. The first enables you to restore a single TV to Pass-through Mode, while the second enables you to restore multiple TVs to Pass-through Mode at one time. However, both options require that you create a “Restore_Pass-through_Mode.tlx” file, i.e., an FTG Configuration file with no data. Refer to the **Cloud Configuration Tool User Guide** for further information.

- Using a USB memory device, import a “Restore_Pass-through_Mode.tlx” file to the TV. Refer to “Importing a Clone File” on pages 59 to 62 for further information on the import procedure.
- If your system uses a Pro:Centric server for remote management of LV760M TVs that are in FTG Mode, use the Pro:Centric Admin Client to load a “Restore_Pass-through_Mode.tlx” file on the Pro:Centric server. Refer to the **Pro:Centric Server Admin Client User Guide** for further information.

Reference: Using the TV's Zoning Features

This section describes the TV Zoning and Wi-Fi Zoning features available with the LV760M model TVs. These features are primarily intended for use when the TV is configured for FTG Mode via CPU operation; however, Wi-Fi Zoning, along with selected elements of TV Zoning (Installer Menu and Setup Menu profile Zone assignments), may also be used with TV cloning processes using a Clone (.tlx) file. Refer to the appropriate section(s) below for further information on the Zoning features and how to set the TV Zone # and/or Wi-Fi Zone # in a TV that is currently in Pass-through Mode.

TV Zoning Feature

The TV Zoning feature enables you to create localized configurations for TVs in selected “Zones” within the installation site, for example, a lobby area, fitness center, restaurant, etc.

Using the TV Zoning Feature with FTG Mode via CPU Configuration

The Cloud Configuration Tool may be used to create an FTG Configuration (.tlx) file that contains multiple Installer Menu and Setup Menu profiles, each with its own Zone assignment. Up to nine unique Zones can be designated for LV760M FTG Installer Menu and/or Setup Menu profiles. Zone restrictions can also be placed on individual channels in the FTG Channel Map. Thus, for example, you may create an FTG Installer Menu and/or Setup Menu profile to uniquely configure a TV in the fitness center and also restrict the channels that are available to be tuned on that TV.

The TV Zone # must be set appropriately on each TV in order for the TVs to be configured correctly. See “Set the TV Zone # and/or Wi-Fi Zone # in the TV” on page 95, and set the TV Zone # in all the TVs in a select area, so that the TVs are configured with corresponding FTG Installer Menu and/or Setup Menu settings and/or can omit channels that have been restricted in the FTG Channel Map. TV Zone 0 is the default TV Zone #.

The following subsections briefly describe how to assign Zones in the Cloud Configuration Tool. Refer to the **Cloud Configuration Tool User Guide** for further information.

FTG Installer Menu Profile Zone Assignments

The Cloud Configuration Tool / Installer Menu web page enables you to create multiple Installer Menu profiles for the same chassis model, each with a different Zone assignment (default = Zone 0), to be included in an FTG Configuration (.tlx) file. For example, you may wish to create one Installer Menu profile for the LV760M TV in the lobby area and another Installer Menu profile for the LV760M TV in the fitness center, both of which are different from the Installer Menu profile used for LV760M TVs in standard patient rooms. The TV Zoning feature enables you to save multiple LV760M FTG Installer Menu profiles, each with its own Zone assignment, in one FTG Configuration file. If each TV in the aforementioned locations (Zones) has had its TV Zone # set appropriately, as described in the procedure on page 95 or via the EZ-Manager Wizard, the TV(s) will only be configured by the Installer Menu profile that matches its(their) Zone setting.

In the Cloud Configuration Tool / File Manager web page, you can also change the Zone assignment for each Setup Menu profile already present in the FTG Configuration List. See the File Manager and Installer Menu web page overviews on pages 66 and 69 for further information. Note that Setup Menu profiles cannot be created in the Cloud Configuration Tool; they must be saved (exported) from a TV.

FTG Channel Map Zone Restrictions

In the Cloud Configuration Tool / Channel Map screen, you can place Zone restrictions on individual channels that may be prohibited or deemed unsuitable for certain locations. One or more Zone restrictions (1–8) may be placed on each channel that is to be restricted. For example, if you wish to restrict a channel from Zones 2 and 4, select both “Zone 2” and “Zone 4” in the Restricted from Zones field when defining or editing that channel.

Reference: Using the TV's Zoning Features (Cont.)

Note: While a channel can be restricted from up to eight Zones, a TV can only ever be in (set for) one Zone. See also the Channel Map web page overview on page 67.

At the same time, keep in mind that the TV Zone designations are not mutually exclusive. That is, you may opt to place Zone restrictions on selected channels in the FTG Channel Map, but at the same time, you can choose to configure all TVs at the site with the same Installer Menu and/or Setup Menu settings. For example, an FTG Configuration (.tlx) file being used to configure the TVs at a site may contain multiple Installer Menu and Setup Menu profiles with different Zone assignments, as well as an FTG Channel Map with Zone restrictions on several channels. Each TV that still has the default TV Zone 0 setting will *only* be configured by the Installer Menu and/or Setup Menu profile(s) with a Zone 0 designation. If, on the other hand, the TV Zone # is set to 1, the TV will first look in the file for the LV760M Installer Menu and/or Setup Menu profile(s) with a Zone 1 designation. If none of the LV760M Installer Menu and/or Setup Menu profiles has a Zone 1 designation, the TV will then look for the LV760M profile(s) with a Zone 0 designation. For the FTG Channel Map configuration, when the TV Zone # is set to 0, the TV will ignore any Zone restrictions (1–8) that may be placed on channels in the FTG Channel Map. However, when the TV Zone # is set to 1, the TV will omit any channels that have been restricted from Zone 1 in the FTG Channel Map.

Using the TV Zoning Feature with Cloning Configuration

A location-specific configuration / Clone (.tlx) file may be saved (exported) from a Master TV and then be used to configure Target TVs. For example, if the TV Zone # in the Master TV is set to 3 before the Clone file export is initiated, the Master TV's Installer Menu and Setup Menu profiles will be saved with the TV Zone 3 assignment. In order to configure the Target TVs with the Zone 3 Installer Menu and Setup Menu profiles exported from the Master TV, you must set the TV Zone # accordingly in the Target TVs before importing the Clone file. See "Set the TV Zone # and/or Wi-Fi Zone # in the TV" on the following page. Also, see "Cloning Procedures" on pages 57 to 62 for additional information on the cloning processes. TV Zone 0 is the default TV Zone #.

Wi-Fi Zoning Feature

The Wi-Fi Zoning feature enables you to use a Clone/Configuration (.tlx) file to configure an individual TV or group of TVs with a particular Wi-Fi access point's login data to create "Wi-Fi Zones" within the installation environment.

Using the Wi-Fi Zoning Feature with FTG Mode via CPU Configuration

The Cloud Configuration Tool may be used to create an FTG Configuration (.tlx) file with an FTG Installer Menu profile that contains login data for multiple Wi-Fi access points, each assigned a Wi-Fi Zone #. Up to 100 Wi-Fi Zones can be designated within each FTG Installer Menu profile, thus allowing for distribution of the Wi-Fi network load. For example, if a site has 50 LV760M TVs within close proximity, you may wish to create 10 Wi-Fi Zones, each with its own access point that has unique login data, so that no more than five of the TVs are connected to one access point at any given time.

In order for a TV to be configured by the proper Installer Menu profile with the desired Wi-Fi access point login data for wireless networking (i.e., SSID, security type, and security key), you must set both the TV Zone # and the Wi-Fi Zone # in the TV (see "Set the TV Zone # and/or Wi-Fi Zone # in the TV" on the following page for further information). If the Wi-Fi Zone # in the TV is set to 0 (default), the TV will not obtain access point login data from the Installer Menu profile with which it is configured unless the profile contains the global Wi-Fi Zone 100. Any TV that does not find its matching Wi-Fi Zone # in the FTG Configuration file, but does find the global Wi-Fi Zone 100, will be configured with the global access point login data.

Refer to the **Cloud Configuration Tool User Guide** for further information on defining Wi-Fi Zones in the Cloud Configuration Tool.

Reference: Using the TV's Zoning Features (Cont.)

Using the Wi-Fi Zoning Feature with Cloning Configuration

A location-specific Wi-Fi configuration / Clone (.tlx) file may be saved (exported) from a Master TV and then be used to configure Target TVs. First, the wireless network (i.e., the access point login data) must be configured in the Master TV's IP Environment Menu (see "Configuring a Wi-Fi Network Connection" on page 72). Then, a Wi-Fi Zone # must be set in the Master TV (see "Set the TV Zone # and/or Wi-Fi Zone # in the TV" below). If desired, a TV Zone # may also be set in the Master TV.

For example, if the Wi-Fi Zone # is set to 4 and the TV Zone # is set to 5 before the Clone file export is initiated, the Master TV's Installer Menu profile will be saved with the Zone 5 assignment, and within that Installer Menu profile, the access point login data for wireless networking (i.e., SSID, security type, and security key) will be saved with a Wi-Fi Zone 4 assignment. In order to configure the Target TVs with the proper Installer Menu profile and access point login data, you must set both the TV Zone # and the Wi-Fi Zone # in the Target TVs accordingly before importing the Clone file. See "Set the TV Zone # and/or Wi-Fi Zone # in the TV" below. Also, see "Cloning Procedures" on pages 57 to 62 for additional information on the cloning processes. If the Wi-Fi Zone # in the TV is set to 0 (default), the TV will not obtain access point login data from the Installer Menu profile with which it is configured unless the profile contains the global Wi-Fi Zone 100. Any TV that does not find its matching Wi-Fi Zone # in the Clone file, but does find the global Wi-Fi Zone 100, will be configured with the global access point login data.

Set the TV Zone # and/or Wi-Fi Zone # in the TV

You can set the TV Zone # and/or the Wi-Fi Zone # in the EZ-Manager Wizard (see "EZ-Manager Wizard" on pages 19 to 27) or, if the TV is in Pass-through Mode, via the TV's setup menus as described below. Note that the following procedure can only be performed while the TV is in Pass-through Mode. You will also be able to specify a Label (North, South, East, West) and Room Number for this TV, if desired.

1. Turn ON the TV.
2. Press **MENU** on the Installer Remote, and use the arrow navigation keys to select/highlight the **General** menu icon. Then, press **OK**.
3. In the General Menu, use the Up/Down arrow keys to select **Room Info**, and then press **OK**.
4. In the Room Info screen, complete the appropriate fields as described below. Use the Up/Down arrow keys on the Installer Remote to navigate between each of the fields.
 - **Wi-Fi Zone:** Enables you to set a Wi-Fi Zone # so that the TV can be configured with a particular access point's login data for wireless networking. Login data (i.e., SSID, security type, and security key) may be provided in a Clone/Configuration (.tlx) file.
To assign a Wi-Fi Zone, select/highlight the **Wi-Fi Zone** field and press **OK**. Then, use the Left/Right arrow keys to specify the desired Wi-Fi Zone # (1–99). Press **OK** when you are finished.
 - **TV Zone:** Enables you to set a TV Zone # so that the TV can be configured with Installer Menu and/or Setup Menu settings intended only for the assigned Zone. The Installer Menu and/or Setup Menu settings may be provided in a Clone/Configuration (.tlx) file. If the TV is being configured for FTG Mode via CPU, the TV Zone # setting also allows the TV to omit channels that have been restricted in the FTG Channel Map (see "FTG Channel Map Zone Restrictions" on page 93).
To change the TV Zone, select/highlight the **TV Zone** field and press **OK**. Then, use the Left/Right arrow keys to specify the desired TV Zone # (0–8). Press **OK** when you are finished.

(Continued on next page)

Reference: Using the TV's Zoning Features (Cont.)

(Continued from previous page)

- **Label:** Allows you to select a North, South, East, or West text label for this TV. Select/highlight the **Label** field and press **OK**. Then, use the Up/Down arrow keys to select the applicable label. Press **OK** when you are finished.
- **Room Number:** Allows you to specify the number of the room in which the TV is located. To enter a room number, use the Up/Down arrow keys to select/highlight the **Room Number** field and press **OK**. You can then use the number keys on the Installer Remote to directly enter a room number, or you can use the arrow keys to select the appropriate alphanumeric character(s) from the pop-up virtual keyboard at the bottom of the screen. When you are done, select **Enter** from the virtual keyboard, and then press **OK** on the Installer Remote.

Note: The TV name (default: TV's serial number) will be changed to the room number specified here. See "Media Share Setup" on pages 77 to 78 for further information on the TV name.

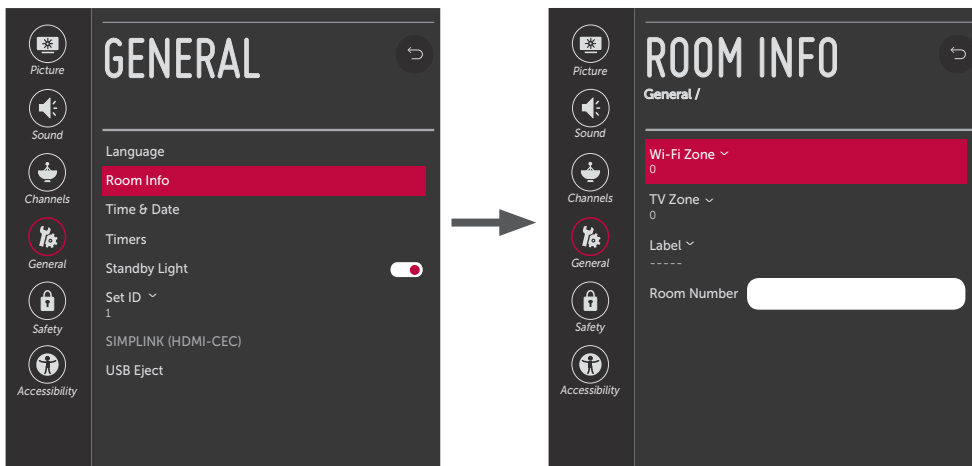

5. When you have completed the fields as necessary, press **↵** to return to and/or exit the TV menus, or press **MENU** to return to program viewing.

Reference: Using Media Share Features

When the appropriate Media Share options are enabled in the IP Environment / Media Share Menu (see “Media Share Setup” on pages 77 to 78, as necessary), guests have the ability to use one or more of the following Media Share features:

- **Smart Share:** Allows guests to use the TV to access and view media files (photos, videos, music, etc.) shared either by wired DLNA Certified devices (the devices must be connected to the same LAN as the TV) or by wireless LG devices using LG’s Smart Share application with Wi-Fi Direct.
- **Screen Share:** Allows guests to select a Miracast or WiDi capable device, whose screen can be displayed on the TV.
- **DIAL:** Allows guests to play selected application media on the TV from a device with DIAL capability. The device may be used to cast any application for which a TV-compatible application has been created/ selected for inclusion in the Pre-loaded Apps Menu (see “Pre-loaded Applications” on page 79).
- **SoftAP:** Allows guests to use the TV as a 2.4 GHz wireless access point for up to five devices.

This section provides an overview of the Smart Share, Screen Share, DIAL, and SoftAP functionality.



Note: Typically, only one Media Share feature may be used at a time. If one feature is currently in use, you may have to exit or turn it OFF in order to use/turn ON another. In some cases, you will be prompted to confirm your action. Follow the display prompts as necessary.

Smart Share

Refer to the subsections below for information on using the Smart Share features.

Smart Share with DLNA Certified Devices

The following steps describe how to access and use the Smart Share feature with wired DLNA Certified devices on the same LAN as the TV.

1. Turn ON the TV, and then use one of the following methods to access media files/folders, depending on the current configuration of the TV:
 - If the Pro:Centric application is not loaded, press **PORTAL** on the Installer Remote, and use the Left/Right arrow keys to select **Music** or **Photo & Video** from the TV’s Smart Launcher.
 - If the Pro:Centric application is loaded, press **MENU** on the Installer Remote to display the Function Menu, use the Up/Down arrow keys to select/highlight the **General** menu icon, and then press **OK**. In the General Menu, use the Up/Down arrow keys to select **Music** or **Photo & Video**.

Note: Depending on the remote control being used (in any mode), you may also access the Smart Launcher via the SMART key.

2. In the next screen (Music or Photo & Video, depending on your selection in the previous step), select the desired Smart Share device, and then select the desired file(s) to view.

Smart Share with Wi-Fi Direct

The following steps describe how to access and use Wi-Fi Direct (i.e., to connect to a wireless LG device). Remember that you must also turn ON Wi-Fi Direct and launch the Smart Share application on the LG device.

Note: Screen Share MUST be enabled in the Media Share Menu in addition to Smart Share in order for guests to use Wi-Fi Direct (see “Media Share Setup” on pages 77 to 78).

(Continued on next page)

Reference: Using Media Share Features (Cont.)

(Continued from previous page)

1. Turn ON the TV, and press **MENU** on the Installer Remote to display the TV menus (either the setup menus or the Function Menu depending on whether the TV is or is not in Pass-through Mode).
2. Use the Up/Down arrow keys to select/highlight the **General** menu icon, and then press **OK**.
3. In the General Menu, use the Up/Down arrow keys to select **Wi-Fi Direct**, and then press **OK**.

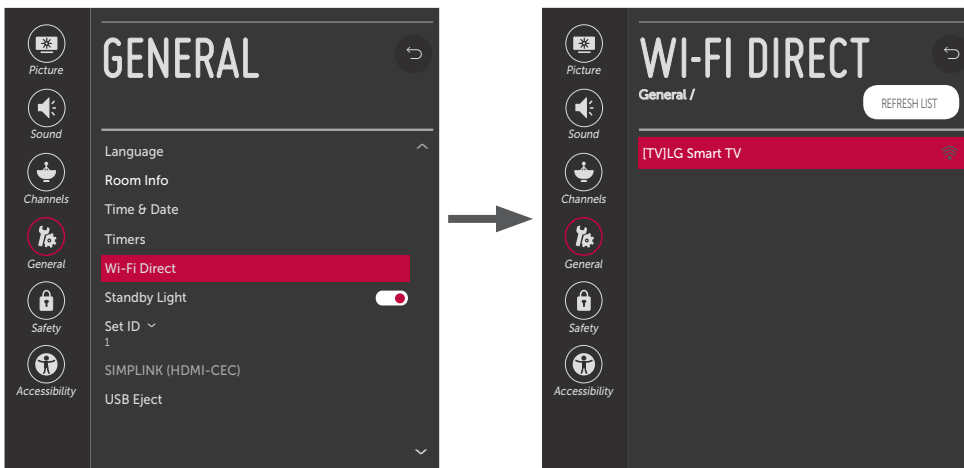

Note: The example at left shows the General Menu when the TV is in Pass-through Mode. The Wi-Fi Direct screen is the same whether the TV is or is not in Pass-through Mode.

Note: If Wi-Fi Direct is currently grayed out, you may need to exit/turn OFF another Media Share feature in order to use Wi-Fi Direct. For example, make sure that SoftAP is turned OFF. See also note on previous page regarding simultaneous use of Media Share features.

4. When you access the Wi-Fi Direct screen, the TV will automatically initiate a search for all available Wi-Fi Direct enabled wireless devices, including mobile devices, laptops, etc. Devices found will be listed in the lower half of the screen.

Note: If the search does not initially locate any devices, you can select **REFRESH LIST** and press **OK** to rescan.

5. Use the Up/Down arrow keys to select/highlight the device with which you wish to share, and then press **OK**.

The share request will be sent to the targeted device. The user of that device may choose to allow or not allow the share connection. Similarly, other devices may request share connections with this TV (pop-up share requests typically appear in the bottom of the TV screen).

6. Use one of the following methods to access media files/folders, depending on the current configuration of the TV:

- If the Pro:Centric application is not loaded, press **PORTAL** on the Installer Remote, and use the Left/Right arrow keys to select **Music** or **Photo & Video** from the TV's Smart Launcher.
- If the Pro:Centric application is loaded, use the Up/Down arrow keys to select **Music** or **Photo & Video** from the General Menu.

Note: Depending on the remote control being used (in any mode), you may also access the Smart Launcher via the SMART key.

7. In the next screen (Music or Photo & Video, depending on your selection in the previous step), select the desired Smart Share device, and then select the desired file(s) to view.

Screen Share (Miracast / WiDi)

The following steps describe how to access and use the Miracast / WiDi features.

1. Turn ON the TV, and then use one of the following methods to access the Screen Share application, depending on the current configuration of the TV:
 - If the Pro:Centric application is not loaded, press **PORTAL** on the Installer Remote, and use the Left/Right arrow keys to select **Screen Share** from the TV's Smart Launcher.
 - If the Pro:Centric application is loaded, press **MENU** on the Installer Remote to display the Function Menu, use the Up/Down arrow keys to select/highlight the **General** menu icon, and then press **OK**. In the General Menu, use the Up/Down arrow keys to select **Screen Share**.

Note: Depending on the remote control being used (in any mode), you may also access the Smart Launcher via the SMART key.

Note: If Screen Share is currently not available in the Smart Launcher or in the General Menu (the latter applicable to FTG Mode only), you may need to turn OFF another Media Share feature in order to use Screen Share. For example, access the General Menu and make sure that SoftAP is turned OFF. See also note on page 97 regarding simultaneous use of Media Share features.

2. Follow the on-screen instructions to initiate the Miracast / WiDi connection from your Miracast / WiDi device. Note that you may be prompted to enter a PIN number that appears on the TV screen into your Miracast / WiDi connection window to complete the connection.

Once the connection is established, the TV display may be used as a second screen for the Miracast / WiDi device.

DIAL

The following steps describe how to access and use DIAL. Remember that the device used MUST be connected to the same network as the TV.

Note: DIAL may only be used with device applications for which a TV-compatible application (for example, YouTube) has been created/selected for inclusion in the Pre-loaded Apps Menu (see "Pre-loaded Applications" on page 79).

Note: The applications that may be used in conjunction with DIAL are only accessible from the TV's Smart Launcher. If the TV is not in Pass-through Mode, you will need a remote with a SMART key in order to display the Smart Launcher.

1. Turn ON the TV, and then use one of the following methods to display the TV's Smart Launcher, depending on the current configuration of the TV:
 - If the Pro:Centric application is not loaded, press **PORTAL** on the Installer Remote.
 - If the Pro:Centric application is loaded, press **SMART** on the Installer Remote (see note above regarding remote with SMART key).
2. Use the Left/Right arrow keys on the Installer Remote to select the desired application, and then press **OK**.
3. On your device, launch the same application, and use the appropriate options (typically available via Settings) to initiate a connection/pairing with the TV. You may also need to access the Settings options from the application on the TV to complete the pairing operation. Follow the on-screen instructions.

Once the connection/pairing is successful, you will be able to view media from the application on the TV.

Reference: Using Media Share Features (Cont.)

SoftAP

The following steps describe how to access and use the SoftAP feature.

Note: This procedure describes how to access SoftAP from the TV's General Menu. It is also possible to access SoftAP using the Wi-Fi Service option available from the TV's Smart Launcher (via the PORTAL key on the remote control if the Pro:Centric application is not loaded or, depending on the remote control being used [in any mode], via the SMART key).

1. Turn ON the TV, and then press **MENU** on the Installer Remote to display the TV menus (either the setup menus or the Function Menu depending on whether the TV is or is not in Pass-through Mode).
2. Use the Up/Down arrow keys to select/highlight the **General** menu icon, and then press **OK**.
3. In the General Menu, use the Up/Down arrow keys to select **SoftAP**, and then press **OK**.



Note: The example at left shows the General Menu when the TV is in Pass-through Mode. The SoftAP screen is the same whether the TV is or is not in Pass-through Mode.

Note: If SoftAP is currently grayed out, make sure a wired LAN connection has been established.

4. When you initially access the SoftAP screen, the OFF/ON toggle button at the top right of the screen is selected/highlighted by default. If SoftAP is currently OFF, press **OK** on the Installer Remote to turn SoftAP ON. When SoftAP is ON, the SoftAP access information, including the SSID and security key, is displayed in the lower half of the screen.
5. Make sure Wi-Fi is turned ON on your device, and then look for the TV's SSID in the list of available Wi-Fi networks. Initiate the connection, and enter the security key as requested.

Once a device is connected successfully to the TV's network, you can use it to access the Internet. Up to five devices may be connected at a time; the Number of Connected Devices field in the SoftAP screen shows the number of devices currently connected to the TV Wi-Fi access point.

Note: A wired network connection MUST be established in order for guests to use SoftAP/Wi-Fi Service. Also, the SoftAP/Wi-Fi Service feature may only be used while the TV is turned ON.

Note: If the Wi-Fi frequency is not automatically detected, set the frequency in the device(s) to 2.4 GHz.

Reference: 24/28LV760M Rear and Side Jack Panels

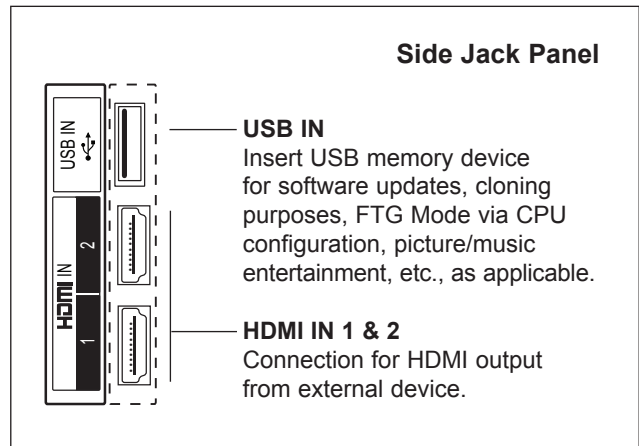
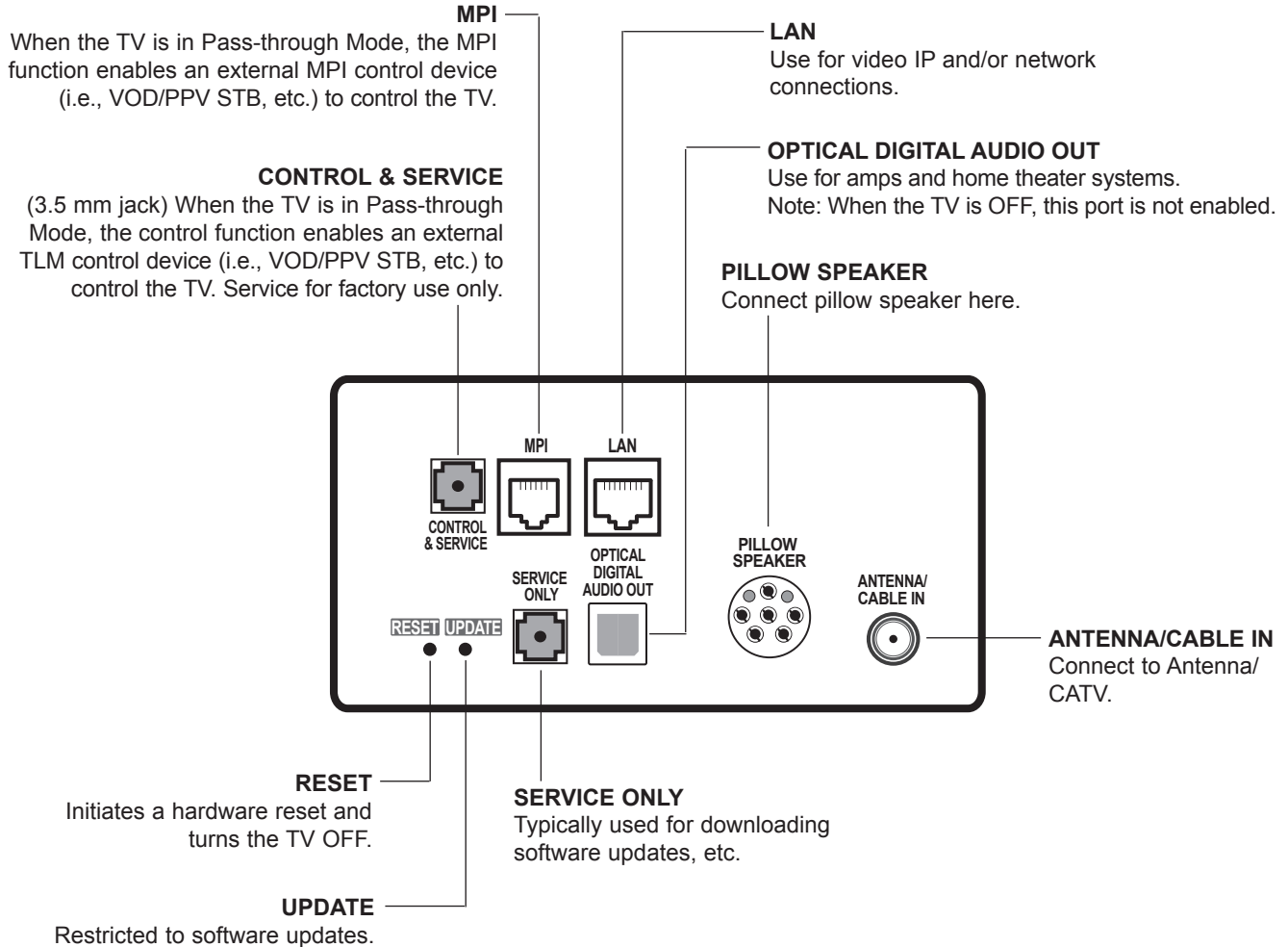

Reference: 32LV760M Rear and Side Jack Panels

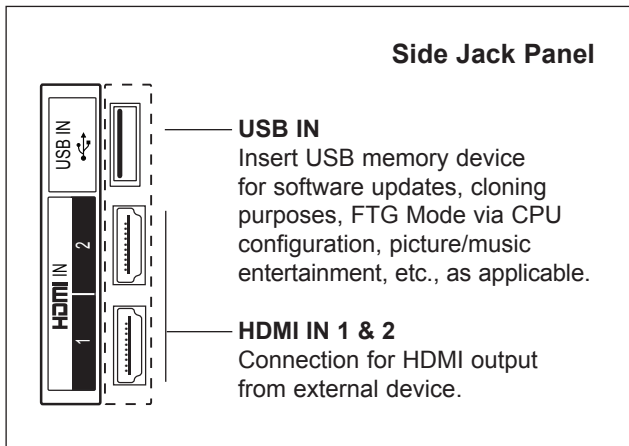
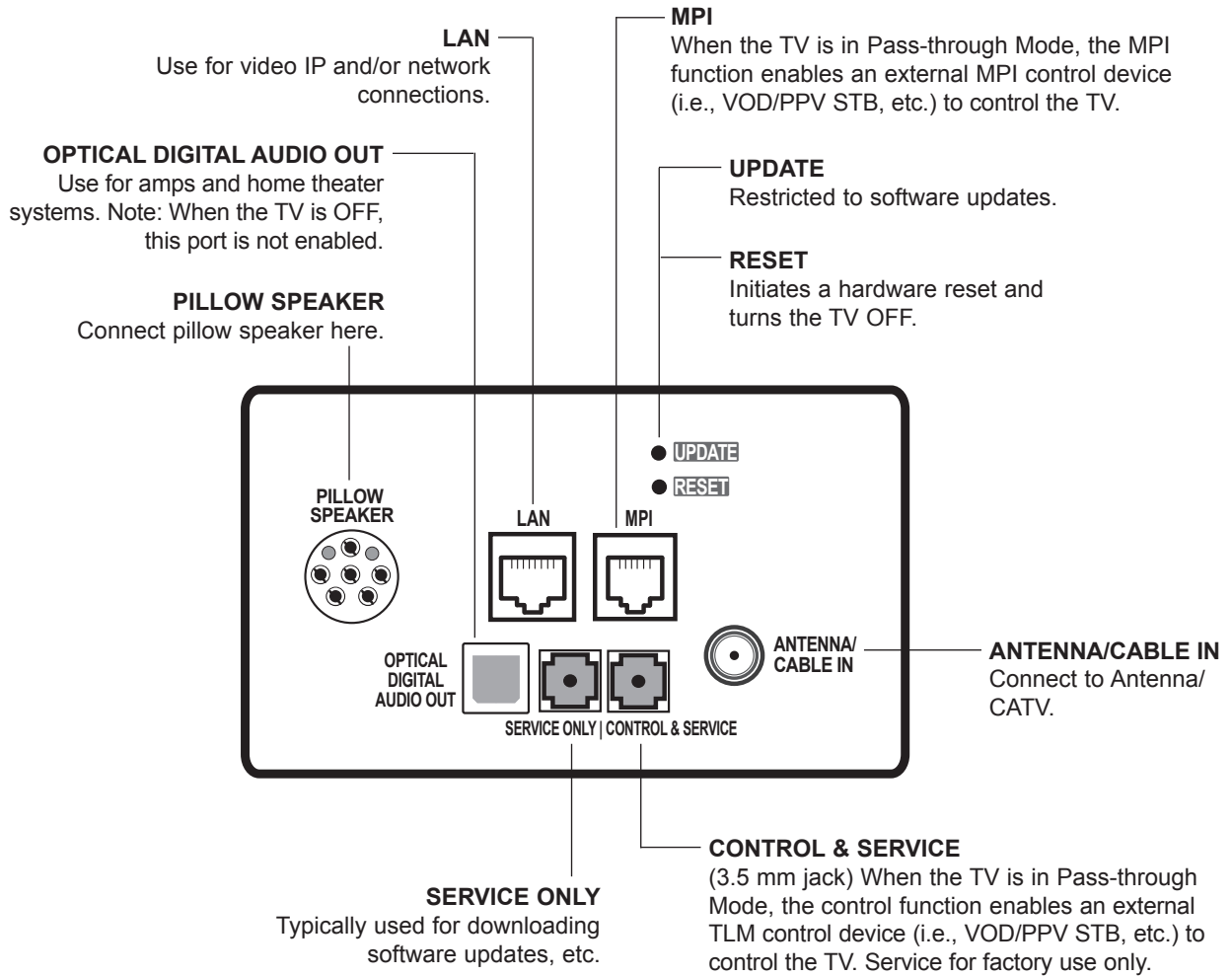

Reference: Installer Remote Control Typical Key Functions

An LG Installer Remote is required to set up and operate the TV. The LG Installer Remote illustrated below shows typical remote control functions and is provided for reference only.

TV LG1/TV LG2 & TV Z1/TV Z2
Selects the LG or Zenith IR codes sent by the remote. In order for the TV to respond, this setting must match the setting in the TV.

Numbers (0 - 9) & DASH
Use to enter a channel or program number. Dash is used for sub-channel numbers such as 9-1, 9-2, etc.

FLASHBK (Flashback)
Returns to the previously tuned channel.

CHANNEL UP/DOWN
Changes channels based on channels in the channel lineup.

VOLUME UP/DOWN
Increases/decreases sound level.

Arrows (Up/Down/Left/Right) & OK
Use to navigate on-screen menus, direct tune channels, and adjust TV settings.

CH. BANK
Selects Channel Bank 1, 2, 3, or 4 when Hospital Mode is enabled and the TV is in PTC-CTV Mode or FTG Mode via CPU. Otherwise, this button displays available Aux inputs.

CH. PREVIEW
Displays and exits the Channel Preview/Banks Setup Menu (TV in PTC-CTV mode only).

MUTE
Switches sound On or Off.

TIMER
Sets the amount of time before the TV automatically turns itself Off.

ALARM
Enables users to schedule a one-time "alarm" event, in which the TV turns itself On at the user-specified time.

EXIT
Clears all on-screen displays and returns to program viewing.

POWER
Turns the TV On or Off.

MENU
Displays and removes the TV setup menus (or, if applicable, the Function Menu).

PORTAL
Displays and removes the Pro:Centric interactive menu.

INFO
Displays channel information.

GUIDE
Displays and removes the Pro:Centric channel guide/EPG.

↵ (RETURN)
Returns one level to the previous menu/display.

Color buttons access special functions in some menus.

CC
Activates subtitles, unless the Channel Preview/Banks Setup Menu is currently on the screen (applicable for PTC-CTV Mode only), in which case this option displays the Lock (V-Chip) Menu.

SAP
Analog Mode: Selects MTS sound (Mono, Stereo, or SAP). DTV Mode: Changes the audio program language, if additional languages are available. *

* SAP notes:

- If SAP is selected and no SAP is provided, sound may not be heard on channel.
- Each channel may have its own SAP setting.
- Each time digital channels are tuned, the TV attempts to locate the default audio program language. If the default audio program language is not available, the TV will use the first available audio program.

Reference: LG Pro:Centric Patient Remote and Pillow Speaker

LG Pro:Centric patient remotes and/or pillow speakers are available for purchase (see patient remote example at right and pillow speaker example on following page). For additional information and/or to purchase an LG Pro:Centric patient remote or pillow speaker, please contact your LG service representative.

Patient Remote and Pillow Speaker Functionality

Both the LG Pro:Centric patient remote and the LG Pro:Centric pillow speaker provide access to Pro:Centric application features (via PORTAL, INFO, and GUIDE buttons). See also “Installer Remote Control Typical Key Functions” on the previous page for further information on button functions. The patient remote also provides multi-code capability as described below.

Set the Patient Remote IR Code Scheme (Multi-code Feature)

This section describes how to set the LG Pro:Centric patient remote to send unique IR codes based on “bed number” in a multi-TV single room installation. The remote may be set from Bed 1 to Bed 4.

Note: The TV will always respond to the standard LG Installer Remote IR code scheme, i.e., you can always use an Installer Remote with the TV, regardless of its multi-code IR setting.

The following procedure describes how to set the bed number in the TV’s Installer Menu and in the patient remote.

1. Installer Menu item 020 FEATURE LEVEL determines the additional IR code scheme to which the TV will respond. Access the Installer Menu, and set item 020 to the desired value (16–19).

The patient remote must now be set to match the FEATURE LEVEL setting. That is, if item 020 is set to 17 for Bed 2, the patient remote must also be set to multi-code Bed 2.

Note: By default, the patient remote IR code scheme is the same as the standard LG Installer Remote IR code scheme.

2. On the patient remote, press and hold **OK** along with the desired (bed) number key (1–4).
The LED at the top left of the remote will light for three seconds and then turn OFF.
3. Once the LED turns OFF, release both keys on the remote.
4. Verify that the patient remote now controls the TV, based on your settings.

Note: If necessary, you can restore the patient remote IR code scheme to the standard LG Installer Remote IR code scheme by pressing and holding **OK** on the remote along with the “0” key.



**Typical LG
Pro:Centric Patient
Remote**

Reference: LG Pro:Centric Patient Remote and Pillow Speaker (Cont.)

USB Media Navigation

This section provides a brief overview of the LG Pro:Centric patient remote and LG Pro:Centric pillow speaker navigation tools for use with USB media files (photos, videos, music, etc.).

Note: The LG Pro:Centric pillow speaker is currently the only pillow speaker that enables users to navigate and play/view USB media files.

Note: Refer to the Owner's Manual for detailed information on USB memory device requirements and the types of media supported by the LV760M TVs.

1. Insert the USB memory device into the TV's USB port.

Once the TV detects the USB device, a SmartShare icon will be displayed on the screen. Press **OK** (patient remote) or **ENTER** (pillow speaker) to access the Smart Share application.

2. Use the arrow keys on the patient remote /pillow speaker to select/highlight the desired option(s) in the Smart Share screen, and then press **OK/ENTER**.
3. Within each USB media directory (Photos, Videos, or Music):
 - Use the arrow keys on the patient remote/pillow speaker to navigate from one folder or file to another, and press **OK/ENTER** to open or play a selected folder or file.
 - Use the arrow keys on the patient remote/pillow speaker, as necessary, to scroll through all available files.
 - In View and Play modes, you typically can use the patient remote/pillow speaker to navigate to another directory level (without exiting the Smart Share application).
 - To exit the Smart Share application, press **↵** (patient remote) or **RETURN** (pillow speaker). The TV's Smart Launcher will be displayed along the bottom of the screen, and you can use the Left/Right arrow keys on the patient remote/pillow speaker to select **LiveTV** to return to program viewing. If you wish to relaunch the Smart Share application, you must physically remove and then reinsert the USB memory device.

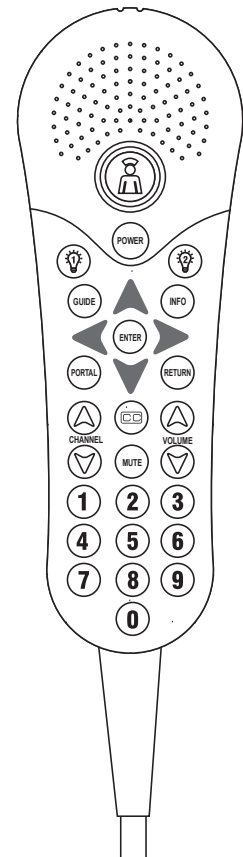

Typical LG
Pro:Centric Pillow
Speaker

Reference: Pillow Speaker Setup

The pillow speaker will only be functional after the Express Script/Custom Master TV Setup and/or cloning/USB configuration procedures are complete.

Note: When Installer Menu item 027 HOSPITAL MODE is set to 254 (factory default value), there is no power (voltage) supplied to the pillow speaker interface.

Connecting a Pillow Speaker to the TV

Connect the pillow speaker (see example at right) to the PILLOW SPEAKER interface on the rear jack panel of the TV.

 **Caution:** Use a pillow speaker that is a UL recognized pendant control bearing the warning: “Risk of fire if used in oxygen enriched atmosphere. Keep pendant control away from oxygen equipment.”

Controlling the TV with Serial Data

These TV models are capable of being controlled by a single-wire, serial data signal. This is an LG patented technology and is being implemented by certain brands of “smart” pillow speakers.

Pillow Speaker Interface

This connector provides an interface for patient-pendant remote control or entertainment audio and nurse call systems. All lines are isolated from the AC power line and earth ground (a transformer isolates the DC supply, optocouplers isolate the control lines, and a transformer isolates the audio). For positive voltage configurations (e.g., for Zenith/Philips pillow speakers), +12 volts/+5 volts is provided on pin 3 (Channel Up/Data In) in reference to pin 4 (Common). For negative voltage configurations (e.g., for RCA pillow speakers), +5 volts is provided on pin 4 in reference to pin 3.

The following table describes the pillow speaker interface pinout (see also diagram at right).

Pin No.	Description
1	Analog external control for TV ON/OFF.
2	No connection
3	Analog external control for Channel Up or Serial Data In.
4	Common connection for control, data, and audio output.
5	Isolated Audio Output. Nominal 14 ohm source impedance with short circuit protection. Audio level control provided by an external low-impedance, pad-type volume control or serial data Volume Up/Down keys.
6	Analog external control for Channel Down.

Controlling the TV with Mechanical Switches

A typical analog pillow speaker with mechanical switches will momentarily connect pin 1, 3, or 6 to pin 4 (Common) to control Power ON/OFF, Channel Up, or Channel Down (see schematic at right). These pins are at +13 volts DC (when measured from pin 4) with the switches open. Typical current draw is 8 mA when a switch is closed. (This operation is identical to previous models using the 5-wire interface, except that only +7 volts DC was supplied and current draw was only 2.5 mA.)

Typical Pillow Speaker (Serial Data Control)

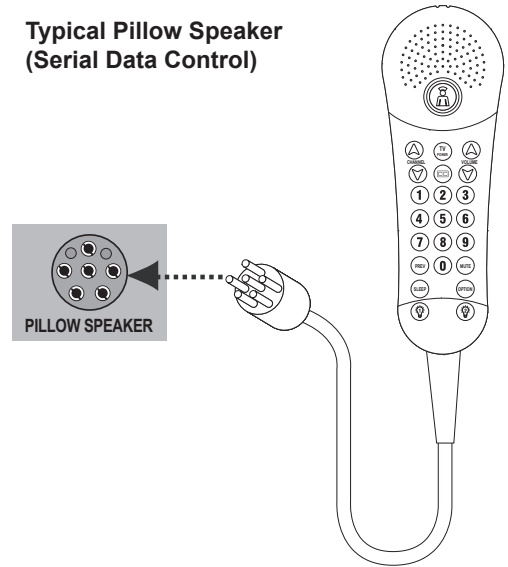

Pillow Speaker Interface Pinout

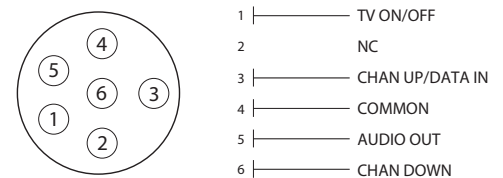

Typical Schematic for Analog Pillow Speaker

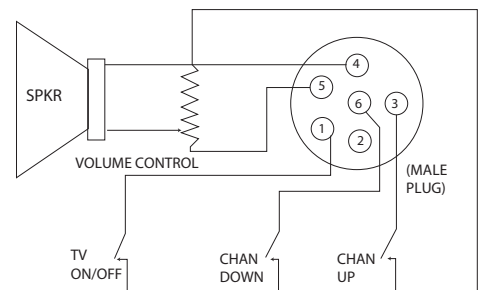

General Guidelines: Choosing a Location for Installing a VESA Standard Mount

To the right are some examples of VESA standard mounts. Since there are numerous types of stands and mounts available, only a few are shown here. Refer to the instructions provided with the TV stand that will be used to mount the TV. Be sure the style of stand selected is capable of supporting the weight of the TV and is appropriate for the application.

Wall Mounts

If the mount will be on a wall, a typical wooden stud behind the wall board would be the preferred choice for a location to attach the wall mount. The wall mount location chosen should be appropriate for drilling holes and have available the required power source as well as antenna/cable and any other equipment leads as necessary.

Pedestal Mounts and Stands

A sturdy surface on a desk or other similar flat table-like furniture would be the appropriate location for mounting a pedestal-style TV stand.

Most stands are designed so that the wiring is threaded through the stand itself or a loop-through style clamp so that the wiring is neatly bunched and not strung in such a way as to create a potential hazard to the user. (Some stands are portable and can be moved from one location to another.) Be sure all safety considerations are followed.

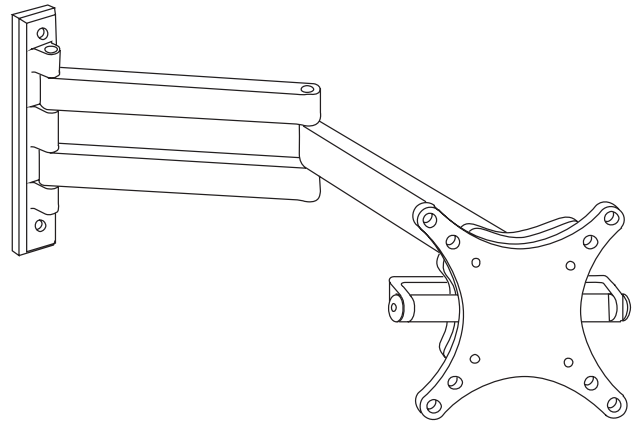

Typical Wall Stud Type Mount with Swivel Bracket

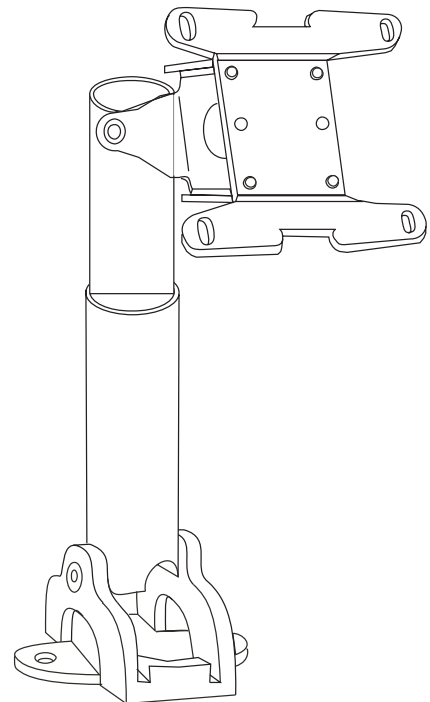

Typical Pedestal Type Mount with Swivel Bracket

Reference: TLM Communication Parameters

CONTROL & SERVICE Jack Configuration

**CONTROL & SERVICE
3.5 mm Jack on TV**

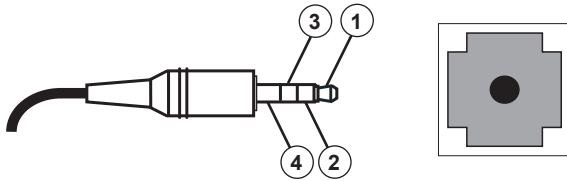

**CONTROL & SERVICE Jack
4 Contact Configuration**

Contact	Description
TXD	Connects to 1 (Tip)
RXD	Connects to 2 (Ring 1)
IR Data Pass-through	Connects to 3 (Ring 2)
GND	Connects to 4 (Sleeve)

Communication Parameters

- Baud rate: 9600 bps (UART)
- Data length: 8 bits
- Parity: None
- Stop bit: 1 bit
- Communication Code: ASCII

Command Reference List

Note: Commands may work differently depending on model and signal.

		Command 1	Command 2	Data (Hexadecimal)			Command 1	Command 2	Data (Hexadecimal)
01.	Power	k	a	00 / 01	11.	OSD Select	k	l	00 / 01
02.	Aspect Ratio	k	c	(see page 110)	12.	Remote Control Lock Mode	k	m	00 / 01
03.	Screen Mute	k	d	00, 01, 10	13.	Balance	k	t	00–64
04.	Volume Mute	k	e	00 / 01	14.	Color Temperature	x	u	00–64
05.	Volume Control	k	f	00–64	15.	Equalizer	j	v	(see page 112)
06.	Contrast	k	g	00–64	16.	Tune Command	m	a	(see page 112)
07.	Brightness	k	h	00–64	17.	Channel Add/Delete	m	b	00 / 01
08.	Color	k	i	00–64	18.	Key	m	c	(see page 113)
09.	Tint	k	j	00–64	19.	Control Backlight	m	g	00–64
10.	Sharpness	k	k	00–32	20.	Input Select (Main)	x	b	(see page 113)

Transmission / Receiving Protocol

Transmission

[Command1][Command2][][Set ID][][Data][Cr]

[Command 1] First command to control the TV (j, k, m or x).

[Command 2] Second command to control the TV.

[Set ID] You can adjust the [Set ID] to choose desired monitor ID number in the General Menu. Adjustment range is 1 to 99. If [Set ID] value is set to '0', every connected set can be controlled.

Note: [Set ID] is indicated as decimal (1 to 99) in the General Menu and as hexadecimal (0x00 to 0x63) on transmission/receiving protocol.

[DATA] To transmit command data (hexadecimal). Transmit 'FF' data to read status of command.

[Cr] Carriage Return (ASCII code "0x0D")

[] Space (ASCII code "0x20")

OK Acknowledgement

[Command2][][Set ID][][OK][Data][x]

This set transmits ACK (acknowledgement) based on this format when receiving normal data. At this time, if the data is data read mode, it indicates present status data. If the data is data write mode, it returns the data of the PC.

Error Acknowledgement

[Command2][][Set ID][][NG][Data][x]

This set transmits ACK (acknowledgement) based on this format when receiving abnormal data from non-viable functions or communication errors.

Data 00: Illegal Code

Real data mapping (Hexadecimal : Decimal)

- When you enter the [data] in hexadecimal, refer to following conversion table.
- Channel Tune (ma) Command uses two-byte hexadecimal value ([data]) to select the channel number.

00: Step 0	32: Step 50 (Set ID 50)	FE: Step 254
01: Step 1 (Set ID 1)	33: Step 51 (Set ID 51)	FF: Step 255
...
0A: Step 10 (Set ID 10)	63: Step 99 (Set ID 99)	01 00: Step 256
...
0F: Step 15 (Set ID 15)	C7: Step 199	27 0E: Step 9998
10: Step 16 (Set ID 16)	C8: Step 200	27 0F: Step 9999
...

Reference: TLM Communication Parameters (Cont.)

TLM Command Detailed Descriptions

Note: Commands may work differently depending on model and signal.

01. Power (Command: k a)

- To control TV power (ON/OFF).*

Transmission

[k][a][][Set ID][][Data][Cr]

Data 00: Power Off 01: *Power On

Ack

[a][][Set ID][][OK/NG][Data][x]

- To show TV power status (ON/OFF).*

Transmission

[k][a][][Set ID][][FF][Cr]

Ack

[a][][Set ID][][OK][Data][x]

* Similarly, if other functions transmit "FF" data based on this format, Acknowledgement feedback presents status about each function.

02. Aspect Ratio (Command: k c)

To adjust the aspect ratio. You can also adjust the aspect ratio in the Quick Settings Menu or Picture Menu.

Transmission

[k][c][][Set ID][][Data][Cr]

Data 01: Normal Screen (4:3)
02: Wide Screen(16:9)
04: Zoom
06: Set by Program/Original
09: Just Scan
10 to 1F: Cinema Zoom 1 to 16
0C: Cinemascope (21:9)

Ack

[c][][Set ID][][OK/NG][Data][x]

- Using the PC input, you can select either 16:9 or 4:3 screen aspect ratio.
- In DTV/HDMI/Component mode (high-definition), Just Scan is available.
- Full wide mode may work differently based on model and is supported for DTV fully and ATV / AV partially.

03. Screen Mute (Command: k d)

To control screen mute.

Transmission

[k][d][][Set ID][][Data][Cr]

Data 00: Screen Mute Off (Picture On)
Video Mute Off
01: Screen Mute On (Picture Off)
10: Video Mute On*

Ack

[d][][Set ID][][OK/NG][Data][x]

* In case of Video Mute On only, TV will show OSD. In case of Screen Mute On, TV will not show OSD.

04. Volume Mute (Command: k e)

To control volume mute. You can also adjust mute using the MUTE key on the remote control.

Transmission

[k][e][][Set ID][][Data][Cr]

Data 00: Volume Mute On (Volume Off)
01: Volume Mute Off (Volume On)

Ack

[e][][Set ID][][OK/NG][Data][x]

05. Volume Control (Command: k f)

To adjust volume. You can also adjust volume with the volume keys on the remote control.

Transmission

[k][f][][Set ID][][Data][Cr]

Data Min: 00 to Max: 64

Ack

[f][][Set ID][][OK/NG][Data][x]

06. Contrast (Command: k g)

To adjust screen contrast. You can also adjust contrast in the Picture Menu.

Transmission

[k][g][][Set ID][][Data][Cr]

Data Min: 00 to Max: 64

Ack

[g][][Set ID][][OK/NG][Data][x]

Reference: TLM Communication Parameters (Cont.)

07. Brightness (Command: k h)

To adjust screen brightness. You can also adjust screen brightness in the Picture Menu.

Transmission

[k][h][][Set ID][][Data][Cr]

Data Min: 00 to Max: 64

Ack

[h][][Set ID][][OK/NG][Data][x]

08. Color (Command: k i)

To adjust the screen color. You can also adjust color in the Picture Menu.

Transmission

[k][i][][Set ID][][Data][Cr]

Data Min: 00 to Max: 64

Ack

[i][][Set ID][][OK/NG][Data][x]

09. Tint (Command: k j)

To adjust the screen tint. You can also adjust tint in the Picture Menu.

Transmission

[k][j][][Set ID][][Data][Cr]

Data Red: 00 to Green: 64

Ack

[j][][Set ID][][OK/NG][Data][x]

10. Sharpness (Command: k k)

To adjust the screen sharpness. You can also adjust sharpness in the Picture Menu.

Transmission

[k][k][][Set ID][][Data][Cr]

Data Min: 00 to Max: 32

Ack

[k][][Set ID][][OK/NG][Data][x]

11. OSD Select (Command: k l)

To select OSD (On Screen Display) status when controlling remotely.

Transmission

[k][l][][Set ID][][Data][Cr]

Data 00: OSD Off 01: OSD On

Ack

[l][][Set ID][][OK/NG][Data][x]

12. Remote Control Lock Mode (Command: k m)

To lock both the display panel button functions and remote control IR features.

Transmission

[k][m][][Set ID][][Data][Cr]

Data 00: Lock Off 01: Lock On

Ack

[m][][Set ID][][OK/NG][Data][x]

- If the TV is turned OFF (by Off timer or “ka” or “mc” command) while Remote Control Lock Mode is on, it is not possible to turn the TV back ON via the POWER key on the display panel or the remote control.
- When the TV’s power is AC-cycled, Remote Control Lock is released.

13. Balance (Command: k t)

To adjust sound balance. You can also adjust balance in the Sound Menu.

Transmission

[k][t][][Set ID][][Data][Cr]

Data Min: 00 to Max: 64

Ack

[t][][Set ID][][OK/NG][Data][x]

14. Color Temperature (Command: x u)

To adjust color temperature. You can also adjust color temperature in the Picture Menu.

Transmission

[x][u][][Set ID][][Data][Cr]

Data Min: 00 to Max: 64

Ack

[u][][Set ID][][OK/NG][Data][x]

Reference: TLM Communication Parameters (Cont.)

15. Equalizer (Command: j v)

To adjust EQ of the TV.

Transmission

```
[j][v][ ][Set ID][ ][Data][Cr]
```

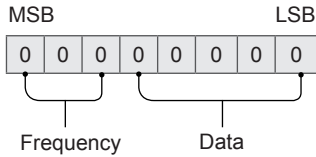

7	6	5	Frequency	4	3	2	1	0	Step
0	0	0	1st Band	0	0	0	0	0	0 (decimal)
0	0	1	2nd Band	0	0	0	0	1	1 (decimal)
0	1	0	3rd Band	-	-	-	-	-	-
0	1	1	4th Band	1	0	0	1	1	19 (decimal)
1	0	0	5th Band	1	0	1	0	0	20 (decimal)

Ack

```
[v][ ][Set ID][ ][OK/NG][Data][x]
```

Depends on model and can be adjusted when sound mode is EQ adjustable value.

16. Tune Command (Command: m a)

To tune the channel to the following Physical Major/Minor Channel number.*

Transmission

```
[m][a][ ][Set ID][ ][Data0][ ][Data1][ ][Data2][ ][Data3][ ][Data4][ ][Data5][Cr]
```

* This command may work differently depending on model and signal.

• Analog Antenna/Cable

- [Data0]: Physical Channel number
 - Antenna (ATV): 02–45 (Decimal: 2–69)
 - Cable (CATV): 01–7D (Decimal: 1–125)
- [Data1–4]: Major/Minor Channel number
 - Data1 & Data2: xx (Don't care)
 - Data3 & Data4: xx (Don't care)
- [Data5]: Input Source (Analog)
 - 00: Antenna TV (ATV)
 - 01: Cable (CATV)

• Digital Antenna/Cable

- [Data0]: Physical Channel number*
 - Antenna (DTV): 02–45 (Decimal: 2–69)
 - Cable (CADTV): 01–87 (Decimal: 1–135)
- * When [Data5] is 22 or 26 (see below), use 00 for [Data0].
- [Data1][Data2]: Major Channel number
 - Data1: High byte Channel Data
 - Data2: Low byte Channel Data
 - 00 01–27 0F (Decimal: 1–9999)
- [Data3][Data4]: Minor Channel number
 - Data3: High byte channel data
 - Data4: Low byte channel data
 - 00 00–03 E7 (Decimal: 0–999)
- [Data5]: Input Source (Digital)
 - 02: Antenna TV (DTV), Use Physical Channel number
 - 06: Cable TV (CADTV), Use Physical Channel number
 - 22: Antenna TV (DTV), Do not use Physical Channel number (see also [Data0] * above)
 - 26: Cable TV (CADTV), Do not use Physical Channel number (see also [Data0] * above)
 - 46: Cable TV (CADTV), Use Physical Major Channel number only (One Part Channel)
 - 66: Cable TV (CADTV), Use Major Channel number only (One Part Channel)

Two bytes are available for each Major and Minor Channel number. The high byte is 00 unless the channel number exceeds 255.

Tune Command Examples:

Example 1: Tune to analog (NTSC) channel 35
 Set ID = All = 00
 Data0 = Channel Data is 35 = 23
 Data1 & Data2 = No Major = 00 00
 Data3 & Data4 = No Minor = 00 00
 Data5 = Analog Cable TV = 01
 Total = ma 00 23 00 00 00 01

Example 2: Tune to digital (ATSC) channel 30-3
 Set ID = All = 00
 Data0 = Don't know Physical = 00
 Data1 & Data2 = Major is 30 = 00 1E
 Data3 & Data4 = Minor is 3 = 00 03
 Data5 = Digital Antenna TV = 22
 Total = ma 00 00 00 1E 00 03 22

Ack

```
[a][ ][Set ID][ ][OK][Data0][Data1][Data2][Data3][Data4][Data5][x][a][ ][Set ID][ ][NG][Data0][x]
```

Reference: TLM Communication Parameters (Cont.)

17. Channel Add/Delete (NTSC) (Command: m b)

To set the saved channel status.

Transmission

[m][b][][Set ID][][Data][Cr]

Data 00: Delete
01: Add

Ack

[b][][Set ID][][OK/NG][Data][x]

18. Key (Command: m c)

To send IR remote key code.

Transmission

[m][c][][Set ID][][Data][Cr]

Data Key code. See Key Codes table on page 114.

Ack

[c][][Set ID][][OK/NG][Data][x]

19. Control Backlight (Command: m g)

To control the backlight.

Transmission

[m][g][][Set ID][][Data][Cr]

Data Min: 00 to Max: 64

Ack

[g][][Set ID][][OK/NG][Data][x]

20. Input select (Command: x b)

To select input source for main picture.*

Transmission

[x][b][][Set ID][][Data][Cr]

Data	00: DTV	01: CADTV
	02: Satellite DTV	10: ATV
	11: CATV	
	20: AV or AV 1	21: AV 2
	40: Component 1	41: Component 2
	60: RGB	
	90: HDMI 1	91: HDMI 2
	92: HDMI 3	93: HDMI 4

Ack

[b][][Set ID][][OK/NG][Data][x]

* This function depends on model and signal.

Reference: TLM Communication Parameters (Cont.)

Key Codes

The following table provides key codes for a typical LG hospital model Installer Remote.

Note: Some keys are not applicable to all models.

Code (Hexa)	Function	Code (Hexa)	Function
00	CH +	C0	⊙ (Green)
01	CH -	C1	⊙ (Red)
02	VOL +	C2	⊙ (Yellow)
03	VOL -	C3	⊕ (Blue)
06	▶	8E	▶▶
07	◀	8F	◀◀
08	POWER ⏻	B0	▶
09	MUTE/DELETE	B1	■
10–19	Numbers (0–9)	BA	
28	BACK ↵	AA	INFO ⓘ
39	CC CHAR/NUM	AB	GUIDE
40	▲	7C	SMART
41	▼	7E	ⓂIMPLINK
43	MENU	DC	3D/*
44	OK/ENTER Ⓞ	60	PIP/*
0B	INPUT	61	PIP INPUT/*
0C	PORTAL	63	SWAP/*
0E	TIMER	71	PIP CH +/*
1A	FLASHBK	72	PIP CH -/*
4C	—	79	RATIO
5B	EXIT	91	VD/*

General Troubleshooting (Some Quick and Easy Tips for Resolving Problems)

Installation

Symptom	Possible Cause(s)	Possible Solution(s)
Cannot direct enter channel number.	(TV in Pass-through Mode) Installer Menu item 028 CH. OVERRIDE is set to 0, i.e., disabled (recommended setting).	If Installer Menu item 028 CH. OVERRIDE is set to 0, only channels that are active in the TV's channel lineup can be selected. Set CH. OVERRIDE to 1 to allow access for direct keypad entry to all channels.
	(TV not in Pass-through Mode) The channel entered is not included in the applicable Channel Map.	Channel access is restricted to channels included in the applicable Channel Map, for example the FTG Channel Map if the TV is in FTG Mode or the Pro:Centric Direct Channel Map if the TV is in Application Tuning Mode with Pro:Centric Direct. If necessary, make changes to the Channel Map using the appropriate application/content editor.
No channels present after Express Script.	Auto Tuning not run.	Refer to Express Script procedure. Auto Tuning must be run in order for the channel lineup to be populated. To reactivate the Express Script, restore the TV to a factory default condition.

Picture Reception and Sound

Symptom	Possible Cause(s)	Possible Solution(s)
No picture.	TV is turned OFF.	<ul style="list-style-type: none"> • Turn TV ON. • Power failure?
	Antenna/cable not connected.	Connect antenna/cable signal to TV.
	Connections incorrect.	Check connections on TV.
	MPI not connected.	If applicable, connect MPI cable to MPI device.
	Encrypted program.	Try another channel.
	Wrong tuning band.	Adjust Installer Menu settings.
Normal picture, poor or no sound.	Audio muted.	Press MUTE or use Volume Up key to increase sound level.
	Broadcast problem.	Try a different channel.
	Pillow/TV speaker not configured properly.	Check that Installer Menu items 020 FEATURE LEVEL and 027 HOSPITAL MODE are set as required. Also, if applicable, select TV Speaker in the Audio Menu.

Erratic Operation

Symptom	Possible Cause(s)	Possible Solution(s)
Installer Menu setup.	Wrong Installer Menu settings.	Adjust Installer Menu settings as required.

Installer Remote

Symptom	Possible Cause(s)	Possible Solution(s)
Remote doesn't work.	Remote not in TV Mode.	Depending on the remote used, you may need to use a MODE key to put the remote into TV Mode.
	Not aimed at IR receiver.	Point remote at IR receiver on TV.
	Remote too far from IR receiver or IR path is obstructed.	Move remote closer to IR receiver on TV, darken room, and/or remove obstructions.
	MPI not connected.	If applicable, connect MPI cable to MPI device.
	Weak batteries.	Replace batteries.
	Wrong battery polarity.	Check that "+" and "-" match in battery compartment.
	Too much light in room.	Dim room light.
Remote IR codes do not match setting(s) in TV.	Make sure the Installer Remote is compatible. Contact your LG representative, as necessary. Then, check settings both in the TV and on the remote. IR codes sent by the remote must match the setting(s) in the TV.	

Troubleshooting (Cont.)

Commercial Mode Check

Use this flowchart to determine whether the TV is currently in Commercial Mode.

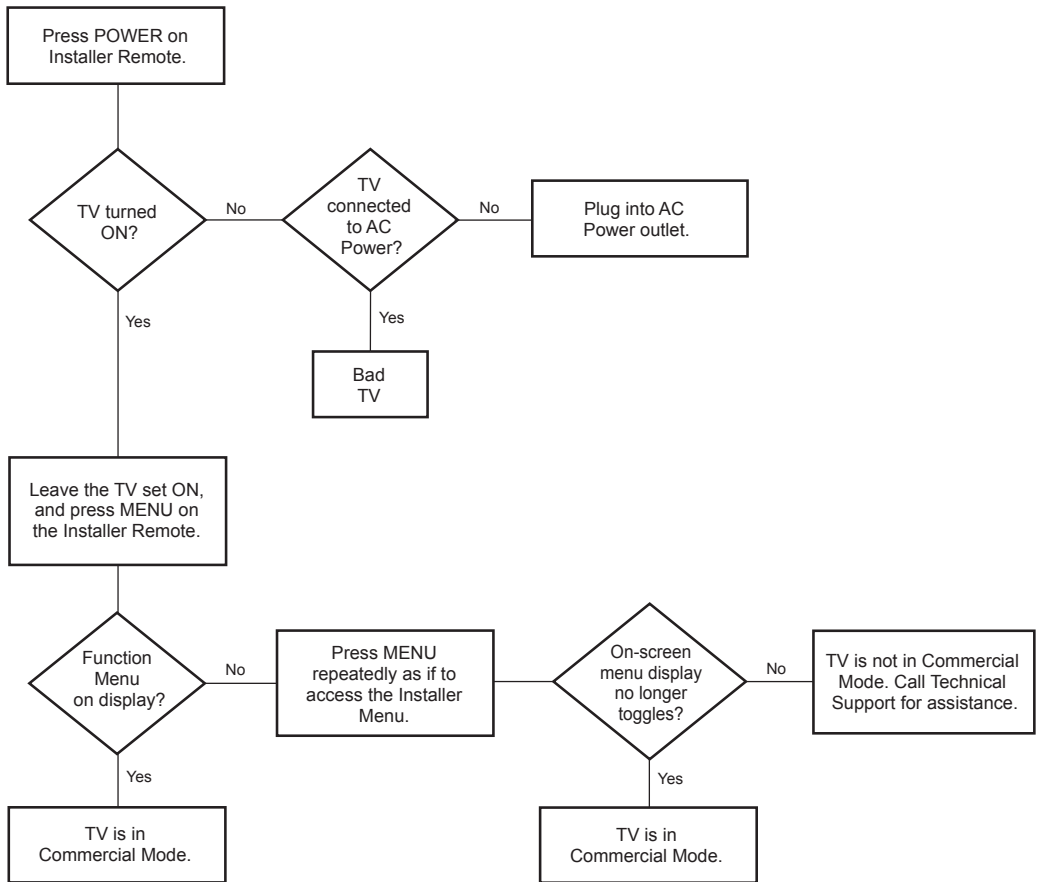

Troubleshooting (Cont.)

Channel Banks Setup Troubleshooting

Symptom	Possible Cause	Possible Solution
Channel is blanked in all channel banks.	Blanking a channel in one channel bank will make it blank in all channel banks.	Modify the channel attribute(s), if desired, using the Cloud Configuration Tool / Channel Map utility. See also the Channel Map web page overview on page 67. Restore normal operation by unchecking the "Blank Video" checkbox for the channel. Note that normal operation will be restored to the channel in all channel banks.
"Inactive TV" message appears and then TV turns OFF.	TV is set up to display "Inactive TV" message if all channels are deleted from Channel Bank 4.	Use the Installer Remote to select another channel bank (1, 2, or 3) to return TV to normal operation.
Channel found during Auto Tuning does not tune in with Channel Up/Down.	Channel was deleted in currently selected channel bank.	Premium channels may only be available on another channel bank. Modify the channel bank allocation(s) for the channel, if desired, using the Cloud Configuration Tool / Channel Map utility. See also the Channel Map web page overview on page 67.
When CH. BANK key on Installer Remote is pressed, TV shows Input List Menu.	Installer Menu item 027 HOSPITAL MODE is set to 0 (i.e., Hospital Mode is disabled).	Installer item 027 must be set appropriately (i.e., Hospital Mode must be enabled) in order for channel banks to be available. If the TV is in CPU-CTV or PTC-CTV Mode, access the Installer Menu and set item 027 as applicable. If the TV is in FTG Mode via CPU, use the Cloud Configuration Tool / Installer Menu utility to update Installer Menu item #027.

Glossary of Terms

Application Tuning Mode

LG commercial TV mode that enables the TV's Channel Map to reside in a Pro:Centric application.

Channel Lineup

Channels set in the TV memory, via Auto Tuning/manual editing.

Channel Map

Typically refers to a logical channel mapping of physical RF channels (for example, an FTG Channel Map). This allows digital channels, like analog channels, to be tuned without requiring the dash key. Also, channels (digital or analog) can be arranged in any order that seems logical for customer tuning/viewing.

Cloning

The process of capturing a Master TV Setup and transferring it to a Target TV using a USB memory device.

Commercial Mode

A mode of operation that provides a broad range of commercial TV features based on control (settings) provided by the PTC and/or an MPI control device.

CPU

The TV's Central Processing Unit. Responsible for the presentation of video and audio from content received via the TV's tuner or Aux inputs.

E-Z Installation

Enables splash screen image, TV configuration, and software/firmware file downloads to selected TV models from a Pro:Centric server. Managed and administered via the appropriate Pro:Centric Admin Client.

Express Script

Hospital model TV configuration script that provides streamlined configuration for FTG Mode via CPU operation in a hospital setting, including a configuration option for Pro:Centric operation.

EZ-Manager Wizard

Lodging/hospital model TV configuration wizard that provides configuration options for Pro:Centric operation as well as an option for using a USB memory device to configure a TV.

FTG Mode

LG commercial TV mode that enables decryption of Pro:Idiom encrypted channels and logical channel mapping. TVs may be

configured locally using LG's proprietary Cloud Configuration Tool or remotely using an applicable head end device.

Function Menu

Available via Installer Remote "MENU" key. Indicates the TV is not in Pass-through Mode. Restricts menu options to a subset of the TV setup menus, allowing users to retain functional control, while disabling setup options.

Installer Menu

Defines commercial TV functionality based on the parameters set.

LG Free-To-Guest (FTG)

Refers to a particular commercial mode of operation within an LG TV. See also FTG Mode.

Logical Channel Number

A number assigned to either a physical or virtual channel number in a Logical Channel Map.

Major Channel Number

Typically, the RF channel number assigned to a digital video stream.

Master TV

A TV whose Channel Map and Installer Menu and TV setup menu settings have been configured as a Master TV Setup for cloning purposes.

Minor Channel Number

A sub-channel or program number assigned to the content embedded in the digital video stream.

MPI

Multiple Protocol Interface. An MPI port or, for some TV models, an MPI card slot provides external control options for solution providers.

Pass-through Mode

The TV's factory default mode of operation. TVs can be configured for stand-alone use or as Master TVs for cloning purposes, and/or TVs may be controlled externally in this mode.

Physical Channel Number

The major channel number assigned to represent a specific 6 MHz RF band as specified by either the broadcast or CATV channel plan. See CEA (formerly EIA) or NCTA specifications for further information.

Pro:Centric Application

LG content delivery and communication interface powered by Pro:Centric server, that provides interactive entertainment, weather, amenities, etc. information for end users. Two application options are available: Pro:Centric Java application or Pro:Centric Direct HTML application.

Pro:Centric Admin Client

Web editor/content wizard provided for service provider and customer configuration of Pro:Centric application and management elements. The proper Admin Client must be used in accordance with licensed (Java or HTML) application.

Pro:Idiom

Zenith proprietary security software that unlocks access to premium content to help assure rapid, broad deployment of HDTV and other high-value digital content.

PTC

Protocol Translation Controller. The commercial controller (microprocessor) of the commercial TV.

Target TV

A TV to which a Master TV Setup will be transferred.

TV Setup Menus

Available via Installer Remote "MENU" key in Pass-through Mode only. Menus provide access to TV setup and functional features.

USB Memory Device

A USB flash drive or USB storage device, etc. that can be used for TV configuration purposes (typically cloning or FTG Mode via CPU configuration) or for updating TV software.

Virtual Channel Number

An alias (virtual) channel number provided in the data stream, by the broadcaster, of a digital broadcast channel to be displayed by consumer TVs in place of the physical channel number. The major number is the same as the original analog channel number and the minor number is the nth program available in that digital video stream.

Document Revision History / Open Source Software Notice

Document Revision History

Date	Description
October 2017	Revision A: New document
March 2018	Revision B: IM item and CCT updates
April 2018	Revision C: Installer Menu updates

Product documentation is available online at: www.lg.com/us/business.

Open Source Software Notice

To obtain the source code under GPL, LGPL, MPL and other open source licenses, that is contained in this product, please visit <http://opensource.lge.com>. In addition to the source code, all referenced license terms, warranty disclaimers and copyright notices are available for download. LG Electronics will also provide open source code to you on CD-ROM for a charge covering the cost of performing such distribution (such as the cost of media, shipping and handling) upon e-mail request to opensource@lge.com. This offer is valid for three (3) years from the date on which you purchased the product.



For Customer Support/Service, please call:

1-888-865-3026

www.lg.com/us/business

Pro:Idiom is a registered trademark of Zenith Electronics LLC. Pro:Centric, Smart Share, and the "LG" logo are registered trademarks of LG Electronics Inc. DLNA Certified is a registered trademark of Digital Living Network Alliance. Intel is a registered trademark of Intel Corporation in the U.S. and/or other countries. Wi-Fi Direct and Miracast are registered trademarks of Wi-Fi Alliance. All other trademarks or registered trademarks are the property of their respective owners.