

77EU960H  
65EU960H  
55EU960H

---

## Pro:Centric® SMART UHD OLED Hospitality TV

### EU960H

LG perfects cutting edge Hospitality management with LG Pro:Centric® SMART technology while dazzling guests with Ultra HD resolution in a blade-slim OLED TV that delivers stunning colors, infinite contrast and deepest black. Support for the Pro:Centric® Direct Application and integrated Pro:Idiom® DRM solution enables hoteliers to provide a personalized guest television experience while protecting premium studio content across the entire property.



# Pro:Centric® SMART UHD OLED Hospitality TV

EU960H

## Stunning LG OLED Display

### Perfect Black. Intense Color

LG OLED TVs provide rich colors and have a natural, vibrant beauty. Equipped with over eight million of self-lightning pixels operating individually, these products exemplify effective use of "Perfect Black."

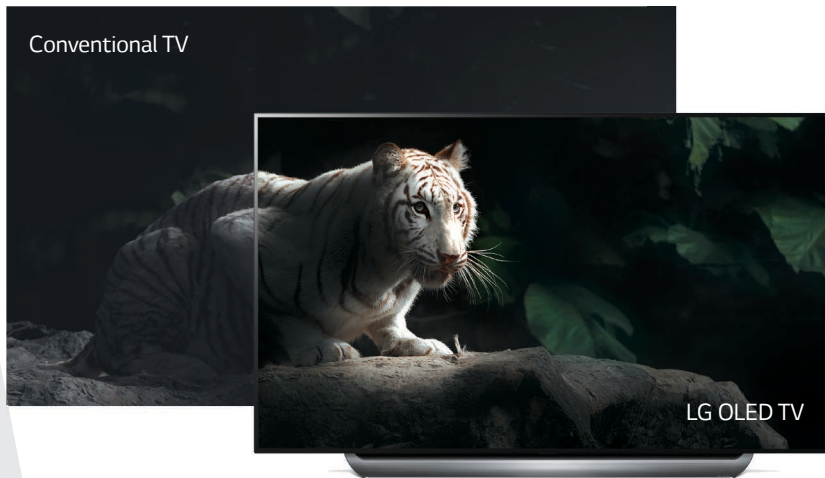

### 4K Cinema HDR

Now, a unique cinematic experience is available in guest rooms with Dolby Vision™ and advanced High Dynamic Range (HDR).



## Pro:Centric® SMART UHD OLED Hospitality TV

EU960H

### LG Cinema on Artistic Glass

#### Cinematic Sound

Dolby Atmos™ creates a dynamic surround sound experience even when space is limited, facilitating discernment of every detail of the movement in a scene. With Dolby Vision, this series provides a truly unique cinematic experience.



#### Picture-on-Glass Design

Furnished with sleek design, the product takes its artistic aspect to the next level. Typical bezel and thick stand elements have been eliminated, and the refined design intensifies the viewing experience.



# Pro:Centric® SMART UHD OLED Hospitality TV EU960H

## Pro:Centric SMART Application Platform

### Pro:Centric Hotel Management Solution

The EU960H is the latest in the line of Pro:Centric TVs that provide a unique and dedicated hotel applications hosting platform for LG's system integrators' interactive applications, enabling delivery for a wide range of custom applications tailored to both hotel management and guest needs. LG Pro:Centric SMART offers extended customizable tools: HTML5, Java and Flash. Using these tools, partners can optimize the TVs by editing and developing their own enhanced service design to increase the visual impact on guests.

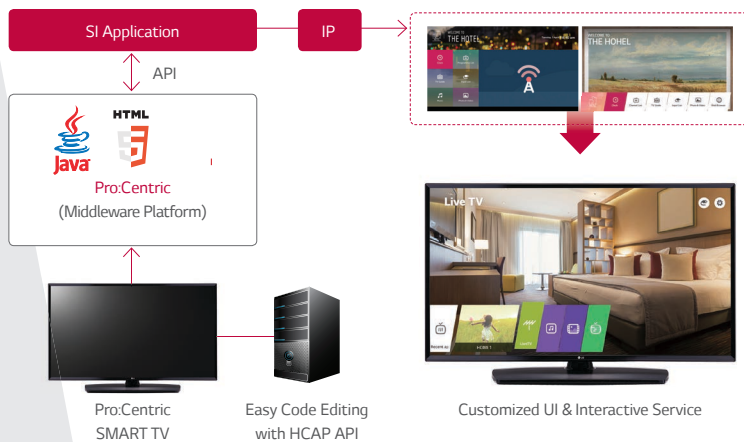

\* Customized UI may look different.

### Pro:Centric Direct Solution

Pro:Centric Direct is a hotel content management system that supports simple editing tools and provides various solutions such as smart apps and remote management over RF or IP. A browser-based Admin Client GUI enables users to easily edit the guest user interface, provide customized service and manage all TVs efficiently.

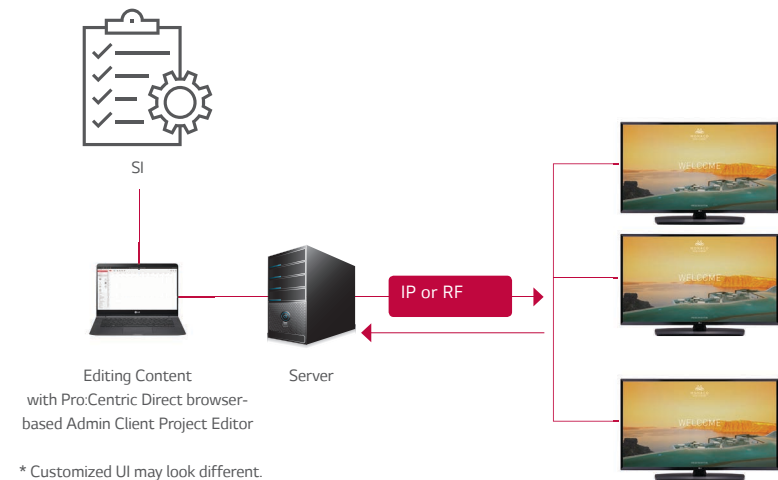

\* Customized UI may look different.

\* Even if you are using an LG PCS400R Pro:Centric server configured for RF output, Pro:Centric Direct interactive features are available with IP connectivity.

## Dimensions

77"

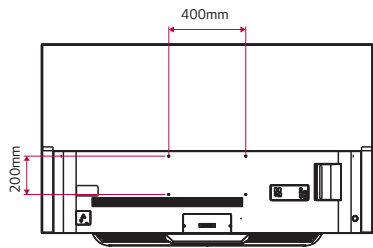
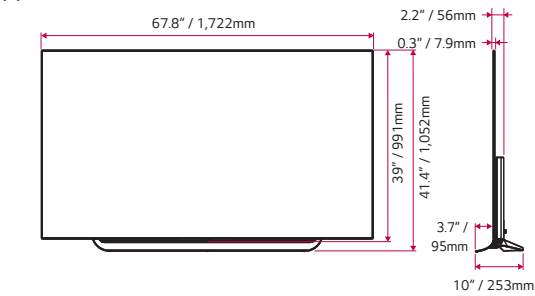

65"

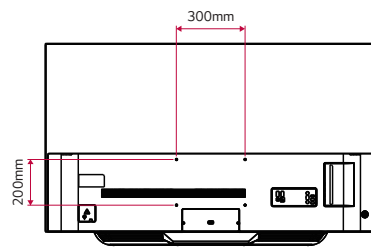
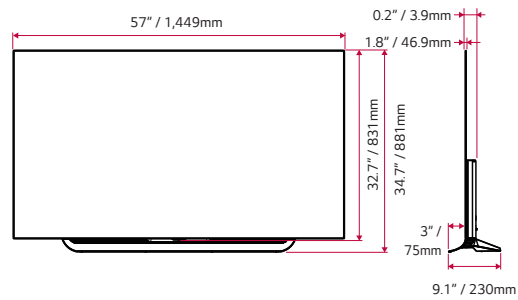

55"

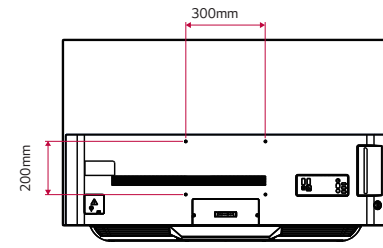
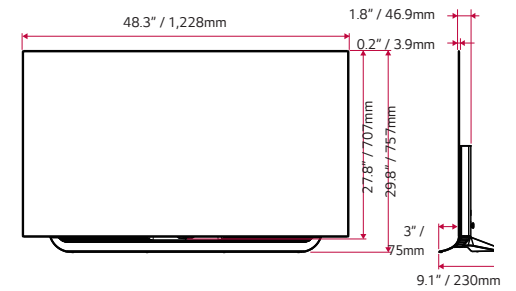

## Connectivity

77"

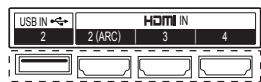
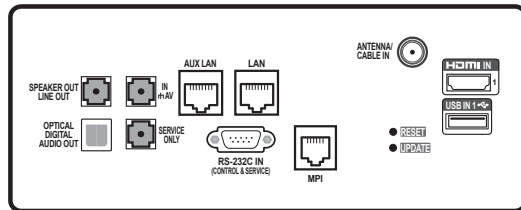

65"

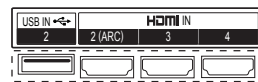
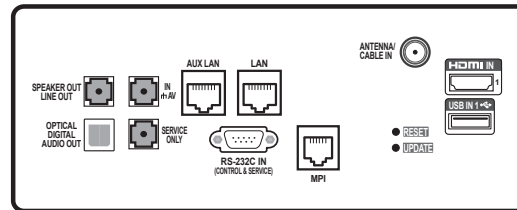

55"

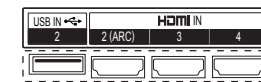
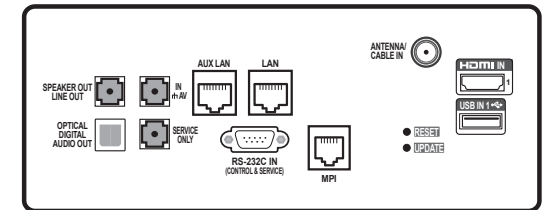

\* Dimensions & Jack Panels (Read/Side) may differ from the above image, so please reach LG salesteam to ensure before order.

# Specifications

	77EU960H	65EU960H	55EU960H	
PANEL	Screen Size	77"	65"	55"
	Backlight Type	OLED	OLED	OLED
	Resolution	3,840 x 2,160 (4K UHD)	3,840 x 2,160 (4K UHD)	3,840 x 2,160 (4K UHD)
	Brightness (nits)	500	500	500
	Dynamic Contrast Ratio (Dynamic MCI (Hz))	Infinite	Infinite	Infinite
	Static (Panel) Contrast Ratio	150,000	150,000	150,000
	Viewing Angle Degree	120	120	120
	Response Time (G to G, ms)	3	3	3
	Bezel Color	Back Top: Brilliant Silver Back Bottom: Iron Gray	Back Top: Brilliant Silver Back Bottom: Iron Gray	Back Top: Brilliant Silver Back Bottom: Iron Gray
	Stand Color	Front: Medio Titan, Back: Iron Gray	Front: Medio Titan, Back: Iron Gray	Front: Medio Titan, Back: Iron Gray
BROADCASTING SYSTEM	Analog	Yes (NTSC)	Yes (NTSC)	Yes (NTSC)
	Digital	Yes (ATSC)	Yes (ATSC)	Yes (ATSC)
VIDEO	XD Engine	Yes	Yes	Yes
	Aspect Ratio	5 Modes (16:9 / Original / 4:3 / Vertical Zoom / All-Direction Zoom)		
	HDR 10 / HDR Dolby Vision	Yes / Yes	Yes / Yes	Yes / Yes
AUDIO	Audio Output	10W + 10W	10W + 10W	10W + 10W
	Speaker System	2.0 ch	2.0 ch	2.0 ch
	Sound Mode	6 Modes (Standard / Cinema / Clear Voice III / Sports / Music / Game)		
	Clear Voice	Yes (Clear Voice III)	Yes (Clear Voice III)	Yes (Clear Voice III)
	Dolby Atmos	Yes	Yes	Yes
	Adaptive Sound Control	Yes	Yes	Yes
HOSPITALITY SOLUTION	One Touch Sound Tuning	Yes	Yes	Yes
	Pro:Centric SMART	Pro:Centric (SMART, V, Direct)	Pro:Centric (SMART, V, Direct)	Pro:Centric (SMART, V, Direct)
	Data Streaming (IP & RF)	Yes	Yes	Yes
	RF (1/2Tuner)	Yes (1 Tuner)	Yes (1 Tuner)	Yes (1 Tuner)
	HCAP (GEM / FLASH / HTML)	GEM / Flash / HTML5	GEM / Flash / HTML5	GEM / Flash / HTML5
	DRM	ProIdiom (S/W Type)	ProIdiom (S/W Type)	ProIdiom (S/W Type)
	Instant ON	Yes	Yes	Yes
Picture Mode	Vivid / Standard / APS / Cinema/ Sports / Game /HDR Effect/ Expert(Bright Room) / Expert(Dark Room)			
SMART FEATURES	WebOS 4.0, Commercial Smart Home, Gallery Mode, DeepThinQ (LG NLP), Web Browser, Pre-loaded Apps, SDP Server Compatibility, Magic Remote Compatibility, SoftAP, Wi-Fi (Built-in Type), Screen Share (Miracast), Smart Share (DLNA), Bluetooth Audio Playback, LG Sound Sync/Bluetooth, Mobile Connection Overlay, Music Player			
FUNCTIONS	EZ-Manager (Setup Wizard), USB Cloning, Wake on LAN, SNMP, Remote Diagnostics, SI Compatible, HTNG-CEC (1.4), HDMI-CEC (1.4), IR Out (MPI Jack/RS232C), Multi IR Code, Auto Off / Sleep Timer, Smart Energy Saving, Motion Eye Care			
HOSPITALITY FEATURES	Installer Menu, Welcome Screen, Insert Image, External Speaker Out, Instant ON, V-Lan Tag, Alarm, 360 Viewer, Kensington Lock			
JACK INTERFACE	Set Side	HDMI In 2.0 (3), USB 2.0	HDMI In 2.0 (3), USB 2.0	HDMI In 2.0 (3), USB 2.0
	Set Rear	RF In, AV In, Digital Audio Out (Optical), USB 2.0, RS-232C (Control), RJ45 (2), External Speaker Out, MPI Port, Service (Phone Jack Type), HDMI In 2.0		
PHYSICAL	VESA Compatible	400 x 200 mm	300 x 200 mm	300 x 200 mm
	W x H x D / Weight (with stand)	1,722 x 1,052 x 253 mm / 36.5kg   67.8" x 41.4" x 10" / 80.5 lbs	1,449 x 881 x 230 mm / 25.4kg   57" x 34.7" x 9.1" / 56 lbs	1,228 x 757 x 230 mm / 19.1kg   48.3" x 29.8" x 9.1" / 42.1 lbs
	W x H x D / Weight (without stand)	1,722 x 991 x 56 mm / 29.9kg   67.8" x 39" x 2.2" / 65.9 lbs	1,449 x 831 x 46.9 mm / 21kg   57" x 32.7" x 1.8" / 46.3 lbs	1,228 x 707 x 46.9 mm / 16.3kg   48.3" x 27.8" x 1.8" / 35.9 lbs
	W x H x D / Weight (Packing)	1,895 x 1,130 x 285 mm / 49.5kg   74.6" x 44.5" x 11.2" / 109.1 lbs	1,600 x 970 x 207 mm / 33kg   63" x 38.2" x 8.1" / 72.8 lbs	1,345 x 810 x 207 mm / 24.4kg   53" x 31.9" x 8.1" / 53.8 lbs
ELECTRICAL	Voltage (V), Frequency (Hz)	100 - 240V, 50/60Hz	100 - 240V, 50/60Hz	100 - 240V, 50/60Hz
	Power Max (W)	714 W	430 W	389 W
	Power Typical (W)	665 W	384 W	336 W
	Power Stand-by (W)	0.5W↓	0.5W↓	0.5W↓
OTHER	Certifications/Approvals	UL, FCC, RoHS, NOM, Dolby Vision		
	Accessories	Magic Remote, Power Cord 1.8 meter		
	Warranty	2 Year Limited Warranty (Parts and Labor)		
	UPC	719192623279	719192623002	719192623019

\* Specifications are subject to change without notice, so please verify with your LG sales team before ordering.

<http://www.lg.com/us/business/commercial-display>  
<http://www.twitter.com/LGCommDisplays>  
<http://www.facebook.com/LGcommercialdisplays>  
<http://www.linkedin.com/company/lg-commercial-displays-usa>  
<http://www.youtube.com/lgcommercialdisplayusa>

800-228-1236 Hospitality Sales  
 LG may make changes to specifications and product descriptions without notice.  
 © Copyright 2018 LG Electronics USA, Inc. All rights reserved. LG and the LG logo are registered trademarks of LG Corp.  
 Pro:Centric and the "Pro:Centric" logo are registered trademarks of LG Electronics Inc. Pro:Idiom is a registered trademark of Zenith Electronics LLC. SPEC\_EU960H\_081854\_PR

