



**32LD650H 37LD650H 42LD650H 47LD650H 55LD650H  
32LD655H 37LD655H 42LD655H  
32LG710H 37LG710H 42LG710H**

**Lodging Guest Interactive Pro:Centric™ TVs**

---

## **Commercial Mode Setup Guide**

Note: Selected features shown in this guide may not be available on all models.

### **EXPERIENCED INSTALLER**

Commercial Mode Setup  
pages 13–14

Cloning Information  
pages 28–33

*b*-LAN™ Setup & Overview  
page 40

For Customer Support/Service, please call:

**1-888-865-3026**

The latest product information and documentation is available online at:

**www.LGolutions.com/products**

MODEL and SERIAL NUMBER

The model and serial numbers of this TV are located on the back of the cabinet. For future reference, LG suggests that you record those numbers here:

Model No. \_\_\_\_\_ Serial No. \_\_\_\_\_



**WARNING**  
**RISK OF ELECTRIC SHOCK**  
**DO NOT OPEN**



**WARNING:**

TO REDUCE THE RISK OF ELECTRIC SHOCK DO NOT REMOVE COVER (OR BACK). NO USER-SERVICEABLE PARTS INSIDE. REFER TO QUALIFIED SERVICE PERSONNEL.



The lightning flash with arrowhead symbol, within an equilateral triangle, is intended to alert the user to the presence of uninsulated “dangerous voltage” within the product’s enclosure that may be of sufficient magnitude to constitute a risk of electric shock to persons.



The exclamation point within an equilateral triangle is intended to alert the user to the presence of important operating and maintenance (servicing) instructions in the literature accompanying the appliance.

**WARNING:**

TO PREVENT FIRE OR SHOCK HAZARDS, DO NOT EXPOSE THIS PRODUCT TO RAIN OR MOISTURE.

**Power Cord Polarization:**

This product is equipped with a 3-wire grounding-type alternating current power plug. This plug will fit into the power outlet only one way. This is a safety feature. If you are unable to insert the plug fully into the outlet, contact your electrician to replace your obsolete outlet. Do not defeat the safety purpose of the 3-wire grounding-type plug.

**NOTE TO CABLE/TV INSTALLER:**

This reminder is provided to call the cable TV system installer’s attention to Article 820-40 of the National Electric Code (U.S.A.). The code provides guidelines for proper grounding and, in particular, specifies that the cable ground shall be connected to the grounding system of the building, as close to the point of the cable entry as practical.

**REGULATORY INFORMATION:**

This equipment has been tested and found to comply with the limits for a Class B digital device, pursuant to Part 15 of the FCC Rules. These limits are designed to provide reasonable protection against harmful interference when the equipment is operated in a residential installation. This equipment generates, uses and can radiate radio frequency energy and, if not installed and used in accordance with the instruction manual, may cause harmful interference to radio communications. However, there is no guarantee that interference will not occur in a particular installation. If this equipment does cause harmful interference to radio or television reception, which can be determined by turning the equipment off and on, the user is encouraged to try to correct the interference by one or more of the following measures:

- Reorient or relocate the receiving antenna.
- Increase the separation between the equipment and receiver.
- Connect the equipment to an outlet on a circuit different from that to which the receiver is connected.
- Consult the dealer or an experienced radio/TV technician for help.

**CAUTION:**

Do not attempt to modify this product in any way without written authorization from LG Electronics U.S.A., Inc. Unauthorized modification could void the user’s authority to operate this product.

**COMPLIANCE:**

The responsible party for this product’s compliance is: LG Electronics U.S.A., Inc.  
1000 Sylvan Avenue, Englewood Cliffs, NJ 07632, USA • Phone: 1-201-816-2000

Marketed and Distributed in the United States by LG Electronics U.S.A., Inc.  
1000 Sylvan Avenue, Englewood Cliffs, NJ 07632

# IMPORTANT SAFETY INSTRUCTIONS

---

1. Read these instructions.
2. Keep these instructions.
3. Heed all warnings.
4. Follow all instructions.
5. Do not use this apparatus near water.
6. Clean only with dry cloth.
7. Do not block any ventilation openings. Install in accordance with the manufacturer's instructions.
8. Do not install near any heat sources, such as radiators, heat registers, stoves, or other apparatus (including amplifiers) that produce heat.
9. Do not defeat the safety purpose of the polarized or grounding-type plug. A polarized plug has two blades with one wider than the other. A grounding-type plug has two blades and a third grounding prong. The wide blade or the third prong are provided for your safety. If the provided plug does not fit into your outlet, consult an electrician for replacement of the obsolete outlet.
10. Protect the power cord from being walked on or pinched, particularly at plugs, convenience receptacles, and the point where it exits from the apparatus.
11. Only use attachments/accessories specified by the manufacturer.
12. Use only with the cart, stand, tripod, bracket, or table specified by the manufacturer or sold with the apparatus. When a cart is used, use caution when moving the cart/apparatus combination in order to avoid injury from tip-over.
13. Unplug this apparatus during lightning storms or when unused for long periods of time.
14. Refer all servicing to qualified service personnel. Servicing is required when the apparatus has been damaged in any way, such as power-supply cord or plug is damaged, liquid has been spilled or objects have fallen into the apparatus, the apparatus has been exposed to rain or moisture, does not operate normally, or has been dropped.
15. Never touch this apparatus or antenna during a thunder or lightning storm.
16. When mounting a TV on the wall, make sure not to install the TV by the hanging power and signal cables on the back of the TV.
17. Do not allow an impact shock or any objects to fall into the product, and do not drop objects onto the screen.
18. **Power Cord**  
**Caution: It is recommended that appliances be placed upon a dedicated circuit; that is, a single outlet circuit which powers only that appliance and has no additional outlets or branch circuits. Check the specification page of the Owner's Manual to be certain.**  
Periodically examine the cord of your appliance, and if its appearance indicates damage or deterioration, unplug it, discontinue use of the appliance, and have the cord replaced with an exact replacement part by an authorized servicer. Protect the power cord from physical or mechanical abuse, such as twisting, kinking, or pinching or being closed in a door or walked upon. Pay particular attention to plugs, wall outlets, and the point where the cord exits the appliance.  
Do not use a damaged or loose power cord. Be sure to grasp the plug when unplugging the power cord. Do not pull on the power cord to unplug the TV.
19. **Overloading**  
Do not connect too many appliances to the same AC power outlet as this could result in fire or electric shock. Do not overload wall outlets. Overloaded wall outlets, loose or damaged wall outlets, extension cords, frayed power cords, or damaged or cracked wire insulation are dangerous. Any of these conditions could result in fire or electric shock.
20. **Outdoor Use/Wet Location**  
 **Warning: To reduce the risk of fire or electrical shock, do not expose this product to rain, moisture or other liquids.**  
Do not touch the TV with wet hands. Do not install this product near flammable objects such as gasoline or candles or expose the TV to direct air conditioning.  
Do not expose to dripping or splashing and do not place objects filled with liquids, such as vases, cups, etc., on or over the apparatus (e.g., on shelves above the unit).



(Continued on next page)

# IMPORTANT SAFETY INSTRUCTIONS

(Continued from previous page)

## 21. Grounding

Ensure that you connect the earth ground wire to prevent possible electric shock (i.e., a TV with a three-prong grounded AC plug must be connected to a three-prong grounded AC outlet). If grounding methods are not possible, have a qualified electrician install a separate circuit breaker. Do not try to ground the unit by connecting it to telephone wires, lightning rods, or gas pipes.

## 22. Disconnect Device

The mains plug is the disconnecting device. The plug must remain readily operable.

As long as this unit is connected to the AC wall outlet, it is not disconnected from the AC power source even if you turn off this unit by SWITCH.

## 23. Outdoor Antenna Grounding

If an outside antenna or cable system is connected to the product, follow the precautions below.

An outdoor antenna system should not be located in the vicinity of overhead power lines or other electric light or power circuits or where it can come into contact with such power lines or circuits as death or serious injury can occur.

Be sure the antenna system is grounded so as to provide some protection against voltage surges and built-up static charges.

Article 810 of the National Electrical Code (NEC) in the U.S.A. provides information with respect to proper grounding of the mast and supporting structure, grounding of the lead-in wire to an antenna-discharge unit, size of grounding conductors, location of antenna-discharge unit, connection to grounding electrodes, and requirements for the grounding electrode.

## Antenna Grounding According to NEC, ANSI/NFPA 70

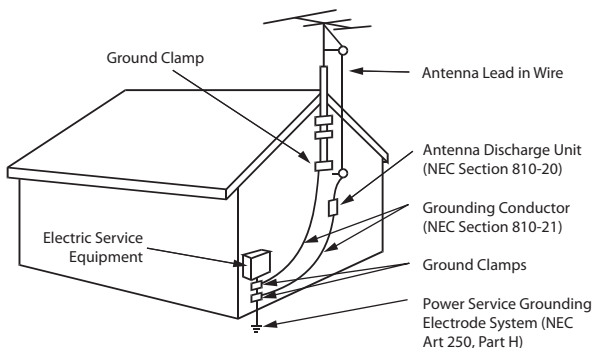

## 24. Cleaning

When cleaning, unplug the power cord and rub gently with a soft cloth to prevent scratching. Do not spray water or other liquids directly on the TV as electric shock may occur. Do not clean with chemicals such as alcohol, thinners or benzene.

## 25. Transporting Product

Make sure the product is turned Off and unplugged and that all cables have been removed. It may take two or more people to carry larger TVs. Do not press against or put stress on the front panel of the TV.

## 26. Ventilation

Install the TV where there is proper ventilation. Do not install in a confined space such as a bookcase. Do not cover the product with cloth or other materials (e.g., plastic) while it is plugged in. Do not install in excessively dusty places.

27. Do not touch the ventilation openings, as they may become hot while the TV is operating.

28. If you smell smoke or other odors coming from the TV or hear strange sounds, unplug the power cord, and contact an authorized service center.

29. Do not press strongly on the panel with a hand or sharp object (e.g., a nail, pencil, or pen) or make a scratch on it.

30. Keep the product away from direct sunlight.

# Table of Contents

---

Safety Warnings . . . . .	2	Learning / Teaching a Master TV Setup using a TLL-1100A Clone Programmer . . . . .	30–31
Important Safety Instructions . . . . .	3–4	Learning / Teaching a Master TV Setup using an LT2002 Clone Programmer . . . . .	32–33
Table of Contents . . . . .	5	Remote Jack Pack / TV Connections & Setup . . . . .	34
Setup Checklist / Overview . . . . .	6	Reference: Upgrading TV/PTC Software with a USB Memory Device . . . . .	35
Pro:Centric TV Interactive Menu Features . . . . .	7	Reference: Power Consumption Settings . . . . .	36–37
LD650H/LD655H Rear Jack Panel . . . . .	8	32/37/42LD650H/LD655H . . . . .	36
LG710H Rear Jack Panel . . . . .	9	32/37/42LG710H . . . . .	37
Side Connections Panel / RF Antenna Connection . . . . .	10	Reference: TV Camport Auto Sense Operation . . . . .	38
Installer Overview . . . . .	11	Reference: TV Aux Input Configuration . . . . .	39
Installer Remote Control Typical Key Functions . . . . .	12	Reference: b-LAN Setup & Overview . . . . .	40
Commercial Mode Setup for Master TV . . . . .	13–14	Reference: RJP Model List and Input Auto-sensing Hierarchy . . . . .	41
Installer Menu . . . . .	15–21	Troubleshooting . . . . .	42–45
TV Setup Menus Overview . . . . .	22	General Troubleshooting . . . . .	42
Adding Channel Icons / Custom Channel Labels (2-5-4 + MENU Mode) . . . . .	23	Troubleshooting Flowchart . . . . .	43
FTG Mode of Operation . . . . .	24–27	Commercial Mode Check / FTG Operating Troubleshooting . . . . .	44
FTG Setup Overview . . . . .	24	Clone Programmer Troubleshooting . . . . .	45
Determining the TV Operating Mode / FTG Channel Map Configuration Utility Overview . . . . .	25	Glossary of Terms . . . . .	46
FTG Channel Map Configuration Utility / FTG Channel Map Editor Overview . . . . .	26	Document Revision History / Notes . . . . .	47
FTG Installer Menu Configuration Utility Overview . . . . .	27	Back Cover . . . . .	48
Cloning Overview / Clonable Menu Features . . . . .	28		
Cloning Procedures . . . . .	29–33		
Learning / Teaching a Master TV Setup using a USB Memory Device . . . . .	29		

---

For Customer Support/Service, please call:

**1-888-865-3026**

[www.LGolutions.com](http://www.LGolutions.com)

Note: Design and specifications subject to change without prior notice.

# Setup Checklist / Overview

---

## Setup Checklist

### Installation and Setup Checklist

- \_\_\_ Unpack TV and all accessories.
- \_\_\_ Install batteries in remote control.
- \_\_\_ Install TV on VESA mount or stand.  
**Note:** It may be advisable to make all cable connections before installing on VESA mount or stand, as appropriate.

### Hardware Connections

- \_\_\_ Install any additional hardware as appropriate to your institution, LAN, etc.

### Cable Connections

- \_\_\_ Make all connections to rear jack panel and RF antenna on MPI/PPV card.
- \_\_\_ Make all connections to signal, interactive resources, and Aux sources, as appropriate.

### Commercial Mode Setup

- \_\_\_ Complete Commercial Mode Setup (configure all relevant Installer Menu items as required of your institution and configure display features for the end user).

### Software Installation

- \_\_\_ Install or configure any software, as applicable, for example, PPV, etc.

---

## Commercial Mode Setup Overview

This document describes how to set up LD650H/LD655H/LG710H Pro:Centric™ TVs for Commercial Mode either while in the Embedded *b*-LAN™ (EBL) module's Pass-through Mode or its Free-To-Guest (FTG) Mode.

**Note:** The *b*-LAN module is internal to the TV and allows the hotel/institution head end equipment to communicate with the TV for configuration and control. See Reference section, "*b*-LAN Setup & Overview," for further information. The *b*-LAN module also comprises the data tuner required for Pro:Centric operation (see next page).

### Pass-through Mode

This mode allows you to configure a Master TV Setup for cloning purposes as well as external VOD/PPV control. Use the Installer Remote to configure Installer Menu items as required for TV operation and set up TV features (Channel, Picture, Audio, etc.). See pages 13 to 14 for detailed information.

### FTG Mode

This mode enables Pro:Idiom® decryption and also allows logical channel mapping of physical channels to remove the need for dash tuning. FTG Configuration Application software is used to configure and/or edit Channel Map and Installer Menu settings. See pages 24 to 27 for further information on FTG Mode and local configuration using a PC with the FTG Configuration Application. Since these TV models are equipped with the EBL Module, they can also be broadcast configured in FTG Mode by a Free-To-Guest Management Appliance (FMA) head end device. Refer to the **Free-To-Guest (FTG) Configuration Application** manual and/or the Installation & Setup manual for the FMA device.

# Pro:Centric TV Interactive Menu Features

Channel Guide  
Information  
Remote Help  
Watch TV

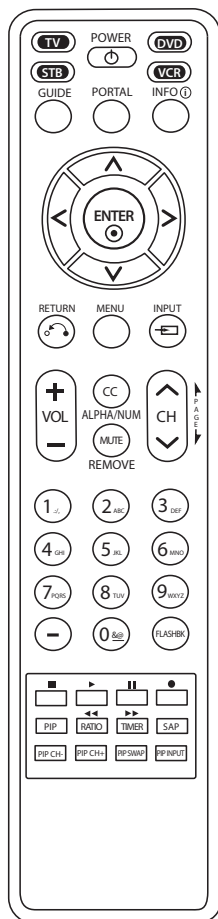

**Important: Pro:Centric operation requires that Installer Menu item 119 DATA CHANNEL be set appropriately and that the TV be in PPV or FTG Mode.**

The interactive Pro:Centric TV enables guests—from the comfort of their hotel rooms—to view and select from a complete listing of hotel services and amenities. The Pro:Centric TV is connected to the hotel's billing computer, and service/amenities charges are billed at the time of order.

Interactive amenities may include:

- Hotel information, news, and events
- Directory services (tourist attractions, restaurants, etc.)
- Reservation services (business meetings, fitness, spa, etc.)
- Weather and traffic information
- Shopping services (delivery to guest room)
- Room service (menu ordering, memo service, morning wake up call, laundry, etc.)
- Ticketing services
- Check-out service (in the guest room)
- Gaming services
- E-mail resources/account access

Use the Installer Remote to operate both interactive menus and regular TV features. Press **PORTAL** on the Installer Remote to access the interactive menus.

## Channel Guide

Shows available TV programs. Indicates the channel and the program start and finish times and also identifies the TV network.

## Information

Typically displays hotel information, for example, photos of guest rooms, dining rooms, business centers, fitness and pool facilities, etc. Information may also include resources, such as local school programs, run in cooperation with the hotel.

## Remote Help

Provides help for navigating the interactive menus.

## Watch TV

Removes the interactive menu from the screen and returns to the previously tuned TV channel.



# LD650H/LD655H Rear Jack Panel

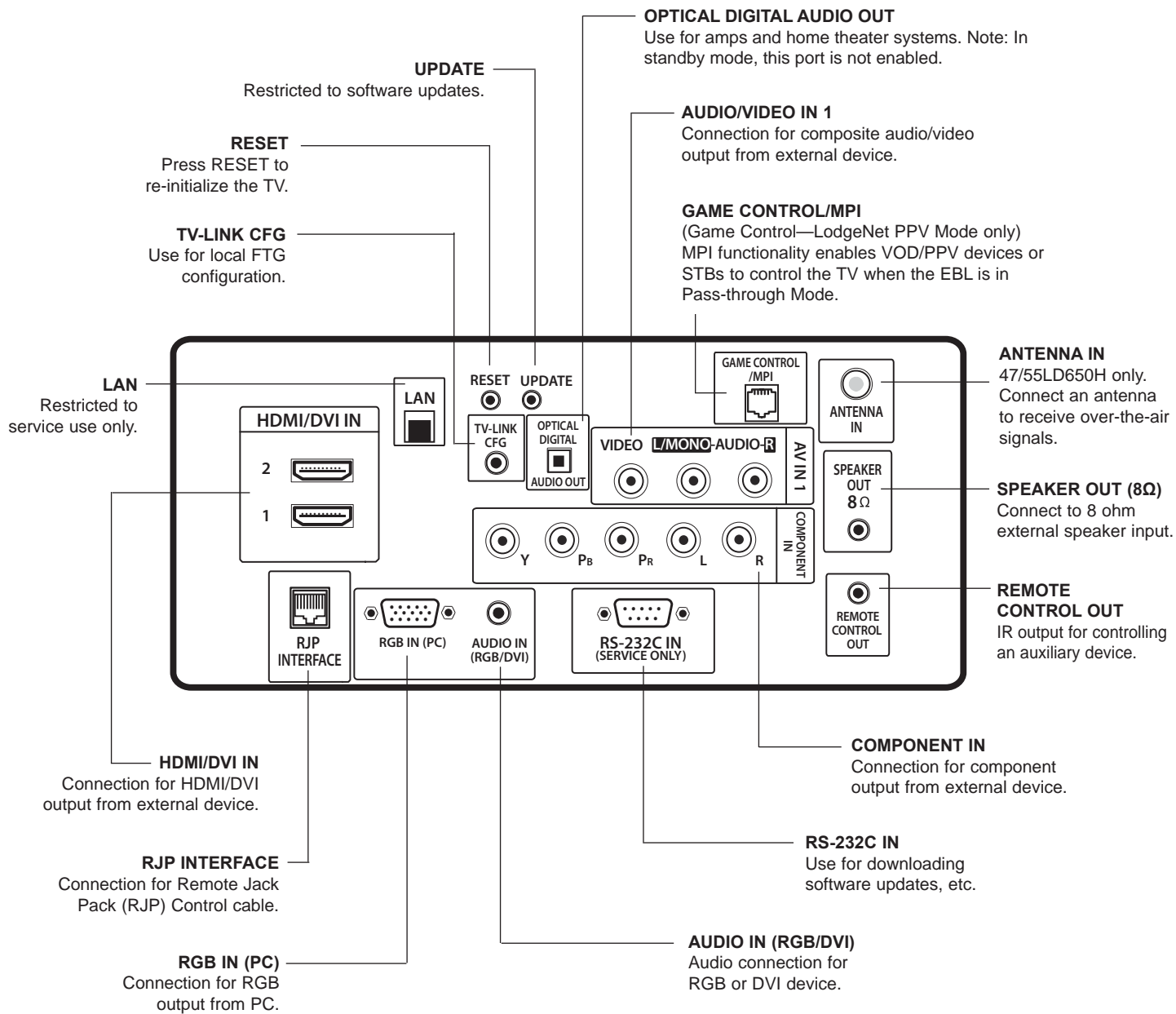



# LG710H Rear Jack Panel

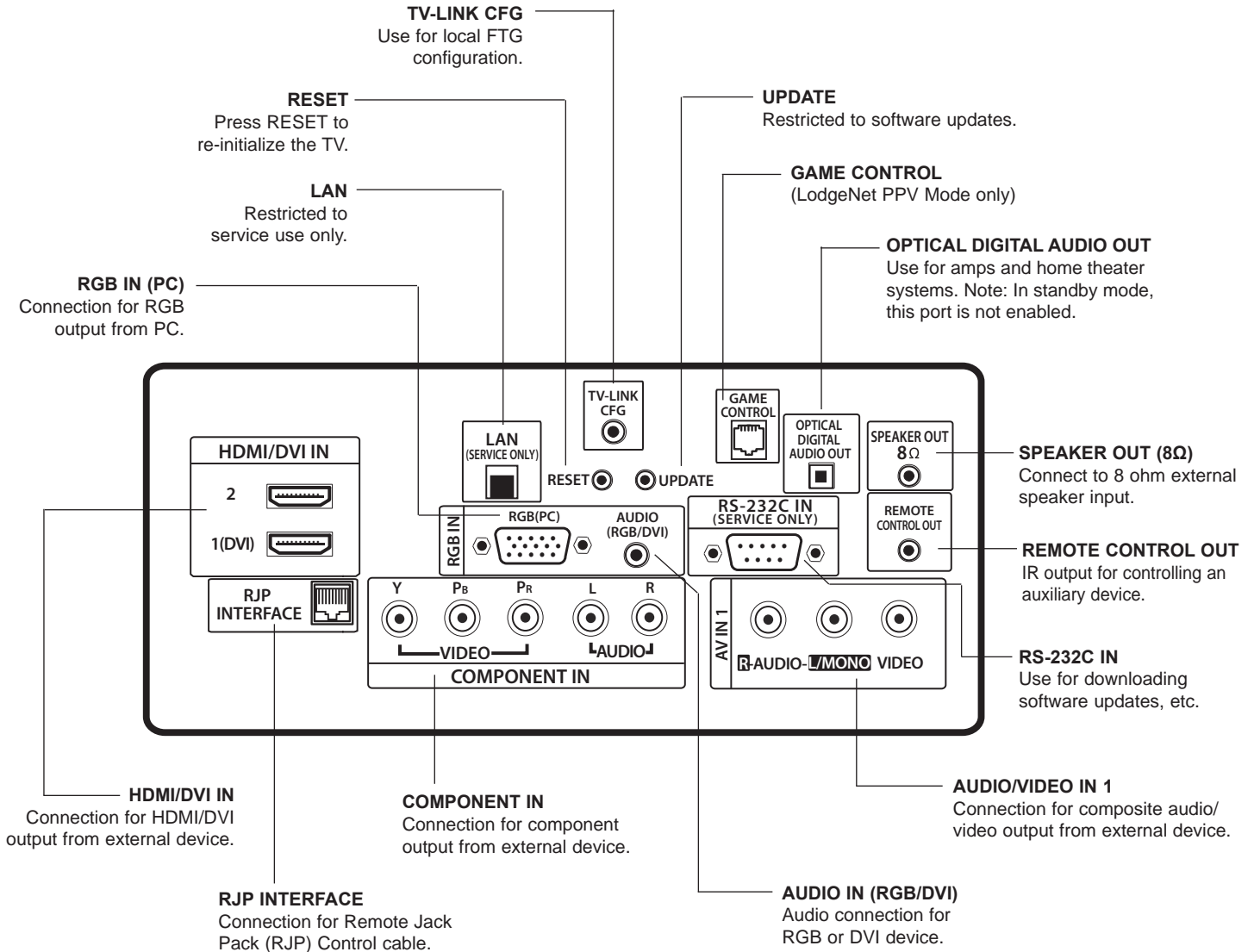

# Side Connections Panel / RF Antenna Connection

## Side Connections Panel

(All LD650H/LD655H/LG710H TVs)

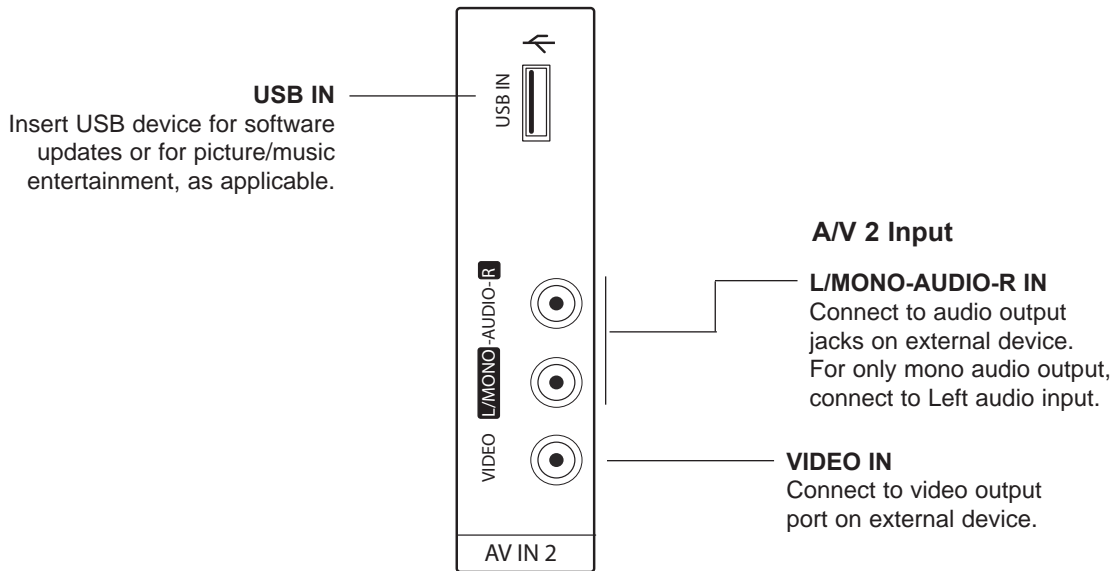

## RF Antenna Connection

(32/37/42LD650H/LD655H/LG710H TVs)

**Note:** 47/55LD650H  
Antenna and MPI connections are on the rear jack panel (see page 8).

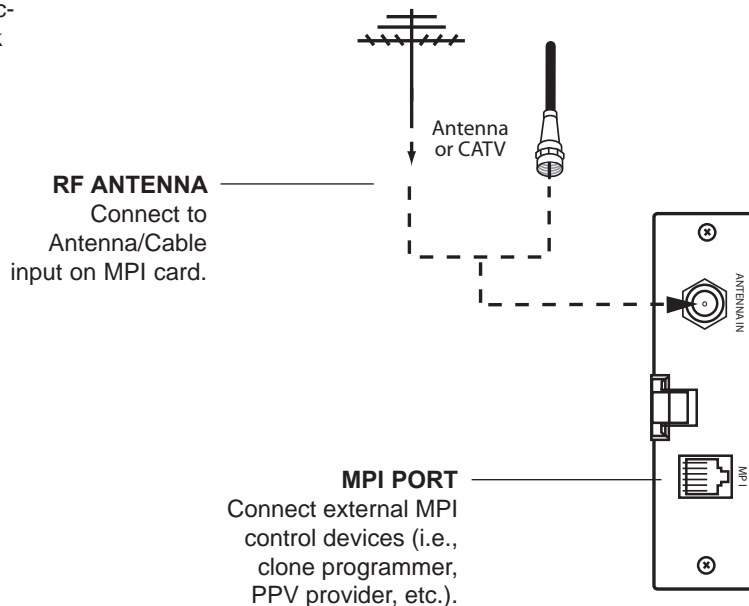

This is the Commercial Mode Setup Guide only.

## Installer Menu / Commercial Mode Setup

To set up a Master TV, you will need to know how to enter the TV Installer Menu and make changes to the default values as required. Similarly, to configure a single TV's Installer Menu settings in FTG Mode, you will need to know how to access and use the FTG Configuration Application utilities. If necessary, familiarize yourself with the Installer Menu and how to make and save changes. Refer to page 15 for information on accessing the Installer Menu in Pass-through Mode. Refer to page 24 for information on accessing the FTG Installer Menu Configuration Utility in the FTG Configuration Application. Pages 16 to 20 describe Installer Menu items in detail.

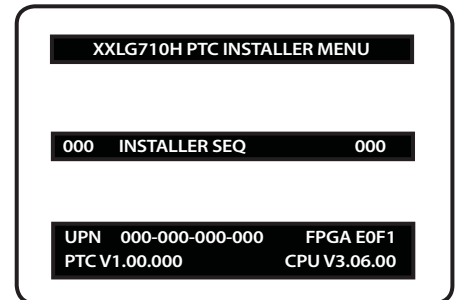

Typical Installer Menu

## Installer Remote

The LG Installer Remote is supplied with and dedicated to operate the TV. See next page for typical key functions in TV operating mode. Some DVD and VCR controls may be available for selected LG DVD/VCR products.

## Cloning

Cloning refers to the process of capturing a Master TV Setup and transferring it to a Target TV. The Master TV's clonable features need to be configured as part of the Commercial Mode Setup. This is a critical step. If the Master TV's clonable features—channel icons or labels, digital font options, etc.—are not set up correctly, the cloned TVs will all have problems. Pages 28 to 33 provide detailed information on cloning requirements and procedures.

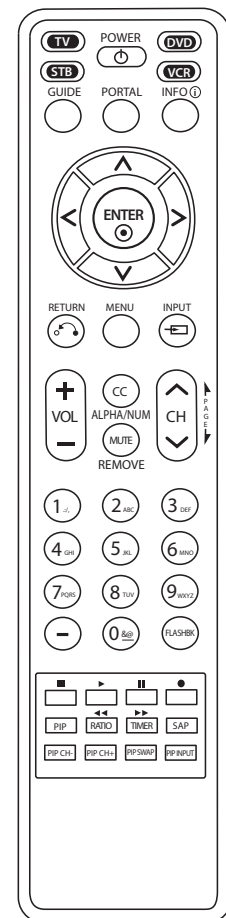
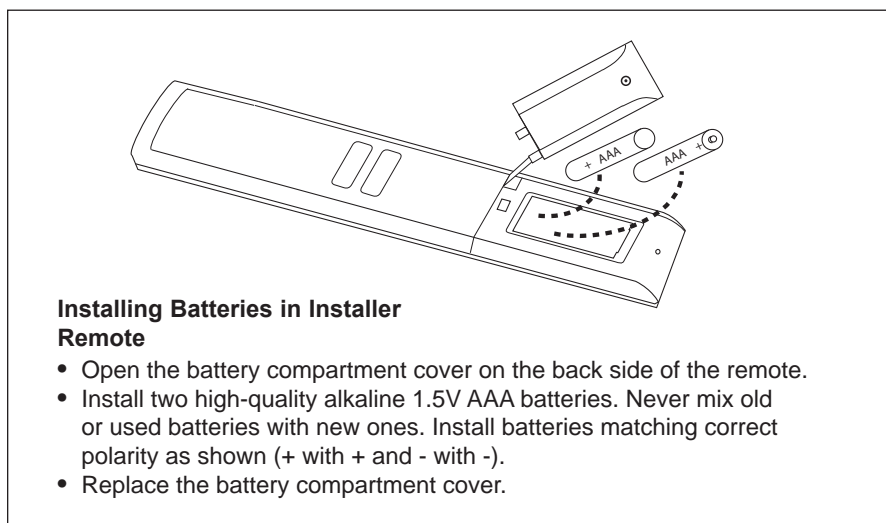

# Installer Remote Control Typical Key Functions

The LG Installer Remote illustrated below and throughout this document shows typical remote control functions and is provided for reference only. This Installer Remote may vary from the Installer Remote supplied with the TV.

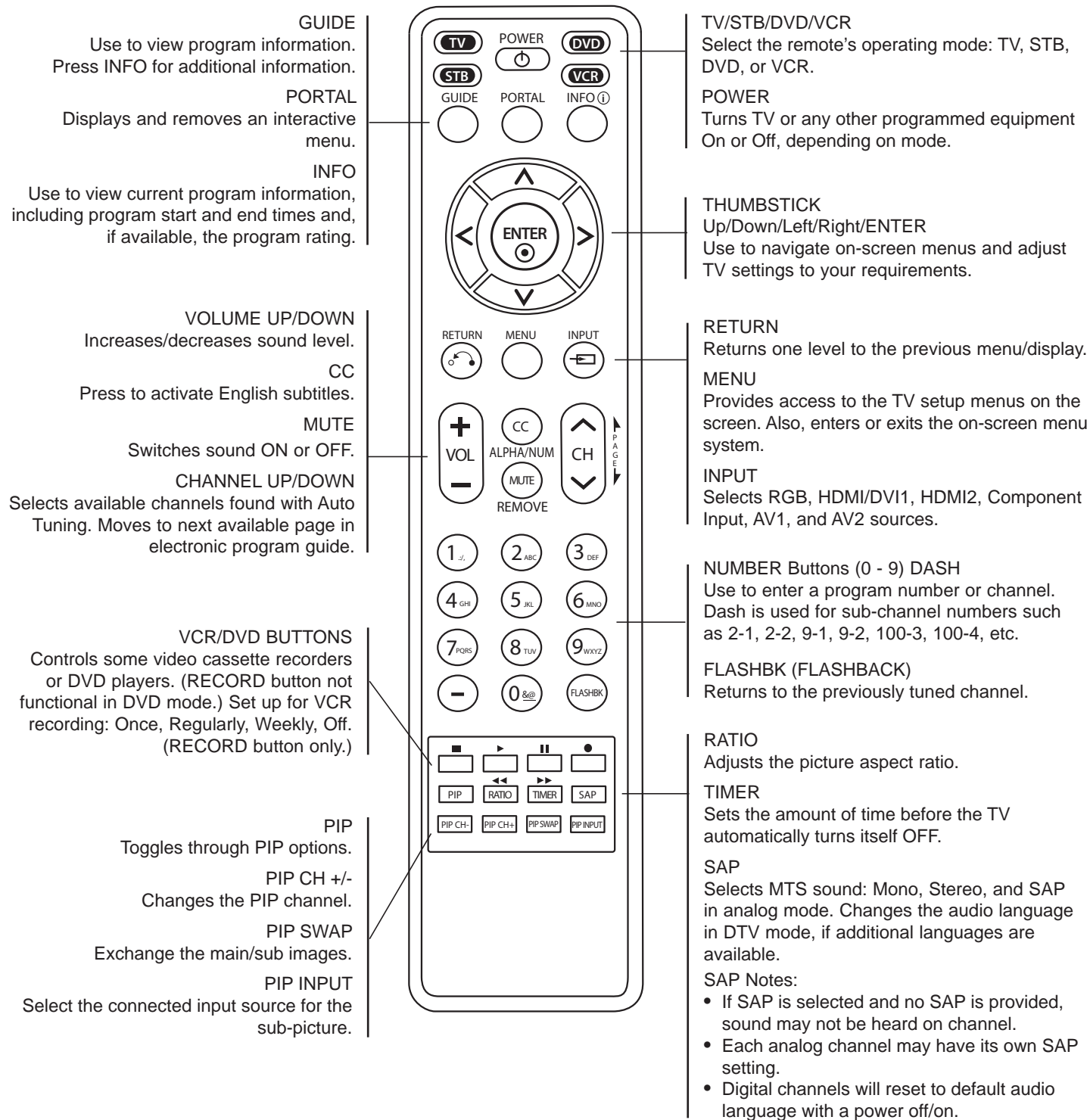

# Commercial Mode Setup for Master TV

This section describes how to set up a Master TV when the EBL is in Pass-through Mode.

**Note:** Disconnect all Aux inputs. Under certain conditions, Auto Tuning (Channel Search) is disabled if there is an Aux input active.

**Note:** Refer to “FTG Mode of Operation” on pages 24 to 27 for information on configuring/editing Channel Map and Installer Menu settings for an individual TV in FTG Mode.

## 1. Set Installer Menu items.

- a) Use the Installer Remote to enter the TV Installer Menu: Press **MENU** repeatedly until the on-screen menu locks up, and then press **9-8-7-6 + ENTER**. Refer to pages 15 to 20 for detailed information on Installer Menu items.
- b) Set Installer Menu item **117 FACT DEFAULT** to **001** and press **ENTER** on the Installer Remote.  
This clears all Installer Menu custom settings, channel labels/icons, etc. and reloads the factory default settings. The value will change back to 0 after the internal TV controller (Protocol Translator Card [PTC]) has been restored to factory default condition. This step ensures that the TV Channel Memory will be the active Channel List.
- c) Set Installer Menu item **003 BAND/AFC**, as appropriate.
  - Broadcast: Set to 000.
  - CATV: Set to 001 (default).
  - HRC: Set to 002.
  - IRC: Set to 003.
- d) Set any other Installer Menu items that affect your TV programming network to the required configuration. For example, enable/disable Aux sources, set a Start Channel, etc.
- e) After you have adjusted all required Installer Menu item settings, press **ENTER** on the Installer Remote to exit the menu and save your changes.

## 2. Set up TV features.

On-screen setup menus control the features of the TV (see page 22). Press **MENU** on the Installer Remote to access the setup menus, and then set Channel, Picture, Audio, Lock, Time, etc. options to the desired configurations. See also the Clonable Menu Features list on page 28.

**Note:** If desired, you can run Auto Tuning (see step 3) prior to completing this step.

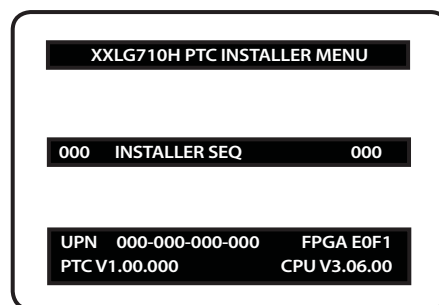

Typical TV Installer Menu

Note: The Installer Menu header will vary depending on the TV you are setting up.

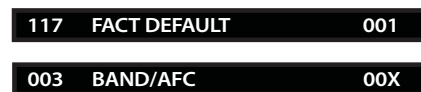

Adjust the settings for these Installer Menu items.

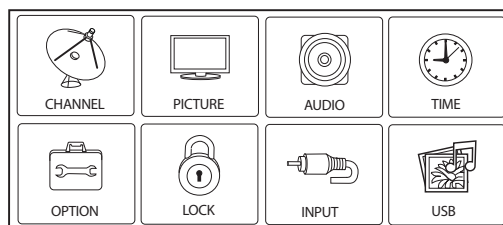

Set the TV features to the desired configuration for the end user.

(Continued on next page)

# Commercial Mode Setup for Master TV (Cont.)

(Continued from previous page)

### 3. Run Auto Tuning (Channel Search).

- a) Search for all available analog and digital channels: Go to the Channel Menu, select the **Auto Tuning** option, and follow the on-screen instructions.
- b) Use the **Channel Edit** option in the Channel Menu to edit the channel lineup, as necessary, to include free to guest channels only.
  - Add/delete channels per your system requirements. Note that physical channel numbers are used to identify virtual channels.
  - Use the **Channel Label** option in the Channel Menu to add familiar channel trademarks/logos such as ABC, CBS, NBC, etc. to the Channel-Time on-screen display. Identifiable labels (logos) should enable the end user to readily know what common networks are available. (You can add the channel labels in this step, or you can add channel logos or labels for channels without icons in step 5.)

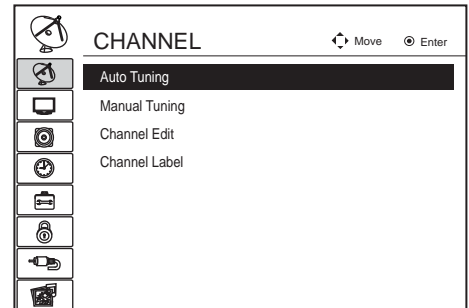

Run Auto Tuning, edit channels, and select familiar channel trademarks/logos using Channel Menu options.

### 4. Transfer the TV Setup to the internal TV Controller (PTC): 2-5-5 + MENU Mode

After the TV channel lineup has been edited and channel label icons added, enter the Installer Menu. Once in the Installer Menu, press **2-5-5 + MENU** on the Installer Remote to initiate the transfer of the Master TV Setup to the PTC. Once the transfer is complete, the TV will exit the Installer Menu.

**Note:** The maximum number of active channels that can be transferred is 141. Total channels numbering more than 141 will result in erratic TV operation.

### 5. Add Custom Channel and Aux Source Labels for Analog Channels: 2-5-4 + MENU Mode

Enter the Installer Menu, and press **2-5-4 + MENU** on the Installer Remote. Add/edit custom text labels to channel on-screen displays. Note that digital channels often have a broadcaster generated label (see 2-5-4 + MENU procedural information on page 23). When you are finished, press **MENU** to exit 2-5-4 + MENU Mode.

### 6. Verify the TV setup.

At this point, verify that the channel lineup, channel icons, and custom labels are correct. Make sure the TV features are set per your requirements.

### 7. Lock the channel lineup.

Enter the Installer Menu, and set item **028 CH. OVERRIDE** to **000** to lock the channel lineup and restrict access to the TV setup menus.\* Press **ENTER** to exit the Installer Menu and save your changes.

The Master TV Setup is now ready to be copied to a clone programmer (see cloning information in this document).

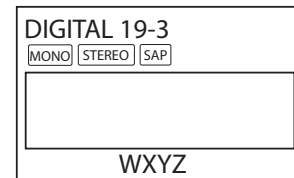

Custom Text Label "WXYZ" created in 2-5-4 + MENU (Add Channel Label) Mode.

**028 CH. OVERRIDE 000**

After verifying the TV Setup, set Installer Menu item 028 CH. OVERRIDE to 000.\*

\* This step prevents end users from accessing channel settings. In addition, selected picture, audio, and time settings will be inaccessible (i.e., grayed out).

Use the Installer Menu to set up or change operational settings. Refer to the table starting on the next page for brief descriptions of Installer Menu items. More detailed descriptions follow the table listing.

## Accessing the Installer Menu

Make sure the TV is ON. Using an Installer Remote, press **MENU** repeatedly until the on-screen menu locks up, and then press **9-8-7-6 + ENTER** to access the Installer Menu.

The Installer Menu opens with item 000 INSTALLER SEQ 000. Use the Up/Down arrow keys to sequence through the available menu items, or access an item directly by keying in the line number and then pressing **MENU**. For example, to access the SLEEP TIMER option, which is item 015, press 0-1-5 + MENU. To change a setting, use the Left/Right arrow keys, or enter a value directly.

## Using the Installer Menu

Items 000 ~ 119 are immediately accessible only upon entering the Installer Menu. Refer to the table on pages 16 and 17 for an overview of Installer Menu items, including item numbers, functions, ranges, and default values. Installer Menu items not relevant to these TV series are not present on the Installer Menu; therefore, some numbers are missing. For example, item 006 will not appear.

## Exiting the Installer Menu and Activating Updates

To exit the Installer Menu, press **ENTER** again. Any changes you make will be stored in non-volatile memory. Turn the TV OFF and then back ON to activate changes.

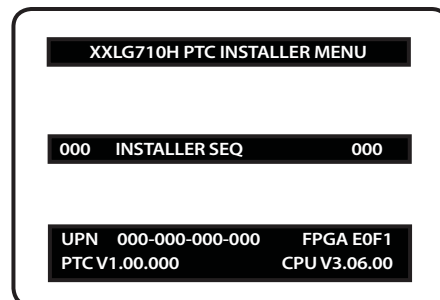

Typical TV Installer Menu



# Installer Menu (Cont.)

## Installer Menu Items 000 through 071

Menu Item	Function	Value Range	Default Value	Brief Description of Function and Comments
000	INSTALLER SEQ	0 ~ 3	0	Leave default set to 0.
001	POWER MANAGE	0 ~ 7	0	Sets number of hours of no activity before automatic shutoff.
002	AC ON	0 / 1	0	Set to 1 to enable Auto Turn ON when AC power is applied.
003	BAND/AFC	0 ~ 3	1	Selects Tuning Band: 0=Broadcast, 1=CATV, 2=HRC, 3=IRC
004	STRT CHANNEL	0 ~ 127, 255	255	Channel tuned when TV is turned ON. (Set to 255 to tune to channel tuned before TV turned OFF.)
005	CHAN LOCK	0 / 1	0	If set to 1, cannot tune from current channel.
007	STRT VOLUME	0 ~ 63, 255	255	Volume level when TV is turned ON. (Set to 255 to use volume level before TV turned OFF.)
008	MIN VOLUME	0 ~ 63	0	Sets minimum allowable volume setting.
009	MAX VOLUME	0 ~ 63	63	Sets maximum allowable volume setting.
010	MUTE DISABLE	0 / 1	0	Set to 1 to disable Mute Function.
011	KEY DEFEAT	0 / 1	0	Set to 1 to disable menu navigation keys on display panel.
015	SLEEP TIMER	0 / 1	1	Set to 1 to enable Sleep Timer.
016	EN TIMER	0 / 1	0	Set to 1 to enable On/Off Timers.
017	ALARM	0 / 1	1	Set to 1 to enable Alarm.
021	V-CHIP	0 / 1	1	Set to 1 to enable V-Chip (Parental Control) functions.
022	MAX BLK HRS	0 ~ 99	12	Sets number of V-Chip blocking hours.
023	CAPTION LOCK	0 / 1	0	Set to 1 to retain caption setting set before TV turned OFF.
028	CH. OVERRIDE	0 / 1	1	If set to 0, limits direct access to favorite channels.
029	OLD OCV	0 / 1	0	Set to 1 to change MPI operation to OCV.
030	ACK MASK	0 / 1	0	If set to 1, changes MPI for some OCV boxes.
031	POLL RATE	20 ~ 169	94	Selects poll rate for MPI.
032	TIMING PULSE	186 ~ 227	207	Sets baud rate for MPI.
034	CAMPORT EN	0 / 1	1	Set to 1 to enable Video 2 input.
035	COMPPOINT EN.	0 / 1	1	Set to 0 to disable HDMI 1. Set to 1 enable HDMI 1.
038	YPrPb EN.	0 / 1	1	Set to 1 to enable display panel Component Video 1 input jacks.
039	REAR AUX EN	0 / 1	1	Set to 1 to enable display panel Video 1 input jack.
040	AUTO CAMPORT	0 / 1	1	Set to 1 to automatically switch to Camport. If set to 1, STRT AUX SRCE cannot be set to 2.
046	STRT AUX SRCE	1 ~ 6, 255	6	Sets the starting Aux source (if item 004 STRT CHANNEL is set to 0).
047	AUX STATUS	0 / 1	0	Set to 1 for MPI Aux source to be reported as a channel number instead of Channel 0.
053	DIS. CH-TIME	0 / 1	0	Set to 1 to disable Channel-Time display.
069	EN. CH-T COL.	0 / 1	1	Set to 1 to enable custom color for the Channel-Time display.
070	FOR. CH-TIME	0 ~ 7	2	Chooses custom foreground color for the Channel-Time display.
071	BCK. CH-TIME	0 ~ 7	2	Chooses custom background color for the Channel-Time display.

## Installer Menu Items 073 through 119

Menu Item	Function	Value Range	Default Value	Brief Description of Function and Comments
073	CH NOT AVBLE	0 / 1	0	If set to 1 and Channel Override is 0, "NOT AVAILABLE" message is displayed when directly accessing a channel not in the favorite Channel List.
075	REVERT CH	0 / 1	0	If set to 1 and loss of MPI communication occurs, TV tunes to Start Channel.
078	UPN MSB	0 ~ 255	0	User programmable number, most significant byte.
079	UPN MSB-1	0 ~ 255	0	User programmable number, most significant byte - 1.
080	UPN MSB-2	0 ~ 255	0	User programmable number, most significant byte - 2.
081	UPN LSB	0 ~ 255	0	User programmable number, least significant byte.
082	CHKSM ERROR	0 / 1	1	Enforces rigid MPI checksum.
083	HANDSHK TIME	0 ~ 5	5	Relaxes MPI timing to be compatible with PC-based Windows-controlled systems.
084	PERMANENT BLK	0 / 1	0	Removes block hours setting for Parental Control and makes block permanent.
087	REAR RGB EN.	0/1/17 (LD65xH) 0/2/18 (LG710H)	1 (LD65xH) 2 (LG710H)	Dependent on item 093 RJP AVAILABLE setting. Set to 0 to disable RGB1. Set to 1 (LD65xH) / 2 (LG710H) to enable for RGB PC. Set to 17 (LD65xH) / 18 (LG710H) for Auto Configure.
088	EN NOISE MUTE	0 / 1	1	If set to 1, audio is muted if no signal is present.
090	KEY LOCK	0 / 1	0	If set to 1, keyboard is locked out, IR is still functional.
091	YPrPb2 EN	0 / 1	1	Set to 1 to enable HDMI 2 input.
093	RJP AVAILABLE	0, 1, 2, 5, 6	0	Set to 0 to disable. Set to 1, 2, 5, or 6 for HDMI or DVI Mode. (See detailed descriptions.)
094	SAP MENU EN	0 / 1	1	Set to 0 to disable feature on Function Menu. Set to 1 to enable feature on Function Menu.
096	DEF. ASP. RATIO	0 ~ 4	2	Sets default aspect ratio at power up. See detailed descriptions and item 106.
099	BACK LIGHTING	1 ~ 100, 101 ~ 200, 201, 202, 255	202	Sets the level of the TV picture back lighting. (See detailed descriptions.)
102	ATSC BAND	0 ~ 4	4	Selects ATSC band.
103	ATSC TUNE MODE	0 / 1	1	Set to 1 (default) for Physical Channel scan. Set to 0 for Virtual Channel scan.
104	START MINOR CH	0 ~ 255	0	Selects Minor Start Channel. Set to 0 for NTSC.
106	ASP RATIO LOCK	0 / 1	0	To retain set aspect ratio on power cycle, set to 1. Set to 0 for default ratio on power cycle.
116	VIDEO MUTE EN	0 / 1	0	Set to 0 for Normal. Set to 1 for Blank.
117	FACT DEFAULT	0 / 1	0	Set to 0 for Normal. Set to 1 to load presets for all Installer Menu settings.
118	POWER SAVINGS	1 / 3 / 7	3	If set to 1, the <i>b</i> -LAN module is always powered. If set to 3, the <i>b</i> -LAN module is only powered when TV is turned ON. If set to 7, the <i>b</i> -LAN module is never powered. For LD65xH TVs: If an MPI card is installed, POWER SAVINGS must be set to 1. (See detailed descriptions.)
119	DATA CHANNEL	0 ~ 135	0	Set to 0 to disable. Set to the RF channel number of the Data Channel for Pro:Centric operation.

# Installer Menu (Cont.)

## Detailed Descriptions of Installer Menu Items

### 000 - INSTALLER SEQUENCE

Specifies entry sequence to the Installer Menu.

0 = 9876	1 = 4321
2 = 1478	3 = 3698

### 001 - POWER MANAGE (Power Management)

Determines hours of no activity before automatic shutoff. The Power Management function is for saving energy. If set to 0, Power Manage is Off. Settings range from 0 ~ 7, with 1 ~ 7 representing the hours that the unit will remain ON, unless there has been activity from either the control panel or remote control.

### 002 - AC ON (AC Power Switchable)

If set to 1, this allows the TV to turn ON when AC power is applied. Pressing the ON button is not necessary. This is desirable if the TV is plugged into a cable box or a power outlet controlled by a wall switch. Use the Left/Right arrow keys to choose 0 or 1, where 0 is the default (OFF), and 1 is ON.

**Note:** If set to 1 (ON), the TV does not respond to On/Off commands from either the remote or the display control panel, and the SLEEP TIMER is also nonfunctional.

### 003 - BAND/AFC (Band/Automatic Frequency Control)

There are four possible settings for this option:

0 = Broadcast	1 = CATV (default)
2 = HRC	3 = IRC

If some channels were not found by Auto Tuning (Channel Search), select the appropriate Band setting here, and add the channels using the Channel Edit option in the Channel Menu.

### 004 - STRT CHANNEL (Start Channel)

If active, this function allows you to determine the initial channel number when the TV is turned ON. This feature is useful for an in-house information channel, since the TV would always select that channel when it is turned ON. Setting this to 255 causes the last channel viewed when the TV was turned OFF, to be the tuned to channel when the TV is turned ON again.

**Note:** For a digital Start Channel, always remember to set item 104 to the Minor Start Channel number.

255 = Last channel	1 ~ 125 = Ch X	0 = Aux
126 Map to Channel 3.	127 Map to Channel 4.	

### 005 - CHAN LOCK (Channel Lock)

Channel Lock is ideal if the system must always be on the same channel. Changing channels with the Channel Up/Down or keypad numbers is impossible. Channel Lock is inactive if set to 0 (default).

Generally, this feature is used in connection with STRT CHANNEL (Installer Menu item 004) where the Start Channel may, for example, be set to 3 or 4. If the Start Channel is 3, then the TV will remain locked on channel 3.

**NOTE:** For items 007, 008, and 009

For legacy reasons, the scale used is 0–63. The PTC software will translate this to the 0–100 scale used by the TV.

To translate a TV volume level to the Installer Menu value, use the following formula:

$$\text{Installer Value} = \frac{\text{TV Value} \times 63}{100}$$

Enter only the whole number (disregard fractions).

### 007 - STRT VOLUME (Start Volume)

This function allows the Installer to determine the initial volume level setting when the TV is turned ON. This feature is useful for an in-house information channel, since the TV would always select that volume level when it is turned ON. The range of values are 0 - 63, 255. If 255 is selected, the current volume level will be retained in memory when the TV is turned OFF; at turn ON, the volume level will be automatically set at the previous or last level.

### 008 - MIN VOLUME (Minimum Volume)

This function determines the minimum volume level allowable with the Volume (VOL) Up/Down control. In this way, for example, someone cannot set the volume too low to hear. The value range is from 0 to 63. Use the Left/Right arrow keys to change values. The factory default is 0, which provides the full range of volume control, if item 009 MAX VOLUME is also set to 63. It may be best to set the same value on every TV.

**Note:** The minimum volume level cannot have a value setting higher than the maximum volume level (described below).

### 009 - MAX VOLUME (Maximum Volume)

This function determines the maximum volume level allowable with the Volume (VOL) Up/Down control. In this way, for example, someone can not set the volume level high enough to disturb others. The value range is 0 to 63, with 63 as the default, which gives the user the full range of volume control, if item 008 MIN VOLUME is also set at 0. Use the Left/Right arrow keys to change values. It may be best to set the same value on every TV.

**Note:** The maximum volume level cannot have a value setting lower than the minimum volume level (described above).

### 010 - MUTE DISABLE

Enables or disables sound mute function. If set to 1, sound cannot be muted. If set to 0, sound can be muted.

### 011 - KEY DEFEAT (Keyboard Defeat)

If set to 1, KEY DEFEAT prevents the end user from accessing the on-screen menus from the display panel—MENU, ENTER, and menu navigation keys do not function. If set to 0, those keys do function.

**Note:** Users can always access the menus by pressing MENU on the remote.

## 015 - SLEEP TIMER

If set to 1, the Sleep Timer feature may be used. If set to 0, the Sleep Timer is not available.

## 016 - EN TIMER (Enable On/Off Timers) \*

If set to 1, the Timer function is available to the end user and enabled continuously. Set to 0 to disable On/Off Timers.

**Note:** Clock must be set in order to use timers.

## 017 - ALARM \*



Gives the installer the option of making the Alarm function available to the end user. If set to 1, the Alarm function is available to the end user. Set to 0 to disable the Alarm function.

**Note:** Clock must be set before the Alarm function will work.

## 021 - V-CHIP (Parental Control) \*

Set to 1 to activate V-Chip (Parental Control) and have it available to the end user to filter and control or otherwise restrict programming content that can appear. Set to 0 to turn the V-Chip feature Off (not available to user); no programming restrictions can be set.

## 022 - MAX BLK HRS (Maximum Block Hours) \*

Sets hours from 0 to 99 for the maximum V-Chip (Parental Control) block hours. Default setting is for 12 blocking hours.

## 023 - CAPTION LOCK

If set to 0, captions are OFF when the TV is turned ON. Set to 1 to use the caption setting configured before the TV was turned OFF when the TV is turned ON.

## 028 - CH. OVERRIDE (Channel Override)

If set to 1, the user can select channels with either Channel Up/Down or by direct keypad entry. If set to 0, only those channels that are active in the TV's memory can be selected.

## 029 - OLD OCV (On Command Video™)

Set to 1 for operation with systems from On Command Corporation.

## 030 - ACK MASK

MPI Communication Parameter. Leave at default setting unless changed by Pay-Per-View provider. When set to 1, changes MPI for some OCV boxes.

## 031 - POLL RATE

MPI Communication Parameter. Selects Poll Rate for MPI. Leave at default setting unless changed by Pay-Per-View provider. Step size of 16 ms.

## 032 - TIMING PULSE

MPI Communication Parameter. Leave at default setting unless changed by Pay-Per-View provider. Sets baud rate. Step size of 4.3 uS.

\* Only affects Function Menu if enabled by some PPV providers.

## 034 - CAMPORT EN. (Camera Port Enable)

Set to 1 to enable Video 2 input on display panel. If set to 0, Video 2 input on display panel is not functional.

**Note:** S-Video overrides Video.

## 035 - COMPPORT EN. (Computer Port Enable)

Enable/disable TV display panel HDMI 1 input jack. Set to 0 to disable HDMI1. Set to 1 to enable HDMI1.

**Note:** This setting is ignored if item 093 RJP AVAILABLE is set to 1.

## 038 - YPrPb EN. (Rear Component Video Enable)

Set to 1 to enable display panel rear Component Video input jacks. Set to 0 to disable display panel rear Component Video input jacks.

## 039 - REAR AUX EN. (Rear Aux Enable)

Set to 1 to enable display panel rear Aux (Video 1) input. Set to 0 to disable display panel rear Aux (Video 1) input.

**Note:** S-Video overrides Video.

## 040 - AUTO CAMPORT

Set to 1 to automatically switch to Camport when equipment is connected to front Video input. Set to 0 to disable front Video automatic source selection.

**Note:** If set to 1, item 093 RJP AVAILABLE is automatically set to 0.

## 046 - STRT AUX SRCE (Start Aux Source)

Sets the starting Aux source. When turned ON, the TV will tune to starting Aux source if item 004 STRT CHANNEL is set to 0.

If item 093 RJP AVAILABLE is set to 0 and item 040 AUTO CAMPORT is set to 0:

1 = Video 1	4 = RGB	255 = Last Aux
2 = Video 2	5 = HDMI 2	
3 = HDMI 1	6 = Component	

If item 093 RJP AVAILABLE is set to 1:

2 = Video 2	5 = HDMI 2	6 = Component
-------------	------------	---------------

If item 040 AUTO CAMPORT is set to 1:

1 = Video 1	5 = HDMI 2
3 = HDMI 1	6 = Component
4 = RGB	

## 047 - AUX STATUS

Set to 1 for MPI Aux source to be reported as a channel number instead of channel 0. Set to 0 to disable Aux identification change. Controls MPI status channel response for Aux inputs.

## 053 - DIS. CH-TIME (Disable Channel-Time)

Set to 1 to disable the Channel-Time display; Channel-Time display will not appear. Set to 0 to enable the Channel-Time display.

## 069 - EN. CH-T COL. (Enable Channel-Time Custom Color)

Set to 1 to enable custom color for the Channel-Time display. Set to 0 to disable custom color for the Channel-Time display.

# Installer Menu (Cont.)

---

## 070 - FOR. CH-TIME (Channel-Time Display Foreground Color)

Set according to Color Chart:

0 = Black	3 = Cyan	6 = Yellow
1 = Blue	4 = Red	7 = White
2 = Green	5 = Violet	

**Note:** If foreground color and background color are the same, the menu background will be transparent.

## 071 - BCK. CH-TIME (Channel-Time Display Background Color)

Set according to Color Chart:

0 = Black	3 = Cyan	6 = Yellow
1 = Blue	4 = Red	7 = White
2 = Green	5 = Violet	

**Note:** If foreground color and background color are the same, the menu background will be transparent.

## 073 - CH NOT AVBLE (Channel Not Available)

If set to 1 and item 028 CH. OVERRIDE is set to 0, a "NOT AVAILABLE" message is displayed when directly accessing a channel not in the channel scan list available in memory.

## 075 - REVERT CH (Revert to Start Channel)

If set to 1 and loss of MPI communication occurs, TV automatically tunes to the specified Start Channel.

## 078 - UPN MSB (UPN Most Significant Byte)

User programmable number, most significant byte readable by MPI command. Not linked to serial number.

## 079 - UPN MSB-1 (UPN Most Significant Byte-1)

User programmable number, most significant byte-1 readable by MPI command. Not linked to serial number.

## 080 - UPN MSB-2 (UPN Most Significant Byte-2)

User programmable number, most significant byte-2 readable by MPI command. Note: Not linked to serial number.

## 081 - UPN LSB (UPN Least Significant Byte)

User programmable number, least significant byte readable by MPI command. Note: Not linked to serial number.

## 082 - CHKSM ERROR (Checksum Error)

Enforces rigid MPI checksum validation. Set to 1 for validation. Set to 0 to disable (does not check checksum on MPI async port). SPI is always checked.

## 083 - HANDSHK TIME (Handshake Time)

Adds an additional delay to the handshake time which is 64 msec, thus relaxing MPI timing requirements to be compatible with PC-based Windows controlled systems. Range is 0 - 5. (Timeout = 25.5MS + [25.5 MS\* Handshake time].)

## 084 - PERMANENT BLK (Permanent Block)

Allows Lock (Parental Control) blocking schemes to be permanent by disabling the blocking hours function. Set to 1 to install Parental Control restrictions permanently. Set to 0 for user-specified hours control of blocking schemes.

## 087 - REAR RGB EN. (Rear RGB Enable)

Controls access to rear RGB input on TV. Set to 0 to disable RGB input. Set to 1 (LD65xH) / 2 (LG710H) to enable for PC RGB input. Set to 17 (LD65xH) / 18 (LG710H) to initiate a one-time automatic configuration after an AC power cycle; otherwise, automatic adjustment will be performed each time the RGB input is accessed.

## 088 - EN NOISE MUTE (Enable Noise Mute)

If set to 1, audio mutes if no signal is present.

## 090 - KEY LOCK

If set to 1, front keyboard buttons Channel, Volume, and Captions are disabled, Power button remains enabled. If set to 0, front keyboard Channel, Volume, Captions and Power buttons are all enabled.

## 091 - YPrPb2 EN. (HDMI2 Enable)

Set to 0 to disable display panel HDMI2 input. Set to 1 to enable DTV mode. Set to 2 to enable PC mode.

## 093 - RJP AVAILABLE (Remote Jack Pack Available)

- 0 = Remote jack pack is not available or disabled.
- 1 = Legacy Model RJPs: HDMI Mode  
Enables RJP feature for use with full cable bundle models. In this mode, when an HDMI source is connected to the RJP, both digital video and audio are expected via the HDMI cable. If no digital audio is present, no audio will be heard.
- 2 = Legacy Model RJPs: DVI Mode  
Enables RJP feature for use with full cable bundle models. In this mode, when an HDMI/DVI source is connected to the RJP, only digital video is expected via the HDMI cable. Analog audio is provided via a separate cable, from the source, connected to an RJP AUDIO IN. If no analog audio cable is connected, tuner audio will be heard.
- 5 = Scaler Model RJPs: HDMI Mode  
Enables RJP feature for use with reduced cable bundle models. In this mode, when an HDMI source is connected to the RJP, both digital video and audio are expected via the HDMI cable. If no digital audio is present, no audio will be heard.



- **6 = Scaler Model RJP: DVI Mode**  
Enables RJP feature for use with reduced cable bundle models. In this mode, when an HDMI/DVI source is connected to the RJP, only digital video is expected via the HDMI cable. Analog audio is provided via separate cable, from the source, connected to an RJP AUDIO IN. If no analog audio cable is connected, tuner audio will be heard.

#### Notes:

See Reference section, "RJP Model List and Input Auto-sensing Hierarchy." If RJP AVAILABLE is set to 1, 2, 5, or 6, item 040 AUTO CAMPORT is automatically set to 0. Settings 1, 2, 5, and 6 allow the lodge staff to customize each TV's RJP setup based on customer requirements.

#### 094 - SAP MENU EN (2nd Audio Program)

Set to 1 to enable SAP feature on Function menu, if Function menu is available. Set to 0 to disable SAP feature on Function menu, if Function Menu is available.

#### 096 - DEF. ASP. RATIO (Default Aspect Ratio)

Selects default aspect ratio at power up.

- Set to 0 for Set By System.
- Set to 1 for 4:3.
- Set to 2 for 16:9 (Factory Default).
- Set to 3 for Just Scan.
- Set to 4 for Zoom.

**Note:** Only applies if item 106 ASP RATIO LOCK is disabled, set to 0.

#### 099 - BACK LIGHTING

Sets the TV screen brightness at power up. Default setting is 202.

- 1 - 100 Static Back Lighting  
(1 = Dimmest picture, 100 = Brightest picture)
- 101 - 200 Dynamic Back Lighting  
(101 = Dimmest picture, 200 = Brightest picture)
- 201 Automatic Static Back Lighting
- 202 Automatic Dynamic Back Lighting
- If set between 101 and 200, the TV automatically controls back lighting depending upon the picture level of the current program.
- If set to 201, the TV automatically controls back lighting depending upon external spectral sensitivity.
- If set to 202, the TV automatically controls back lighting depending upon external spectral sensitivity and the picture level of the current program.
- If set to 255, back lighting is controlled via the Picture settings in the TV's setup menus.

#### 102 - ATSC BAND

Sets up TV to receive different types of incoming signals: 0=Broadcast, 1=CATV, 2=HRC, 3=IRC, 4=Same as NTSC.

#### 103 - ATSC TUNE MODE

Sets ATSC tuning mode: Default set to 1 for Physical Channel scan. Set to 0 for Virtual Channel scan.

#### 104 - START MINOR CHANNEL

Sets XXX-XXX digital Minor Start Channel at power up. 0=NTSC. If not 0, number selected is the digital Minor Start Channel number.

#### 106 - ASP RATIO LOCK (Aspect Ratio Lock)

Set to 1 to retain previous aspect ratio with power off. Set to 0 to retain default aspect ratio with power off. See item 096 DEF. ASP. RATIO above.

#### 116 - VIDEO MUTE EN (Video Mute Enable)

Set to 0 for Normal. Set to 1 for Blank.

#### 117 - FACT DEFAULT (Factory Default)

Set to 0 for normal. Set to 1 to load presets of all Installer Menu item settings.



**Warning: If set to 1, this will reload the factory defaults and clear the Channel List, including any assigned channel icons and custom channel labels.**

#### 118 - POWER SAVINGS

Default is set to 3. When the TV is in Standby mode, the MPI card slot is powered by the Standby power supply and embedded *b*-LAN is not powered. When the TV is in Power On mode, the MPI card slot is powered by the main 12V power supply and embedded *b*-LAN is powered. Note that the TV must be turned ON in order to communicate with the Embedded *b*-LAN module for configuration and control when POWER SAVINGS is set to 3.

**Note:** MPI cards with *b*-LAN technology—LMT7Z5, LMT7Z7, LMT7Z9—are NOT supported on TVs in which the *b*-LAN module is embedded.



**Warning for LD65xH TVs: If an MPI card is installed, POWER SAVINGS must be set to 1. The default setting does not support this feature.**

- 1 = MPI card slot Standby Mode power provided from Standby power supply, and Embedded *b*-LAN is always powered.
- 3 = MPI card slot Standby Mode power provided from Standby power supply, and Embedded *b*-LAN is only powered when the TV is turned ON.
- 7 = MPI card slot Standby Mode power provided from Standby power supply, and Embedded *b*-LAN (including the Pro:Centric data tuner) is never powered.

**Note:** See Reference section, "b-LAN Setup & Overview," for further information.

#### 119 - DATA CHANNEL

Set to 0 (default) to disable. Set to the RF channel number of the Data Channel for Pro:Centric operation. The TV may take several minutes to load EPG data after AC power is initially applied.

# TV Setup Menus Overview

On-screen setup menus control the features of the TV. Press **MENU** on the Installer Remote to access the TV setup menus, and set the TV features to the desired configuration for the end user.

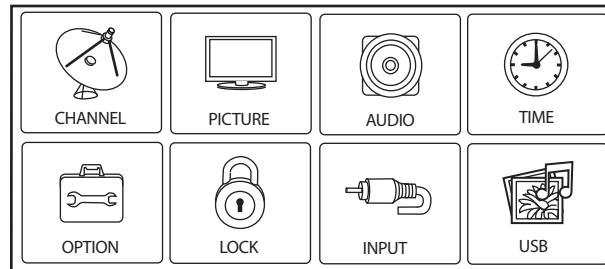

**CHANNEL** Move Enter

- Auto Tuning
- Manual Tuning
- Channel Edit
- Channel Label

**PICTURE** Move Enter

- Aspect Ratio : 16:9
- Picture Mode : Standard
- Backlight 90
- Contrast 90
- Brightness 50
- Sharpness 50
- Color 50
- Tint 0

**AUDIO** Move Enter

- Auto Volume : On
- Clear Voice II : On
- Level 3
- Balance : 0
- Sound Mode : Standard
- SRS TruSurround XT: Off
- Treble 50
- Bass 50

**TIME** Move Enter

- Clock : : - - - - - : - - - - -
- Off Time : Off
- On Time : Off
- Sleep Timer : Off

**OPTION** Move Enter

- Menu Language : English
- Audio Language : English
- Caption : Off
- Set ID : 1
- Demo Mode : Off
- Data Broadcasting

**LOCK** Move Enter

- Lock System : Off
- Set Password
- Block Channel
- Movie Rating
- TV Rating-Children
- TV Rating-General
- Downloadable Rating
- Input Block

**INPUT** Move Enter

- TV
- AV1
- AV2
- Component
- RGB-PC
- HDMI1
- HDMI2

**USB** Move Enter

- Photo List
- Music List
- Extra Contents
- Eject



# Adding Channel Label Icons / Custom Channel Labels (2-5-4 + MENU Mode)

## Editing/Adding Channel Icons and/or Labels

If there is no pre-assigned icon, you can make a custom channel label of up to seven (7) characters to help identify a channel or network. If desired, channel labels can also be added in addition to a pre-assigned icon. You may also add labels for the Aux input sources to clearly identify the devices that are connected to the Aux inputs.

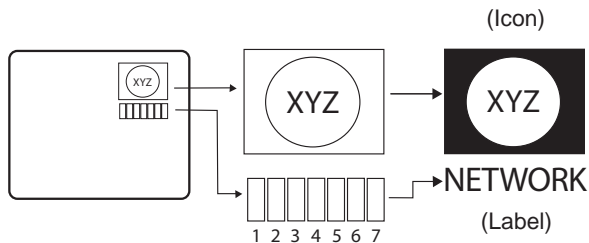

Editing and adding the labels can only be done if there are channels entered into the TV's Channel Map either during Commercial Mode Setup (see pages 13 to 14), by cloning, or by using some PPV provider's master remote controls. **Note:** A blank letter space is available between "Z" and "!".

## To perform channel editing/labeling:

1. Enter the TV Installer Menu.
2. Press **2-5-4 + MENU** on the Installer Remote to enter the Channel Label Editing Mode.
3. Add channel icons and channel labels as described in the procedures below. (You can do this more than once.)
4. To exit the menu when you are done, press **MENU**.

## Changing a Channel's Icon on the Master TV

1. Use Channel Up/Down to select the channel for which to change the icon.
2. Use the Left/Right arrow keys to select the thin letter "I" on the Channel ID display.
3. Use the Up/Down arrow keys to select the icon with which you want to identify the channel. (If you know the icon number, enter the number, and press **ENTER**.)
4. Proceed to change/add channel labels, or go to the next channel.

## Changing/Adding Channel Labels on the Master TV

1. Use Channel Up/Down to select the desired channel.
2. Press the Left/Right arrow repeatedly until the numbers 1 to 7 appear on the display. The number shows the position of the character that can be changed. Number 1 is the first character, number 2 the second character, etc.
3. Use the Up/Down arrow keys to select the desired character.
4. Proceed to the next number position, or use Channel Up/Down to go to the next channel.

## Changing Source Labels on the Master TV

1. Press **INPUT** to select the desired Aux input source: A/V 1, A/V 2, HDMI Component, RGB, etc.
2. Press the Left/Right arrow repeatedly until the numbers 0 to 9 appear on the display. The number shows the position of the character that can be changed.
3. Use the Up/Down arrow keys to select the desired character.
4. Press **INPUT** for the next Aux source, or proceed to change an icon or change/add labels. Use Channel Up/Down to return to channels.

## Installer Remote Control Key Functions for Master TV Channel Editing/Labeling Menu

- **Channel Up/Down:** Tunes in the next channel in scan.
- **Left/Right Arrows:** Select the item to change. If "I" is shown, the icon can be changed. If a number is shown, it indicates the position of the character that can be changed.
- **Up/Down Arrows:** Select the icon or the character to be displayed. Tip: Arrows can be held down for fast scrolling.
- **0 – 9:** Use to enter the index number of the icon, if known.
- **ENTER:** Changes the icon after the number has been entered.
- **INPUT:** Changes the Aux input label.
- **MENU:** Exits the editing process.

# FTG Mode of Operation

## FTG Configuration Overview

The following steps outline local FTG configuration of individual TVs. Since these models are equipped with the EBL module, they can also be broadcast configured in FTG Mode by a Free-To-Guest Management Appliance (FMA) head end device. Refer to the **Free-To-Guest (FTG) Configuration Application** manual and/or the Installation & Setup manual for the FMA device for further information.

**Note:** FTG Configuration Application software is available online at: [www.LGcommercial.com/FTGsoftware](http://www.LGcommercial.com/FTGsoftware).

1. Install (if necessary) and launch the FTG Configuration Application (v5.0.0 or higher) on the PC that will be used to configure the EBL.
2. Build a Channel Map using the FTG Channel Map Editor in the FTG Channel Map Configuration Utility (or, if applicable, open an existing FTG Configuration (.rml) file).
3. If not already done, connect the PC to the TV-LINK CFG jack on the rear connections panel using a USB-to-TTL serial cable (TTL-232R-5V-AJ).
4. "Write" the FTG Channel Map to the EBL (converts EBL from Pass-through Mode to FTG Mode).
5. "Read" the current FTG Installer Menu settings from the EBL using the FTG Installer Menu Configuration Utility. If necessary to make changes to Installer Menu items, "Write" them back to the EBL in FTG Mode.
6. Save the FTG Channel Map and FTG Installer Menu settings to an FTG Configuration (.rml) file for future use.
7. Tune the TV to a Logical Channel in the FTG Channel Map.

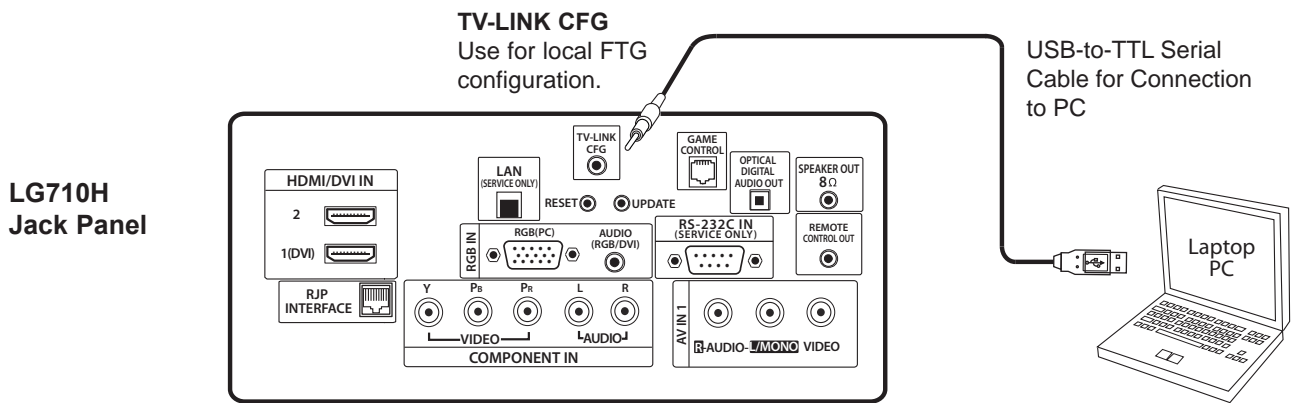
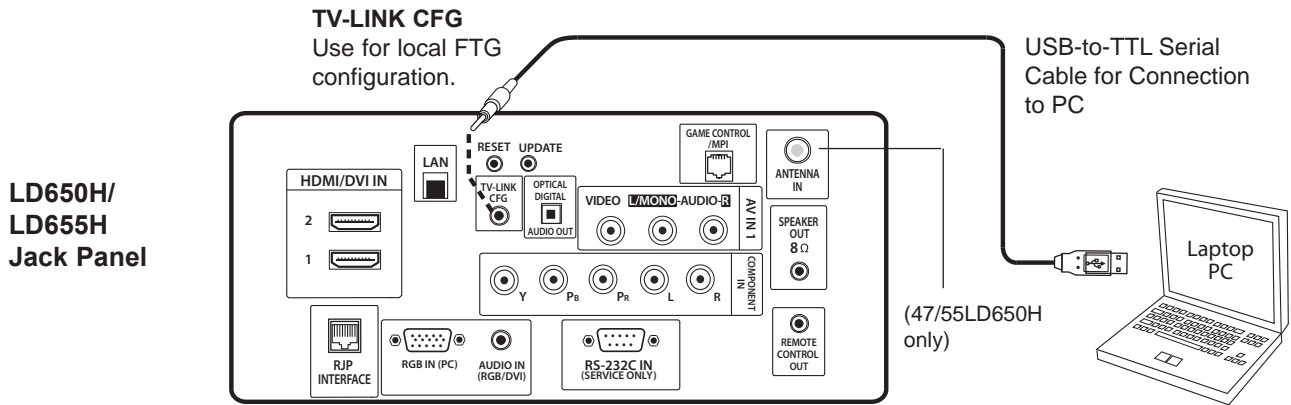

# FTG Mode of Operation (Cont.)

## Determining the TV Operating Mode / FTG Channel Map Configuration Utility Overview

To determine the operating mode of the TV, press **MENU** on the Installer Remote. If the end user Function Menu (showing aspect ratio options—see below) appears, the TV/EBL is in FTG Mode. If the TV setup menus appear, the EBL is in Pass-through Mode.

The following pages provide overviews of the FTG Channel Map and FTG Installer Menu Configuration Utilities that comprise the FTG Configuration Application. Refer to the **Free-To-Guest (FTG) Configuration Application** manual for further information.

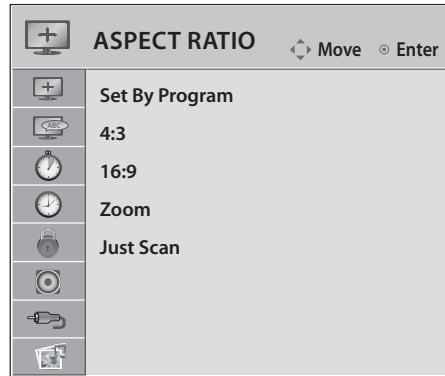

### Function Menu

Shows that the EBL is in FTG Mode. While this menu is present on-screen, Installer Menu settings can **ONLY** be accessed/changed using the FTG Configuration Application.

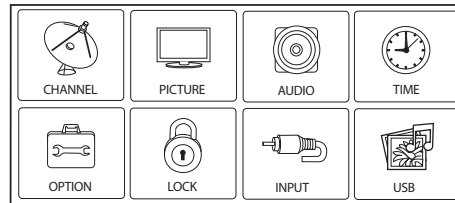

### TV Setup Menus

Shows that the EBL is in Pass-through Mode.

Writing an FTG Channel Map into the EBL will switch the EBL from Pass-through Mode to FTG Mode.

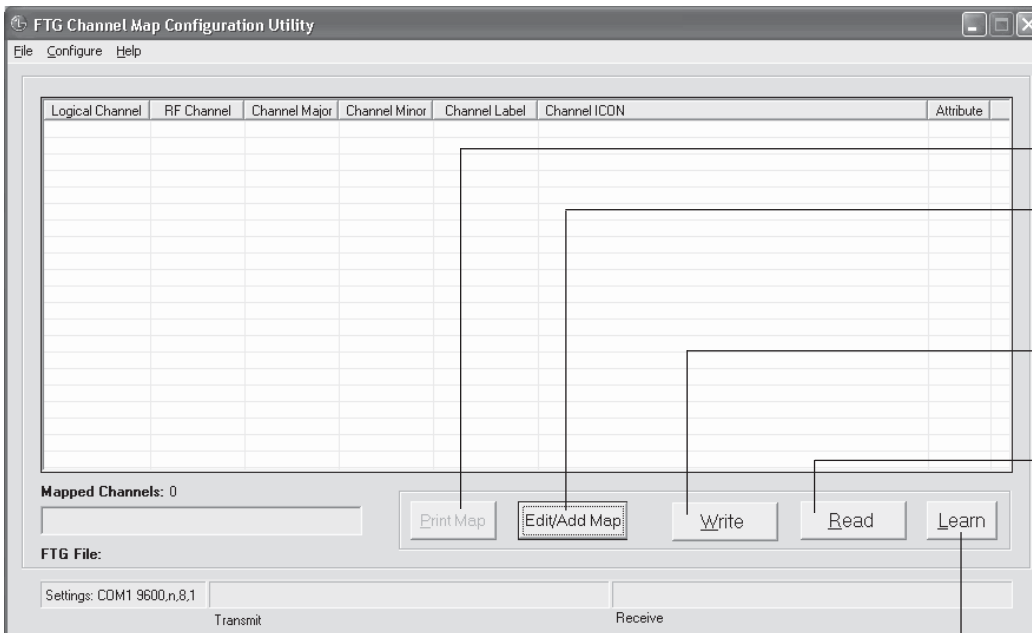

### PRINT MAP

Click to display a printable FTG Channel Map Report. The report can also be exported as an HTML or Text file.

### EDIT/ADD MAP

Click to open the FTG Channel Map Editor to create or edit an FTG Channel Map (see next page).

### WRITE

Click to transfer the FTG Channel Map to the EBL.

### READ

Click to transfer the FTG Channel Map from the EBL to the FTG Configuration Application.

### FTG CHANNEL MAP CONFIGURATION UTILITY

### LEARN

Click to transfer the TV Channel Map from the PTC to the EBL and the FTG Configuration Application. (Requires that 2-5-5 + MENU was performed to transfer TV Channel Map to PTC.) \*

\* Logical Channel numbers will automatically be assigned in ascending order, starting with 0 (zero), to the Physical Channels from the TV Channel Map.

# FTG Mode of Operation (Cont.)

## FTG Channel Map Configuration Utility / FTG Channel Map Editor Overview

The FTG Channel Map Editor shows a single Logical Channel's Data and the FTG Channel Map.

### LOGICAL CHANNEL MAPPING

Select a Logical Channel number, then assign it the RF, Major, and Minor channel numbers to complete the mapping.

### CUSTOM CHANNEL LABELS/ICONS

Enter custom labels and select icons by name on menu or by number.

### SET CHANNEL ATTRIBUTES

Check/select Encrypted, OSD, or Blank Video.

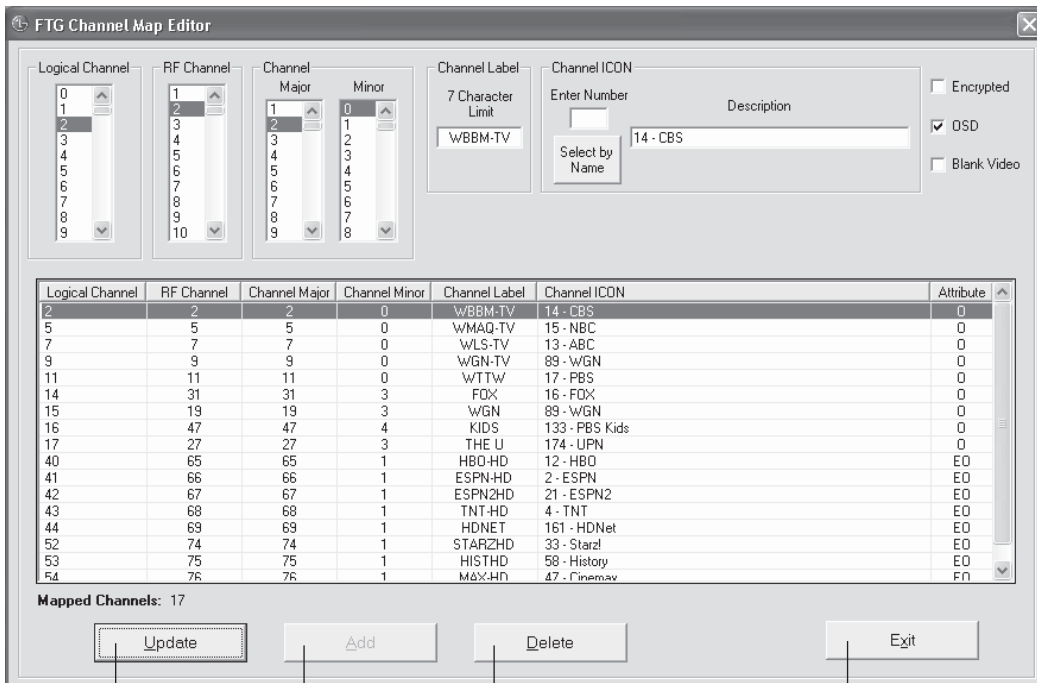

### UPDATE

After editing an existing Logical Channel's data, click to commit the changes in the FTG Channel Map.

### ADD

After defining a new Logical Channel, click to add channel to the FTG Channel Map.

### DELETE

Click to remove highlighted channel from FTG Channel Map.

### EXIT

Click to exit editor and return to FTG Channel Map Configuration Utility.

# FTG Mode of Operation (Cont.)

## FTG Installer Menu Configuration Utility Overview

### CONFIGURATION SETTINGS

Select tabs for categories of Installer Menu items to set up TV.

### HOSPITAL-GRADE TV ONLY

Set Hospital items on Installer Menu for hospital-grade TVs.

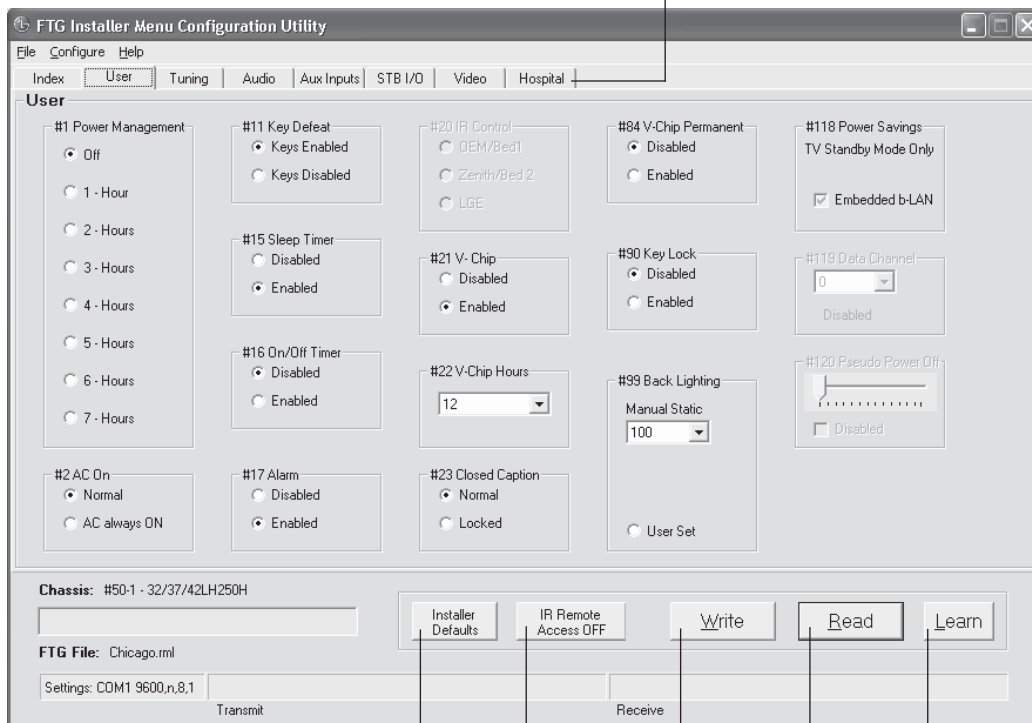

### INSTALLER DEFAULTS

Click to reset FTG Installer Menu items shown in the FTG Configuration Application to defaults.

### IR REMOTE ACCESS

Toggle IR Remote Access to ON to obtain access to TV setup menus and Installer Menu.

### WRITE

Click to transfer the FTG Installer Menu settings to the EBL.

### LEARN

Click to transfer Installer Menu settings from the PTC to the EBL and FTG Configuration Application. \*

### READ

Click to transfer the Installer Menu settings in the EBL to the FTG Configuration Application.

\* Logical Channel numbers will automatically be assigned in ascending order, starting with 0 (zero), to the Physical Channels from the TV Channel Map.

# Cloning Overview / Clonable Menu Features

## IMPORTANT CLONING INFORMATION

There are three options for cloning a Master TV Setup:

- Using a USB memory device
- Using a TLL-1100A clone programmer
- Using a LT2002 clone programmer

Each option is described in further detail on the pages that follow. As you perform cloning procedures, be sure to complete each task as indicated. If a procedure or step is omitted or not performed completely, cloning may not work. At each step, pay attention to ensure the TV screen shows the proper message when cloning. If the message indicated does not appear, there is a problem with that step, and cloning may not be successful.



**Warning: Copying a blank or incorrect memory into a TV, STB, or other device will cause the TV, STB, or other device to operate erratically or become inoperable.**



**Warning: Do not connect a clone programmer to any PPV card installed in the Master TV or any MPI port while the TV is in PPV Mode, or the clone programmer and the PPV card will be damaged.**

### Before you begin cloning:

- Complete the Commercial Mode Setup procedure on pages 13 to 14.
- The Master TV EBL must be in Pass-through Mode.
- Ensure the Master TV is connected to a good, stable signal source, the TV source selected is Antenna (RF) In, and the signal is from an Aux source or analog (not a digital) channel.
- All equipment should be connected to power and turned ON.
- Learning and Teaching is only possible between identical model TV/STBs.
- Make sure the batteries in the clone programmer, if applicable, are fresh. If batteries are removed, the Clone Clock Time will be lost.
- If using a USB memory device, ensure the memory device has been formatted with FAT format.
- If using a clone programmer, decide if you want to set the time from the clone programmer or copy the time to the clone programmer from a compatible TV which has the clock set to the current time.

## Clonable Menu Features

### Installer Menu

Installer Menu item settings

### Channel

Auto Tuning (Channel Lineup)  
Channel Edit  
Channel Label

### Picture

Aspect Ratio  
Picture Mode  
Advanced Control

### Audio

Auto Volume  
Clear Voice  
Sound Mode  
Balance  
TV Speaker

### Option

Menu Language  
Audio Language  
Caption  
Caption Mode  
Digital Caption Options

### Lock

Movie Rating  
TV Rating – Children  
TV Rating – General  
Input Block

### Time

Auto Clock  
Manual Clock  
Off Time  
On Time  
Auto Off (Sleep Timer)

**Note:** Menu options vary between analog and digital channels and Aux sources.

## Learning / Teaching a Master TV Setup using a USB Memory Device

### USB Cloning Notes

- Read the IMPORTANT CLONING INFORMATION on page 28 before beginning any cloning procedures.
- Do not remove the TV power cord or the USB memory device while Learning or Teaching, as doing so may harm the USB memory device.
- You may edit a filename as part of the Learning procedure; however, a file with edited contents will not be recognized.
- Since clock data is copied into the USB memory device as numeric data, the time difference between Teaching and Learning is not automatically adjusted. Either set the clock manually, or use the Auto Clock setting in the TV setup menus.

### Learn Setup from Master TV

1. Ensure the Master TV is set up completely and the EBL is in Pass-through Mode.
2. Plug the USB memory device into the USB IN port on the Master TV.
3. Press **MENU** to display the TV setup menus.
4. Use the arrow navigation keys to select/highlight the **Option** menu icon; then, press the number “7” key a total of seven times to display the USB Download Menu.
5. To gain access to the Learn From TV option in the USB Download Menu, key in the password used to enter the Installer Menu (Example: Press **9-8-7-6**).
6. Use the Up/Down arrow keys to select **Learn From TV** and press **ENTER**.
7. To identify the profile from others, you can use the Up/Down arrow keys to change the last five digits of the filename. Press **ENTER** when you are ready to initiate Learning.

Learning status will be shown on the progress bar. When the Learning process is complete, the USB Download menu will reappear on screen.

8. Remove the USB memory device.

### Teach Master TV Setup to Target TV

1. Plug the USB memory device with the Master TV Setup file into the Target TV USB IN port.
2. Press **MENU** to display the TV setup menus.
3. Use the arrow navigation keys to select/highlight the **Option** menu icon; then, press the number “7” key a total of seven times to display the USB Download Menu.
4. Use the Up/Down arrow keys to select **Teach To TV** and press **ENTER**.
5. Use the Up/Down arrow keys to select/highlight the Master TV Setup you want to install and press **ENTER**. Note: Filenames identify the TV and the TLL version (see figure at right).

Teaching status will be shown on the progress bar. When the Teaching process is complete, the USB Download menu will reappear on screen.

6. When Teaching is done, remove the USB memory device, turn OFF the TV, and unplug the TV power cord for 15 seconds.
7. Reconnect the TV power cord, and turn ON the TV. The Master TV Setup should be resident on the Target TV.

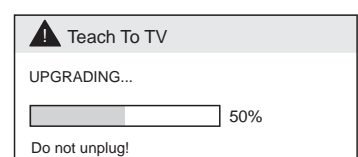
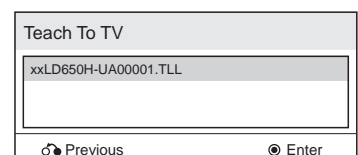
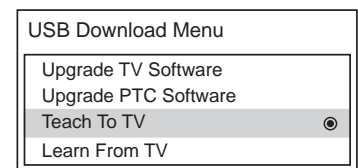
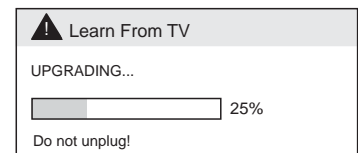
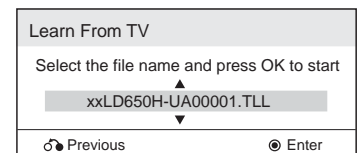
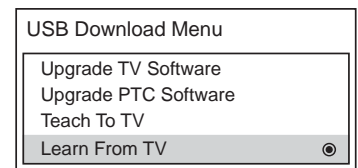



# Cloning Procedures (Cont.)

## Learning / Teaching a Master TV Setup using a TLL-1100A Clone Programmer

**Warning:** Do not connect a clone programmer to any PPV card installed in the Master TV or any MPI port while the TV is in PPV Mode, or the clone programmer and the PPV card will be damaged.

Cloning is accomplished using the TV/clone programmer MPI ports for communication (see figure).

### TLL-1100A Cloning Notes

- Read the IMPORTANT CLONING INFORMATION on page 28 before beginning any cloning procedures.
- Ensure the TLL-1100A is either fully charged or connected to AC power.
- Teaching and Learning is only possible between identical model TVs/STBs; however, the TLL-1100A clone programmer can store up to eight different Master TV Setups.

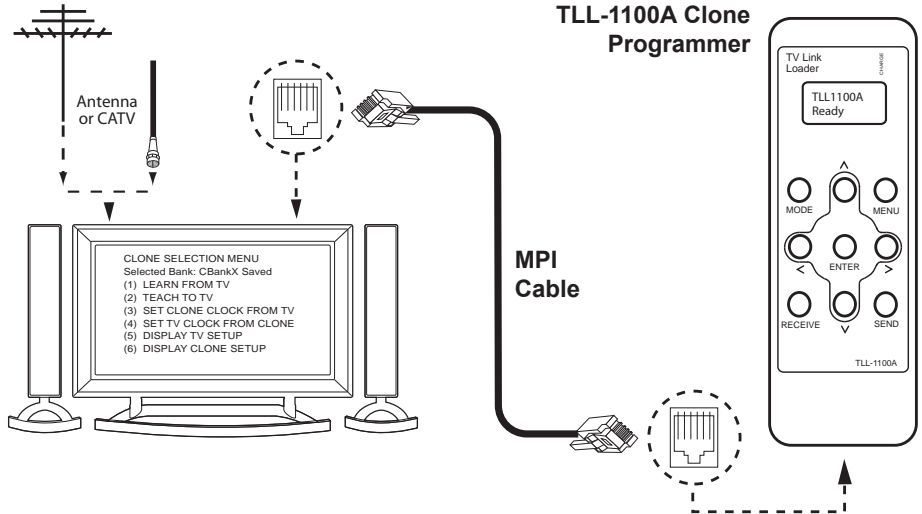

### Learn Setup from Master TV

1. Ensure the Master TV is set up completely and the EBL is in Pass-through Mode.
2. If an analog channel is not available, tune the TV to an Aux source, such as AV-1. Then, plug one end of the MPI cable into the TV MPI port.
3. Turn ON the TLL-1100A.
4. Use the **MODE** button on the TLL-1100A to select **Clone Mode**.
5. Use the Left/Right arrows on the TLL-1100A to select the Memory CBank (1 to 8) in which to store the Master TV Setup.
6. Plug the other end of the MPI cable into the MPI port on the bottom of the TLL-1100A. The Clone Selection Menu will display on the TV screen.
7. Press **1** on the Installer Remote to select **LEARN FROM TV** from the Clone Selection Menu. Then, press ENTER to transfer the Master TV Setup into CBankX on the TLL-1100A.

CLONE SELECTION MENU  
 Selected Bank: CBankX Saved  
 (1) LEARN FROM TV  
 (2) TEACH TO TV  
 (3) SET CLONE CLOCK FROM TV  
 (4) SET TV CLOCK FROM CLONE  
 (5) DISPLAY TV SETUP  
 (6) DISPLAY CLONE SETUP

CLONE CLOCK = XX:XX  
 TV CLOCK = XX:XX  
 THE CLONE IS VERSION VX.X.X

- To change menu items, press channel keys or digits.
- To execute item, press Enter.

Learning usually takes about 90 seconds. "LEARNING IN PROGRESS" will be displayed on the screen while the TLL-1100A copies the Master Setup. When the Learning process is complete, a "LEARNING COMPLETE" message will be displayed.

## Learning / Teaching a Master TV Setup using a TLL-1100A Clone Programmer (Cont.)

---

### (Optional) Set the Clock

Set the time on a Master TV's clock. (If the time has already been copied from a TV into the TLL-1100A clone programmer, you can set the Master TV's clock by copying the time from the clone programmer.) The TLL-1100A can copy the current time to both a Master TV and to the clone's internal clock—accurate to within one minute.

Since the TLL-1100A's time cannot be set directly, the current time needs to be copied from an LG TV equipped with MPI input capability.

After the time is copied to the TLL-1100A clone programmer, the current time can then be transferred to another TV. (This can be a Master TV or another TV which has already had the features set up.)

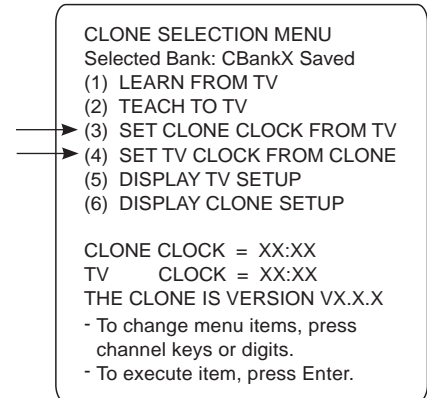

### Teach Master TV Setup to Target TV

1. When Learning is complete, disconnect the MPI cable from the Master TV, and connect it to the MPI port on the Target TV. The Clone Selection Menu will display on the TV screen.
2. Ensure the correct Memory CBank(X) is selected on the TLL-1100A.
3. Press **2** on the Installer Remote to select **TEACH TO TV** from the Clone Selection Menu. Then, press **ENTER** to transfer the Master TV Setup to the Target TV.

Teaching usually takes 3 to 4 minutes. "TEACHING IN PROGRESS" will be displayed on the screen during Teaching. When the Teaching process is complete, a "TEACHING COMPLETE" message will be displayed.

4. When Teaching is done, disconnect the MPI cable from the Target TV, turn OFF the TV, and unplug the TV power cord for 15 seconds.
5. Reconnect the TV power cord, and turn ON the TV. The Master TV Setup should be resident on the Target TV.

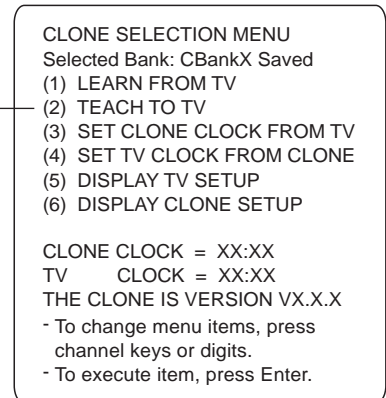

# Cloning Procedures (Cont.)

## Learning / Teaching a Master TV Setup using an LT2002 Clone Programmer

**Warning:** Do not connect a clone programmer to any PPV card installed in the Master TV or any MPI port while the TV is in PPV Mode, or the clone programmer and the PPV card will be damaged.

Cloning is accomplished using the TV/clone programmer MPI ports for communication (see figure).

### LT2002 Cloning Notes

- Read the IMPORTANT CLONING INFORMATION on page 28 before beginning any cloning procedures.
- A slow flashing green light indicates that there are communication problems between the TV and the LT2002 clone programmer. If this is the case, check for a damaged cable, poor contacts, or other connection troubles.
- If the status indicator is red, the LT2002 batteries are low and should be replaced. Install four (4) high-quality alkaline AA batteries.
- Teaching and Learning is only possible between identical model TVs/STBs; however, the LT2002 clone programmer can store up to three different Master TV Setups.

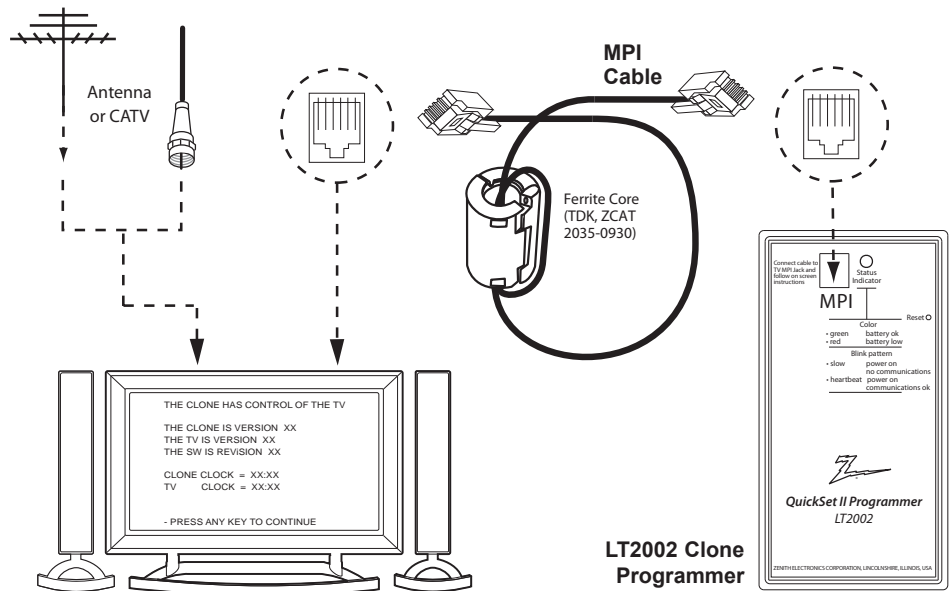

### Learn Setup from Master TV

1. Ensure the Master TV is set up completely and the EBL is in Pass-through Mode.
2. If an analog channel is not available, tune the TV to an Aux source, such as AV-1. Then, plug one end of the MPI cable into the TV MPI port.
3. If there is a good connection after the LT2002 is connected to the TV MPI port, "THE CLONE HAS CONTROL OF THE TV" message will appear on the TV screen. Press any key on the Installer Remote to access the LT2002 Clone Selection Menu.
4. Press **1** on the Installer Remote to select **LEARN FROM TV** from the Clone Selection Menu; then press **ENTER** to proceed to the Memory Bank Selection Menu (see sample screen on next page).
5. Select the clone Memory Bank in which to store the Master Setup by pressing either Channel key repeatedly to choose Memory Bank 1, 2, or 3. Note: If you choose a Memory Bank that already has a Master device's setup programmed into it, that setup will be overwritten by the new Master TV Setup.

THE CLONE HAS CONTROL OF THE TV

THE CLONE IS VERSION XX  
THE TV IS VERSION XX  
THE SW IS REVISION XX

CLONE CLOCK = XX:XX  
TV CLOCK = XX:XX

- PRESS ANY KEY TO CONTINUE.

- DISCONNECT CLONE WHEN DONE.

CLONE SELECTION MENU

(1) LEARN FROM TV  
(2) TEACH TO TV  
(3) SET CLONE CLOCK FROM TV  
(4) SET TV CLOCK FROM CLONE  
(5) DISPLAY TV SETUP  
(6) DISPLAY CLONE SETUP

- TO CHANGE MENU ITEMS, PRESS CHANNEL KEYS OR DIGITS.

- TO EXECUTE ITEM, PRESS ON/OFF, POWER, OR ENTER.

(Continued on next page)

## Learning / Teaching a Master TV Setup using an LT2002 Clone Programmer (Cont.)

(Continued from previous page)

6. Once you select the clone Memory Bank, press **ENTER** on the Installer Remote. The Memory Bank you selected will be shown.
7. Press **POWER** to transfer the Master TV Setup into the selected Memory Bank on the LT2002.

Learning usually takes about 90 seconds. "LEARNING IN PROGRESS" will be displayed on the screen while the LT2002 copies the Master Setup. When the Learning process is complete, a "LEARNING COMPLETE" message will be displayed.

SAVE TV SETUP IN SELECTED CLONE MEMORY

- (1) MEMORY 1 VER XX REV XX
- (2) MEMORY 2 VER XX REV XX
- (3) MEMORY 3 VER XX REV XX
- (4) RETURN TO CLONE MENU

- TO CHANGE MENU ITEMS, PRESS CHANNEL KEYS OR DIGITS.  
- TO EXECUTE ITEM, PRESS ON/OFF, POWER, OR ENTER.

### (Optional) Set the Clock

Set the time on a Master TV's clock. (If the time has already been copied from a TV into the LT2002 clone programmer, you can set the Master TV's clock by copying the time from the clone programmer.) The LT2002 can copy the current time to both a Master TV and to the clone's internal clock—accurate to within one minute. (Another reason that the LT2002 should be equipped with fresh, high-quality alkaline batteries, is for it to keep the time as accurately as possible.)

Since the LT2002's time cannot be set directly, the current time needs to be copied from an LG TV equipped with MPI input capability.

After the time is copied to the LT2002 clone programmer, the current time can then be transferred to another TV. (This can be a Master TV or another TV which has already had the features set up.)

CLONE SELECTION MENU

- (1) LEARN FROM TV
- (2) TEACH TO TV
- (3) SET CLONE CLOCK FROM TV
- (4) SET TV CLOCK FROM CLONE
- (5) DISPLAY TV SETUP
- (6) DISPLAY CLONE SETUP

- TO CHANGE MENU ITEMS, PRESS CHANNEL KEYS OR DIGITS.  
- TO EXECUTE ITEM, PRESS ON/OFF, POWER, OR ENTER.

### Teach Master TV Setup to Target TV

1. When Learning is complete, disconnect the MPI cable from the Master TV, and connect it to the MPI port on the Target TV.
2. With "THE CLONE HAS CONTROL OF TV" message on display, press **2** on the Installer Remote to select **TEACH TO TV** from the LT2002 Clone Selection Menu. Then, press **ENTER**.
3. Select the LT2002 Memory Bank in which the new setup is located. Then, press **POWER** to transfer the Master TV Setup to the Target TV.

Teaching usually takes 3 to 4 minutes. "TEACHING IN PROGRESS" will be displayed on the screen during Teaching. When the Teaching process is complete, a "TEACHING COMPLETE" message will be displayed.

4. When Teaching is done, press any key on the Installer Remote to return to the Clone Selection Menu. Then, press **ENTER**.
5. Disconnect the MPI cable from the Target TV, turn OFF the TV, and unplug the TV power cord for 15 seconds.
6. Reconnect the TV power cord, and turn ON the TV. The Master TV Setup should be resident on the Target TV.

CLONE SELECTION MENU

- (1) LEARN FROM TV
- (2) TEACH TO TV
- (3) SET CLONE CLOCK FROM TV
- (4) SET TV CLOCK FROM CLONE
- (5) DISPLAY TV SETUP
- (6) DISPLAY CLONE SETUP

- TO CHANGE MENU ITEMS, PRESS CHANNEL KEYS OR DIGITS.  
- TO EXECUTE ITEM, PRESS ON/OFF, POWER, OR ENTER.

COPY SELECTED CLONE MEMORY TO TV

- (1) MEMORY 1 VER XX REV XX
- (2) MEMORY 2 VER XX REV XX
- (3) MEMORY 3 VER XX REV XX
- (4) RETURN TO CLONE MENU

- TO CHANGE MENU ITEMS, PRESS CHANNEL KEYS OR DIGITS.  
- TO EXECUTE ITEM, PRESS ON/OFF, POWER, OR ENTER.

# Remote Jack Pack / TV Connections & Setup

## Remote Jack Pack Setup

RJP Available? If you will use a Remote Jack Pack (RJP) in your system, set Installer Menu item **093 RJP AVAILABLE** appropriately (for example, on a legacy model RJP: HDMI Mode, set RJP AVAILABLE to 001). See Installer Menu detailed descriptions for further information.

**093 RJP AVAILABLE 001**

## TV Connections

**!** Make these connections **ONLY** after **Commercial Mode Setup and Cloning Master TV** procedures are complete.

Refer to the appropriate figure below, and connect the RJ-45 Control cable from the RJP cable bundle to the RJP INTERFACE port on the TV's jack panel. Then, connect HDMI, RGB, and Composite Video/Audio connectors, as applicable, for the cable bundle.

**LD650H/LD655H Jack Panel**

**HDMI/DVI IN 1**  
Connect HDMI connector from RJP cable bundle.

**RJP INTERFACE**  
Connect RJ-45 Control cable from RJP cable bundle.

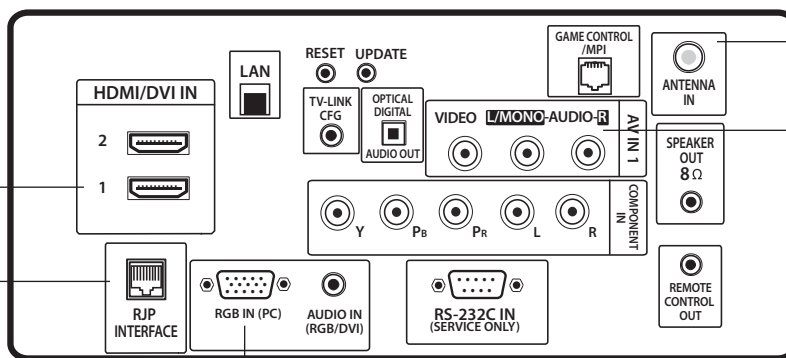

(47/55LD650H only)

**AUDIO/VIDEO IN 1**  
Connect Composite Video/Audio connectors from RJP cable bundle. (Composite Video on legacy RJP only.)

**RGB IN (PC)**  
Connect RGB connector from RJP cable bundle (legacy RJP only).

**LG710H Jack Panel**

**RGB IN (PC)**  
Connect RGB connector from RJP cable bundle (legacy RJP only).

**HDMI/DVI IN 1**  
Connect HDMI connector from RJP cable bundle.

**RJP INTERFACE**  
Connect RJ-45 Control cable from RJP cable bundle.

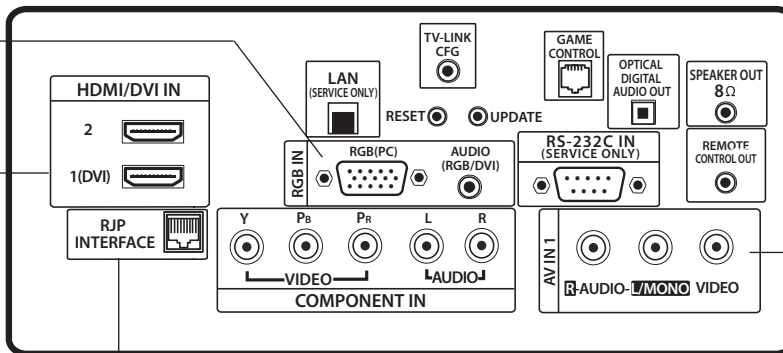

**AUDIO/VIDEO IN 1**  
Connect Composite Video/Audio connectors from RJP cable bundle. (Composite Video on legacy RJP only.)

# Reference: Upgrading TV/PTC Software with a USB Memory Device

## Checking the Software Versions

You can check the software versions of the TV by accessing the Installer Menu: Press **MENU** repeatedly until the on-screen menu locks up, and then press **9-8-7-6 + ENTER**. When you are finished, press **ENTER** again to exit the Installer Menu.

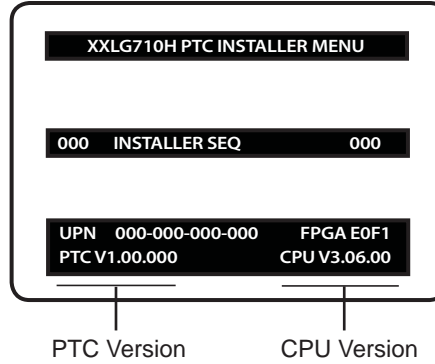

Typical Installer Menu

## Upgrading TV/PTC Software

Before you begin, note that the software upgrade files must be stored in a folder named "LG\_DTV" in the root directory of USB memory device.

1. Turn the TV ON.
2. Plug the USB memory device into the USB IN port on the TV. Note: Ensure the memory device has been formatted with FAT format.
3. Press **MENU** to display the TV setup menus.
4. Use the arrow navigation keys to select/highlight the **Option** menu icon; then, press the number "7" key a total of seven times to display the USB Download Menu.
5. Use the Up/Down arrow keys to select **Upgrade TV Software** or **Upgrade PTC Software**, as applicable, and press **ENTER**. (See screen samples at right. The TV Software Upgrade screen provides information on the current software as well as the potential software to be downloaded.)
6. Use the Up/Down arrow keys to select/highlight the upgrade to install and press **ENTER**.

Copying progress will be shown. When the upgrade is complete, the TV will turn OFF.

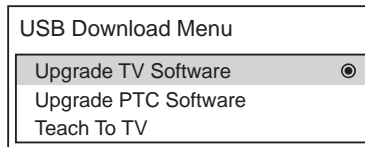

TV Software Upgrade

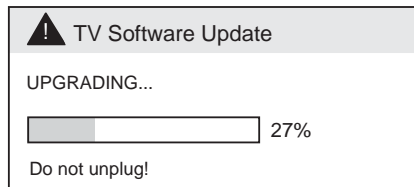
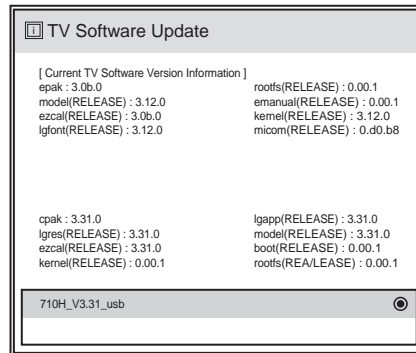

PTC Software Upgrade

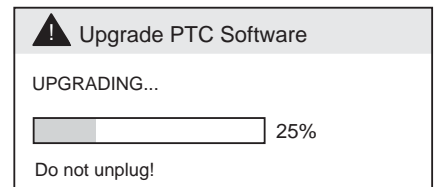
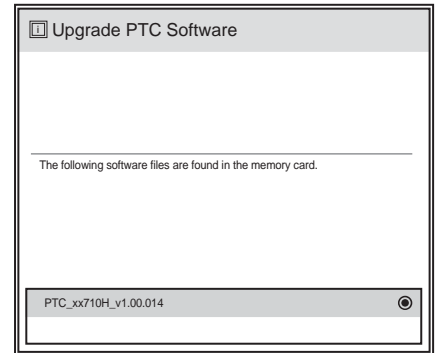

**Note:** (TV Software Upgrades only) If the TV detects a later version of software on the USB device, it will automatically display a dialog from which you can start the software upgrade immediately. Otherwise, you can close the dialog, and access the USB Download Menu as described in the procedure.



# Reference: Power Consumption Settings

## 32/37/42LD650H/LD655H

The following tables assume that Installer Menu item 118 POWER SAVINGS is set to 003 (default) and Installer Menu item 099 BACK LIGHTING is set as shown below (default value is 255).

### 32LD650H/ LD655H

Item 099 Back Lighting (Static)	Picture Lumin.	Power Consumption (Watts)	Percent Savings
100	290.2	96.1	0.00%
90	258.2	90.9	5.41%
80	220.2	84.8	11.76%
70	189.1	80.2	16.55%
60	166.6	75.5	21.44%
50	145.2	69.1	28.10%
40	126.4	63.9	33.51%
30	108.2	58.8	38.81%
20	90.2	53.2	44.64%
10	72.1	48.6	49.43%
1	57.5	44.0	54.21%

Item 099 Back Lighting (Dynamic)	Picture Lumin.	Power Consumption (Watts)	Percent Savings
202	105.1	56.1	41.62%
200	85.5	51.5	46.41%
190	80.0	50.5	47.45%
180	75.7	49.7	48.28%
170	70.6	48.6	49.43%
160	67.1	48.0	50.05%
150	63.2	47.1	50.99%
140	60.0	46.3	51.82%
130	56.6	45.7	52.45%
120	52.5	44.7	53.49%
110	49.2	44.1	54.11%

### 37LD650H/ LD655H

Item 099 Back Lighting (Static)	Picture Lumin.	Power Consumption (Watts)	Percent Savings
100	193.5	113.4	0.00%
90	178.5	106.5	6.08%
80	163.1	100.1	11.73%
70	149.0	93.8	17.28%
60	134.6	88.0	22.40%
50	118.9	81.5	28.13%
40	104.1	75.2	33.69%
30	89.1	69.2	38.98%
20	72.6	62.5	44.89%
10	57.1	56.1	50.53%
1	41.5	49.7	56.17%

Item 099 Back Lighting (Dynamic)	Picture Lumin.	Power Consumption (Watts)	Percent Savings
202	116.4	82.7	27.07%
200	94.1	72.1	36.42%
190	88.6	70.1	38.18%
180	83.1	67.7	40.30%
170	77.5	65.3	42.42%
160	71.9	63.0	44.44%
150	67.1	61.3	45.94%
140	61.4	59.0	47.97%
130	55.8	56.4	50.26%
120	50.2	54.1	52.29%
110	44.3	51.8	54.32%

### 42LD650H/ LD655H

Item 099 Back Lighting (Static)	Picture Lumin.	Power Consumption (Watts)	Percent Savings
100	212.8	144.1	0.00%
90	195.8	135.0	6.32%
80	177.9	125.7	12.77%
70	160.0	117.5	18.46%
60	143.7	109.1	24.29%
50	124.7	100.1	30.53%
40	107.6	91.8	36.29%
30	90.8	83.4	42.12%
20	72.6	74.2	48.51%
10	55.3	65.7	54.41%
1	39.4	57.5	60.10%

Item 099 Back Lighting (Dynamic)	Picture Lumin.	Power Consumption (Watts)	Percent Savings
202	109.8	98.2	31.85%
200	90.1	85.8	40.46%
190	84.2	82.8	42.54%
180	78.6	79.7	44.69%
170	72.5	76.6	46.84%
160	66.6	73.6	48.92%
150	62.2	71.2	50.59%
140	56.3	68.2	52.67%
130	50.7	65.2	54.75%
120	45.1	62.1	56.90%
110	39.5	59.8	58.50%

Note: Values are results of controlled experiments under laboratory conditions.



# Reference: Power Consumption Settings (Cont.)

**32/37/42LG710H**

**32LG710H**

Item 099 Back Lighting (Static)	Picture Lumin.	Power Consumption (Watts)	Percent Savings
100	206	104	0 %
90	204	103.5	0.48 %
80	203	103	0.96 %
70	172	93	10.58 %
60	147	85	18.27 %
50	127	79	24.04 %
40	108	73.5	29.33 %
30	86	67	35.58 %
20	66	60	42.31 %
10	50	55.5	46.63 %
1	39	51.5	50.48 %

Item 099 Back Lighting (Dynamic)	Picture Lumin.	Power Consumption (Watts)	Percent Savings
200	103	74	28.85 %
190	96	73	29.81 %
180	84	69.5	33.17 %
170	73	65.5	37.02 %
160	64	62	40.38 %
150	57	60	42.31 %
140	51	57.5	44.71 %
130	44	55	47.12 %
120	38	52.5	49.52 %
110	33	50.5	51.44 %
101	29	49	52.88 %

**37LG710H**

Item 099 Back Lighting (Static)	Picture Lumin.	Power Consumption (Watts)	Percent Savings
100	258	151.5	0 %
90	230	136.5	9.90 %
80	201	122.5	19.14 %
70	170	111	26.73 %
60	145	101.3	33.14 %
50	120	91.5	39.60 %
40	95	81.3	46.34 %
30	72	71	53.14 %
20	54	63.5	58.09 %
10	41	58	61.72 %
1	31	53	65.02 %

Item 099 Back Lighting (Dynamic)	Picture Lumin.	Power Consumption (Watts)	Percent Savings
200	93	91.5	39.60 %
190	79	85.5	43.56 %
180	67	80	47.19 %
170	58	74.8	50.63 %
160	50	70.8	53.27 %
150	44.5	67.5	55.45 %
140	38	63.5	58.09 %
130	31.5	59.3	60.86 %
120	27	56.5	62.71 %
110	23.5	54.5	64.03 %
101	21	52.8	65.15 %

**42LG710H**

Item 099 Back Lighting (Static)	Picture Lumin.	Power Consumption (Watts)	Percent Savings
100	286	185	0%
90	250	164.5	11.08 %
80	216	147.5	20.27 %
70	185.5	133.5	27.84 %
60	159	121.3	34.43 %
50	133.5	109.5	40.81 %
40	107.5	97	47.57 %
30	81	84	54.59 %
20	61	75	59.46 %
10	46.5	67.5	63.51 %
1	35	61.5	66.76 %

Item 099 Back Lighting (Dynamic)	Picture Lumin.	Power Consumption (Watts)	Percent Savings
200	113	109	41.08 %
190	108	103	44.32 %
180	96	96.4	47.89 %
170	83	89.7	51.51 %
160	73.8	84.5	54.32 %
150	65.2	80.2	56.65 %
140	55.8	75.2	59.35 %
130	46.13	69.9	62.22 %
120	39.6	66.1	64.27 %
110	34.4	63.5	65.68 %
101	29.85	61.4	66.81 %

Note: Values are results of controlled experiments under laboratory conditions.

# Reference: TV Camport Auto Sense Operation

The Camport Auto Sense function is enabled when:

1. Installer Menu item 034 CAMPORT EN is set to 1 AND
2. Installer Menu item 040 AUTO CAMPORT is enabled (1).

**Selectable:** Can be accessed with INPUT key, direct access, etc.

**Auto Sense:** TV switches to this input when connector is inserted. The Camport (Side Video) has the highest priority and will override any commands including tuning to the Start Channel.

## CAMPOR (Side Video) Functionality Control

Item 034 CAMPORT EN	Item 040 AUTO CAMPORT	Side Video Operation
0	0	Disabled
0	1	Disabled
1	0	Selectable
1	1	Auto Sense

### Campport Operation (Stand-Alone)

When Camport Auto Sense is enabled as above, the TV's source will switch to the Side Video Aux source whenever a plug is inserted into either of the Side Video panel inputs (Composite Video or S-Video).

When the plug is removed, the TV will switch back to the previous channel or input source that was being displayed before the plug was inserted. However, if any direct access to an RF channel or Aux channel is requested while the Camport is active, then, when the video plug is removed, the TV will switch to the last requested channel. Source changes using any Source keys (INPUT) are ignored. Channel Up/Down and Flashback commands are not direct access tuning commands, and they are also ignored.

Previous State Before Inserting CAMPORT	Operation While CAMPORT is Active	State Upon Removal of CAMPORT
Aux or RF Channel	None	Previous Aux or RF Channel
Aux or RF Channel	Direct Access	Last Requested Aux or RF Channel
Aux or RF Channel	Ch Up/Down, Flashback, and Input Keys	Previous Aux or RF Channel

### Campport Operation (FTG or PPV)

The operation will be similar to that of the Stand-alone Mode. However, when the Channel Map is maintained external to the PTC (i.e., FTG and PPV), Channel Up/Down or Flashback keys are sent as Direct Access tuning commands to the PTC/TV.

Previous State Before Inserting CAMPORT	Operation While CAMPORT is Active	State Upon Removal of CAMPORT
Aux or RF Channel	None	Previous Aux or RF Channel
Aux or RF Channel	Direct Access	Last Requested Aux or RF Channel
Aux or RF Channel	Ch Up/Down, Flashback, and Input Keys	Last Requested Aux or RF Channel

## Reference: TV Aux Input Configuration

DIRECT ACCESS Tuning		TV		ENABLE				MPI DATA			START AUX SOURCE ASSIGNMENT
				Installer Menu		MPI DATA STATUS TYPE 0x41 SOURCES ENABLED (R/W)		DATA STATUS TYPE 0xD2 CURRENT AV SOURCE (R)		DATA STATUS TYPE 0x0D AUX SOURCE (R)	
OLD_OCV = 0	OLD_OCV = 1	Source Input	Source Mode	Number	Labeling	Value	Labeling	Value	Labeling		
130	90	Video2 (Side)	CV/SVIDEO	34	CAMPOR_T_EN	0x01	Video Front (Campor_t)	0	Video Front (Campor_t)	0 (VIDEO)	2
131	91	Video1 (Rear)	CV/SVIDEO	39	REAR_AUX_EN	0x02	Rear Video (Aux)	1	Rear Video (Aux)	0 (VIDEO)	1
132	92	HDMI2	DTV/PC	91	YPrPb2 EN = 1	0x04	S-Video Rear	2	S-Video Rear	0 (VIDEO)	5
133	93	HDMI1/DVI	DTV/PC	35	COMPPOR_T_EN = 1	0x08	Front Computer	3	Front Computer	0 (VIDEO)	3
134	94	RGB	PC	87	REAR RGB EN = 2	0x10	SVGA Rear Computer	4	SVGA Rear Computer	2 (COMPUTER)	4
136	96	Component		38	YPrPb EN	0x40	Y/UV Component	6	Rear Y/PrPb Component Video	0 (VIDEO)	6

## Reference: *b*-LAN Setup & Overview

The *b*-LAN module is internal to the TV. It allows the hotel/institution head end equipment to communicate, via the institution's RF distribution system, with the TV for configuration and control. The *b*-LAN module also comprises the data tuner required for Pro:Centric operation.

**Note:** MPI cards with *b*-LAN technology—LMT7Z5, LMT7Z7, LMT7Z9—are NOT supported on TVs in which the *b*-LAN module is embedded.

Power to the *b*-LAN module is controlled by Installer Menu item 118 POWER SAVINGS. The default value is 003—the *b*-LAN module is only powered when the TV is turned ON. See chart below.

POWER SAVINGS	TV Standby State	TV Power On State
	<i>b</i> -LAN Power	<i>b</i> -LAN Power
001	On	On
003 (default)	Off	On
007	Off	Off

The control device at the head end, for example, an FMA-LG101 or a PCS100R, can control multiple TVs. When the TV is first installed, it must be turned ON in order for the head end to be able to communicate with the *b*-LAN. At this point, if it is desired for the *b*-LAN to always be powered, including while the TV is in Standby, set Installer Menu item 118 POWER SAVINGS to 001.

If the embedded *b*-LAN, including the Pro:Centric data tuner, will not be used, enable maximum power savings in both Standby and TV Power On Mode by setting Installer Menu item 118 POWER SAVINGS to 007. However, note that this action will disable Pro:Centric operation.



**Warning for LD650H/LD655H TVs: If an MPI card is installed, POWER SAVINGS must be set to 001. See table below. (Also see note regarding MPI cards at the top of the page.)**

POWER SAVINGS	32/37/42LD650H/LD655H MPI Slot
001	Supported
003 (default)	Not Supported
007	Not Supported

# Reference: RJP Model List and Input Auto-sensing Hierarchy

---

## RJP Model List

<b>Legacy Models</b>	<b>Scaler Models</b>
RJP-101M	N/A
RJP-101ML	N/A
RJP-110F	RJP-210F
RJP-110FW	RJP-210FW
RJP-110W	RJP-210W
RJP-110WBR	RJP-210WBR
RJP-110S	RJP-210S
RJP-120G	RJP-220G
RJP-120T	RJP-220T
RJP-201B	RJP-301B
RJP-202B	RJP-302B

## RJP Input Auto-sensing Hierarchy

<b>Priority</b>	<b>Video</b>	<b>Audio</b>
1st (Highest)	Digital Video In	Audio In (3.5mm)
2nd	PC Video In	Audio In (L/R)
3rd	Video In	Digital Video In

# Troubleshooting

## General Troubleshooting

---

### Some Quick and Easy Tips for Resolving Problems

Symptom	Possible Cause(s)	Possible Solution(s)
<b>Software Problems</b>		
Cannot direct enter channel number or "No Signal" appears.	Channel not included in channel lineup in TV controller.	After 2-5-5 + MENU, only channels included in TV controller will appear. If channel is available, it can be added to channel lineup. If it is not available, the "No Signal" message appears on the TV screen.
<b>Power</b>		
No power.	See troubleshooting flowchart on following page.	
<b>Display Panel Picture</b>		
No picture.	Display panel is turned off.	<ul style="list-style-type: none"><li>• Turn TV ON.</li><li>• Power failure?</li></ul>
	Antenna/cable not connected.	Connect antenna/cable signal to TV.
	Connections incorrect.	Check connections on TV.
	MPI not connected.	If applicable, connect MPI cable to MPI device.
	Encrypted program.	Try another channel.
Wrong tuning band.	Adjust Installer Menu settings.	
<b>Erratic Operation</b>		
Installer Menu setup.	Wrong Installer Menu settings.	Adjust Installer Menu settings as required.
<b>Installer Remote</b>		
Remote doesn't work.	Remote not in TV Mode.	Use MODE key to select "TV"; puts remote into TV Mode.
	Not aimed at IR remote sensor.	Point remote at TV's IR receiver on TV.
	Remote too far from IR sensor.	Move remote closer to TV's IR receiver or darken room.
	MPI not connected.	If applicable, connect MPI cable to MPI device.
	IR path to TV's receiver obstructed.	Remove obstructions.
	Weak batteries.	Replace batteries.
	Wrong battery polarity.	Check that "+" and "-" match in battery compartment.
	Too much light in room.	Dim room light.
Wrong Installer Remote.	Requires compatible Installer Remote. Contact your LG dealer.	
<b>Picture Reception</b>		
Normal picture, poor or no sound.	Audio muted.	Press MUTE or use Volume Up key to increase sound level.
	Broadcast problem.	Try a different channel.

**Note:** For other problems not caused by the TV, refer to the other devices' operating guide(s).

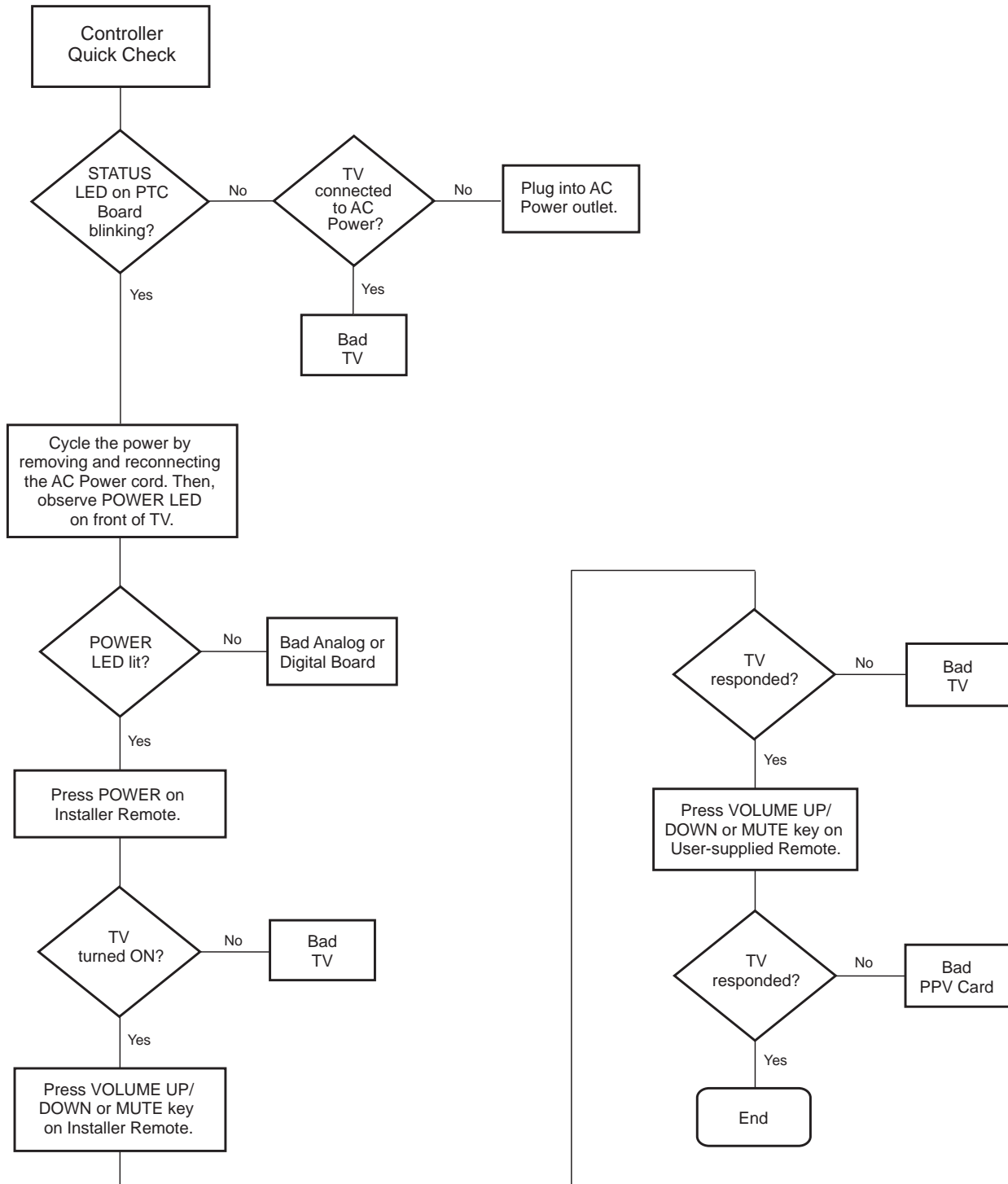



# Troubleshooting (Cont.)

## Commercial Mode Check / FTG Operation Troubleshooting

---

### Commercial Mode Check

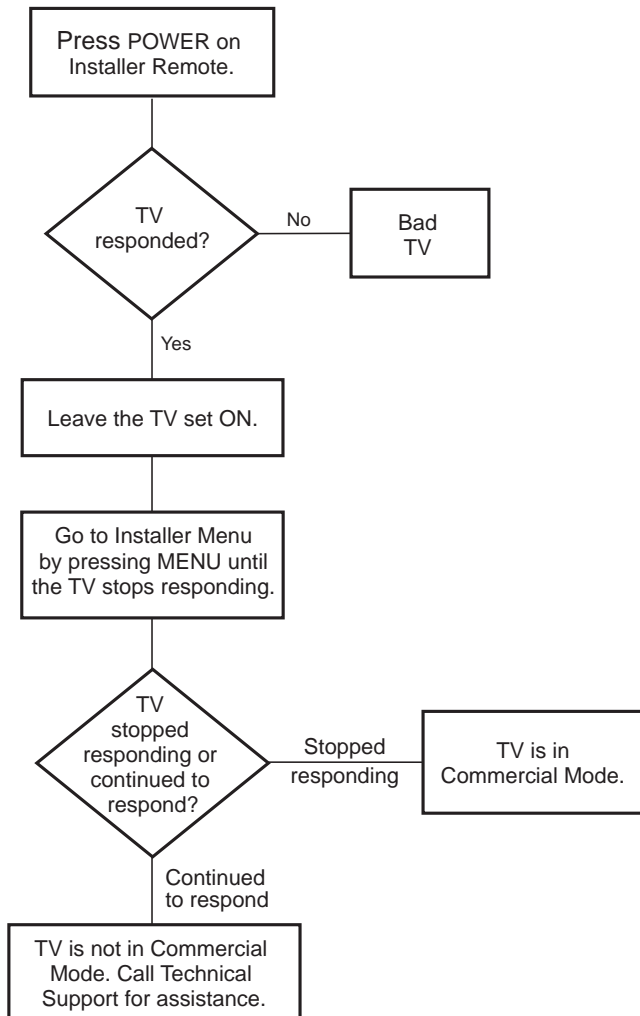

### FTG Operation Troubleshooting

The following table provides troubleshooting information for when the EBL is configured in the FTG Mode of operation.

Symptom	Possible Cause(s)	Solution(s)
Communication Error ("Communications Timeout")	Cable(s) not connected.	Check and connect communication cables.
	TV not powered.	Check/connect the TV power cord.
	TV not turned ON.	TV needs to be turned ON (default FTG Mode).
	Wrong COM (communication) port.	In the FTG Configuration Application, select the correct COM port for the cable being used.

## Clone Programmer Troubleshooting

 **Warning: Do not connect a clone programmer to any PPV card installed in the Master TV or any MPI port while the TV is in PPV Mode, or the clone programmer and the PPV card will be damaged.**

### Reset Clone Programmer After Static Shock

After replacing exhausted batteries (LT2002 only), or if the clone programmer behaves strangely after a static shock:

- TLL-1100A: Turn the TLL-1100A OFF and then ON.
- LT2002: Use a paper clip or similar instrument inserted through the small hole marked RESET to activate the internal reset switch and restore normal operation.

After a reset, check the real-time clock setting. It may be necessary to reset the clone programmer clock from a TV containing the correct time.

### Note

The TLL-1100A and LT2002 clone programmers are designed to be used with TVs containing the 221-01006 and later processors. Use with earlier TVs may give unpredictable results. Processors used before the 221-01006-04 have a limited screen display capability. They cannot display entire screens as shown in the setup instructions accompanying the clone programmer. Use the printed menu illustrations in the documentation supplied with the clone programmer as an aid to making your programming choices.

Symptom	Possible Cause(s)	Possible Solution(s)
<b>Clone Programmer</b>		
Clone copies setup in less than 30 seconds.	Not enough time to copy entire TV setup.	TLL-1100A: Turn the TLL-1100A Off and then ON. LT2002: Press RESET on clone programmer. Then redo Learn/Teach. (Learning usually takes about 90 seconds; Teaching usually takes 3 to 4 minutes.)
Remote does not operate clone programmer.	Wrong Installer Remote.	Only use an LG Installer Remote to operate clone programmer with TV.
Clone menu does not display on TV screen, TLL-1100A shows error message, or LT2002 LED does not blink.	MPI cord not connected. TV not turned ON. (LT2002 only) Weak batteries. (TLL-1100A only) No charge.	Connect MPI cord properly, and ensure good connection. TV must be powered ON for clone programmer to work. Install four (4) fresh AA high-quality alkaline batteries. Ensure the TLL-1100A is fully charged or connected to AC power.
Clone menu hard to read.	Weak signal.	Connect TV to a reliable analog channel signal source.
No time set.	Time not available.	Set time on a TV, and copy time to clone programmer.
Clone not working.	Clone programmer problem.	Try a different clone programmer. Reset the clone programmer.
Clone scans channels more than once.	Clone should only scan channels once.	Ensure TV is set up correctly, and try cloning again.

### Master and Target TVs

Cloning did not work.	Procedure interrupted.	Wait until procedure complete message is displayed.
	Different TV models. Step(s) omitted or not performed.	Cloning is only possible with identical model TVs. Refer to the applicable cloning procedure(s), and make sure all tasks were performed.
(LT2002 only) Clone time disappeared.	Batteries were removed.	Batteries must remain installed to retain time settings.
New setup not present.	Target TV not reset.	Disconnect Target TV from AC power for fifteen (15) seconds.

- After cloning operations are complete, unplug the TLL-1100A/LT2002 from the TV.
- If the TV does not display a picture on the TV (blank screen) after a few seconds, just change channels.

# Glossary of Terms

---

A list of definitions for some of the words found in this guide.

## **75 OHM RF CABLE**

The wire that comes from an off-air antenna or cable service provider. The end looks like a hex-shaped nut with a wire through the middle. It screws onto the Antenna/Cable threaded jack on the back of the TV.

## **300 TO 75 OHM ADAPTER**

A small device that connects a 2-wire 300 ohm antenna to a 75 ohm RF jack. It is usually about an inch long with two screws on one end and a round opening with a wire extending out the other end.

## **A/V CABLES**

Audio/Video cables. Three cables bunched together—right audio (red), left audio (white), and video (yellow). A/V cables are used for stereo playback of videocassettes and for higher quality picture and sound from other A/V devices.

## **A/V DEVICE**

Any device that produces video or sound (VCR, DVD, cable box, or television).

## **AMPLIFIER**

An electronic device that amplifies sound from a television, CD player, VCR, DVD, or other Audio/Video device.

## **ANTENNA**

The physical receiver of television signals sent over the air. A large metal piece of equipment does not always have to be visible to be using an antenna.

## **b-LAN**

Licensed proprietary RF communication system used to configure/control TV via RF distribution system.

## **CABLE**

Cable service box. Refers to the descrambler box cable subscribers use to receive cable programming signals.

## **CATV**

Programming provided by a cable service.

## **COMPONENT VIDEO**

Uses three wires for transporting three-color video signals. The end result is usually better video quality.

## **COMPOSITE VIDEO**

Typical video jack, uses one wire for transporting three-color video signals.

## **DELETE**

Lets you remove channels from the list that the end user can scroll through using Channel Up/Down.

## **DIGITAL TELEVISION**

High-resolution, cinema-quality television signals transmitted digitally.

## **DVI**

Digital Video Interface. Accommodates analog and digital interfaces with a single connector.

## **HDMI**

High-definition multi-media interface.

## **HDSTB**

High-definition set top box. Refers to a tuner device that receives high-definition television signals which have higher resolution than ordinary analog TV signals.

## **HDTV**

High-definition television. Refers to television signals that have higher resolution than ordinary analog TV signals.

## **INPUT**

Refers to the input jack that receives a signal from a TV, VCR, DVD Player or other Audio/Video device.

## **JACK**

An input or output connector on the back of a TV, VCR, DVD Player or other Audio/Video device.

## **MONO SOUND**

Mono (monaural) sound is one channel of sound. On more than one speaker, all the speakers play the same audio.

## **OUTPUT**

Refers to the output jack that sends a signal out of a VCR, DVD, or other A/V device.

## **PHYSICAL CHANNEL NUMBER**

The actual channel number. Analog channels use the Physical Channel number and digital channels can use a Virtual Channel number.

## **RGB (RED, GREEN, BLUE)**

Connection input or output port available for producing a video image using three separate colors: Red, Green, and Blue.

## **RS-232**

Serial communication port through which firmware is downloaded.

## **2ND AUDIO PROGRAMMING/SAP**

Second Audio Programming (SAP) is another, separate audio channel available with some programming. Choosing SAP often refers to listening to audio in another language, such as Spanish or French.

## **SIGNAL**

Picture and sound traveling through a cable, or over the air, to the TV.

## **STEREO SOUND**

Stereo (Stereophonic) sound refers to audio that's divided into right and left sides.

## **TUNER**

Device that picks up the broadcast signal and turns it into picture and sound.

## **VIRTUAL CHANNEL NUMBER**

A re-mapped channel number. Analog channels use the Physical Channel number; however digital channels use a Virtual (or false) Channel number.

## **XDS**

Extended Data Service (XDS) is additional program information included on the signal provided at the discretion of the broadcaster.

---

Note: Refer to [www.atsc.org](http://www.atsc.org) for further information.

## Document Revision History

<b>Date</b>	<b>Description</b>
August 2010	Revision A: New document
October 2010	Revision B: Power Savings updates for LD65xH TVs; troubleshooting update

Product documentation is available online at: [www.LGolutions.com/products](http://www.LGolutions.com/products). From the Products page, select **TVs, Systems & Solutions**, then **LCD TVs**, then the applicable TV. Click the **Literature & Downloads** tab at the bottom of the TV page, and select the required document(s) from the Downloads list.

---

## Notes



---

For Customer Support/Service, please call:

**1-888-865-3026**

[www.LGsolutions.com](http://www.LGsolutions.com)

Pro:Idiom is a registered trademark of Zenith Electronics LLC. Pro:Centric is a trademark of LG Electronics U.S.A., Inc. *b*-LAN is a trademark of LodgeNet Interactive Corporation. All other trademarks or registered trademarks are the property of their respective owners.