

2023

MULTI V™

LG AIR SOLUTION



INDEX

OUTDOOR UNITS

026

MULTI V <i>i</i>	028
MULTI V S	064
MULTI V M	086
MULTI V WATER 5	096



114

WALL MOUNTED	116
CEILING MOUNTED CASSETTE	130
CEILING MOUNTED ROUND CASSETTE	150
CEILING CONCEALED DUCT	154
FRESH AIR INTAKE	167
CEILING & FLOOR CONVERTIBLE CEILING SUSPENDED	170
CONSOLE & FLOOR STANDING	176
FLOOR STANDING (PAC)	183
COMPATIBILITY & FEATURE FUNCTIONS	186

INDOOR UNITS



HOT WATER SOLUTION

190

HYDRO KIT	192
-----------	-----



198 VENTILATION SOLUTIONS

ERV	200
ERV WITH DX COIL	208
RESIDENTIAL ERV	210



CONTROL SOLUTIONS



214

INDIVIDUAL CONTROL	220
CENTRALIZED CONTROL	232
INTEGRATION DEVICE	258



ACCESSORIES

294

MECHANICAL ACCESSORIES	296
PIPING ACCESSORIES	304

MARKET TREND IN EU

More efficient HVAC systems are required to significantly reduce energy consumption and to meet energy regulations.



Soaring Energy Prices in Europe

- Climate change increases the need for more efficient mechanical HVAC systems and energy usage
- Electricity and gas prices are constantly rising for a number of reasons, such as growing energy demand, taxes, oil prices, wars, etc

Electricity & Gas price

Wholesale Prices EU27

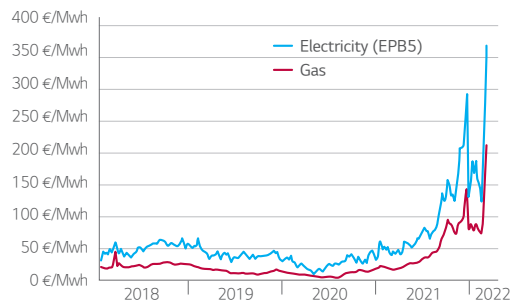

Source : brusselstimes



Efficiency

- Global warming in Europe is faster than the rest of world according to the IPCC
- AI, big data, 5G, Cloud technologies upgrade human lifestyle innovatively
- For a comfortable environment, humidity has to be considered



Increase of average yearly temperature in selected cities in Europe (1900-2017)



Environment

- The EU reinforces its efforts to stimulate energy efficiency as part of its 2050 decarbonization objectives
- HVAC composes more than 50% of a building's energy consumption

Low-carbon Strategy (Targets compared to 1990) levels

- Cutting emissions by at least 55% by 2030.
- EU targets a minimum reduction of 80% in carbon emissions by 2050.

	2005	2030	2050
Power (CO ₂)	-7%	-54% ~ -68%	-93% ~ -99%
Industry (CO ₂)	-20%	-34% ~ -40%	-83% ~ -87%
Transport (incl. CO ₂ , aviation, excl. maritime)	+30%	+20% ~ -9%	-54% ~ -67%
Residential & Services (CO ₂)	-12%	-37% ~ -53%	-88% ~ -91%
Agriculture (other than CO ₂)	-20%	-36% ~ -37%	-42% ~ -49%
Total	-7%	-40% ~ -44%	-79% ~ -82%

* Source : European Commission





MULTI V BRAND HISTORY

MULTI V is recognized for its technology and innovativeness.

AI Engine **NEW**

MULTI V™ i

Superior customer experience with AI Technology

*i*nnovative

*i*ntelligent

*i*nteractive

Dual Sensing

MULTI V™ 5

Efficiency and Comfort with dual sensing control

All Inverter



HISTORY OF MULTI V LEADERSHIP

2013

MULTI V™ IV

- Active Refrigerant Control
- Variable Heat Exchanger Circuit
- Smart Load Control
- Smart Oil Return
- Vapor Injection (Advanced)

2017

MULTI V™ 5

- Dual Sensing Control
- Ultimate Inverter Compressor
- Large Capacity ODU with Biomimetic Technology Fan
- Continuous Heating
- Ocean Black Fin

2023

MULTI V™ i

- Energy Saving with AI engine
- Noise adaptive outdoor unit
- Smart Diagnosis Reporting
- Remote Upgrade System
- Weather reference operation

INFRASTRUCTURE IN EUROPE



LG Air Conditioning Academy

LG has set up 20 official air conditioning academies in Europe, teaching much needed skills to thousands of current industry professionals including installers, consultants, designers, sales staff and service technicians. The academy program is being used to share expertise and educate these HVAC experts by providing a cutting-edge technical experience with the newest and most advanced technologies and equipment. Moreover, as LG's entire product range is installed on site, professionals can be trained in a realistic way that offers them the chance to experience the latest products first-hand.



European Air Conditioning Distribution Center

LG's European Air Conditioning Distribution Center is located in Oosterhout, the Netherlands. Supplying and delivering products all over Europe, this distribution hub has contributed to smooth and rapid delivery, direct shipping for smaller orders and delivery tailored to air conditioners. The hub tries to manage inventory efficiency by taking advantage of LG EU's established inventory pool.

-  Air Conditioning Academy
-  Europe Energy Lab
-  European Distribution Center

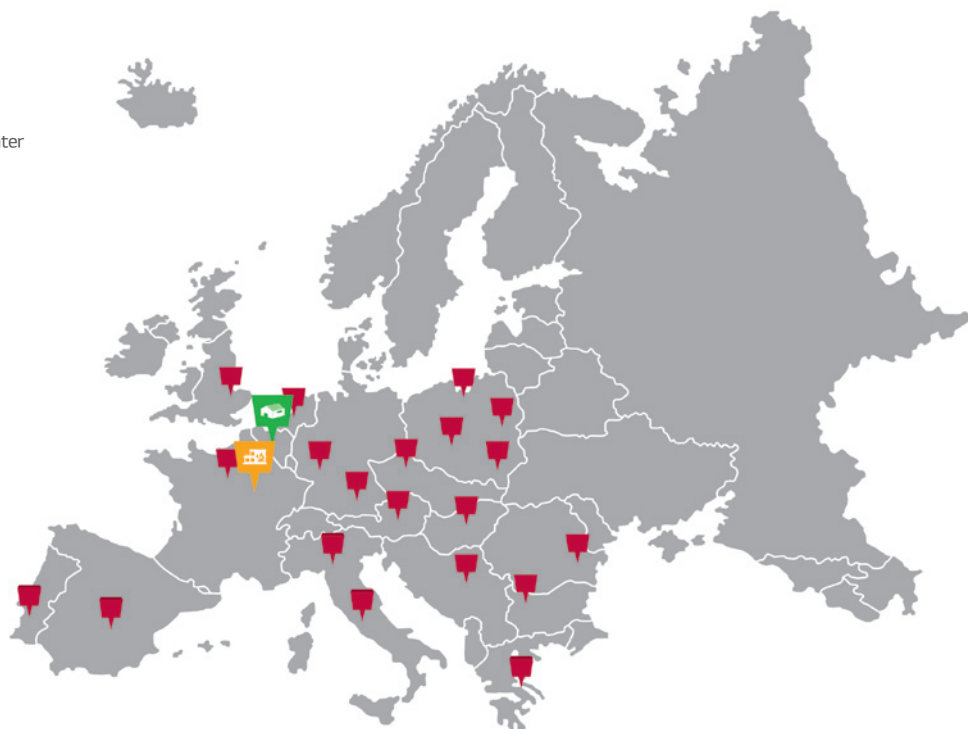

ENGINEERING TOOLS & SUPPORT

From planning to service & maintenance and then to de-construction, an architectural project goes through many stages from the beginning to the end of its lifecycle. Along those stages, various engineering tools are applied to solve the diverse issues happening in each stage, with the most optimal solution possible. Given the usage of such tools, buildings are effectively designed, built, supervised, and maintained throughout their lifecycle.

Dedicated to provide the best HVAC engineering support, LG Electronics Air Solution Business Unit offers several engineering tools and solutions focused on HVAC, during the overall lifecycle of a building, related to the three categories. Among them, the LATS* Program series has been developed to offer the best tool for LG HVAC systems, providing our customers with a solution that allows for faster, easier and more accurate model selection, draft energy estimations and more.

* LATS : LG Air-conditioner Technical Solution

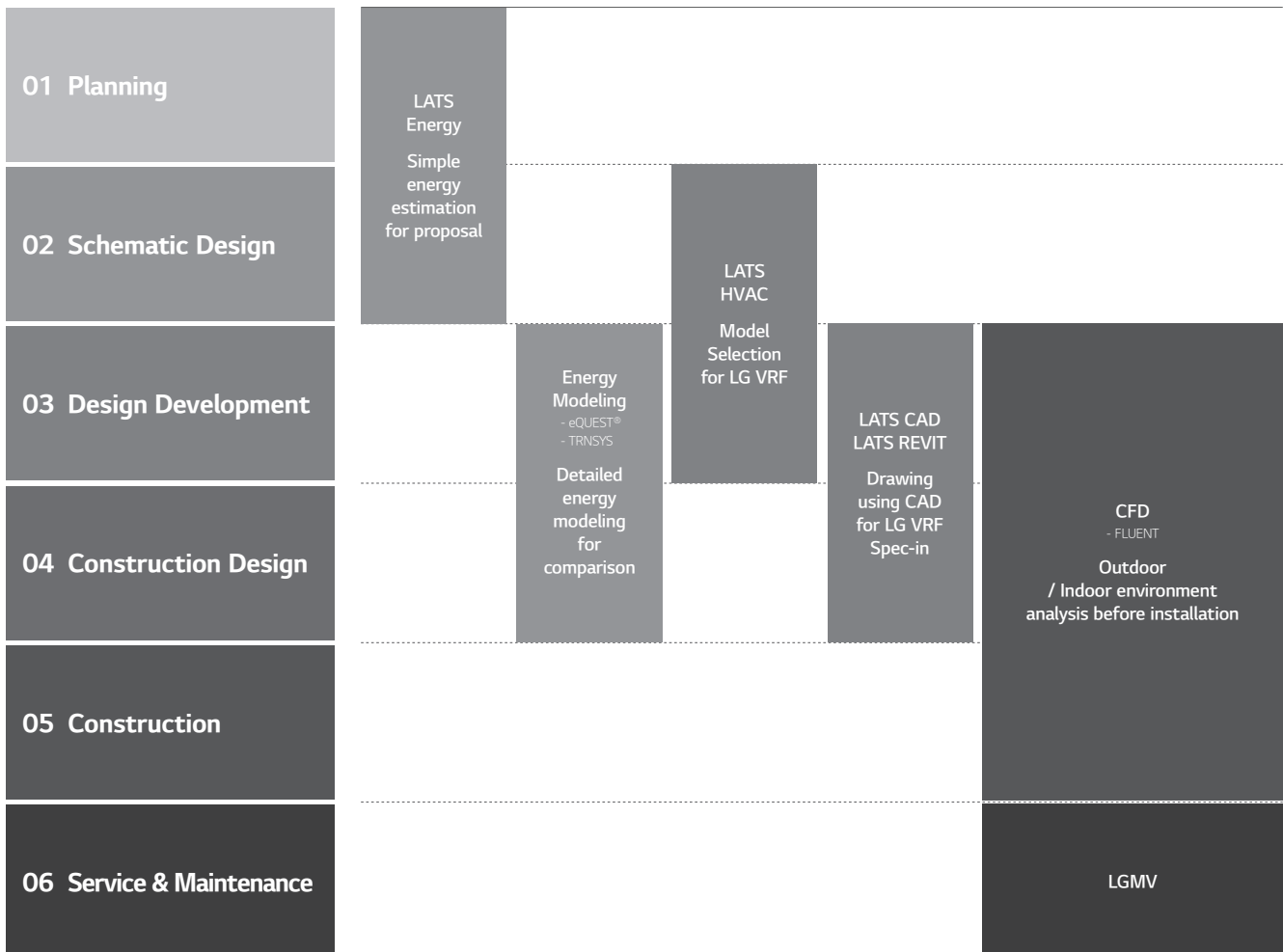
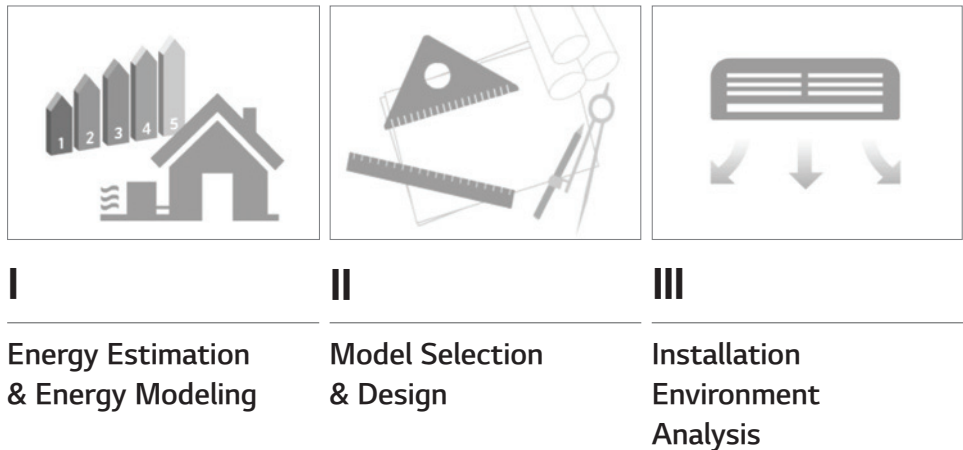

01 Draft Energy Estimation

LATS Energy

LATS Energy is a program developed by LG to estimate energy consumption and analyze the life cycle cost of LG commercial air conditioning systems at early stages of a project.

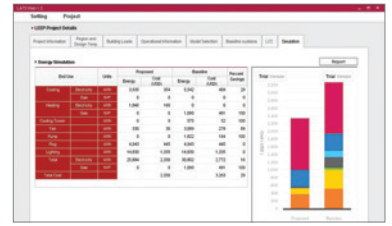

02 Building Energy Modeling

eQuest, EnergyPro, Trace700 and More

These are certified commercial programs which assess the HVAC system efficiency and building's annual energy savings for building standards or certifications, like LEED. LG HQ supports these programs for the project stages of Design Development and Construction Design wherein the overall designing is finished.

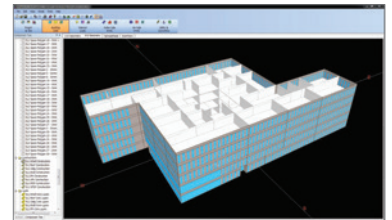

03 Model Selection

LATS HVAC

LATS HVAC is a model selection program that accurately and quickly selects the most suitable LG commercial air conditioning systems for each design. In addition to model selection, faster estimation on refrigerant piping diameter and additional refrigerant is possible, along with auto printing of reports.

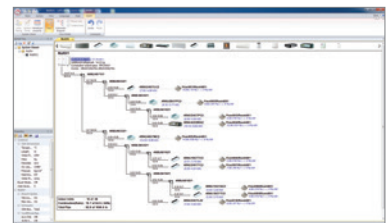

04 Design

LATS CAD

LATS CAD enables faster and more accurate 2D design of LG commercial air conditioning systems. It also enables modules for quotation and installation review that minimize inherent problems during installation and commissioning.

※ AutoCAD program is required.



LATS REVIT

LATS REVIT allows BIM users to have an attractive 3D design of LG commercial air conditioning systems with embedded calculations for refrigerant and efficiency features.

※ AutoCAD Revit program is required.

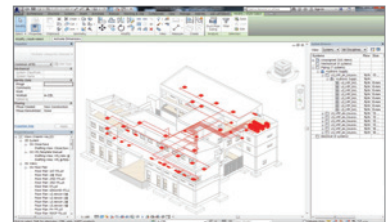

05 Environment Simulation

CFD Analysis

CFD Analysis is applied to estimate indoor airflow and temperature distribution while operating VRF products, outdoor airflow distribution, and noise level.

By running a simulation before construction, engineers estimate potential issues and find optimal solutions for malfunctions that could occur after construction.

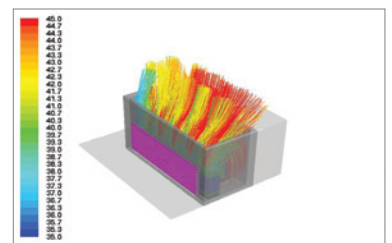

06 Service & Maintenance

LGMV

LGMV offers real-time MULTI V cycle monitoring. During start-up, LGMV can check for normal operation as well as troubleshoot any errors. Also it helps to find causes of errors and solve the problem faster.



BENEFITS OF LG MULTI V

Benefits for Building Owners



Efficient Management & Cost Reduction

- Fault Detection Diagnosis enables easy maintenance & no extra manpower for regular maintenance
- Saves space, time, and installation costs by offering a larger capacity single outdoor unit
- More reliable heating operation provides stable and powerful heating condition at the unexpected extreme environment



Reliability at Every Stage

- Ultimate Inverter Compressor developed and manufactured in Korea
- Corrosion resistant Black Fin & Panel for harsh conditions operation



Customized Comfort and Solution

- Preset monthly energy usage and consume power according to the target that has been previously set



Benefits for Developers & Construction Companies



Green Solutions

- More environmentally friendly system & higher energy efficiency, less carbon emission with Hydro kit



Maximizing Space Utilization

- Large capacity in compact size enhances space utilization



Smart Building Solutions

- Seamless integration with current Building Management Systems
- User friendly interface, flexible interlocking environment, energy management and smart individual controller for optimized controlling conditions and smart building management
- Expandable control system can makes building management smart by setting up logic optimized for the site



Benefits for Consultants



Versatile Solutions

- Air-cooled, Water-cooled, Heating, ERV, and Air Handling Unit interlocking solutions



Professional Design Support

- LATS (LG Air-conditioner Technical Solution) for draft energy estimation, model selection, HVAC design and 3D designing
- CFD Analysis to ensure suitable solutions and prevent malfunctions
- Energy simulation offered to find the optimal solution



Optimized Convenience with HVAC Design

- Flexible combination provides more options for designing according to customers' preferences
- The outdoor unit noise can be restricted by the set noise level in advance



Benefits for End-users



Cost Saving Operation

- High efficiency guaranteed throughout product line-up
- Prevent overuse of the HVAC system operational costs by AI Energy management



Comfort Cooling & Heating

- MULTI V *i* is able to take control by itself in various situations through deep learning algorithms that enable it to self-learn
- Automatic operation provides more comfort and convenience by checking ambient weather conditions



Convenient Functions

- Low-noise operation provides a pleasant environment



APPLICATION SOLUTIONS

Office

Supporting efficiency with flexibility

High Rise Office Building



- MULTI V WATER 5 (with variable water flow control kit)
- DX AHU
- High Static Duct
- PDI**
- ACP 5

Small to Medium sized Office Building



- MULTI V i / S
- Dual Vane 4 Way CST* / 4 Way CST*
- ERV

The MULTI V series revitalizes the workspace by providing fresh air at all times. LG's intelligent control solutions add comfort to any space.

Commercial

Maximizing business, minimizing cost

Shopping Mall



- MULTI V i
- DX AHU
- Duct

Retail



- MULTI V i / MULTI V M
- ERV
- Convertible
- Duct

Quick Service Restaurant (QSR)



- MULTI V M
- ERV
- Hydro Kit
- 4 Way CST* / Duct

The highly efficient, energy saving MULTI V i and MULTI V M reduce operation costs and provide comfort to suit any purpose and any interior, helping your business save extra space and reduce expenses.

* CST : Cassette ** PDI : Power Distribution Indicator

Residential

Creating a comfortable home

Condominium & Apartments



Single Family House & Villa



Remarkably compact size and high static pressure of MULTI V S enables optimal space solution, providing comfort to every space through individual zone control and hot water solution.

Hospitality

Meeting diverse needs

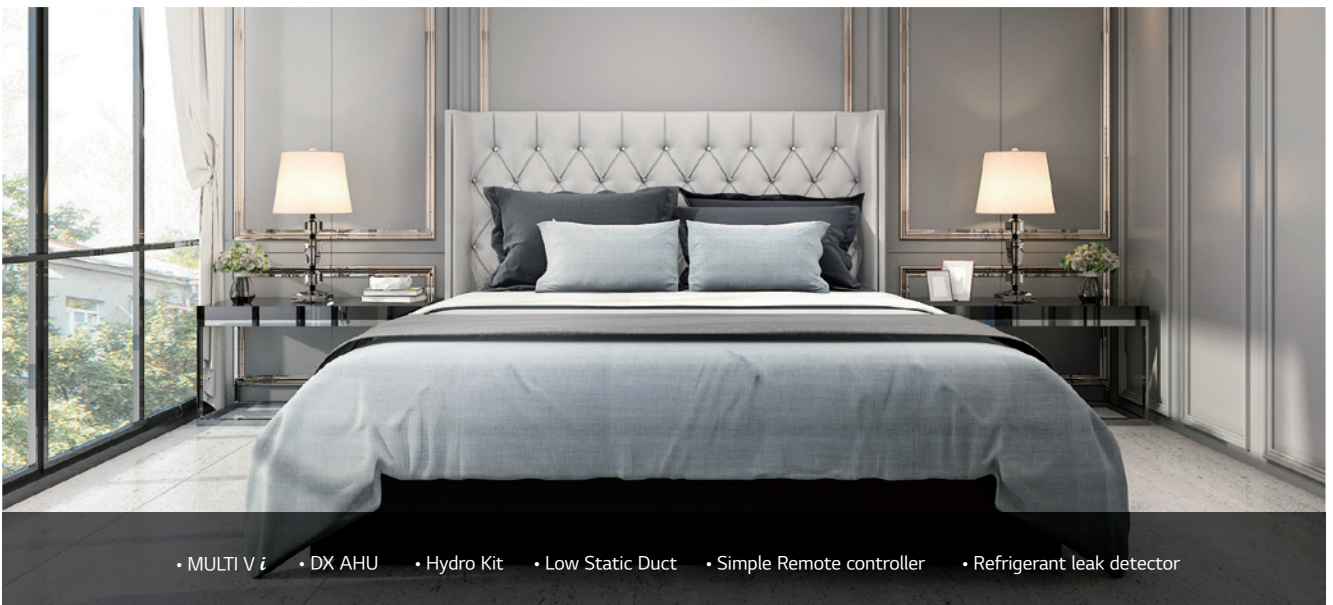

The variety of applications that MULTI V i offers represents a perfect opportunity for sophisticated hotel business.

* ESS : Energy Storage System

Hot Water Solution

MULTI V *i* with Hydro kit provides floor heating and hot water supply as well as space heating & cooling. It is a more environmentally friendly system with higher energy efficiency and less carbon emission.



* MT = Medium temp. 50°C LWT
 ** HT = High temp. 80°C LWT

Interlocking Operation with ERV

LG ERV DX with humidification function interlock operation is a solution for humidifying and ventilating the indoor space while communicating with other IDUs and the ODU. They provide improved comfort conditions considering the indoor conditions without additional facility installation.

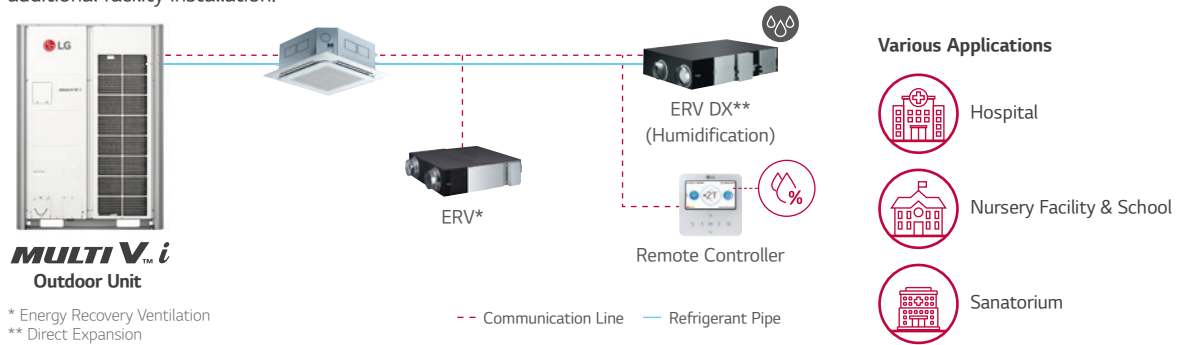

* Energy Recovery Ventilation
 ** Direct Expansion

Air Handling Unit (AHU) Solution

AHU is a suitable solution for cooling and heating in large spaces. With an LG AHU Comm. Kit (for both return air / supply air control) connected to the DX coil of the AHU, LG VRF system can be applied to deliver conditioned air.

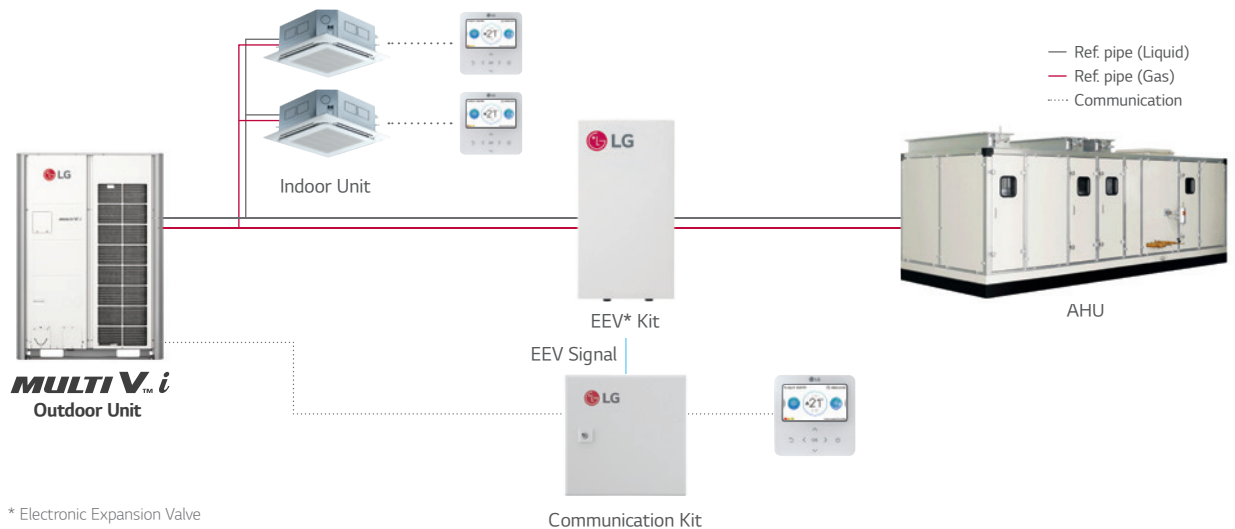

* Electronic Expansion Valve

Refrigerant Leak Detection Solution

LG leakage detector keep the indoor space safe and guarantees the customer's peace of mind.

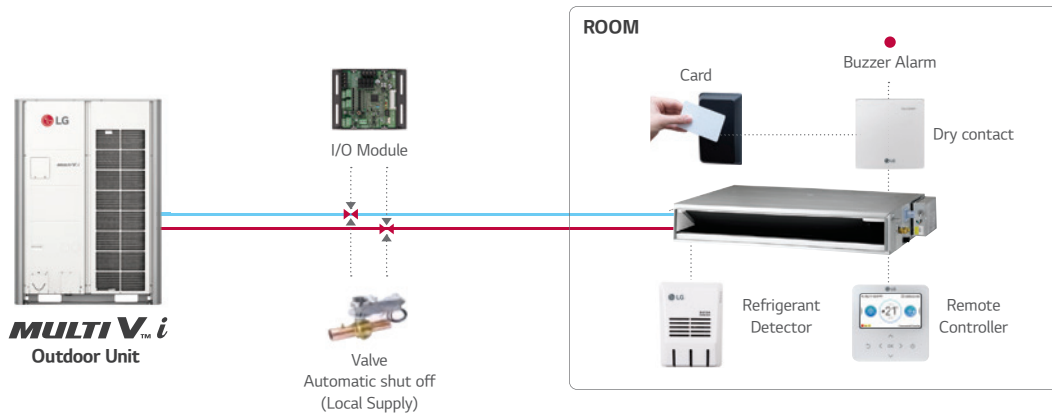

Power Consumption Distribution Solution

In case of shared power consumption in a building, a solution to distribute the power consumption amount per tenant might be necessary. Electricity charges can be billed to each tenant by using output from the LG Power Distributor Indicator (PDI). An administrator is able to check the power usage for each space and date as needed. If the PDI is used in conjunction with an LG central controller, the results can be exported in excel format.

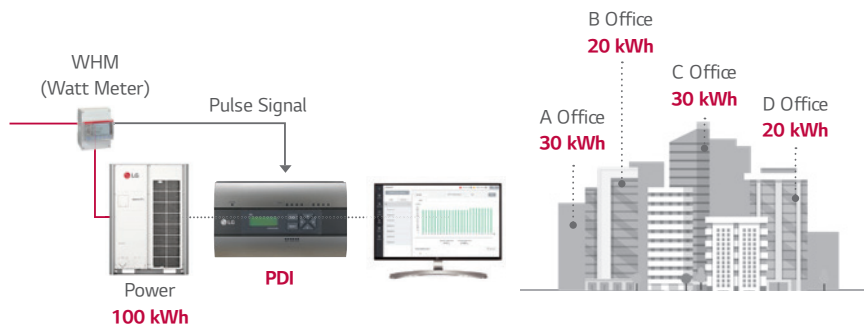

Total Control via Any Device

When managing multiple spaces, building administrators should be able to control systems from wherever they are. The LG central controller can be accessed from any web browser that supports HTML5. The interface has been adapted to look great and perform well on any device.



Energy Management Solution

Energy navigation function allows LG MULTI V i to preset monthly energy usage and consume what has been previously planned. By comparing and analyzing previous consumption and planned energy usage for the month, overuse of the HVAC system operational costs can be prevented with central controller.

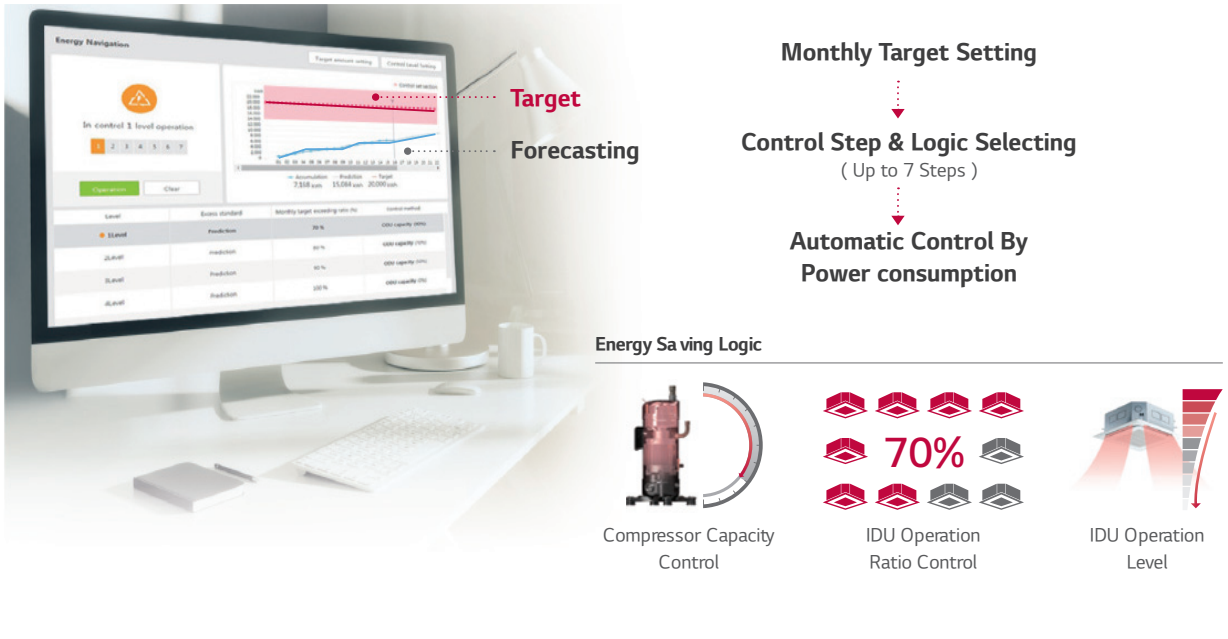

Integration Solution with BMS

There are many BMS protocols used for the control of buildings' various systems such as HVAC, lighting, power and security. LG has a wide range of gateway products for different protocols such as BACnet, Modbus, and LonWorks. In addition, LG gateways include Stand-alone central control capability to act as a back-up controller of the BMS if needed.



BMS System

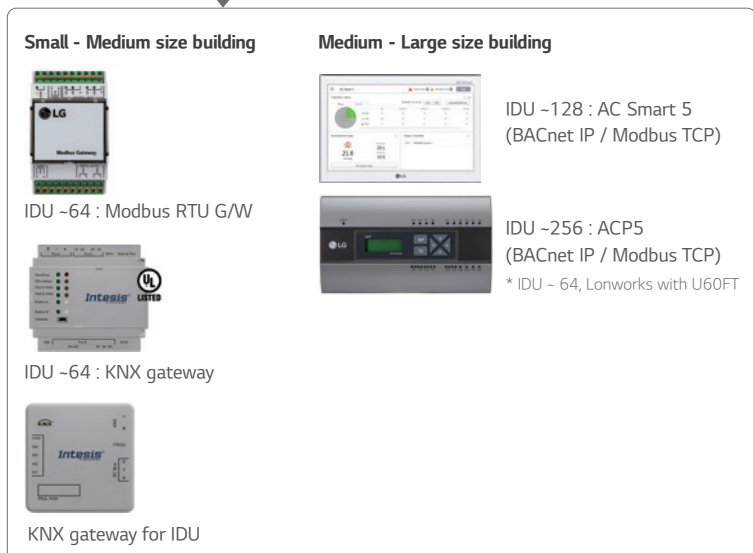

Interlocking Solution by Using ACU Module

It is costly to introduce a BMS system to control multiple devices or systems in a small building. With the ACU module, various IO contact points (DI, DO, UI, AO) can be interlocked and integrated, while control is possible from the LG central controller. This enables an efficient management of lighting, pumps and other devices in the building in conjunction with the HVAC system.

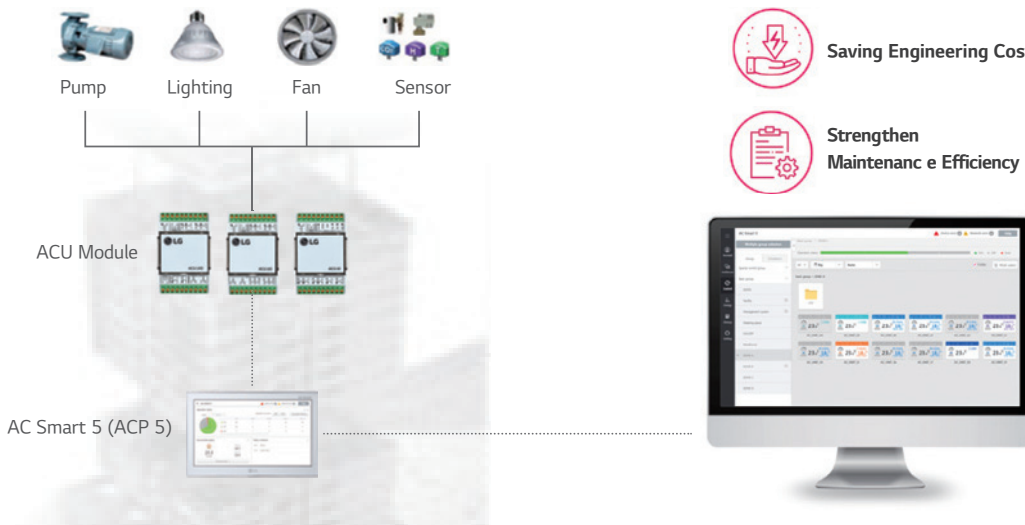

Interlocking Solution Using Dry Contact

3rd party thermostats can be used to control LG air conditioners in a room by using a multi point dry contact. The dry contact enables basic control of air conditioners as well as making it possible to report the status and any errors impacting the indoor unit. The Standard III remote control has a DO port. With this DO port, it is possible to interlock the indoor unit with 3rd party devices such as lighting, a fan, or a radiator, based on parameters like operation mode or current temperature. The indoor unit can be interlocked with various types of input such as card key-tag, door sensor, human detection sensor etc. so that the air conditioner is automatically operated. In addition, the dry contact option settings enable operation of air conditioner to maintain proper temperature when the occupant is absent. This solution makes sure that the room does not overheat or become too cold when unoccupied so that energy cost can be saved.



MULTI V[™] i

8 - 12 HP
380V, 3Ø



14 - 20 HP
380V, 3Ø



22 - 26 HP
380V, 3Ø



28 - 48 HP
380V, 3Ø



50 - 68 HP
380V, 3Ø



70 - 96 HP
380V, 3Ø

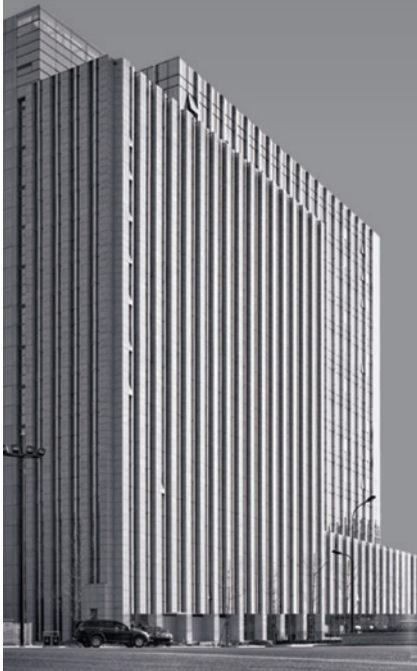

MULTI V[™] M



5 HP
220V, 1Ø
380V, 3Ø



MULTI VTM S

4 HP
220V, 1Ø



5 - 6 HP
220V, 1Ø

4 - 8 HP
380V, 3Ø



10 - 12 HP
380V, 3Ø



6 HP
220V, 1Ø

Heat Recovery



3 - 6 HP
220V, 1Ø
380V, 3Ø



MULTI VTM WATER 5

8 - 20 HP
380V, 3Ø

















































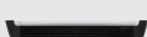

22 - 40 HP
380V, 3Ø







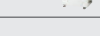

















42 - 60 HP
380V, 3Ø





























Features	Appearance	3	4	5	6	8	10	12	14	
<p>MULTI V™ i</p> <ul style="list-style-type: none"> • Large capacity ODU (Up to 26 HP) • Powerful cooling / heating performance • Flexible ODU combinaion • AI efficiency / comfort / smart up • Scability to various application • Continuous Heating • Black Fin heat exchanger • Flexible installation (Heat recovery unit & large capacity) • Large space, Individual control building <div style="display: flex; justify-content: space-around; align-items: center;"> <div style="text-align: center;">  Shopping mall </div> <div style="text-align: center;">  Education </div> <div style="text-align: center;">  Airport </div> </div>						●	●	●		
										●
										
										
										
										
<p>MULTI V™ s</p> <ul style="list-style-type: none"> • Space saving • Flexible design Slim, light, broad range (3 -12 HP) Large number of connectable indoor units (Up to 20 Units) • Small, Medium building <div style="display: flex; justify-content: space-around; align-items: center;"> <div style="text-align: center;">  Apartment </div> <div style="text-align: center;">  House & villa </div> </div>			○							
			●	○	○	●	●	●		
	 HEAT RECOVERY					○				
	 R32		○	○	○	○				
<p>MULTI V™ M</p> <ul style="list-style-type: none"> • High flexibility of installation • Various indoor unit combinations & long distance between modules • Retail shop <div style="display: flex; justify-content: space-around; align-items: center;"> <div style="text-align: center;">  Office </div> <div style="text-align: center;">  Cafe </div> <div style="text-align: center;">  Restaurant </div> </div>					●					
	<p>MULTI V™ WATER5</p> <ul style="list-style-type: none"> • High efficiency systems • Indoor installation • Low noise operation (No fan) • Simultaneous cooling & heating • Individual control building, Large building <div style="display: flex; justify-content: space-around; align-items: center;"> <div style="text-align: center;">  Hospital </div> <div style="text-align: center;">  Resort </div> </div>						●	●	●	●
										
										

		kW																
		1.5	2.2	2.8	3.6	4.5	5.6	6.2	7.1	8.2	9.0	10.6	12.3	14.1	15.8	22.4	28.0	
		5k	7k	9k	12k	15k	18k	21k	24k	28k	30k	36k	42k	48k	54k	76k	96k	
4 th generation Wall Mounted	Artcool Gallery 		●	●	●													
	Artcool Mirror 	●	●	●	●	●	●		●									
	Standard 	●	●	●	●	●	●		●		●	●						
4 th generation Ceiling Mounted Cassette	4 Way Cassette (570 x 570) 	●	●	●	●	●	●	●										
	4 Way Cassette (840 x 840) 								●	●	●	●	●	●				
	4 Way Cassette High Sensible (840 x 840) 	●	●	●	●	●	●		●	●		●	●	●				
	Round Ceiling Cassette 								●			●		●				
	2 Way Cassette 			●	●		●		●									
	1 Way Cassette 		●	●	●		●		●									
4 th generation Ceiling Concealed Duct	Mid / High Statics 		●	●	●	●	●		●	●		●	●	●	●	●	●	
	Low Static (Slim) 	●	●	●	●	●	●	●	●									
	High Sensible 		●	●	●	●	●		●	●		●	●	●				
4 th generation Fresh Air Intake 																●	●	
4 th generation Ceiling & Floor Convertible 			●	●														
4 th generation Ceiling Suspended 							●		●			●		●				
4 th generation Console 		●	●	●	●													
4 th generation Floor Standing	Floor Standing with Case 		●	●	●	●	●		●									
	Floor Standing without Case 		●	●	●	●	●		●									
Floor Standing (PAC) 														●			●	
4 th generation HYDRO KIT	Wall-Mounted 						●		●		●							
	Low Temperature 												●				●	
	High Temperature 												●			●		
4 th generation Energy Recovery Ventilator with DX Coil	with Humidifier 					●			●		●							
	without Humidifier 					●			●		●							

※ If 4th generation indoor units are combined to 2nd generation indoor units, several functions are not available.
More detailed information, refer to the "MULTI V Indoor units Compatibility Table"

Individual Control			Centralized Control		
Wired Remote Controller		Wireless Remote Controller	Display	Platform	Gateway
Standard	Simple				
Standard III (White)			AC Ez	ACP 5	Modbus RTU gateway
					
PREMTB100	PQRCVCLQW	PWLSSB21H (Heat Pump) PWLSSB21C (Cooling Only)	PQCSZ250S0 (Indoor Unit ~ 32)	PACP5A000 (Indoor Unit ~ 256) BACnet IP / Modbus TCP * -64, Lonworks with U60FT	PMBUSB00A (Indoor Unit - 64)
Standard III (Black)		Wi-Fi Modem	AC Ez Touch	AC Manager 5	KNX gateway
					
PREMTBB10	PQRCVCLQ	For Indoor Unit PWFMD200	PACEZA000 (Indoor Unit ~ 64)	PACM5A000 (Indoor Unit ~ 8,192)	INKNXLGE0160036 (Indoor Unit ~16) INKNXLGE0640036 (Indoor Unit ~64)
Standard II (White)			AC Smart 5		
					
PREMTB001	PQRCHCAQW (Simple for Hotel)		PACS5A000 (Indoor Unit ~ 128) BACnet IP / Modbus TCP		INKNXLGE001R000 (For Indoor Unit)
Standard II (Black)					PI485
					
PREMTBB01	PQRCHCAOQ (Simple for Hotel)				For Indoor Unit (ERV) PHNFP14A0
Premium					
					
PREMTA000 PREMTA000A PREMTA000B					For AWH-HP PP485A00T
					
					For Outdoor Unit (SINGLE / MULTI / THERMA V) PMNFP14A1

Centralized Control	Integration Device			
	Indoor Unit		Outdoor Unit	AHU Kit
	Dry Contact	Control Accessory		
Facility Integrator PDI (Power Distribution Indicator)  Premium (8 ports) PQNUD1S40 Standard (2 ports) PPWRDB000	 Simple Dry Contact PDRYCB000	Group Control Wire  PZCWRCG3	IO Module (Input / Output Module)  For MULTI V IV, 5, i PVDSMN000	Communication Kit  Return / Room Air Control PAHCMR000
ACS IO Module (Input / Output Module)  PEXPMB000	 Dry Contact for Thermostat PDRYCB320	Remote Temperature Sensor  PQRSTA0	Variable Water Flow Control Kit  For MULTI V WATER 5 PWFCN000	 Discharge / Supply Air Control PAHCMS000
ACU IO Module UIO  PEXPMB300	 2 Points Dry Contact (For Setback) PDRYCB400	Zone Controller  4 Zones by thermostat ABZCA	Low Ambient Kit  For MULTI V IV, 5, i PRVC2	Controller Module  Main Module PAHCMM000
UO  PEXPMB200	 For Modbus PDRYCB500 / PDRYCB510 (w/o case)	Multi-tenant Power Module  PINPMB001	Cool / Heat Selector  PRDSBM	 Communication Module PAHCMC000
UI  PEXPMB100				Control Kit  PAHCNM000 (Max. 3 Outdoor Units)
				Water Communication Module  PAHCMW000
EEV Kit (Electronic Expansion Valve)				
		 PRLK048A0 (~ 28 kW) PRLK096A0 (~ 56 kW)	 PRLK396A0 (~ 112 kW)	 PRLK594A0 (~ 168kW)

026 ~ 113

MULTI V *i*

MULTI V S

MULTI V M

MULTI V WATER 5
(Heat pump / Heat recovery)

OUTDOOR UNITS



MULTI V™ i

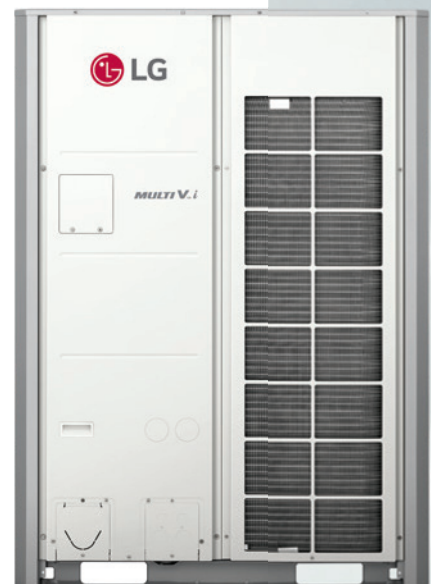
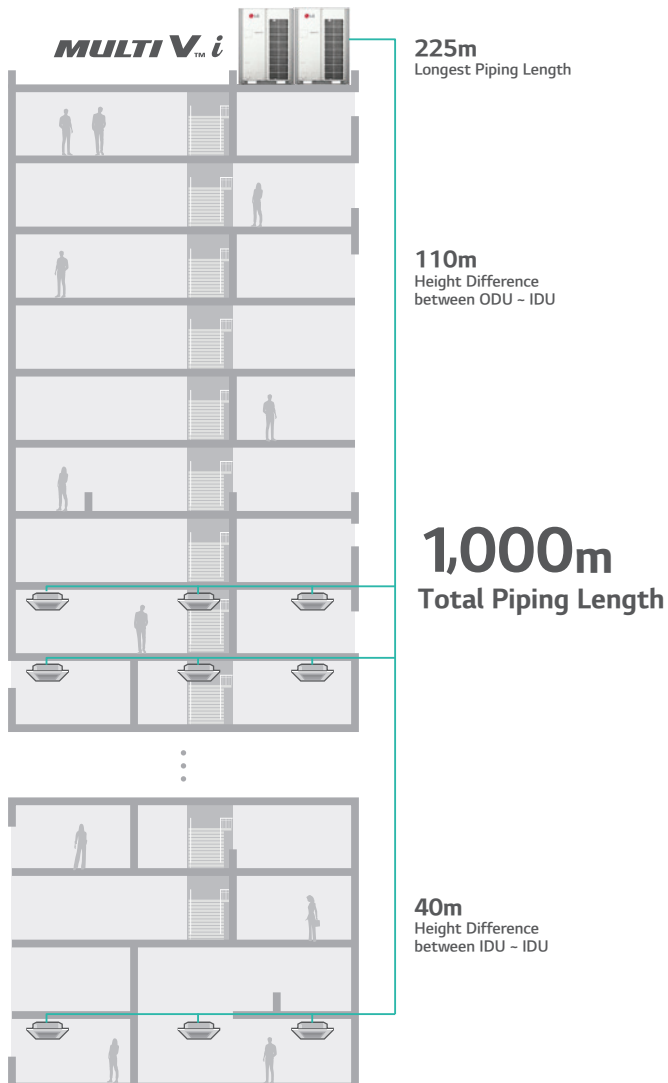

Highlight



Energy savings



Reliability



Low noise



Advanced performance



Dual Sensing



Partial Defrost

- Air-cooled VRF Heat Pump & Heat Recovery
- 22.4kW ~ 268.8kW (Cooling capacity based)
- 3Ø, 380 ~ 415V, 50Hz
- Top discharge outdoor unit
- Ability to function as Heat Pump or Heat Recovery

How does it work?

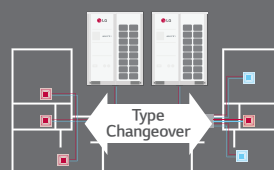

Interchangeable between
heat pump and heat recovery



01 INNOVATIVE

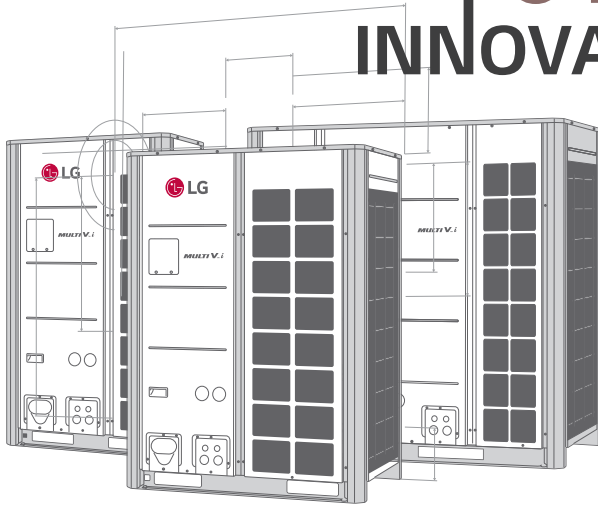

Innovative Energy efficiency / Performance realization

- Maximum 26HP for a Single Outdoor Unit
- Compact Design with Larger Capacity
- Powerful Performance
- Powerful Cooling Performance
- Powerful Heating Performance
- Newly Designed Compact Fan
- Flexible Outdoor Units Combination
- Corrosion Resistance

02 INTELLIGENT

Various environment recognition & optimized operation itself with AI Engine

AI EFFICIENCY UP

- AI Smart Care
- AI Energy Management

AI COMFORT UP

- Adaptive Noise Control
- Noise Target Control
- Weather Information Interlocking Control

AI SMART UP

- AI Smart Diagnosis
- Large Capacity Black Box
- Auto Tuning System
- Remote Upgrade System



03 INTERACTIVE

Upgrading & evolutionary system according to customer

- LG's Control Solution
- New Innovative Controller
- Smart GUI



Interlocking System

- **A/C**
(Air Conditioner)
- **LG AHU**
- **Valve / Pump**
AO (Analog Output)
- **Occupancy Sensor / Alarm / Key-Tag**
DI (Digital Input)
- **Fan / Lighting / Switch**
DO (Digital Output)
- **Temperature / Humidity / CO₂ Sensor**
AI (Analog Input)



Maximum 26HP for a Single Outdoor Unit

LG MULTI V.i saves space, time, and installation costs by offering a larger capacity single outdoor unit.



Compact Design with Larger Capacity

More area for the gardening on the roof and less architecture structure by less installation area and lighter outdoor units.

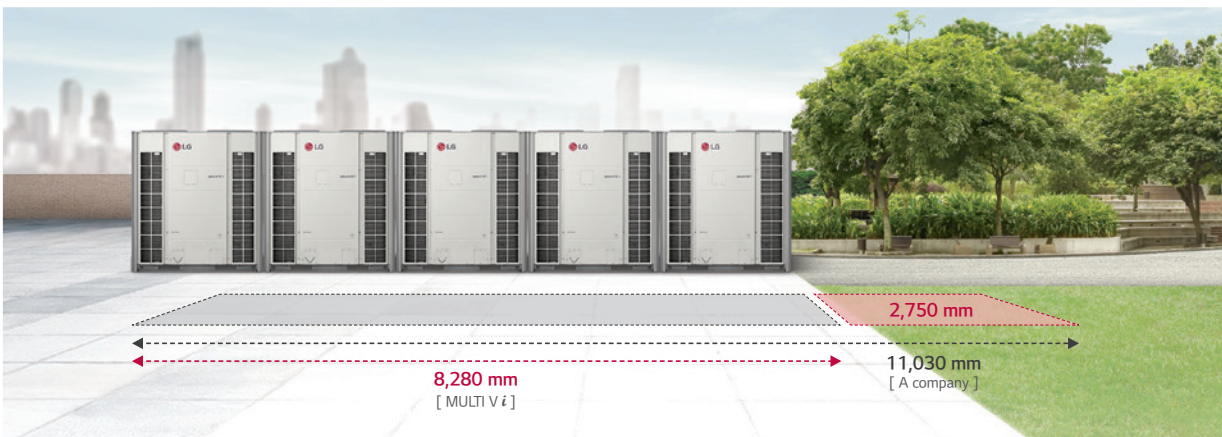

Install 260HP

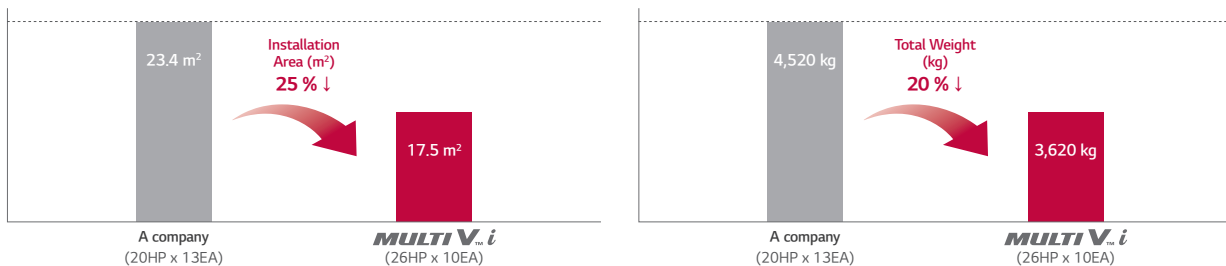

※ Previous model: ARUM261LTE5, New model: ARUM260LTE6
 ※ This scene is designed only for easier understanding, because 26HP unit cannot be applicable.

Powerful Performance

MULTI V 5 has already proved itself highly competitive in the European market in terms of efficiency levels, but MULTI V *i* exceeded its predecessor.

[Better than the Best]



※ For certain models in the line-up.

Powerful Cooling Performance

Reliable cooling operation up to 52°C, with full performance at 43°C. End users are able to enjoy comfortable indoor environment even in case of extreme weather conditions outside.

	MULTI V.i	MULTI V.5
Cooling Operation Range	-15 ~ 52°C	-15 ~ 48°C
Performance at 43°C	Full	92 %

※ Final specifications may change slightly.

Powerful Heating Performance

More reliable heating operation is provided at down to -30°C and full performance at -10°C. Stable and heating performance is guaranteed even in case of an unexpected outdoor temperature drop.



Full Performance at -10°C



Heating Performance

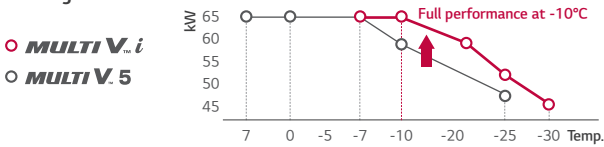

※ Final specifications may change slightly.

Stable & Powerful Heating

	MULTI V.i	MULTI V.5
Heating Operation Range	-30 ~ 16°C	-25 ~ 16°C
Performance at -10°C	Full	92 %

Improved design

Improved design for defrost by independent HEX system and accumulated freezing prevention design. With a differentiated structure and design, it provides longer heating time and reduced defrost time.

Continuous Heating

The heating operation duration was extended by independent HEX system for defrosting.

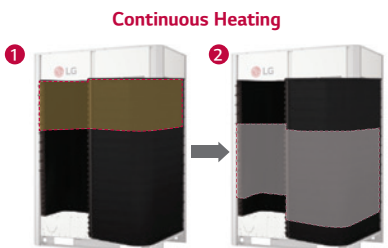
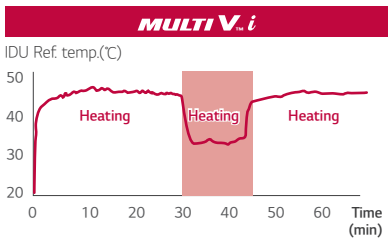
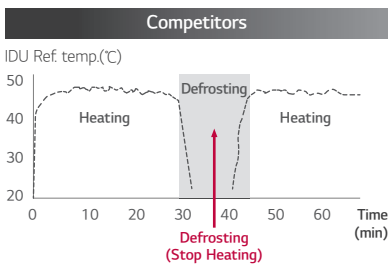

※ The defrost process is simplified for easier understanding.

NEW Accumulated Freezing Prevention Design

Preventing the freezing of the lower part of the heat exchanger



Defrost Time Reduction **65% ↓**
 Indoor outlet air temperature deviation during heating minimum load operation **70% ↓**

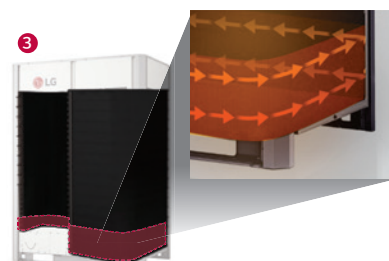

※ HEX: Heat Exchanger

Newly Designed Compact Fan

The design of a new biomimetic fan was inspired from nature. It brings more air volume and less noise with the same air flow rate compared to the conventional system.



※ Final specifications may change slightly.

Fan Noise Level
2.6dB Reduction

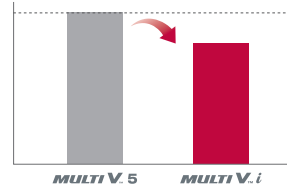

Fan Power Consumption
12% Reduction

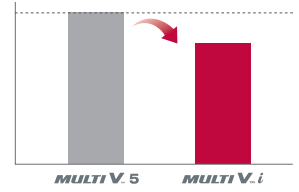

NEW Designed Biomimetic Fan

The new biomimetic fan has 6 blades that can reduce noise level and power consumption.

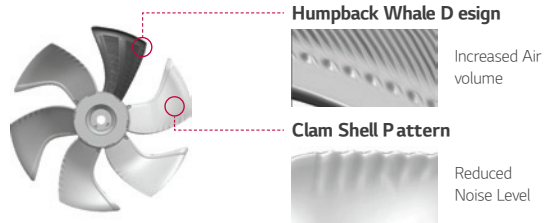

Compact Aero-Design

With an optimal air flow, the noise level and power consumption is reduced.

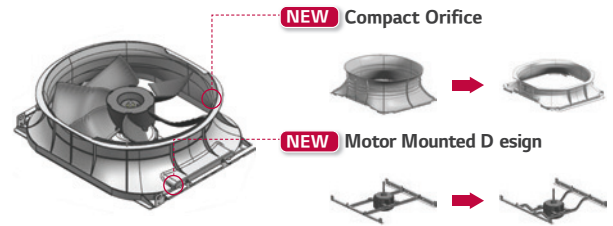

Flexible Outdoor Units Combination

Flexible combination can contribute to realize faster delivery and installation. It provides more options for designing according to customers' preferences.

Applicable Free Combination



2 Units : 28-36 HP
3 Units : 50-56 HP
4 Units : 70-76 HP

Standard Combination



18HP 12HP

Flexible Combination



20HP 10HP

Flexible Combination



16HP 14HP

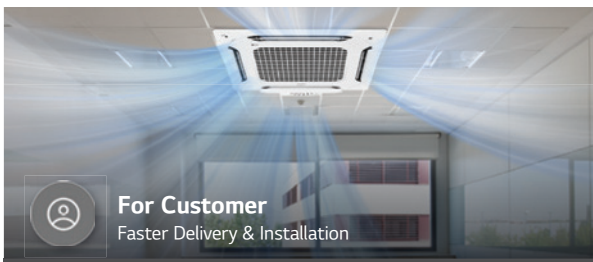

For Customer
Faster Delivery & Installation



For Consultant
Flexible Design for higher efficiency

※ The UXC chassis models are not applicable to free combination.
※ The 26 HP model of UXC chassis cannot be combined with other models.
※ More information can be checked in the LATS tool.

Corrosion Resistance

“Corrosion Resistance Black Fin” heat exchanger is designed for improved corrosion resistance. Body panels are also designed for improved corrosion resistance. 2,000 hours for body panels and 10,000 hours for heat exchanger make the product more reliable for customers.

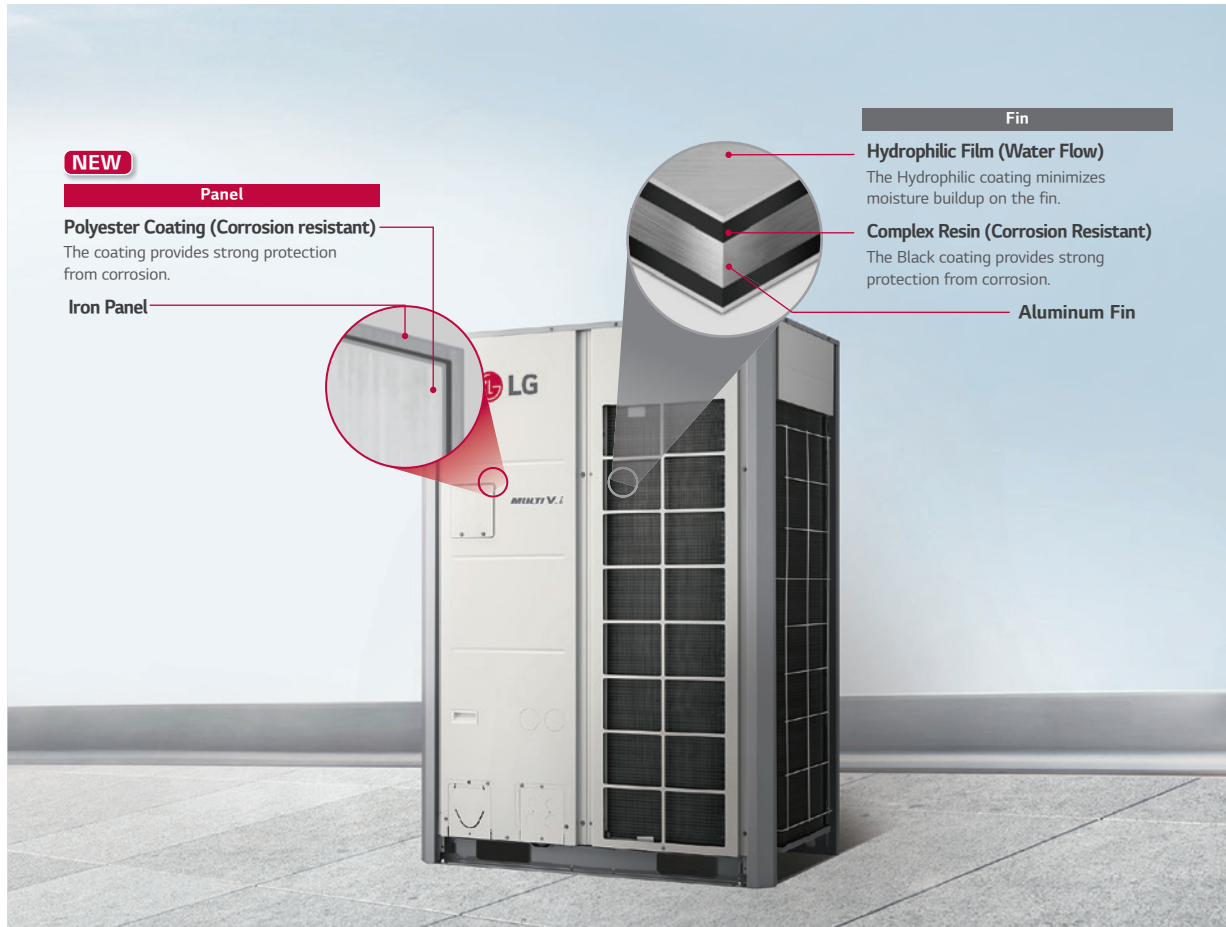

Salt Spray Test (SST) × Process repeated

5% Area of defects compared to initial state.

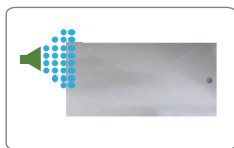

Fog¹⁾
(35°C, 24hr)



※ Verification of corrosion resistance performance
- Test Method B of ISO21207
- ASTM B117 / (2,000 hours)(Last updated : Jul. 2022)

Salt Spray Test (SST) × Process repeated

5% Area of defects compared to initial state.

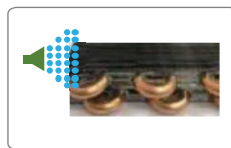

Fog¹⁾
(35°C, 24hr)



※ Verification of corrosion resistance performance
- Test Method B of ISO21207
- ASTM B117 / ISO 9227 (5,000 hours →10,000 hrs.)(Last updated : Dec. 2020)

286 %



Test process is conducted according to ASTM B117
1) Salty water concentration : NaCl aqueous solution (5%)

100 %

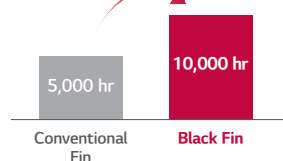

Test process is conducted according to ASTM B117.
1) Salty water concentration : NaCl aqueous solution (5%)

※ The product is not fully anticorrosive. To install near the sea, additional measures can be required.

AI Smart Care

MULTI V *i* is capable of autonomous adaptation to various situations. When no one is in the space, power saving mode automatically turns on. MULTI V *i* is equipped with deep learning algorithms enabling it to self-learn.

Data Collecting and Saving from IDU & ODU

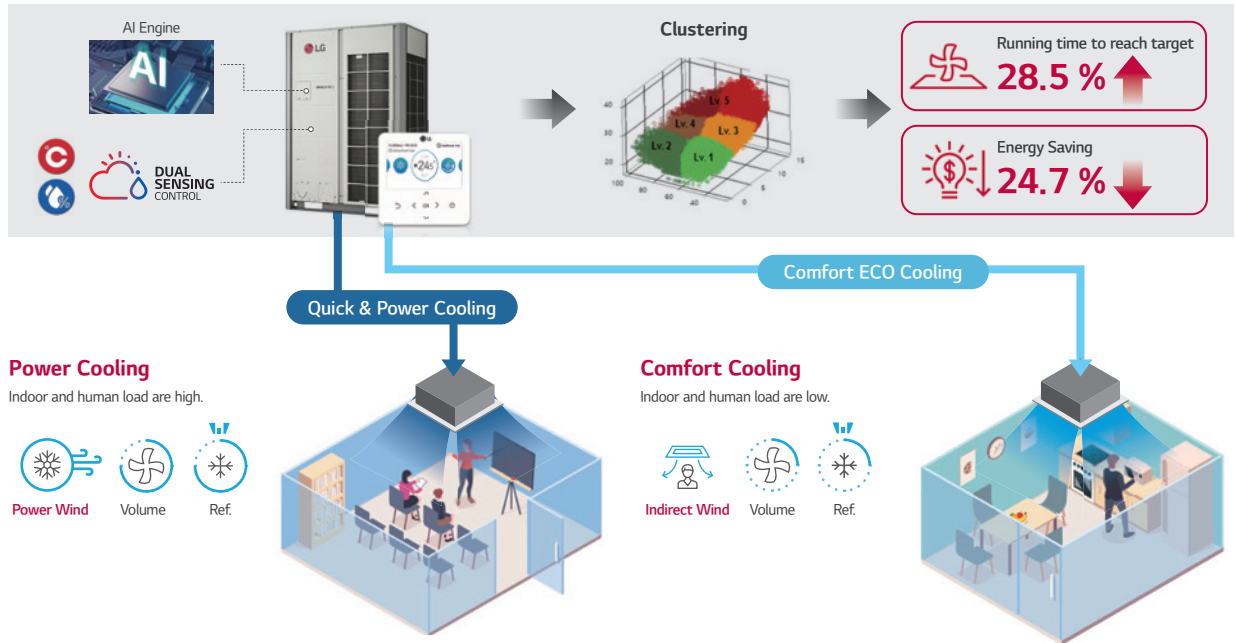

※ This is the result from internal test that is followed KS Test Standard, the result may be differed by applied model, local temperature, and environment.
 - Model : MULTI V *i* 57 kW - Test Standard : KS B ISO15042

AI Energy Management

MULTI V *i* is able to preset monthly energy usage and consume power according to the target that has been previously set. By Comparing and analyzing previous power consumption of the current month and planned daily energy usage, overuse of the HVAC system operational costs can be prevented by AI Energy management.

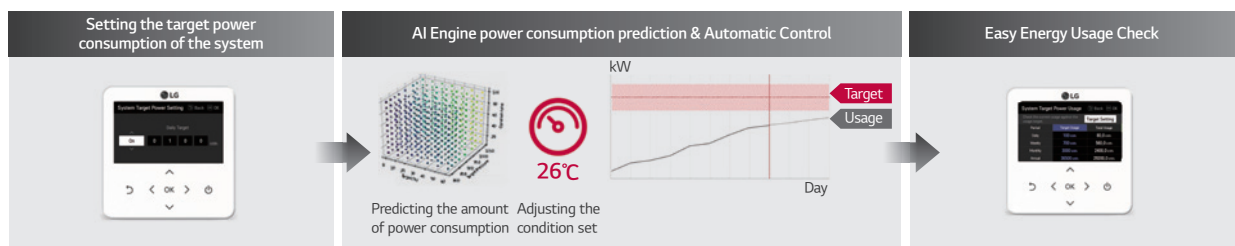

※ If more accurate status for energy consumption is needed, ACP and PDI have to be installed.

Adaptive Noise Control

The outdoor unit's noise level is automatically adjusted to the ambient conditions guaranteeing the customers' peace of mind, as they no longer have to worry about causing noise damage to neighbors.



※ This function will be available in 1H '24

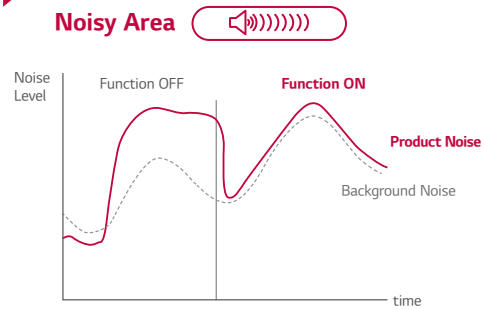
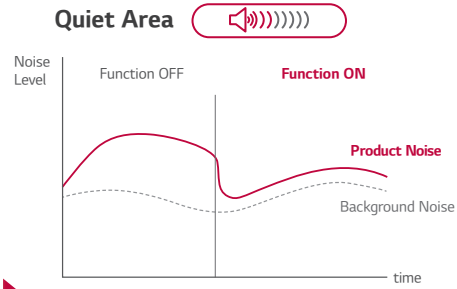

Noise Target Control

The outdoor unit's noise can be restricted by the set sound level in advance, allowing customers to enjoy comfortable conditions while avoiding disturbing their neighbors and complying with the local noise regulations.



Available Setting
50 / 55 / 60 / 65 / 70 dB

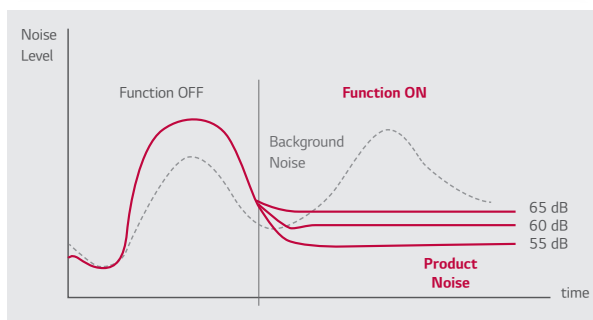
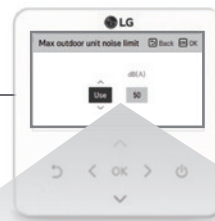

Weather Information Interlocking Control

LG MULTI V *i* provides more comfort and convenience by checking ambient weather conditions.

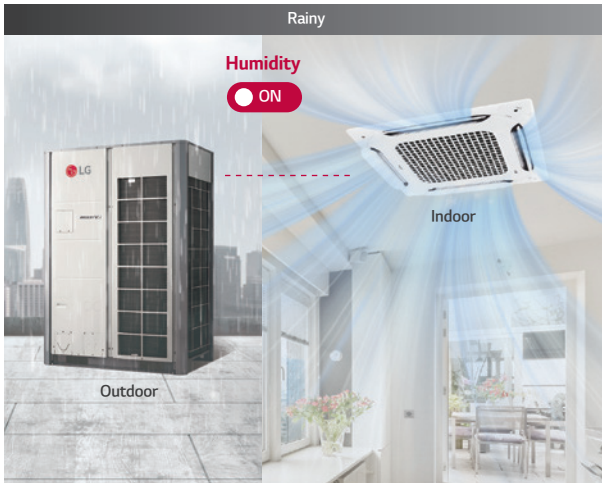

MULTI V *i*
 Sensing Temp. & Humidity

Hot
 Comfort
 Cold

Automatic Comfort / Energy Saving mode

Manage Ref. Manage Ref. temp.

This block contains a vertical color-coded bar with 'Hot' (orange), 'Comfort' (green), and 'Cold' (blue) sections. To the left is a red circular icon with a flame and the text 'Automatic Comfort / Energy Saving mode'. To the right are two circular icons: one with snowflakes and another with a thermometer, both labeled 'Manage Ref.' and 'Manage Ref. temp.' respectively.



※ Connecting with the AccuWeather is needed the ThinQ server.
 ※ The operation is based on AccuWeather information.

AI Smart Diagnosis

AI Smart Diagnosis saves service time and provides for reliable LG MULTI V.i operation by automatically analyzing and visualizing the product's performance status.

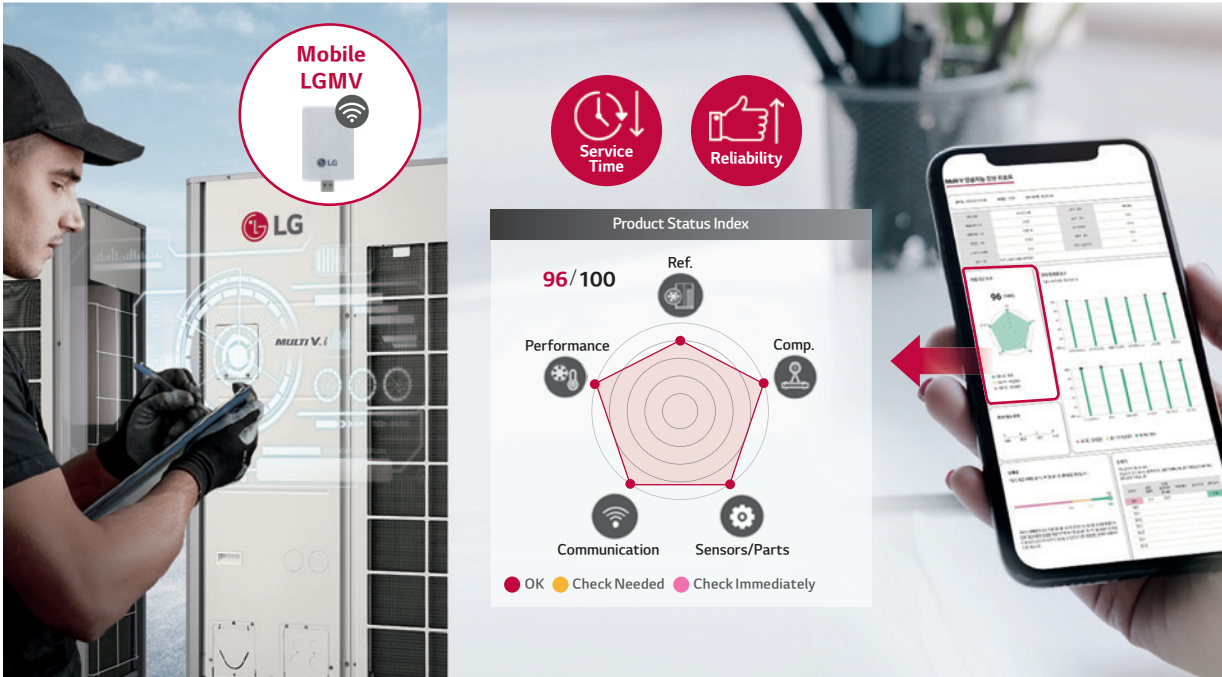

※ UI may be changed without notification.

Large Capacity Black Box

Operation data can be saved for up to 6 months before the system failure, contributing to quick service of the product.



※ UI may be changed without notification.

Auto Tuning System

LG MULTI V *i* provides a new experience to customers with faster and easier installation and service with AI engine which is automatically upgradable when the compressor and motor are replaced.

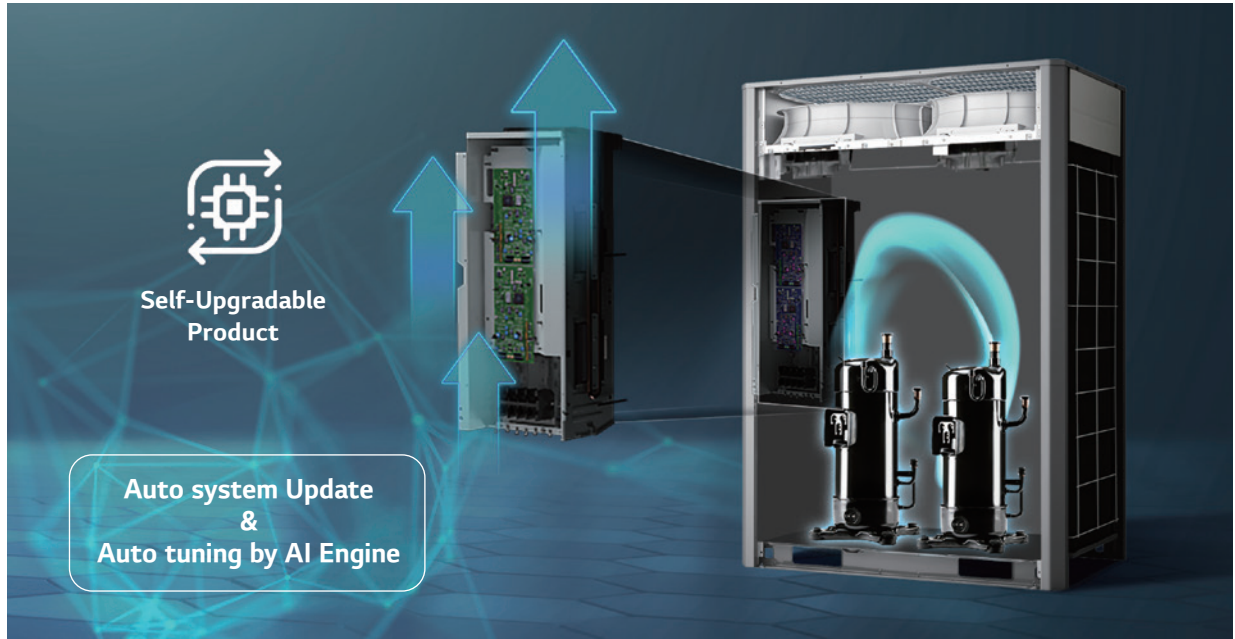

※ This function is to be applied to compressor and fan motor.

Remote Upgrade System

Like a smart phone, LG MULTI V *i* upgrades itself remotely! You can opt for the latest version of software immediately without on-site service

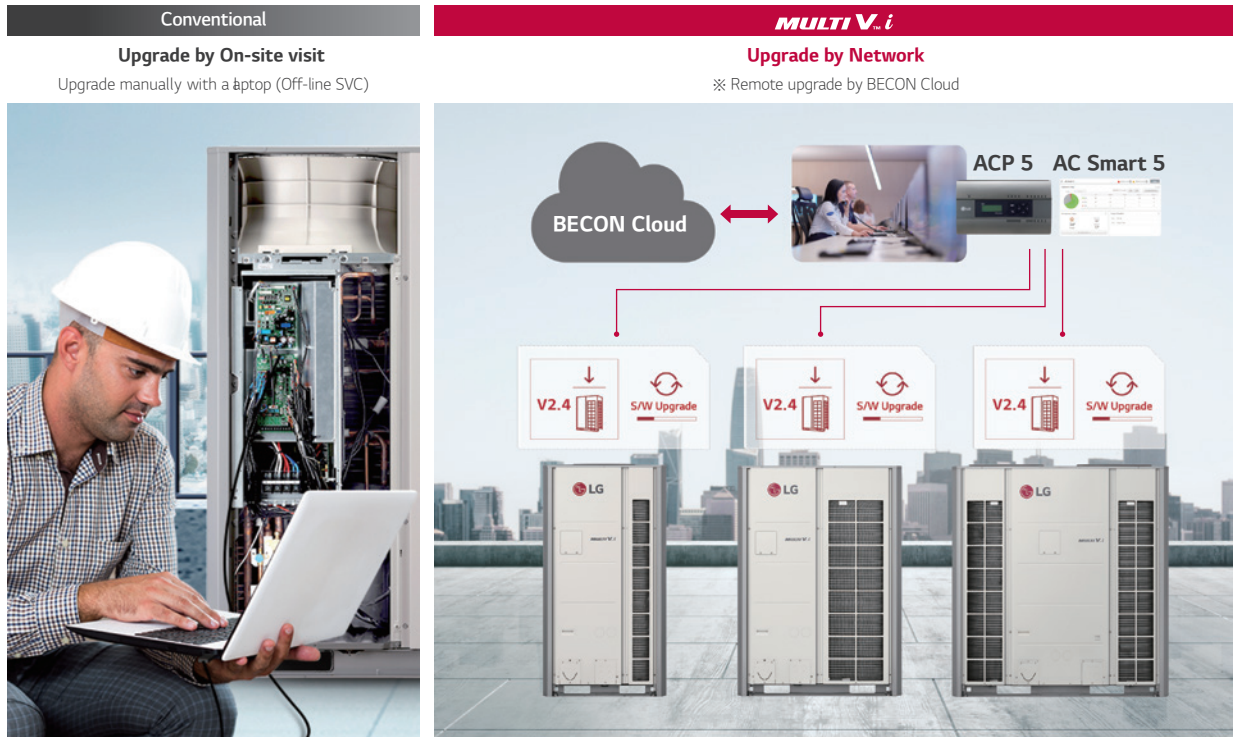

※ LG BECON Cloud is needed.

LG's Control Solution

LG MULTI V *i* offers diverse range of effective control solutions that satisfy specific needs of each building and its user scene.

Hotel

Hotel Room Solution



Office

Central Control Solution

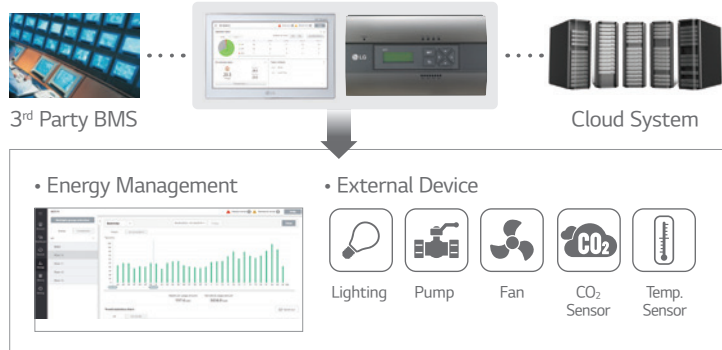

Apartment

Power Distribution Solution



Residential

Smart Individual Control Solution



Small Building

Small Central Control Solution



Smart GUI

Smart GUI allows remote management via various devices such as PC, tablet and smart phone.





AM 11:00

Monitoring room
PC



PM 02:00

Checking each room
Tablet



PM 05:00

Working outside
Mobile



Schedule function



Energy Management



Operation Trending Report



Automatic E-mail Sending

New Innovative Controller

LG Deluxe remote controller provides better customer experience. (easy to use, E-saving and easy maintenance)



Features

- Installation wizard
- Built-in Wi-Fi with ThinQ Capability
- Humidity / Proximity sensor
- Seven (7) Day Scheduling with Mode - Home / Away / Sleep / Awake
- Function Code search Tool

* This remote controller will be available 1H, '23
 ※ UI may be changed without notification.

Full touch & Slim design

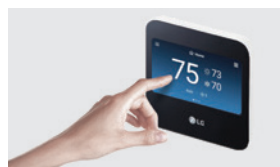

LG Deluxe has full touch LCD screen & slim design suitable for the residential application. In addition, user-oriented UX design enhances user convenience.

Air quality Monitoring



LG Deluxe can display air quality status when air purifying device is installed. And also shows air quality monitoring history by day, week, month and year.

Pre-set Schedule

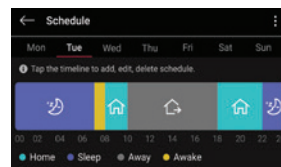

Seven Day scheduling with Home/Away/Sleep/Awake mode makes configuration much easier. And seasonal program setting offers more flexibility.

Energy Navigation

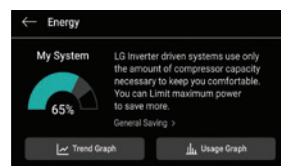

The Energy Navigation provides system operation trend per day. Running time and power consumption is also provided compared to last year by week, month and year.

Remote Control



The built-in Wi-Fi module makes the connection to ThinQ cloud simple and easy. Seven day schedule is synchronized between ThinQ cloud and wired remote controller.

Easy Installation

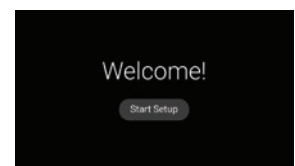

The installation wizard helps the customer set up the basic configurations (Date & Time, Language, Temperature unit etc.) easily at the stage of installation.

AI Function Application

Category	Sub Category	Tool	Application	AI Function					
				AI Smart Care	AI Indoor Space care	Convenient Energy Check	AI Energy Target Control	AI Smart Diagnosis	Weather Information Interlocking Control
Cassette	1Way	TU,TT	N/A	X	X	X	X		X
	2Way	TS	`23.2H	●	●	●	●		●
	Dual Vane 4Way	TM-A, TP-B	`23.1H	●	●	●	●		●
	Round	TY	`23.1H	●	●	●	●		●
	Mini 4Way	TQ, TR	`24.1H	●	●	●	●		●
Console		QA	`23.2H	●	●	●	●		●
Duct	Low Statics	L4, L5, L6	`23.1H	●	●	●	●	ODU Applicable	●
	High Statics	B8	`23.1H	●	●	●	●		●
	Mid Statics	M1, M2, M3	`23.2H	●	●	●	●		●
Floor Standing		CE, CF	`23.1H	●	●	●	●		●
Fresh Air Intake		B8	`24.1H	X	X	●	●		●
Convertible	Ceiling Suspended	VM1, VM2	`24.1H	●	●	●	●		●
	Ceiling & Floor	VE	`24.1H	●	●	●	●		●
Floor standing (PAC)		PT3, PF	`24.1H	●	X	●	●		●
Wall Mounted	Artcool, Standard	SJ, SK, SV	`23.1H	●	●	●	●		●
	Gallery	SF	N/A	X	X	X	X		X
Hydro Kit		K1, K2, K3	`24.1H	X	X	●	●		●

※ Some functions may not be available depending on the type of indoor unit.

Nomenclature

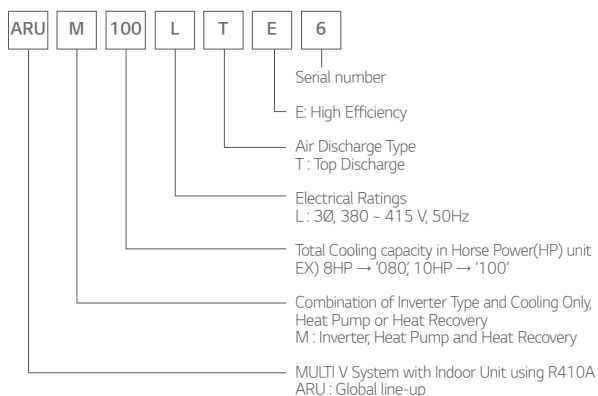

Position of Sound Pressure Level Measuring

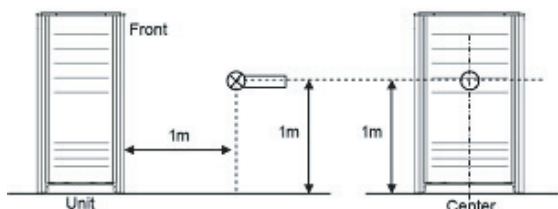

- Data is valid at diffuse field condition.
- Data is valid at nominal operating condition.
- Reference acoustic pressure 0dB = 20μPa.
- Sound pressure level is measured on the rated condition in the anechoic rooms by ISO 3745 standard. Refer to the model specifications for nominal conditions. (Power source and Ambient temperature, etc)
- Sound levels can be increased in accordance with installation and operating conditions.(Operating conditions include some functional condition like Static pressure mode, air guide use, Room target temperature setting, etc and these functions are different in accordance with each model)
- Sound level will vary depending on a range of factors such as the construction(acoustic absorption coefficient) of particular room in which the equipment is installed.

Outdoor Units Function

Category	Functions	Value
Reliability	Defrost / Deicing	○
	High Pressure Switch	○
	Phase Protection	○
	Restart Delay (3-minutes)	○
	Self Diagnosis	○
	Soft Start	○
Convenience	Compressor Balanced Operation	○
	Test Function	○
	Night Low Noise Operation	○
	Peak Control	○
	Mode Lock	○
	SLC (Smart Load Control)	○
Special Functions	Linear Bypass Cycle	○
	Noise Target Control	○
	Weather Information Interlocking Control	○
	Comfort Cooling	○
	ODU Dry Contact Function	○
	High Static Pressure Compensation	○
	Continuous Cooling	○
	Continuous Heating (Partial Defrost)	○
	Convenient Energy Check	○
	Automatic Tuning Upgrade	○
Remote Software Upgrade	○	
AI Smart Care	○	
AI Indoor Space Care	○	
AI Energy Target Control	○	
AI Smart Diagnosis	○	

○ : Applied, X : Not applied
 - Accessory : Ordered and purchased separately the accessory package referring to the model name provided and install at field.
 - Accessory line-ups varies by region, so check your local catalogue or local sales material

Cooling / Heating Operation

Cooling

Outdoor Temperature (°C DB)

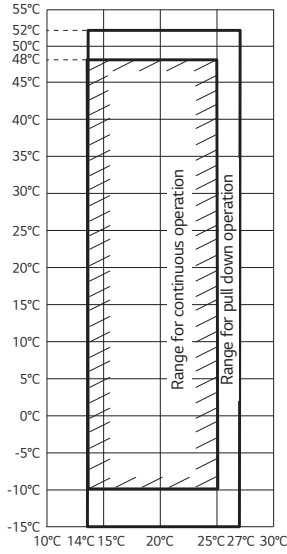

Indoor Temperature (°C WB)

Heating

Outdoor Temperature (°C WB)

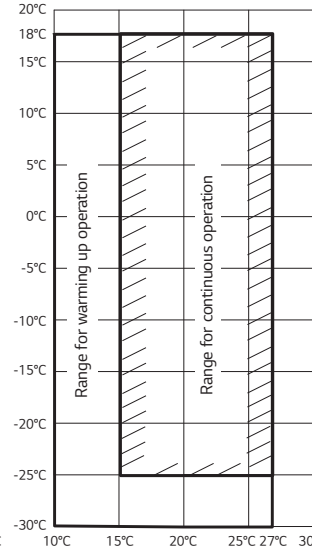

Indoor Temperature (°C DB)

Note

1. These figures assume the following operating conditions : Equivalent piping length is standard condition, and level difference is 0m.
2. Range of pull down operation: If the relative humidity is too high, cooling capacity can be decreased by the sensible heat reduction.
3. Warming up operation means that the outdoor(outside) unit operates to reach the range of continuous operating, however it may not operate continuously due to safety or protection logic.

Simultaneous Cooling / Heating Operation

Cooling

Outdoor Temperature (°C DB)

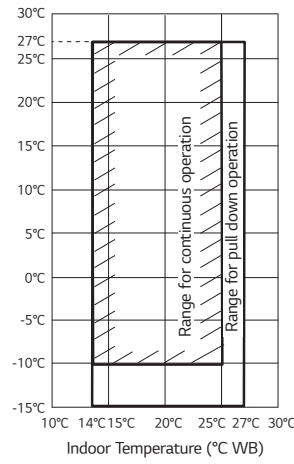

Indoor Temperature (°C WB)

Heating

Outdoor Temperature (°C WB)

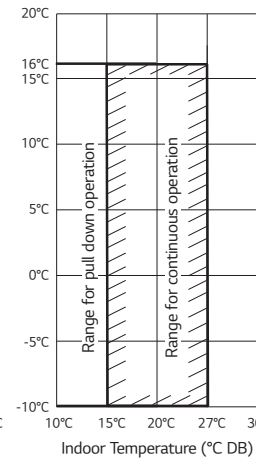

Indoor Temperature (°C DB)

Note

1. These figures assume the following operating conditions : Equivalent piping length is standard condition, and level difference is 0m.
2. Range of pull down operation: If the relative humidity is too high, cooling capacity can be decreased by the sensible heat reduction.
3. Warming up operation means that the outdoor(outside) unit operates to reach the range of continuous operating, however it may not operate continuously due to safety or protection logic.

[Unit : mm]

ARUM080LTE6 / ARUM100LTE6 /
ARUM120LTE6

No.	Part Name	Description
1	Leakage test hole (Side)	Ø22.2
2	Wire routing hole (Front)	2-Ø30
3	Wire routing hole (Bottom)	2-Ø22.2
4	Power cord routing hole (Front)	2-Ø45
5	Power cord routing hole (Bottom)	2-Ø50
6	Pipe routing hole (Front)	-
7	Pipe routing hole (Bottom)	-

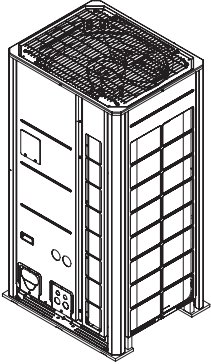

3D View

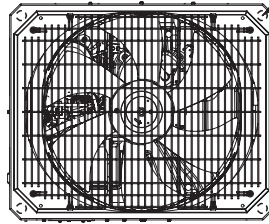

Airguide fastening total 12 places
(Refer to the hole on the Airguide for the fastening position.)

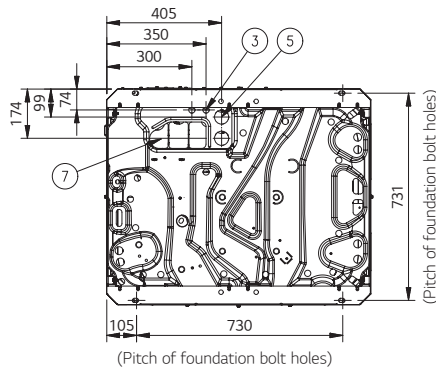
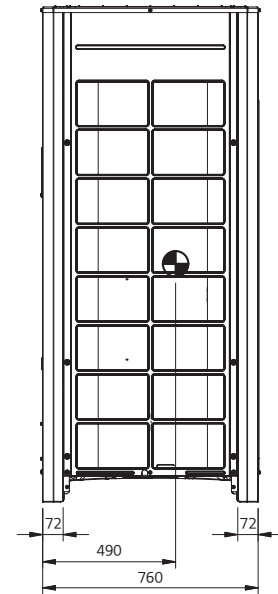
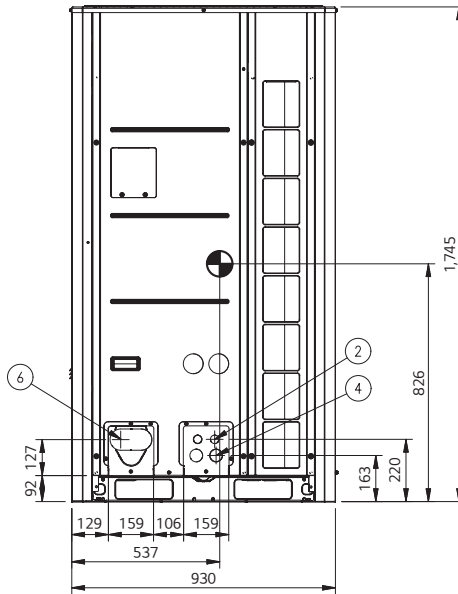
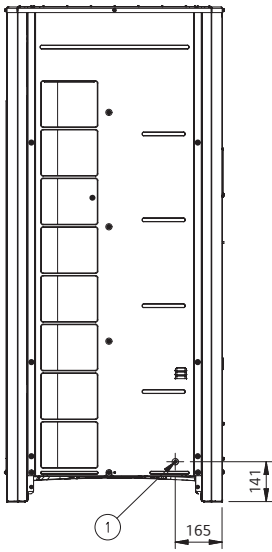

ARUM140LTE6 / ARUM160LTE6 /
ARUM180LTE6 / ARUM200LTE6 /

[Unit : mm]

No.	Part Name	Description
1	Leakage test hole (Side)	Ø22.2
2	Wire routing hole (Front)	2-Ø30
3	Wire routing hole (Bottom)	2-Ø22.2
4	Power cord routing hole (Front)	2-Ø45
5	Power cord routing hole (Bottom)	2-Ø50
6	Pipe routing hole (Front)	-
7	Pipe routing hole (Bottom)	-

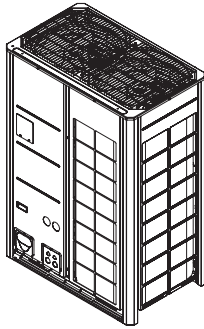

3D View

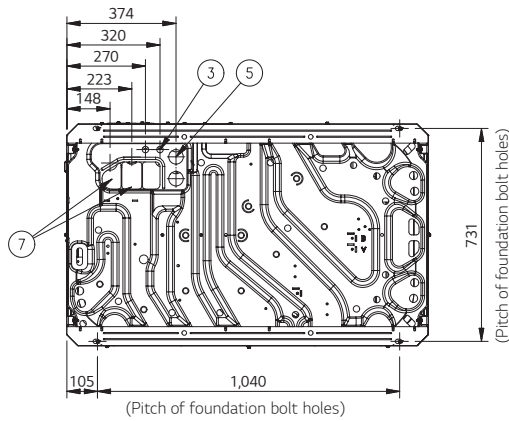
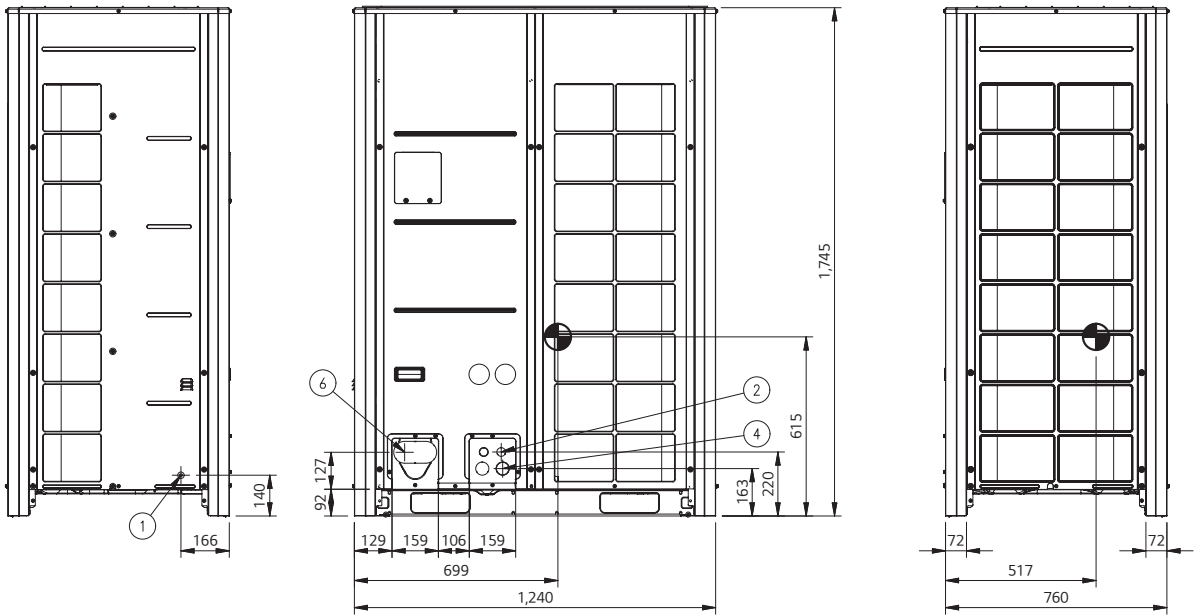
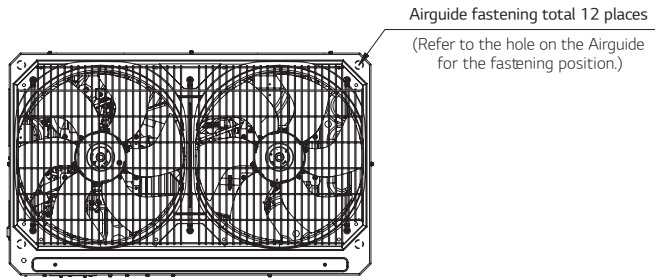

ARUM220LTE6 / ARUM240LTE6 /
ARUM260LTE6

No.	Part Name	Description
1	Pipe routing hole (Bottom)	-
2	Pipe routing hole (Front)	-
3	Power cord routing hole (Front)	2-Ø30
4	Wire routing hole (Front)	2-Ø45

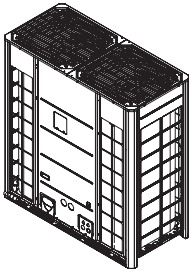

3D View

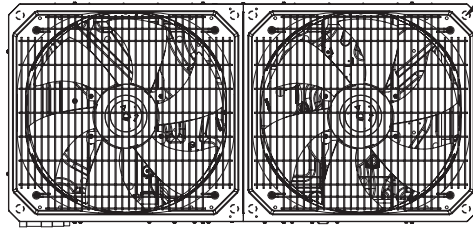

Airguide fastening total 12 places
(Refer to the hole on the Airguide for the fastening position.)

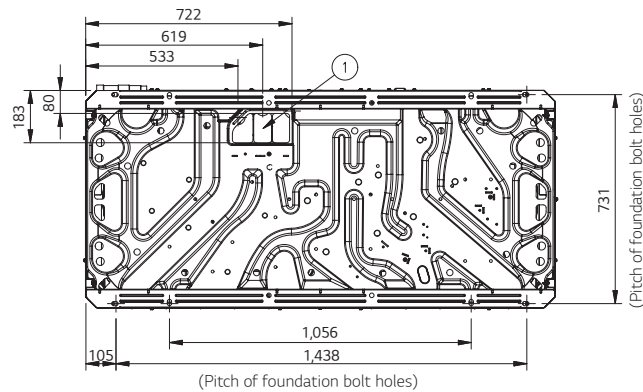
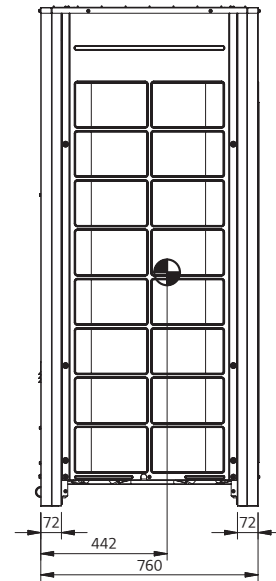
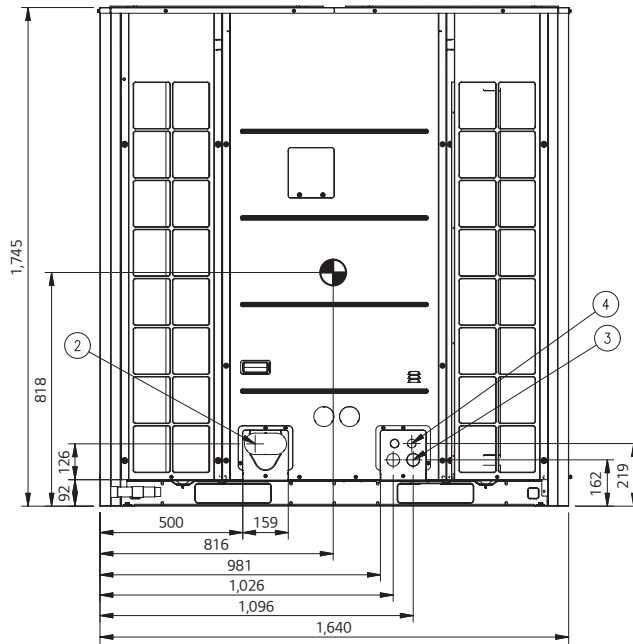
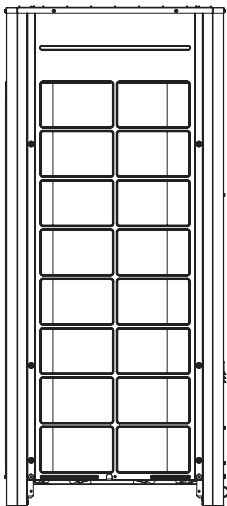

**ARUM080LTE6 / ARUM100LTE6
ARUM120LTE6 / ARUM140LTE6**



LG participates in the ECP programme for EUROVENT VRF program. Check ongoing validity of certification : www.eurovent-certification.com

HP			8	10	12	14
Classification	Chassis		UXA	UXA	UXA	UXB
	Combination Unit		ARUM080LTE6	ARUM100LTE6	ARUM120LTE6	ARUM140LTE6
Power Supply	V / Ø / Hz		380-415 / 3 / 50	380-415 / 3 / 50	380-415 / 3 / 50	380-415 / 3 / 50
Cooling Capacity	Rated	kW	22.4	28.0	33.6	39.2
	Heating Capacity					
Heating Capacity	Rated	kW	22.4	28.0	33.6	39.2
	Max	kW	25.2	31.5	37.8	44.1
Power Input (Cooling)	Rated	kW	6.10	8.33	11.65	11.88
Power Input (Heating)	Rated	kW	5.16	6.22	7.77	8.43
Efficiency	EER (Rated)	W/W	3.67	3.36	2.88	3.30
	COP (Rated)	W/W	4.34	4.50	4.32	4.65
	SEER	Wh/Wh	8.28	8.11	7.94	8.55
	SCOP	Wh/Wh	4.45	4.52	4.99	5.17
Outdoor Fan	Type		Propeller Fan	Propeller Fan	Propeller Fan	Propeller Fan
	Air Flow Rate (High)	m³/min x No.	220 x 1	220 x 1	220 x 1	320 x 1
	Discharge direction (Side / Top)		Top	Top	Top	Top
Outdoor Fan Motor	Drive		Direct	Direct	Direct	Direct
	Output	W x No.	1,200 x 1	1,200 x 1	1,200 x 1	900 x 2
Compressor	Type		Hermetically Sealed Scroll	Hermetically Sealed Scroll	Hermetically Sealed Scroll	Hermetically Sealed Scroll
	Piston Displacement	cm³/rev	62.1	62.1	62.1	62.1
	Number of Revolution	rev./min	3,600	3,600	3,600	3,600
	Motor Output	W x No.	5,300 x 1	5,300 x 1	5,300 x 1	5,300 x 1
	Oil Type		FW68L (PVE)	FW68L (PVE)	FW68L (PVE)	FW68L (PVE)
Heat Exchanger	Fin Type		Wide Louver Plus	Wide Louver Plus	Wide Louver Plus	Wide Louver Plus
Dimensions	Net (W x H x D)	mm	930 x 1,745 x 760	930 x 1,745 x 760	930 x 1,745 x 760	1,240 x 1,745 x 760
	Shipping (W x H x D)	mm	965 x 1,919 x 802	965 x 1,919 x 802	965 x 1,919 x 802	1,282 x 1,919 x 802
Weight	Net	kg	215	215	215	255
	Shipping	kg	225	225	225	265
Refrigerant	Type		R410A	R410A	R410A	R410A
	Precharged Amount	kg	8.5	9.5	9.5	13.0
	t-CO ₂ eq.		17.744	19.831	19.831	27.138
	Control Type		EEV	EEV	EEV	EEV
Connecting Pipe	Liquid	mm (inch)	Ø9.52 (3/8)	Ø9.52 (3/8)	Ø12.70 (1/2)	Ø12.70 (1/2)
	Gas	mm (inch)	Ø19.05 (3/4)	Ø22.20 (7/8)	Ø28.58 (1-1/8)	Ø28.58 (1-1/8)
	Low Pressure Gas (Heat Recovery)	mm (inch)	Ø19.05 (3/4)	Ø22.20 (7/8)	Ø28.58 (1-1/8)	Ø28.58 (1-1/8)
	High Pressure Gas (Heat Recovery)	mm (inch)	Ø15.88 (5/8)	Ø19.05 (3/4)	Ø19.05 (3/4)	Ø22.20 (7/8)
Sound Pressure Level (Outdoor Unit)	Cooling	dB (A)	57.0	57.5	59.0	60.0
	Heating	dB (A)	58.0	58.5	60.0	61.0
Sound Power Level (Outdoor Unit)	Cooling	dB (A)	78.0	79.0	80.0	81.0
	Heating	dB (A)	78.0	79.0	82.0	81.0
Connecting Cable	Communication Cable (VCTF-SB)	mm² x cores	0.75 - 1.5 x 2C	0.75 - 1.5 x 2C	0.75 - 1.5 x 2C	0.75 - 1.5 x 2C
Connectable Indoor Units Number	Max. (Conditional)	EA	13 (20)	16 (25)	20 (30)	23 (35)

1) Maximum numbers are prepared based on assumption that all 2.2kW indoor units are connected. The numbers in parentheses means maximum connectable indoor units in accordance with outdoor units combination (160% - 200%). The recommended ratio is 130%.

ARUM160LTE6 / ARUM180LTE6 ARUM200LTE6 / ARUM220LTE6



²⁾ LG participates in the ECP programme for EUROVENT VRF program. Check ongoing validity of certification : www.eurovent-certification.com

HP			16	18	20	22
Classification	Chassis		UXB	UXB	UXB	UXC
	Combination Unit		ARUM160LTE6	ARUM180LTE6	ARUM200LTE6	ARUM220LTE6
Power Supply	V / Ø / Hz		380-415 / 3 / 50	380-415 / 3 / 50	380-415 / 3 / 50	380-415 / 3 / 50
Cooling Capacity	Rated	kW	44.8	50.4	56.0	61.6
	Heating Capacity	Rated	kW	44.8	50.4	56.0
Heating Capacity	Max	kW	50.4	56.7	63.0	69.3
	Rated	kW	15.45	14.39	17.54	22.00
Power Input (Cooling)	Rated	kW	10.09	10.59	12.64	15.96
Power Input (Heating)	Rated	kW	10.09	10.59	12.64	15.96
	EER (Rated)	W/W	2.90	3.50	3.19	2.80
Efficiency	COP (Rated)	W/W	4.44	4.76	4.43	3.86
	SEER	Wh/Wh	7.97	8.65	8.42	7.20
	SCOP	Wh/Wh	5.46	4.81	5.13	4.62
	Type		Propeller Fan	Propeller Fan	Propeller Fan	Propeller Fan
Outdoor Fan	Air Flow Rate (High)	m³/min x No.	320 x 1	320 x 1	320 x 1	430 x 1
	Discharge direction (Side / Top)		Top	Top	Top	Top
	Drive		Direct	Direct	Direct	Direct
Outdoor Fan Motor	Output	W x No.	900 x 2	900 x 2	900 x 2	1,500 x 2
	Type		Hermetically Sealed Scroll	Hermetically Sealed Scroll	Hermetically Sealed Scroll	Hermetically Sealed Scroll
Compressor	Piston Displacement	cm³/rev	62.1	62.1 x 2	62.1 x 2	62.1 x 2
	Number of Revolution	rev./min	3,600	3,600 x 2	3,600 x 2	3,600 x 2
	Motor Output	W x No.	5,300 x 1	5,300 x 2	5,300 x 2	5,300 x 2
	Oil Type		FW68L (PVE)	FW68L (PVE)	FW68L (PVE)	FW68L (PVE)
Heat Exchanger	Fin Type		Wide Louver Plus	Wide Louver Plus	Wide Louver Plus	Wide Louver Plus
	Net (W x H x D)	mm	1,240 x 1,745 x 760	1,240 x 1,745 x 760	1,240 x 1,745 x 760	1,640 x 1,745 x 760
Dimensions	Shipping (W x H x D)		mm	1,282 x 1,919 x 802	1,282 x 1,919 x 802	1,675 x 1,919 x 787
	Net	kg	255	300	300	362
Weight	Shipping		kg	265	310	372
	Type		R410A	R410A	R410A	R410A
Refrigerant	Precharged Amount	kg	13.0	16.0	16.0	16.0
	t-CO ₂ eq.		27.138	33.400	33.400	33.400
	Control Type		EEV	EEV	EEV	EEV
Connecting Pipe	Liquid	mm (inch)	Ø12.70 (1/2)	Ø15.88 (5/8)	Ø15.88 (5/8)	Ø15.88 (5/8)
	Gas	mm (inch)	Ø28.58 (1-1/8)	Ø28.58 (1-1/8)	Ø28.58 (1-1/8)	Ø28.58 (1-1/8)
	Low Pressure Gas (Heat Recovery)	mm (inch)	Ø28.58 (1-1/8)	Ø28.58 (1-1/8)	Ø28.58 (1-1/8)	Ø28.58 (1-1/8)
	High Pressure Gas (Heat Recovery)	mm (inch)	Ø22.20 (7/8)	Ø22.20 (7/8)	Ø22.20 (7/8)	Ø28.58 (1-1/8)
Sound Pressure Level (Outdoor Unit)	Cooling	dB (A)	60.5	61.0	62.0	64.0
	Heating	dB (A)	61.5	62.0	63.5	66.0
Sound Power Level (Outdoor Unit)	Cooling	dB (A)	85.0	85.0	86.0	84.0
	Heating	dB (A)	85.0	86.0	89.0	88.0
Connecting Cable	Communication Cable (VCTF-SB)	mm² x cores	0.75 - 1.5 x 2C	0.75 - 1.5 x 2C	0.75 - 1.5 x 2C	0.75 - 1.5 x 2C
Connectable Indoor Units Number	Max. (Conditional)	EA	26 (40)	29 (45)	32 (50)	35 (56)

1) Maximum numbers are prepared based on assumption that all 2.2kW indoor units are connected. The numbers in parentheses means maximum connectable indoor units in accordance with outdoor units combination (160% - 200%). The recommended ratio is 130%.

2) Applying to 16, 18, 20HP outdoor units only.

ARUM240LTE6 / ARUM260LTE6 ARUM280LTE6 / ARUM300LTE6



HP			24	26	28	30
Classification	Chassis		UXC	UXC	UXB + UXA	UXB + UXA
	Combination Unit		ARUM240LTE6	ARUM260LTE6	ARUM160LTE6 ARUM120LTE6	ARUM180LTE6 ARUM120LTE6
Power Supply	V / Ø / Hz		380-415 / 3 / 50	380-415 / 3 / 50	380-415 / 3 / 50	380-415 / 3 / 50
Cooling Capacity	Rated	kW	67.2	72.8	78.4	84.0
	Heating Capacity					
Heating Capacity	Rated	kW	67.2	72.8	78.4	84.0
	Max	kW	75.6	81.9	88.2	94.5
Power Input (Cooling)	Rated	kW	26.15	31.52	27.10	26.04
Power Input (Heating)	Rated	kW	18.61	21.60	17.86	18.36
Efficiency	EER (Rated)	W/W	2.57	2.31	2.89	3.23
	COP (Rated)	W/W	3.61	3.37	4.39	4.58
	SEER	Wh/Wh	6.91	6.62	7.96	8.30
	SCOP	Wh/Wh	4.31	4.11	5.22	4.90
Outdoor Fan	Type		Propeller Fan	Propeller Fan	Propeller Fan	Propeller Fan
	Air Flow Rate (High)	m ³ /min x No.	430 x 1	430 x 1	(320 x 1) + (220 x 1)	(320 x 1) + (220 x 1)
	Discharge direction (Side / Top)		Top	Top	Top	Top
Outdoor Fan Motor	Drive		Direct	Direct	Direct	Direct
	Output	W x No.	1,500 x 2	1,500 x 2	(900 x 2) + (1,200 x 1)	(900 x 2) + (1,200 x 1)
Compressor	Type		Hermetically Sealed Scroll	Hermetically Sealed Scroll	Hermetically Sealed Scroll	Hermetically Sealed Scroll
	Piston Displacement	cm ³ /rev	62.1 x 2	62.1 x 2	62.1 x 2	62.1 x 3
	Number of Revolution	rev./min	3,600 x 2	3,600 x 2	3,600 x 2	3,600 x 3
	Motor Output	W x No.	5,300 x 2	5,300 x 2	5,300 x 2	5,300 x 3
	Oil Type		FW68L (PVE)	FW68L (PVE)	FW68L (PVE)	FW68L (PVE)
Heat Exchanger	Fin Type		Wide Louver Plus	Wide Louver Plus	Wide Louver Plus	Wide Louver Plus
Dimensions	Net (W x H x D)	mm	1,640 x 1,745 x 760	1,640 x 1,745 x 760	((1,240 x 1,745 x 760) x 1) + ((930 x 1,745 x 760) x 1)	((1,240 x 1,745 x 760) x 1) + ((930 x 1,745 x 760) x 1)
	Shipping (W x H x D)	mm	1,675 x 1,919 x 787	1,675 x 1,919 x 787	((1,282 x 1,919 x 802) x 1) + ((965 x 1,919 x 802) x 1)	((1,282 x 1,919 x 802) x 1) + ((965 x 1,919 x 802) x 1)
Weight	Net	kg	362	362	(255 x 1) + (215 x 1)	(300 x 1) + (215 x 1)
	Shipping	kg	372	372	(265 x 1) + (225 x 1)	(310 x 1) + (225 x 1)
Refrigerant	Type		R410A	R410A	R410A	R410A
	Precharged Amount	kg	16.0	16.0	22.5	25.5
	t-CO ₂ eq.		33.400	33.400	46.969	53.231
	Control Type		EEV	EEV	EEV	EEV
Connecting Pipe	Liquid	mm (inch)	Ø15.88 (5/8)	Ø19.05 (3/4)	Ø19.05 (3/4)	Ø19.05 (3/4)
	Gas	mm (inch)	Ø34.90 (1-3/8)	Ø34.90 (1-3/8)	Ø34.90 (1-3/8)	Ø34.90 (1-3/8)
	Low Pressure Gas (Heat Recovery)	mm (inch)	Ø34.90 (1-3/8)	Ø34.90 (1-3/8)	Ø34.90 (1-3/8)	Ø34.90 (1-3/8)
	High Pressure Gas (Heat Recovery)	mm (inch)	Ø28.58 (1-1/8)	Ø28.58 (1-1/8)	Ø28.58 (1-1/8)	Ø28.58 (1-1/8)
Sound Pressure Level (Outdoor Unit)	Cooling	dB (A)	65.0	65.0	62.8	63.1
	Heating	dB (A)	66.0	66.5	63.8	64.1
Sound Power Level (Outdoor Unit)	Cooling	dB (A)	85.0	89.0	86.2	86.2
	Heating	dB (A)	88.0	89.0	86.8	87.5
Connecting Cable	Communication Cable (VCTF-SB)	mm ² x cores	0.75 - 1.5 x 2C	0.75 - 1.5 x 2C	0.75 - 1.5 x 2C	0.75 - 1.5 x 2C
Connectable Indoor Units Number	Max. (Conditional)	EA	39 (61)	42 (64)	45 (56)	49 (60)

1) Maximum numbers are prepared based on assumption that all 2.2kW indoor units are connected. The numbers in parentheses means maximum connectable indoor units in accordance with outdoor units combination (160% - 200%). The recommended ratio is 130%.

**ARUM320LTE6 / ARUM340LTE6
ARUM360LTE6 / ARUM380LTE6**



HP			32	34	36	38
Classification	Chassis		UXB + UXA	UXB + UXB	UXB + UXB	UXB + UXB
	Combination Unit		ARUM200LTE6 ARUM120LTE6	ARUM200LTE6 ARUM140LTE6	ARUM200LTE6 ARUM160LTE6	ARUM200LTE6 ARUM180LTE6
Power Supply	V / Ø / Hz		380-415 / 3 / 50	380-415 / 3 / 50	380-415 / 3 / 50	380-415 / 3 / 50
Cooling Capacity	Rated	kW	89.6	95.2	100.8	106.4
	Heating Capacity	Rated	kW	89.6	95.2	100.8
Power Input (Cooling)	Rated	kW	29.19	29.42	32.99	31.93
	Rated	kW	20.41	21.07	22.73	23.23
Efficiency	EER (Rated)	W/W	3.07	3.24	3.06	3.33
	COP (Rated)	W/W	4.39	4.52	4.43	4.58
	SEER	Wh/Wh	8.18	8.48	8.19	8.53
	SCOP	Wh/Wh	5.06	5.15	5.29	4.97
Outdoor Fan	Type		Propeller Fan	Propeller Fan	Propeller Fan	Propeller Fan
	Air Flow Rate (High)	m ³ /min x No.	(320 × 1) + (220 × 1)	(320 × 1) + (320 × 1)	(320 × 1) + (320 × 1)	(320 × 1) + (320 × 1)
	Discharge direction (Side / Top)		Top	Top	Top	Top
Outdoor Fan Motor	Drive		Direct	Direct	Direct	Direct
	Output	W x No.	(900 × 2) + (1,200 × 1)	(900 × 2) + (900 × 2)	(900 × 2) + (900 × 2)	(900 × 2) + (900 × 2)
Compressor	Type		Hermetically Sealed Scroll	Hermetically Sealed Scroll	Hermetically Sealed Scroll	Hermetically Sealed Scroll
	Piston Displacement	cm ³ /rev	62.1 × 3	62.1 × 3	62.1 × 3	62.1 × 4
	Number of Revolution	rev./min	3,600 × 3	3,600 × 3	3,600 × 3	3,600 × 4
	Motor Output	W x No.	5,300 × 3	5,300 × 3	5,300 × 3	5,300 × 4
	Oil Type		FW68L (PVE)	FW68L (PVE)	FW68L (PVE)	FW68L (PVE)
Heat Exchanger	Fin Type		Wide Louver Plus	Wide Louver Plus	Wide Louver Plus	Wide Louver Plus
Dimensions	Net (W x H x D)	mm	((1,240 × 1,745 × 760) × 1) + ((930 × 1,745 × 760) × 1)	(1,240 × 1,745 × 760) × 2	(1,240 × 1,745 × 760) × 2	(1,240 × 1,745 × 760) × 2
	Shipping (W x H x D)	mm	((1,282 × 1,919 × 802) × 1) + ((965 × 1,919 × 802) × 1)	(1,282 × 1,919 × 802) × 2	(1,282 × 1,919 × 802) × 2	(1,282 × 1,919 × 802) × 2
Weight	Net	kg	(300 × 1) + (215 × 1)	(300 × 1) + (255 × 1)	(300 × 1) + (255 × 1)	(300 × 1) + (300 × 1)
	Shipping	kg	(310 × 1) + (225 × 1)	(310 × 1) + (265 × 1)	(310 × 1) + (265 × 1)	(310 × 1) + (310 × 1)
Refrigerant	Type		R410A	R410A	R410A	R410A
	Precharged Amount	kg	25.5	29.0	29.0	32.0
	t-CO ₂ eq.		53.231	60.538	60.538	66.800
	Control Type		EEV	EEV	EEV	EEV
Connecting Pipe	Liquid	mm (inch)	Ø19.05 (3/4)	Ø19.05 (3/4)	Ø19.05 (3/4)	Ø19.05 (3/4)
	Gas	mm (inch)	Ø34.90 (1-3/8)	Ø34.90 (1-3/8)	Ø41.30 (1-5/8)	Ø41.30 (1-5/8)
	Low Pressure Gas (Heat Recovery)	mm (inch)	Ø34.90 (1-3/8)	Ø34.90 (1-3/8)	Ø41.30 (1-5/8)	Ø41.30 (1-5/8)
	High Pressure Gas (Heat Recovery)	mm (inch)	Ø28.58 (1-1/8)	Ø28.58 (1-1/8)	Ø28.58 (1-1/8)	Ø34.90 (1-3/8)
Sound Pressure Level (Outdoor Unit)	Cooling	dB (A)	63.8	64.1	64.3	64.5
	Heating	dB (A)	65.1	65.4	65.6	65.8
Sound Power Level (Outdoor Unit)	Cooling	dB (A)	87.0	87.2	88.5	88.5
	Heating	dB (A)	89.8	89.6	90.5	90.8
Connecting Cable	Communication Cable (VCTF-SB)	mm ² × cores	0.75 - 1.5 × 2C	0.75 - 1.5 × 2C	0.75 - 1.5 × 2C	0.75 - 1.5 × 2C
Connectable Indoor Units Number	Max. (Conditional)	EA	52 (64)	55 (64)	58 (64)	61 (64)

1) Maximum numbers are prepared based on assumption that all 2.2kW indoor units are connected. The numbers in parentheses means maximum connectable indoor units in accordance with outdoor units combination (160% - 200%). The recommended ratio is 130%.

ARUM400LTE6 / ARUM420LTE6 ARUM440LTE6



HP			40	42	44
Classification	Chassis		UXB + UXB	UXC + UXB	UXC + UXB
	Combination Unit		ARUM200LTE6 ARUM200LTE6	ARUM220LTE6 ARUM200LTE6	ARUM240LTE6 ARUM200LTE6
Power Supply	V / Ø / Hz		380-415 / 3 / 50	380-415 / 3 / 50	380-415 / 3 / 50
Cooling Capacity	Rated	kW	112.0	117.6	123.2
	Rated	kW	112.0	117.6	123.2
Heating Capacity	Max	kW	126.0	132.3	138.6
	Rated	kW	35.08	39.54	43.69
Power Input (Cooling)	Rated	kW	25.28	28.60	31.25
Efficiency	EER (Rated)	W/W	3.19	2.97	2.82
	COP (Rated)	W/W	4.43	4.11	3.94
	SEER	Wh/Wh	8.42	7.81	7.66
	SCOP	Wh/Wh	5.13	4.87	4.72
Outdoor Fan	Type		Propeller Fan	Propeller Fan	Propeller Fan
	Air Flow Rate (High)	m³/min x No.	(320 x 1) + (320 x 1)	(430 x 1) + (320 x 1)	(430 x 1) + (320 x 1)
	Discharge direction (Side / Top)		Top	Top	Top
Outdoor Fan Motor	Drive		Direct	Direct	Direct
	Output	W x No.	(900 x 2) + (900 x 2)	(1,500 x 2) + (900 x 2)	(1,500 x 2) + (900 x 2)
Compressor	Type		Hermetically Sealed Scroll	Hermetically Sealed Scroll	Hermetically Sealed Scroll
	Piston Displacement	cm³/rev	62.1 x 4	62.1 x 4	62.1 x 4
	Number of Revolution	rev./min	3,600 x 4	3,600 x 4	3,600 x 4
	Motor Output	W x No.	5,300 x 4	5,300 x 4	5,300 x 4
	Oil Type		FW68L (PVE)	FW68L (PVE)	FW68L (PVE)
Heat Exchanger	Fin Type		Wide Louver Plus	Wide Louver Plus	Wide Louver Plus
Dimensions	Net (W x H x D)	mm	(1,240 x 1,745 x 760) x 2	((1,640 x 1,745 x 760) x 1) + ((1,240 x 1,745 x 760) x 1)	((1,640 x 1,745 x 760) x 1) + ((1,240 x 1,745 x 760) x 1)
	Shipping (W x H x D)	mm	(1,282 x 1,919 x 802) x 2	((1,675 x 1,919 x 802) x 1) + ((1,282 x 1,919 x 802) x 1)	((1,675 x 1,919 x 802) x 1) + ((1,282 x 1,919 x 802) x 1)
Weight	Net	kg	(300 x 1) + (300 x 1)	(362 x 1) + (300 x 1)	(362 x 1) + (300 x 1)
	Shipping	kg	(310 x 1) + (310 x 1)	(372 x 1) + (310 x 1)	(372 x 1) + (310 x 1)
Refrigerant	Type		R410A	R410A	R410A
	Precharged Amount	kg	32.0	32.0	32.0
	t-CO ₂ eq.		66.800	66.800	66.800
	Control Type		EEV	EEV	EEV
Connecting Pipe	Liquid	mm (inch)	Ø19.05 (3/4)	Ø19.05 (3/4)	Ø19.05 (3/4)
	Gas	mm (inch)	Ø41.30 (1-5/8)	Ø41.30 (1-5/8)	Ø41.30 (1-5/8)
	Low Pressure Gas (Heat Recovery)	mm (inch)	Ø41.30 (1-5/8)	Ø41.30 (1-5/8)	Ø41.30 (1-5/8)
	High Pressure Gas (Heat Recovery)	mm (inch)	Ø34.90 (1-3/8)	Ø34.90 (1-3/8)	Ø34.90 (1-3/8)
Sound Pressure Level (Outdoor Unit)	Cooling	dB (A)	65.0	66.1	66.8
	Heating	dB (A)	66.5	67.9	67.9
Sound Power Level (Outdoor Unit)	Cooling	dB (A)	89.0	88.1	88.5
	Heating	dB (A)	92.0	91.5	91.5
Connecting Cable	Communication Cable (VCTF-SB)	mm² x cores	0.75 - 1.5 x 2C	0.75 - 1.5 x 2C	0.75 - 1.5 x 2C
Connectable Indoor Units Number	Max. (Conditional)	EA	64	64	64

1) Maximum numbers are prepared based on assumption that all 2.2kW indoor units are connected. The numbers in parentheses means maximum connectable indoor units in accordance with outdoor units combination (160% - 200%). The recommended ratio is 130%.

ARUM460LTE6 / ARUM480LTE6 ARUM500LTE6



HP			46	48	50
Classification	Chassis		UXC + UXC	UXC + UXC	UXB + UXB + UXA
	Combination Unit		ARUM240LTE6 ARUM220LTE6	ARUM240LTE6 ARUM240LTE6	ARUM200LTE6 ARUM180LTE6 ARUM120LTE6
Power Supply	V / Ø / Hz		380-415 / 3 / 50	380-415 / 3 / 50	380-415 / 3 / 50
Cooling Capacity	Rated	kW	128.8	134.4	140.0
	Heating Capacity	Max	144.9	151.2	157.5
Power Input (Cooling)	Rated	kW	48.15	52.30	43.58
	Rated	kW	34.57	37.22	31.00
Efficiency	EER (Rated)	W/W	2.67	2.57	3.21
	COP (Rated)	W/W	3.73	3.61	4.52
	SEER	Wh/Wh	7.06	6.91	8.34
	SCOP	Wh/Wh	4.47	4.31	4.97
Outdoor Fan	Type		Propeller Fan	Propeller Fan	Propeller Fan
	Air Flow Rate (High)	m ³ /min x No.	(430 x 1) + (430 x 1)	(430 x 1) + (430 x 1)	(320 x 1) + (320 x 1) + (220 x 1)
	Discharge direction (Side / Top)		Top	Top	Top
Outdoor Fan Motor	Drive		Direct	Direct	Direct
	Output	W x No.	(1,500 x 2) + (1,500 x 2)	(1,500 x 2) + (1,500 x 2)	(900 x 2) + (900 x 2) + (1,200 x 1)
Compressor	Type		Hermetically Sealed Scroll	Hermetically Sealed Scroll	Hermetically Sealed Scroll
	Piston Displacement	cm ³ /rev	62.1 x 4	62.1 x 4	62.1 x 5
	Number of Revolution	rev./min	3,600 x 4	3,600 x 4	3,600 x 5
	Motor Output	W x No.	5,300 x 4	5,300 x 4	5,300 x 5
	Oil Type		FW68L (PVE)	FW68L (PVE)	FW68L (PVE)
Heat Exchanger	Fin Type		Wide Louver Plus	Wide Louver Plus	Wide Louver Plus
Dimensions	Net (W x H x D)	mm	(1,640 x 1,745 x 760) x 2	(1,640 x 1,745 x 760) x 2	((1,240 x 1,745 x 760) x 2) + ((930 x 1,745 x 760) x 1)
	Shipping (W x H x D)	mm	(1,675 x 1,919 x 802) x 2	(1,675 x 1,919 x 802) x 2	((1,282 x 1,919 x 802) x 2) + ((965 x 1,919 x 802) x 1)
Weight	Net	kg	(362 x 1) + (362 x 1)	(362 x 1) + (362 x 1)	(300 x 1) + (300 x 1) + (215 x 1)
	Shipping	kg	(372 x 1) + (372 x 1)	(372 x 1) + (372 x 1)	(310 x 1) + (310 x 1) + (225 x 1)
Refrigerant	Type		R410A	R410A	R410A
	Precharged Amount	kg	32.0	32.0	41.5
	t-CO ₂ eq.		66.800	66.800	86.631
	Control Type		EEV	EEV	EEV
Connecting Pipe	Liquid	mm (inch)	Ø19.05 (3/4)	Ø19.05 (3/4)	Ø19.05 (3/4)
	Gas	mm (inch)	Ø41.30 (1-5/8)	Ø41.30 (1-5/8)	Ø41.30 (1-5/8)
	Low Pressure Gas (Heat Recovery)	mm (inch)	Ø41.30 (1-5/8)	Ø41.30 (1-5/8)	Ø41.30 (1-5/8)
	High Pressure Gas (Heat Recovery)	mm (inch)	Ø34.90 (1-3/8)	Ø34.90 (1-3/8)	Ø34.90 (1-3/8)
Sound Pressure Level (Outdoor Unit)	Cooling	dB (A)	67.5	68.0	65.6
	Heating	dB (A)	69.0	69.0	66.8
Sound Power Level (Outdoor Unit)	Cooling	dB (A)	87.5	88.0	89.1
	Heating	dB (A)	91.0	91.0	91.3
Connecting Cable	Communication Cable (VCTF-SB)	mm ² x cores	0.75 - 1.5 x 2C	0.75 - 1.5 x 2C	0.75 - 1.5 x 2C
Connectable Indoor Units Number	Max. (Conditional)	EA	64	64	64

1) Maximum numbers are prepared based on assumption that all 2.2kW indoor units are connected. The numbers in parentheses means maximum connectable indoor units in accordance with outdoor units combination (160% - 200%). The recommended ratio is 130%.

ARUM520LTE6 / ARUM540LTE6 ARUM560LTE6



HP			52	54	56
Classification	Chassis		UXB + UXB + UXA	UXB + UXB + UXB	UXB + UXB + UXB
	Combination Unit		ARUM200LTE6 ARUM200LTE6 ARUM120LTE6	ARUM200LTE6 ARUM200LTE6 ARUM140LTE6	ARUM200LTE6 ARUM200LTE6 ARUM160LTE6
Power Supply	V / Ø / Hz		380-415 / 3 / 50	380-415 / 3 / 50	380-415 / 3 / 50
Cooling Capacity	Rated	kW	145.6	151.2	156.8
	Heating Capacity				
Heating Capacity	Rated	kW	145.6	151.2	156.8
	Max	kW	163.8	170.1	176.4
Power Input (Cooling)	Rated	kW	46.73	46.96	50.53
Power Input (Heating)	Rated	kW	33.05	33.71	35.37
Efficiency	EER (Rated)	W/W	3.12	3.22	3.10
	COP (Rated)	W/W	4.41	4.49	4.43
	SEER	Wh/Wh	8.26	8.46	8.27
	SCOP	Wh/Wh	5.08	5.14	5.24
Outdoor Fan	Type		Propeller Fan	Propeller Fan	Propeller Fan
	Air Flow Rate (High)	m³/min x No.	(320 × 1) + (320 × 1) + (220 × 1)	(320 × 1) + (320 × 1) + (320 × 1)	(320 × 1) + (320 × 1) + (320 × 1)
	Discharge direction (Side / Top)		Top	Top	Top
Outdoor Fan Motor	Drive		Direct	Direct	Direct
	Output	W x No.	(900 × 2) + (900 × 2) + (1,200 × 1)	(900 × 2) + (900 × 2) + (900 × 2)	(900 × 2) + (900 × 2) + (900 × 2)
Compressor	Type		Hermetically Sealed Scroll	Hermetically Sealed Scroll	Hermetically Sealed Scroll
	Piston Displacement	cm³/rev	62.1 × 5	62.1 × 5	62.1 × 5
	Number of Revolution	rev./min	3,600 × 5	3,600 × 5	3,600 × 5
	Motor Output	W x No.	5,300 × 5	5,300 × 5	5,300 × 5
	Oil Type		FW68L (PVE)	FW68L (PVE)	FW68L (PVE)
Heat Exchanger	Fin Type		Wide Louver Plus	Wide Louver Plus	Wide Louver Plus
Dimensions	Net (W x H x D)	mm	((1,240 × 1,745 × 760) × 2) + ((930 × 1,745 × 760) × 1)	(1,240 × 1,745 × 760) × 3	(1,240 × 1,745 × 760) × 3
	Shipping (W x H x D)	mm	((1,282 × 1,919 × 802) × 2) + ((965 × 1,919 × 802) × 1)	(1,282 × 1,919 × 802) × 3	(1,282 × 1,919 × 802) × 3
Weight	Net	kg	(300 × 1) + (300 × 1) + (215 × 1)	(300 × 1) + (300 × 1) + (255 × 1)	(300 × 1) + (300 × 1) + (255 × 1)
	Shipping	kg	(310 × 1) + (310 × 1) + (225 × 1)	(310 × 1) + (310 × 1) + (265 × 1)	(310 × 1) + (310 × 1) + (265 × 1)
Refrigerant	Type		R410A	R410A	R410A
	Precharged Amount	kg	41.5	45.0	45.0
	t-CO ₂ eq.		86.631	93.938	93.938
	Control Type		EEV	EEV	EEV
Connecting Pipe	Liquid	mm (inch)	Ø19.05 (3/4)	Ø19.05 (3/4)	Ø19.05 (3/4)
	Gas	mm (inch)	Ø41.30 (1-5/8)	Ø41.30 (1-5/8)	Ø41.30 (1-5/8)
	Low Pressure Gas (Heat Recovery)	mm (inch)	Ø41.30 (1-5/8)	Ø41.30 (1-5/8)	Ø41.30 (1-5/8)
	High Pressure Gas (Heat Recovery)	mm (inch)	Ø34.90 (1-3/8)	Ø34.90 (1-3/8)	Ø34.90 (1-3/8)
Sound Pressure Level (Outdoor Unit)	Cooling	dB (A)	66.0	66.2	66.3
	Heating	dB (A)	67.4	67.6	67.7
Sound Power Level (Outdoor Unit)	Cooling	dB (A)	89.5	89.6	90.5
	Heating	dB (A)	92.4	92.3	92.8
Connecting Cable	Communication Cable (VCTF-SB)	mm² × cores	0.75 ~ 1.5 × 2C	0.75 ~ 1.5 × 2C	0.75 ~ 1.5 × 2C
Connectable Indoor Units Number	Max. (Conditional)	EA	64	64	64

1) Maximum numbers are prepared based on assumption that all 2.2kW indoor units are connected. The numbers in parentheses means maximum connectable indoor units in accordance with outdoor units combination (160% ~ 200%). The recommended ratio is 130%.

ARUM58OLTE6 / ARUM60OLTE6 ARUM62OLTE6



HP			58	60	62
Classification	Chassis		UXB + UXB + UXB	UXB + UXB + UXB	UXC + UXB + UXB
	Combination Unit		ARUM200LTE6 ARUM200LTE6 ARUM180LTE6	ARUM200LTE6 ARUM200LTE6 ARUM200LTE6	ARUM220LTE6 ARUM200LTE6 ARUM200LTE6
Power Supply	V / Ø / Hz		380-415 / 3 / 50	380-415 / 3 / 50	380-415 / 3 / 50
Cooling Capacity	Rated	kW	162.4	168.0	173.6
	Heating Capacity	Max	182.7	189.0	195.3
Power Input (Cooling)	Rated	kW	49.47	52.62	57.08
Power Input (Heating)	Rated	kW	35.87	37.92	41.24
Efficiency	EER (Rated)	W/W	3.28	3.19	3.04
	COP (Rated)	W/W	4.53	4.43	4.21
	SEER	Wh/Wh	8.49	8.42	8.01
	SCOP	Wh/Wh	5.02	5.13	4.96
Outdoor Fan	Type		Propeller Fan	Propeller Fan	Propeller Fan
	Air Flow Rate (High)	m³/min x No.	(320 × 1) + (320 × 1) + (320 × 1)	(320 × 1) + (320 × 1) + (320 × 1)	(430 × 1) + (320 × 1) + (320 × 1)
	Discharge direction (Side / Top)		Top	Top	Top
Outdoor Fan Motor	Drive		Direct	Direct	Direct
	Output	W x No.	(900 × 2) + (900 × 2) + (900 × 2)	(900 × 2) + (900 × 2) + (900 × 2)	(1,500 × 2) + (900 × 2) + (900 × 2)
Compressor	Type		Hermetically Sealed Scroll	Hermetically Sealed Scroll	Hermetically Sealed Scroll
	Piston Displacement	cm³/rev	62.1 × 6	62.1 × 6	62.1 × 6
	Number of Revolution	rev./min	3,600 × 6	3,600 × 6	3,600 × 6
	Motor Output	W x No.	5,300 × 6	5,300 × 6	5,300 × 6
	Oil Type		FW68L (PVE)	FW68L (PVE)	FW68L (PVE)
Heat Exchanger	Fin Type		Wide Louver Plus	Wide Louver Plus	Wide Louver Plus
Dimensions	Net (W x H x D)	mm	(1,240 × 1,745 × 760) × 3	(1,240 × 1,745 × 760) × 3	((1,640 × 1,745 × 760) × 1) + ((1,240 × 1,745 × 760) × 2)
	Shipping (W x H x D)	mm	(1,282 × 1,919 × 802) × 3	(1,282 × 1,919 × 802) × 3	((1,675 × 1,919 × 802) × 1) + ((1,282 × 1,919 × 802) × 2)
Weight	Net	kg	(300 × 1) + (300 × 1) + (300 × 1)	(300 × 1) + (300 × 1) + (300 × 1)	(362 × 1) + (300 × 1) + (300 × 1)
	Shipping	kg	(310 × 1) + (310 × 1) + (310 × 1)	(310 × 1) + (310 × 1) + (310 × 1)	(372 × 1) + (310 × 1) + (310 × 1)
Refrigerant	Type		R410A	R410A	R410A
	Precharged Amount	kg	48.0	48.0	48.0
	t-CO ₂ eq.		100.200	100.200	100.200
	Control Type		EEV	EEV	EEV
Connecting Pipe	Liquid	mm (inch)	Ø19.05 (3/4)	Ø19.05 (3/4)	Ø22.20 (7/8)
	Gas	mm (inch)	Ø41.30 (1-5/8)	Ø41.30 (1-5/8)	Ø41.30 (1-5/8)
	Low Pressure Gas (Heat Recovery)	mm (inch)	Ø41.30 (1-5/8)	Ø41.30 (1-5/8)	Ø41.30 (1-5/8)
	High Pressure Gas (Heat Recovery)	mm (inch)	Ø34.90 (1-3/8)	Ø34.90 (1-3/8)	Ø34.90 (1-3/8)
Sound Pressure Level (Outdoor Unit)	Cooling	dB (A)	66.5	66.8	67.5
	Heating	dB (A)	67.8	68.3	69.3
Sound Power Level (Outdoor Unit)	Cooling	dB (A)	90.5	90.8	90.2
	Heating	dB (A)	93.0	93.8	93.5
Connecting Cable	Communication Cable (VCTF-SB)	mm² × cores	0.75 - 1.5 × 2C	0.75 - 1.5 × 2C	0.75 - 1.5 × 2C
Connectable Indoor Units Number	Max. (Conditional)	EA	64	64	64

1) Maximum numbers are prepared based on assumption that all 2.2kW indoor units are connected. The numbers in parentheses means maximum connectable indoor units in accordance with outdoor units combination (160% - 200%). The recommended ratio is 130%.

ARUM64OLTE6 / ARUM66OLTE6 ARUM68OLTE6



HP			64	66	68
Classification	Chassis		UXC + UXB + UXB	UXC + UXC + UXB	UXC + UXC + UXB
	Combination Unit		ARUM240LTE6 ARUM200LTE6 ARUM200LTE6	ARUM240LTE6 ARUM220LTE6 ARUM200LTE6	ARUM240LTE6 ARUM240LTE6 ARUM200LTE6
Power Supply	V / Ø / Hz		380-415 / 3 / 50	380-415 / 3 / 50	380-415 / 3 / 50
Cooling Capacity	Rated	kW	179.2	184.8	190.4
	Heating Capacity	Max	201.6	207.9	214.2
Power Input (Cooling)	Rated	kW	61.23	65.69	69.84
Power Input (Heating)	Rated	kW	43.89	47.21	49.86
Efficiency	EER (Rated)	W/W	2.93	2.81	2.73
	COP (Rated)	W/W	4.08	3.91	3.82
	SEER	Wh/Wh	7.91	7.51	7.41
	SCOP	Wh/Wh	4.86	4.69	4.58
Outdoor Fan	Type		Propeller Fan	Propeller Fan	Propeller Fan
	Air Flow Rate (High)	m³/min x No.	(430 x 1) + (320 x 1) + (320 x 1)	(430 x 1) + (430 x 1) + (320 x 1)	(430 x 1) + (430 x 1) + (320 x 1)
	Discharge direction (Side / Top)		Top	Top	Top
Outdoor Fan Motor	Drive		Direct	Direct	Direct
	Output	W x No.	(1,500 x 2) + (900 x 2) + (900 x 2)	(1,500 x 2) + (1,500 x 2) + (900 x 2)	(1,500 x 2) + (1,500 x 2) + (900 x 2)
Compressor	Type		Hermetically Sealed Scroll	Hermetically Sealed Scroll	Hermetically Sealed Scroll
	Piston Displacement	cm³/rev	62.1 x 6	62.1 x 6	62.1 x 6
	Number of Revolution	rev./min	3,600 x 6	3,600 x 6	3,600 x 6
	Motor Output	W x No.	5,300 x 6	5,300 x 6	5,300 x 6
	Oil Type		FW68L (PVE)	FW68L (PVE)	FW68L (PVE)
Heat Exchanger	Fin Type		Wide Louver Plus	Wide Louver Plus	Wide Louver Plus
Dimensions	Net (W x H x D)	mm	((1,640 x 1,745 x 760) x 1) + ((1,240 x 1,745 x 760) x 2)	((1,640 x 1,745 x 760) x 2) + ((1,240 x 1,745 x 760) x 1)	((1,640 x 1,745 x 760) x 2) + ((1,240 x 1,745 x 760) x 1)
	Shipping (W x H x D)	mm	((1,675 x 1,919 x 802) x 1) + ((1,282 x 1,919 x 802) x 2)	((1,675 x 1,919 x 802) x 2) + ((1,282 x 1,919 x 802) x 1)	((1,675 x 1,919 x 802) x 2) + ((1,282 x 1,919 x 802) x 1)
Weight	Net	kg	(362 x 1) + (300 x 1) + (300 x 1)	(362 x 1) + (362 x 1) + (300 x 1)	(362 x 1) + (362 x 1) + (300 x 1)
	Shipping	kg	(372 x 1) + (310 x 1) + (310 x 1)	(372 x 1) + (372 x 1) + (310 x 1)	(372 x 1) + (372 x 1) + (310 x 1)
Refrigerant	Type		R410A	R410A	R410A
	Precharged Amount	kg	48.0	48.0	48.0
	t-CO ₂ eq.		100.200	100.200	100.200
	Control Type		EEV	EEV	EEV
Connecting Pipe	Liquid	mm (inch)	Ø22.20 (7/8)	Ø22.20 (7/8)	Ø22.20 (7/8)
	Gas	mm (inch)	Ø41.30 (1-5/8)	Ø53.98 (2-1/8)	Ø53.98 (2-1/8)
	Low Pressure Gas (Heat Recovery)	mm (inch)	Ø41.30 (1-5/8)	Ø53.98 (2-1/8)	Ø53.98 (2-1/8)
	High Pressure Gas (Heat Recovery)	mm (inch)	Ø34.90 (1-3/8)	Ø41.30 (1-5/8)	Ø41.30 (1-5/8)
Sound Pressure Level (Outdoor Unit)	Cooling	dB (A)	68.0	68.6	69.0
	Heating	dB (A)	69.3	70.1	70.1
Sound Power Level (Outdoor Unit)	Cooling	dB (A)	90.5	89.8	90.1
	Heating	dB (A)	93.5	93.1	93.1
Connecting Cable	Communication Cable (VCTF-SB)	mm² x cores	0.75 - 1.5 x 2C	0.75 - 1.5 x 2C	0.75 - 1.5 x 2C
Connectable Indoor Units Number	Max. (Conditional)	EA	64	64	64

1) Maximum numbers are prepared based on assumption that all 2.2kW indoor units are connected. The numbers in parentheses means maximum connectable indoor units in accordance with outdoor units combination (160% - 200%). The recommended ratio is 130%.

ARUM700LTE6 / ARUM720LTE6 ARUM740LTE6



HP			70	72	74
Classification	Chassis		UXB + UXB + UXB + UXA	UXB + UXB + UXB + UXA	UXB + UXB + UXB + UXB
	Combination Unit		ARUM200LTE6 ARUM200LTE6 ARUM180LTE6 ARUM120LTE6	ARUM200LTE6 ARUM200LTE6 ARUM200LTE6 ARUM120LTE6	ARUM200LTE6 ARUM200LTE6 ARUM200LTE6 ARUM140LTE6
Power Supply	V / Ø / Hz		380-415 / 3 / 50	380-415 / 3 / 50	380-415 / 3 / 50
Cooling Capacity	Rated	kW	196.0	201.6	207.2
	Heating Capacity	Rated	kW	196.0	201.6
Heating Capacity	Max	kW	220.5	226.8	233.1
	Rated	kW	61.12	64.27	64.50
Power Input (Cooling)	Rated	kW	43.64	45.69	46.35
Efficiency	EER (Rated)	W/W	3.21	3.14	3.21
	COP (Rated)	W/W	4.49	4.41	4.47
	SEER	Wh/Wh	8.36	8.30	8.45
	SCOP	Wh/Wh	5.01	5.09	5.14
Outdoor Fan	Type		Propeller Fan	Propeller Fan	Propeller Fan
	Air Flow Rate (High)	m ³ /min x No.	(320 × 1) + (320 × 1) + (320 × 1) + (220 × 1)	(320 × 1) + (320 × 1) + (320 × 1) + (220 × 1)	(320 × 1) + (320 × 1) + (320 × 1) + (320 × 1)
	Discharge direction (Side / Top)		Top	Top	Top
Outdoor Fan Motor	Drive		Direct	Direct	Direct
	Output	W x No.	(900 × 2) + (900 × 2) + (900 × 2) + (1,200 × 1)	(900 × 2) + (900 × 2) + (900 × 2) + (1,200 × 1)	(900 × 2) + (900 × 2) + (900 × 2) + (900 × 2)
Compressor	Type		Hermetically Sealed Scroll	Hermetically Sealed Scroll	Hermetically Sealed Scroll
	Piston Displacement	cm ³ /rev	62.1 × 7	62.1 × 7	62.1 × 7
	Number of Revolution	rev./min	3,600 × 7	3,600 × 7	3,600 × 7
	Motor Output	W x No.	5,300 × 7	5,300 × 7	5,300 × 7
Heat Exchanger	Oil Type		FW68L (PVE)	FW68L (PVE)	FW68L (PVE)
	Fin Type		Wide Louver Plus	Wide Louver Plus	Wide Louver Plus
Dimensions	Net (W x H x D)	mm	((1,240 × 1,745 × 760) × 3) + ((930 × 1,745 × 760) × 1)	((1,240 × 1,745 × 760) × 3) + ((930 × 1,745 × 760) × 1)	(1,240 × 1,745 × 760) × 4
	Shipping (W x H x D)	mm	((1,282 × 1,919 × 802) × 3) + ((965 × 1,919 × 802) × 1)	((1,282 × 1,919 × 802) × 3) + ((965 × 1,919 × 802) × 1)	(1,282 × 1,919 × 802) × 4
Weight	Net	kg	(300 × 1) + (300 × 1) + (300 × 1) + (215 × 1)	(300 × 1) + (300 × 1) + (300 × 1) + (215 × 1)	(300 × 1) + (300 × 1) + (300 × 1) + (255 × 1)
	Shipping	kg	(310 × 1) + (310 × 1) + (310 × 1) + (225 × 1)	(310 × 1) + (310 × 1) + (310 × 1) + (225 × 1)	(310 × 1) + (310 × 1) + (310 × 1) + (265 × 1)
Refrigerant	Type		R410A	R410A	R410A
	Precharged Amount	kg	57.5	57.5	61.0
	t-CO ₂ eq.		120.031	120.031	127.338
	Control Type		EEV	EEV	EEV
Connecting Pipe	Liquid	mm (inch)	Ø22.20 (7/8)	Ø22.20 (7/8)	Ø22.20 (7/8)
	Gas	mm (inch)	Ø53.98 (2-1/8)	Ø53.98 (2-1/8)	Ø53.98 (2-1/8)
	Low Pressure Gas (Heat Recovery)	mm (inch)	Ø53.98 (2-1/8)	Ø53.98 (2-1/8)	Ø53.98 (2-1/8)
	High Pressure Gas (Heat Recovery)	mm (inch)	Ø41.30 (1-5/8)	Ø41.30 (1-5/8)	Ø41.30 (1-5/8)
Sound Pressure Level (Outdoor Unit)	Cooling	dB (A)	67.2	67.4	67.6
	Heating	dB (A)	68.5	68.9	69.0
Sound Power Level (Outdoor Unit)	Cooling	dB (A)	90.8	91.1	91.2
	Heating	dB (A)	93.3	94.1	94.0
Connecting Cable	Communication Cable (VCTF-SB)	mm ² × cores	0.75 - 1.5 × 2C	0.75 - 1.5 × 2C	0.75 - 1.5 × 2C
Connectable Indoor Units Number	Max. (Conditional)	EA	64	64	64

1) Maximum numbers are prepared based on assumption that all 2.2kW indoor units are connected. The numbers in parentheses means maximum connectable indoor units in accordance with outdoor units combination (160% - 200%). The recommended ratio is 130%.

ARUM760LTE6 / ARUM780LTE6 ARUM800LTE6



HP			76	78	80
Classification	Chassis		UXB + UXB + UXB + UXB	UXB + UXB + UXB + UXB	UXB + UXB + UXB + UXB
	Combination Unit		ARUM200LTE6 ARUM200LTE6 ARUM200LTE6 ARUM160LTE6	ARUM200LTE6 ARUM200LTE6 ARUM200LTE6 ARUM180LTE6	ARUM200LTE6 ARUM200LTE6 ARUM200LTE6 ARUM200LTE6
Power Supply	V / Ø / Hz		380-415 / 3 / 50	380-415 / 3 / 50	380-415 / 3 / 50
Cooling Capacity	Rated	kW	212.8	218.4	224.0
	Heating Capacity	Rated	kW	212.8	218.4
Capacity	Max	kW	239.4	245.7	252.0
	Power Input (Cooling)	Rated	kW	68.07	67.01
Power Input (Heating)	Rated	kW	48.01	48.51	50.56
	EER (Rated)	W/W	3.13	3.26	3.19
Efficiency	COP (Rated)	W/W	4.43	4.50	4.43
	SEER	Wh/Wh	8.30	8.47	8.42
	SCOP	Wh/Wh	5.21	5.05	5.13
	Type		Propeller Fan	Propeller Fan	Propeller Fan
Outdoor Fan	Air Flow Rate (High)	m ³ /min x No.	(320 × 1) + (320 × 1) + (320 × 1) + (320 × 1)	(320 × 1) + (320 × 1) + (320 × 1) + (320 × 1)	(320 × 1) + (320 × 1) + (320 × 1) + (320 × 1)
	Discharge direction (Side / Top)		Top	Top	Top
Outdoor Fan Motor	Drive		Direct	Direct	Direct
	Output	W x No.	(900 × 2) + (900 × 2) + (900 × 2) + (900 × 2)	(900 × 2) + (900 × 2) + (900 × 2) + (900 × 2)	(900 × 2) + (900 × 2) + (900 × 2) + (900 × 2)
Compressor	Type		Hermetically Sealed Scroll	Hermetically Sealed Scroll	Hermetically Sealed Scroll
	Piston Displacement	cm ³ /rev	62.1 × 7	62.1 × 8	62.1 × 8
	Number of Revolution	rev./min	3,600 × 7	3,600 × 8	3,600 × 8
	Motor Output	W x No.	5,300 × 7	5,300 × 8	5,300 × 8
	Oil Type		FW68L (PVE)	FW68L (PVE)	FW68L (PVE)
Heat Exchanger	Fin Type		Wide Louver Plus	Wide Louver Plus	Wide Louver Plus
Dimensions	Net (W x H x D)	mm	(1,240 × 1,745 × 760) × 4	(1,240 × 1,745 × 760) × 4	(1,240 × 1,745 × 760) × 4
	Shipping (W x H x D)	mm	(1,282 × 1,919 × 802) × 4	(1,282 × 1,919 × 802) × 4	(1,282 × 1,919 × 802) × 4
Weight	Net	kg	(300 × 1) + (300 × 1) + (300 × 1) + (255 × 1)	(300 × 1) + (300 × 1) + (300 × 1) + (300 × 1)	(300 × 1) + (300 × 1) + (300 × 1) + (300 × 1)
	Shipping	kg	(310 × 1) + (310 × 1) + (310 × 1) + (265 × 1)	(310 × 1) + (310 × 1) + (310 × 1) + (310 × 1)	(310 × 1) + (310 × 1) + (310 × 1) + (310 × 1)
Refrigerant	Type		R410A	R410A	R410A
	Precharged Amount	kg	61.0	64.0	64.0
	t-CO ₂ eq.		127.338	133.600	133.600
	Control Type		EEV	EEV	EEV
Connecting Pipe	Liquid	mm (inch)	Ø22.20 (7/8)	Ø22.20 (7/8)	Ø22.20 (7/8)
	Gas	mm (inch)	Ø53.98 (2-1/8)	Ø53.98 (2-1/8)	Ø53.98 (2-1/8)
	Low Pressure Gas (Heat Recovery)	mm (inch)	Ø53.98 (2-1/8)	Ø53.98 (2-1/8)	Ø53.98 (2-1/8)
	High Pressure Gas (Heat Recovery)	mm (inch)	Ø41.30 (1-5/8)	Ø41.30 (1-5/8)	Ø41.30 (1-5/8)
Sound Pressure Level (Outdoor Unit)	Cooling	dB (A)	67.7	67.8	68.0
	Heating	dB (A)	69.1	69.2	69.5
Sound Power Level (Outdoor Unit)	Cooling	dB (A)	91.8	91.8	92.0
	Heating	dB (A)	94.3	94.4	95.0
Connecting Cable	Communication Cable (VCTF-SB)	mm ² × cores	0.75 - 1.5 × 2C	0.75 - 1.5 × 2C	0.75 - 1.5 × 2C
Connectable Indoor Units Number	Max. (Conditional)	EA	64	64	64

1) Maximum numbers are prepared based on assumption that all 2.2kW indoor units are connected. The numbers in parentheses means maximum connectable indoor units in accordance with outdoor units combination (160% - 200%). The recommended ratio is 130%.

ARUM820LTE6 / ARUM840LTE6



HP			82	84
Classification	Chassis		UXC + UXC + UXB + UXB	UXC + UXC + UXB + UXB
	Combination Unit		ARUM240LTE6 ARUM240LTE6 ARUM200LTE6 ARUM140LTE6	ARUM240LTE6 ARUM240LTE6 ARUM200LTE6 ARUM160LTE6
Power Supply	V / Ø / Hz		380-415 / 3 / 50	380-415 / 3 / 50
Cooling Capacity	Rated	kW	229.6	235.2
Heating Capacity	Rated	kW	229.6	235.2
	Max	kW	258.3	264.6
Power Input (Cooling)	Rated	kW	81.72	85.29
Power Input (Heating)	Rated	kW	58.29	59.95
Efficiency	EER (Rated)	W/W	2.81	2.76
	COP (Rated)	W/W	3.94	3.92
	SEER	Wh/Wh	7.70	7.55
	SCOP	Wh/Wh	4.73	4.80
Outdoor Fan	Type		Propeller Fan	Propeller Fan
	Air Flow Rate (High)	m ³ /min x No.	(430 x 1) + (430 x 1) + (320 x 1) + (320 x 1)	(430 x 1) + (430 x 1) + (320 x 1) + (320 x 1)
	Discharge direction (Side / Top)		Top	Top
Outdoor Fan Motor	Drive		Direct	Direct
	Output	W x No.	(1,500 x 2) + (1,500 x 2) + (900 x 2) + (900 x 2)	(1,500 x 2) + (1,500 x 2) + (900 x 2) + (900 x 2)
Compressor	Type		Hermetically Sealed Scroll	Hermetically Sealed Scroll
	Piston Displacement	cm ³ /rev	62.1 x 7	62.1 x 7
	Number of Revolution	rev./min	3,600 x 7	3,600 x 7
	Motor Output	W x No.	5,300 x 7	5,300 x 7
	Oil Type		FW68L (PVE)	FW68L (PVE)
Heat Exchanger	Fin Type		Wide Louver Plus	Wide Louver Plus
Dimensions	Net (W x H x D)	mm	((1,640 x 1,745 x 760) x 2) + ((1,240 x 1,745 x 760) x 2)	((1,640 x 1,745 x 760) x 2) + ((1,240 x 1,745 x 760) x 2)
	Shipping (W x H x D)	mm	((1,675 x 1,919 x 802) x 2) + ((1,282 x 1,919 x 802) x 2)	((1,675 x 1,919 x 802) x 2) + ((1,282 x 1,919 x 802) x 2)
Weight	Net	kg	(362 x 1) + (362 x 1) + (300 x 1) + (255 x 1)	(362 x 1) + (362 x 1) + (300 x 1) + (255 x 1)
	Shipping	kg	(372 x 1) + (372 x 1) + (310 x 1) + (265 x 1)	(372 x 1) + (372 x 1) + (310 x 1) + (265 x 1)
Refrigerant	Type		R410A	R410A
	Precharged Amount	kg	61.0	61.0
	t-CO ₂ eq.		127.338	127.338
	Control Type		EEV	EEV
Connecting Pipe	Liquid	mm (inch)	Ø22.20 (7/8)	Ø22.20 (7/8)
	Gas	mm (inch)	Ø53.98 (2-1/8)	Ø53.98 (2-1/8)
	Low Pressure Gas (Heat Recovery)	mm (inch)	Ø53.98 (2-1/8)	Ø53.98 (2-1/8)
	High Pressure Gas (Heat Recovery)	mm (inch)	Ø41.30 (1-5/8)	Ø41.30 (1-5/8)
Sound Pressure Level (Outdoor Unit)	Cooling	dB (A)	69.5	69.6
	Heating	dB (A)	70.6	70.6
Sound Power Level (Outdoor Unit)	Cooling	dB (A)	90.6	91.3
	Heating	dB (A)	93.4	93.8
Connecting Cable	Communication Cable (VCTF-SB)	mm ² x cores	0.75 - 1.5 x 2C	0.75 - 1.5 x 2C
Connectable Indoor Units Number	Max. (Conditional)	EA	64	64

1) Maximum numbers are prepared based on assumption that all 2.2kW indoor units are connected. The numbers in parentheses means maximum connectable indoor units in accordance with outdoor units combination (160% - 200%). The recommended ratio is 130%.

ARUM860LTE6 / ARUM880LTE6



HP			86	88
Classification	Chassis		UXC + UXC + UXB + UXB	UXC + UXC + UXB + UXB
	Combination Unit		ARUM240LTE6 ARUM240LTE6 ARUM200LTE6 ARUM180LTE6	ARUM240LTE6 ARUM240LTE6 ARUM200LTE6 ARUM200LTE6
Power Supply	V / Ø / Hz		380-415 / 3 / 50	380-415 / 3 / 50
Cooling Capacity	Rated	kW	240.8	246.4
	Heating Capacity			
Heating Capacity	Rated	kW	240.8	246.4
	Max	kW	270.9	277.2
Power Input (Cooling)	Rated	kW	84.23	87.38
Power Input (Heating)	Rated	kW	60.45	62.50
Efficiency	EER (Rated)	W/W	2.86	2.82
	COP (Rated)	W/W	3.98	3.94
	SEER	Wh/Wh	7.72	7.66
	SCOP	Wh/Wh	4.64	4.72
Outdoor Fan	Type		Propeller Fan	Propeller Fan
	Air Flow Rate (High)	m³/min x No.	(430 x 1) + (430 x 1) + (320 x 1) + (320 x 1)	(430 x 1) + (430 x 1) + (320 x 1) + (320 x 1)
	Discharge direction (Side / Top)		Top	Top
Outdoor Fan Motor	Drive		Direct	Direct
	Output	W x No.	(1,500 x 2) + (1,500 x 2) + (900 x 2) + (900 x 2)	(1,500 x 2) + (1,500 x 2) + (900 x 2) + (900 x 2)
Compressor	Type		Hermetically Sealed Scroll	Hermetically Sealed Scroll
	Piston Displacement	cm³/rev	62.1 x 8	62.1 x 8
	Number of Revolution	rev./min	3,600 x 8	3,600 x 8
	Motor Output	W x No.	5,300 x 8	5,300 x 8
	Oil Type		FW68L (PVE)	FW68L (PVE)
Heat Exchanger	Fin Type		Wide Louver Plus	Wide Louver Plus
Dimensions	Net (W x H x D)	mm	((1,640 x 1,745 x 760) x 2) + ((1,240 x 1,745 x 760) x 2)	((1,640 x 1,745 x 760) x 2) + ((1,240 x 1,745 x 760) x 2)
	Shipping (W x H x D)	mm	((1,675 x 1,919 x 802) x 2) + ((1,282 x 1,919 x 802) x 2)	((1,675 x 1,919 x 802) x 2) + ((1,282 x 1,919 x 802) x 2)
Weight	Net	kg	(362 x 1) + (362 x 1) + (300 x 1) + (300 x 1)	(362 x 1) + (362 x 1) + (300 x 1) + (300 x 1)
	Shipping	kg	(372 x 1) + (372 x 1) + (310 x 1) + (310 x 1)	(372 x 1) + (372 x 1) + (310 x 1) + (310 x 1)
Refrigerant	Type		R410A	R410A
	Precharged Amount	kg	64.0	64.0
	t-CO ₂ eq.		133.600	133.600
	Control Type		EEV	EEV
Connecting Pipe	Liquid	mm (inch)	Ø22.20 (7/8)	Ø22.20 (7/8)
	Gas	mm (inch)	Ø53.98 (2-1/8)	Ø53.98 (2-1/8)
	Low Pressure Gas (Heat Recovery)	mm (inch)	Ø53.98 (2-1/8)	Ø53.98 (2-1/8)
	High Pressure Gas (Heat Recovery)	mm (inch)	Ø41.30 (1-5/8)	Ø41.30 (1-5/8)
Sound Pressure Level (Outdoor Unit)	Cooling	dB (A)	69.6	69.8
	Heating	dB (A)	70.7	70.9
Sound Power Level (Outdoor Unit)	Cooling	dB (A)	91.3	91.5
	Heating	dB (A)	93.9	94.5
Connecting Cable	Communication Cable (VCTF-SB)	mm² x cores	0.75 - 1.5 x 2C	0.75 - 1.5 x 2C
Connectable Indoor Units Number	Max. (Conditional)	EA	64	64

1) Maximum numbers are prepared based on assumption that all 2.2kW indoor units are connected. The numbers in parentheses means maximum connectable indoor units in accordance with outdoor units combination (160% - 200%). The recommended ratio is 130%.

ARUM900LTE6 / ARUM920LTE6



HP			90	92
Classification	Chassis		UXC + UXC + UXC + UXB	UXC + UXC + UXC + UXC
	Combination Unit		ARUM240LTE6 ARUM240LTE6 ARUM220LTE6 ARUM200LTE6	ARUM240LTE6 ARUM240LTE6 ARUM220LTE6 ARUM220LTE6
Power Supply	V / Ø / Hz		380-415 / 3 / 50	380-415 / 3 / 50
Cooling Capacity	Rated	kW	252.0	257.6
	Heating Capacity	Rated	kW	252.0
Power Input (Cooling)	Max	kW	283.5	289.8
	Rated	kW	91.84	96.30
Power Input (Heating)	Rated	kW	65.82	69.14
	EER (Rated)	W/W	2.74	2.67
Efficiency	COP (Rated)	W/W	3.83	3.73
	SEER	Wh/Wh	7.36	7.06
	SCOP	Wh/Wh	4.59	4.47
	Type		Propeller Fan	Propeller Fan
Outdoor Fan	Air Flow Rate (High)	m ³ /min x No.	(430 x 1) + (430 x 1) + (430 x 1) + (320 x 1)	(430 x 1) + (430 x 1) + (430 x 1) + (430 x 1)
	Discharge direction (Side / Top)		Top	Top
Outdoor Fan Motor	Drive		Direct	Direct
	Output	W x No.	(1,500 x 2) + (1,500 x 2) + (1,500 x 2) + (900 x 2)	(1,500 x 2) + (1,500 x 2) + (1,500 x 2) + (1,500 x 2)
Compressor	Type		Hermetically Sealed Scroll	Hermetically Sealed Scroll
	Piston Displacement	cm ³ /rev	62.1 x 8	62.1 x 8
	Number of Revolution	rev./min	3,600 x 8	3,600 x 8
	Motor Output	W x No.	5,300 x 8	5,300 x 8
	Oil Type		FW68L (PVE)	FW68L (PVE)
Heat Exchanger	Fin Type		Wide Louver Plus	Wide Louver Plus
Dimensions	Net (W x H x D)	mm	((1,640 x 1,745 x 760) x 3) + ((1,240 x 1,745 x 760) x 1)	(1,640 x 1,745 x 760) x 4
	Shipping (W x H x D)	mm	((1,675 x 1,919 x 802) x 3) + ((1,282 x 1,919 x 802) x 1)	(1,675 x 1,919 x 802) x 4
Weight	Net	kg	(362 x 1) + (362 x 1) + (362 x 1) + (300 x 1)	(362 x 1) + (362 x 1) + (362 x 1) + (362 x 1)
	Shipping	kg	(372 x 1) + (372 x 1) + (372 x 1) + (310 x 1)	(372 x 1) + (372 x 1) + (372 x 1) + (372 x 1)
Refrigerant	Type		R410A	R410A
	Precharged Amount	kg	64.0	64.0
	t-CO ₂ eq.		133.600	133.600
	Control Type		EEV	EEV
Connecting Pipe	Liquid	mm (inch)	Ø22.20 (7/8)	Ø22.20 (7/8)
	Gas	mm (inch)	Ø53.98 (2-1/8)	Ø53.98 (2-1/8)
	Low Pressure Gas (Heat Recovery)	mm (inch)	Ø53.98 (2-1/8)	Ø53.98 (2-1/8)
	High Pressure Gas (Heat Recovery)	mm (inch)	Ø41.30 (1-5/8)	Ø41.30 (1-5/8)
Sound Pressure Level (Outdoor Unit)	Cooling	dB (A)	70.2	70.5
	Heating	dB (A)	71.5	72.0
Sound Power Level (Outdoor Unit)	Cooling	dB (A)	91.1	90.5
	Heating	dB (A)	94.3	94.0
Connecting Cable	Communication Cable (VCTF-SB)	mm ² x cores	0.75 - 1.5 x 2C	0.75 - 1.5 x 2C
Connectable Indoor Units Number	Max. (Conditional)	EA	64	64

1) Maximum numbers are prepared based on assumption that all 2.2kW indoor units are connected. The numbers in parentheses means maximum connectable indoor units in accordance with outdoor units combination (160% - 200%). The recommended ratio is 130%.

ARUM94LTE6 / ARUM96LTE6



HP			94	96
Classification	Chassis		UXC + UXC + UXC + UXC	UXC + UXC + UXC + UXC
	Combination Unit		ARUM240LTE6 ARUM240LTE6 ARUM240LTE6 ARUM220LTE6	ARUM240LTE6 ARUM240LTE6 ARUM240LTE6 ARUM240LTE6
Power Supply	V / Ø / Hz		380-415 / 3 / 50	380-415 / 3 / 50
Cooling Capacity	Rated	kW	263.2	268.8
	Heating Capacity			
Heating Capacity	Rated	kW	263.2	268.8
	Max	kW	296.1	302.4
Power Input (Cooling)	Rated	kW	100.50	104.60
Power Input (Heating)	Rated	kW	71.79	74.44
Efficiency	EER (Rated)	W/W	2.62	2.57
	COP (Rated)	W/W	3.67	3.61
	SEER	Wh/Wh	6.98	6.91
	SCOP	Wh/Wh	4.39	4.31
Outdoor Fan	Type		Propeller Fan	Propeller Fan
	Air Flow Rate (High)	m ³ /min x No.	(430 x 1) + (430 x 1) + (430 x 1) + (430 x 1)	(430 x 1) + (430 x 1) + (430 x 1) + (430 x 1)
	Discharge direction (Side / Top)		Top	Top
Outdoor Fan Motor	Drive		Direct	Direct
	Output	W x No.	(1,500 x 2) + (1,500 x 2) + (1,500 x 2) + (1,500 x 2)	(1,500 x 2) + (1,500 x 2) + (1,500 x 2) + (1,500 x 2)
Compressor	Type		Hermetically Sealed Scroll	Hermetically Sealed Scroll
	Piston Displacement	cm ³ /rev	62.1 x 8	62.1 x 8
	Number of Revolution	rev./min	3,600 x 8	3,600 x 8
	Motor Output	W x No.	5,300 x 8	5,300 x 8
	Oil Type		FW68L (PVE)	FW68L (PVE)
Heat Exchanger	Fin Type		Wide Louver Plus	Wide Louver Plus
Dimensions	Net (W x H x D)	mm	(1,640 x 1,745 x 760) x 4	(1,640 x 1,745 x 760) x 4
	Shipping (W x H x D)	mm	(1,675 x 1,919 x 802) x 4	(1,675 x 1,919 x 802) x 4
Weight	Net	kg	(362 x 1) + (362 x 1) + (362 x 1) + (362 x 1)	(362 x 1) + (362 x 1) + (362 x 1) + (362 x 1)
	Shipping	kg	(372 x 1) + (372 x 1) + (372 x 1) + (372 x 1)	(372 x 1) + (372 x 1) + (372 x 1) + (372 x 1)
Refrigerant	Type		R410A	R410A
	Precharged Amount	kg	64.0	64.0
	t-CO ₂ eq.		133.600	133.600
	Control Type		EEV	EEV
Connecting Pipe	Liquid	mm (inch)	Ø22.20 (7/8)	Ø22.20 (7/8)
	Gas	mm (inch)	Ø53.98 (2-1/8)	Ø53.98 (2-1/8)
	Low Pressure Gas (Heat Recovery)	mm (inch)	Ø53.98 (2-1/8)	Ø53.98 (2-1/8)
	High Pressure Gas (Heat Recovery)	mm (inch)	Ø41.30 (1-5/8)	Ø41.30 (1-5/8)
Sound Pressure Level (Outdoor Unit)	Cooling	dB (A)	70.8	71.0
	Heating	dB (A)	72.0	72.0
Sound Power Level (Outdoor Unit)	Cooling	dB (A)	90.8	91.0
	Heating	dB (A)	94.0	94.0
Connecting Cable	Communication Cable (VCTF-SB)	mm ² x cores	0.75 - 1.5 x 2C	0.75 - 1.5 x 2C
Connectable Indoor Units Number	Max. (Conditional)	EA	64	64

1) Maximum numbers are prepared based on assumption that all 2.2kW indoor units are connected. The numbers in parentheses means maximum connectable indoor units in accordance with outdoor units combination (160% - 200%). The recommended ratio is 130%.

1. Eurovent Test Condition : For more info regarding program consult www.eurovent-certification.com

2. Capacities are based on the following conditions :

- Cooling : Indoor 27°C (80.6°F) DB / 19°C (66.2°F) WB Outdoor 35°C (95°F) DB / 24°C (75.2°F) WB
- Heating : Indoor 20°C (68°F) DB / 15°C (59°F) WB Outdoor 7°C (44.6°F) DB / 6°C (42.8°F) WB
- Piping Length : Interconnected Pipe Length = 7.5m
- Elevation Difference (Outdoor ~ Indoor Unit) is 0m.

3. Wiring cable size must comply with the applicable local and national code.

4. Sound pressure level is measured on the rated condition in the anechoic rooms by ISO 3745 standard. Refer to the model specifications for nominal conditions. (Power source and Ambient temperature, etc) Sound levels can be increased in accordance with installation and operating conditions. (Operating conditions include some functional condition like Static Pressure mode, air guide use, Room target temperature setting, etc and these functions are different in accordance with each model.) Sound level will vary depending on a range of factors such as the construction(acoustic absorption coefficient) of particular room in which the equipment is installed.

5. Explanation of Terms

- EER : Energy Efficiency Ratio (Cooling)
- SEER : Seasonal Energy Efficiency Ratio (Refer to Typical Cooling Season)
- COP : Coefficient Of Performance (Heating)
- SCOP : Seasonal Coefficient Of Performance (Refer to Typical Heating Season)

6. Due to our policy of innovation some specifications may be changed without notification.

7. This product contains Fluorinated greenhouse gas. (R410A, GWP (Global warming potential) = 2,087.5)

MULTI V™ S

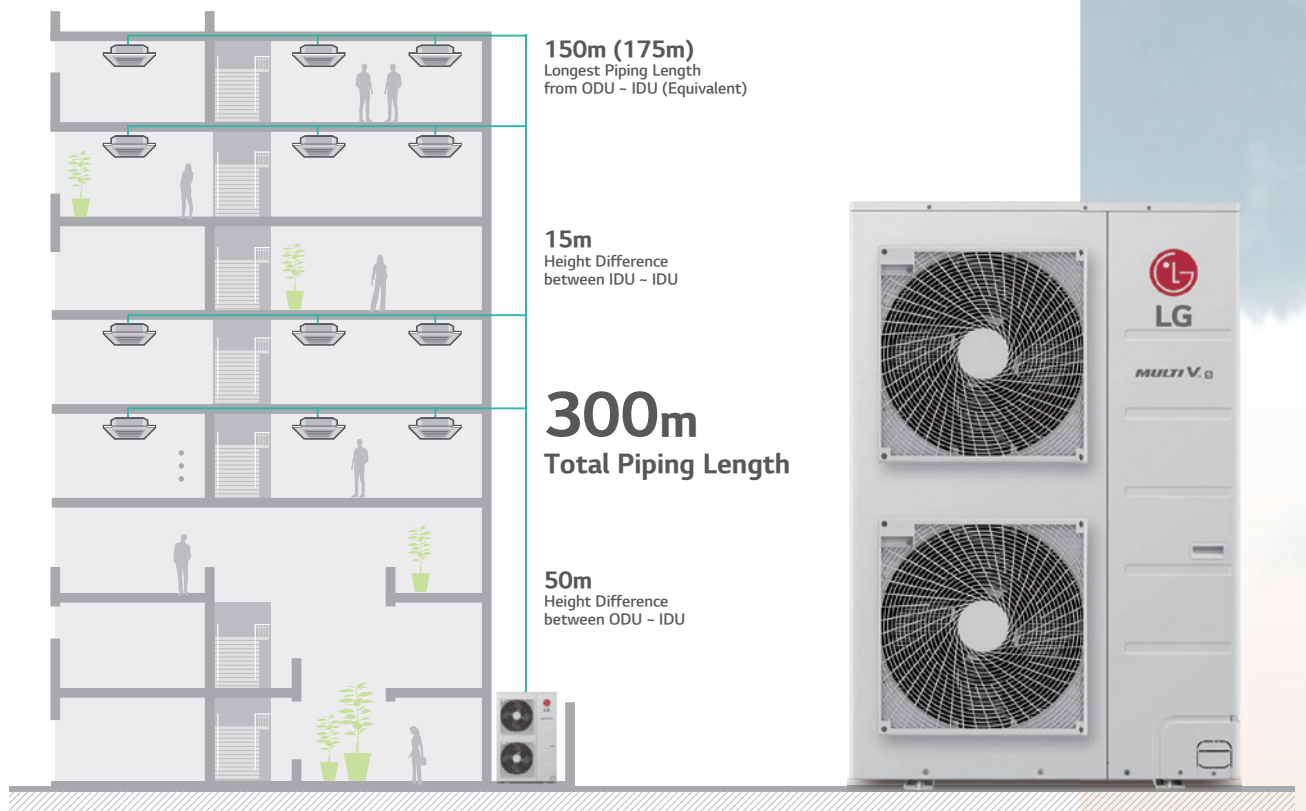

Highlight



Energy savings



Reliability



Convenience

- Air cooled VRF Heat pump & Heat Recovery
- 9.0 ~ 33.6kW (Cooling capacity based)
- Both 1Ø, 220 ~ 240V, 50Hz and 3Ø, 380 ~ 415V, 50Hz
- Side discharge outdoor unit
- Includes the industry's first single phase Heat Recovery system
- Includes the industry's first R32 side discharge

How does it work?

Available in Heat Pump and Heat Recovery Models

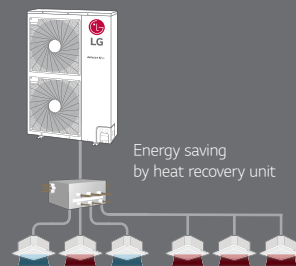

Combination of Cooling, Heating and Hot Water Solution

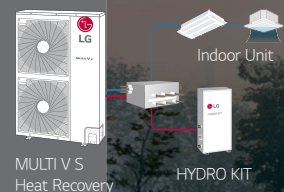

※ Heat Pump and Recovery are separated models.



OUTDOOR UNITS

MULTI V S

Smart Load Control Applied

Enhanced comfort and up to 23% energy savings with MULTI V load control

MULTI V S changes indoor discharge air temperature continuously according to load, to save energy.

※ Comparing to previous MULTI V model

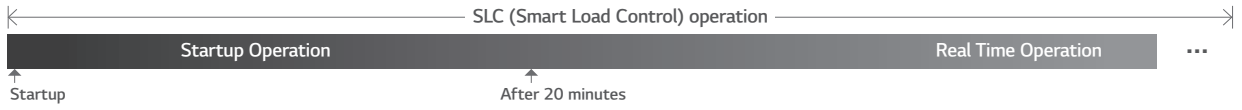

Startup Operation

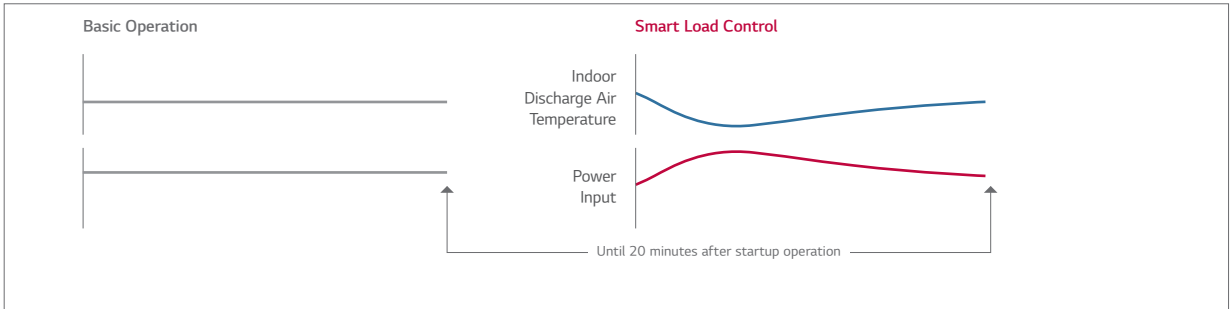

Max 10% Energy saving

- ※ Indoor air discharge temperature
- Energy efficiency increased by 3-step Smart Load Control during startup phase
- Discharge air temperature adjusted according to outdoor and indoor temperature
- Comfort level in cooling / heating operations ensured

Real Time Operation

Basic Operation

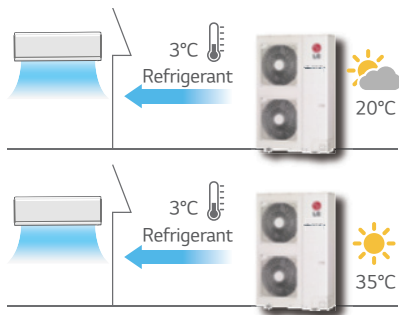

Fixed refrigerant temperature

Smart Load Control

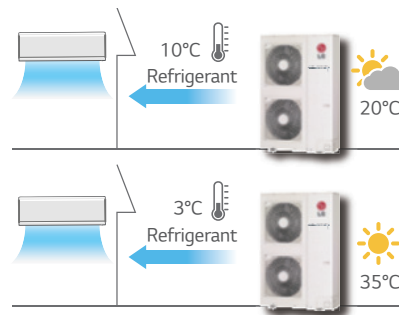

Fixed refrigerant temperature

Max 13% Energy saving

- ※ Comparing to previous MULTI V model
- ※ How to set up : By dip switch in outdoor unit (Referred to Product Data Book) Factory default setting is Off
- Outdoor temperature condition : EER 100% / 75% / 50% / 25% = 35°C (DB) / 30°C (DB) / 25°C (DB) / 20°C (DB)
- Indoor temperature condition : 27°C (DB) / 19°C (WB)
- ※ Dual sensing (Temperature & humidity) smart load control is possible with Remote controller PTEMTB100 (White) / PREMTBB10 (Black)

Inverter Twin Rotary & Inverter Scroll Compressor

Adapted high efficient compressor according to capacity

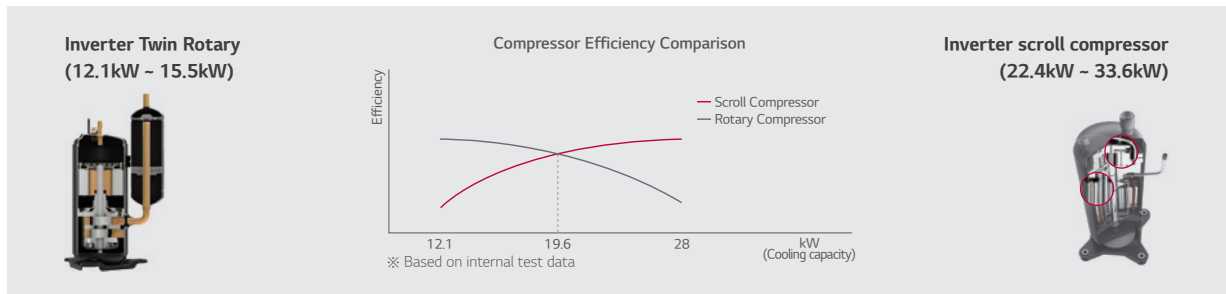

Inverter Twin Rotary

Concentrated Winding Motor

Oil path area is improved by over 50% by increasing the extra stator cavity. Due to this, caloric value of motor is reduced, improving the cooling function of stator coil.



Twin Rotary Rotor

Upper and lower part rotor offset imbalance in shaft rotor rotation. Vibration and noise is reduced. Max torque load decreased by 45% compared to single rotor.



Surface Coating

Surface coating of outstanding abrasion resistance property on vane and crank shaft.



Inverter scroll compressor

Best-in-class Compressor Speed

- Rapid response capability
- Compact core design (Concentrated motor)
- Down to 15Hz : Part load efficiency improvement

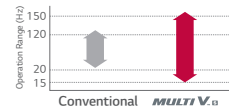

6 Bypass Valve

Compressor reliability is maximized with 6 Bypass Valve

- Prevent compressor damage due to excessively compressed refrigerant more efficiently than 4 Bypass valve



Direct Oil Injection

- Eliminate suction refrigerant gas heat loss through direct oil injection into compression chamber (Efficiency increases)
- Increased reliability with regulated oil supply

Scroll Profile

- The enhanced reliability with regulated oil supply
- Efficiency increases by expanding 96% Bypass area and 17% improved volume ratio by non-uniform scroll thickness

※ Comparing to previous MULTI V model

Optimal Heat Exchanger

Maximize efficiency according to different heat exchanger path by cooling and heating

Variable Heat Exchanger Circuit intelligently selects the optimal path. With this smart path selection technology, an average of 6% increase in the efficiency of both operations has been achieved.

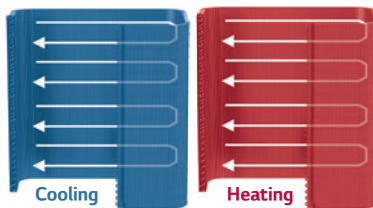
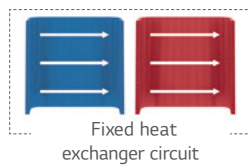

Efficiency performance

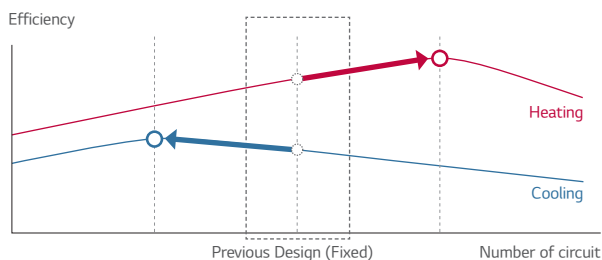

Efficiency up due to Fin shape

Improved heat exchanger efficiency of up to 28%

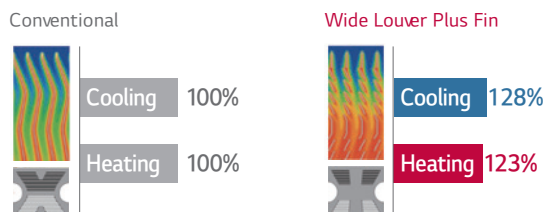

※ Comparing to previous MULTI V model

Reliable Refrigerant Components

LG technology allows for superior performance and component durability

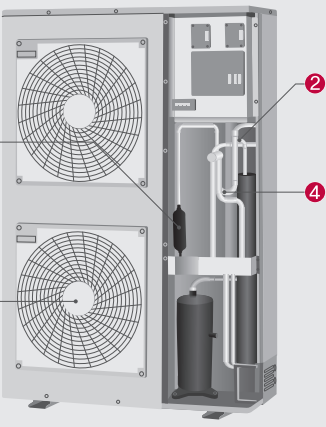

1 Cyclonic oil separator

- Highly reliable and efficient oil separation by centrifuge using cyclonic methods
- High collection efficiency as well as outstanding resistance to high temperature and pressure

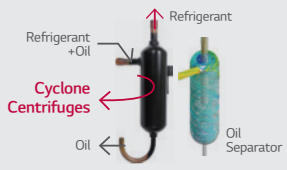

2 Large Volume Accumulator

- Improved reliability by adopting the large volume accumulator (38% volume up compared to conventional)
- Prevents the liquid refrigerant entering the compressor suction
- Maximize efficiency by optimal amount of refrigerant
- Protects compressor breakdown to increase product lifetime



3 BLDC Fan Motor

- The BLDC Fan motor is more efficient than a conventional AC motor, offering an additional 40% energy savings at low speeds and 20% at high speeds

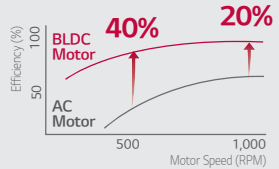

4 Double Sub-cool Interchanger

- Reliability is enhanced by minimizing pressure drop due to high efficiency spiral structure and 2 times larger size
- Long pipe is possible (up to* 1.75m) and high elevation (up to* 50m)
- Reduction of indoor refrigerant noise level



MULTI V S improved reliability with advanced technology :

- Oil separator
- Accumulator
- Sub-cooling

* Based on equivalent pipe length

※ BLDC motor vs. AC motor

Smart Control

Pressure control applied for smart, quick and precise response to user's temperature request

Temperature + Pressure Control

Senses and controls pressure directly using pressure sensor for faster and more precise response to load variation.

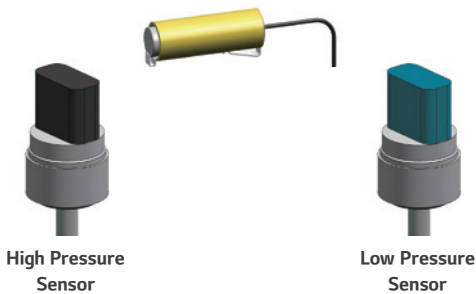

Quick Operating Response

Desired temperature can be reached up to 14% faster in cooling mode with pressure control, allowing more accurate control of indoor environment for maximized comfort.

※ Specifications may vary for each model

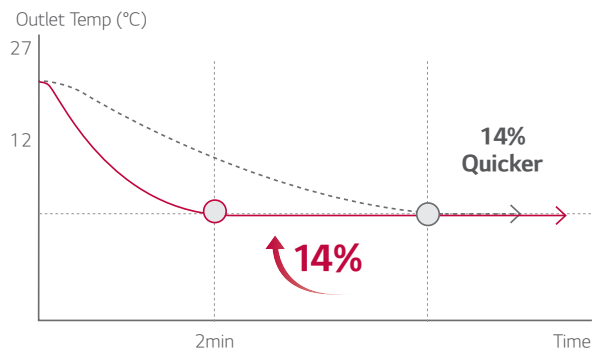

○ Pressure + Temperature Control
○ Temperature Control

※ Comparing to previous MULTI V model

Corrosion Resistance Black Fin

Strong durability against high salinity and heavily polluted air

Black Fin ensures continued operation of MULTI V S in highly corrosive environments such as salt laden atmosphere in coastal towns or severe air pollution in industrial cities. This improvement in durability prolongs the product's lifespan and lowers both the operational and maintenance costs.

Corrosion Resistance Proven by Certified Tests

LG Corrosion Resistance solution passed ISO 21207 accelerated corrosion test conducted by an independent test organization and the result has been certified by prestigious global certification organization, TUV.

Certified protection



※ Verification of corrosion resistance performance
 - Test Method B of ISO 21207
 - ASTM B117 / ISO 9227 (10,000 hours)

Enhanced Coating Layers

The black coating with enhanced epoxy resin is applied for strong protection from various corrosive external conditions such as salt contamination and air pollution. Moreover, the hydrophilic film keeps water from accumulating on the heat exchanger's fin, minimizing moisture buildup and eventually making it even more corrosion resistant.

Hydrophilic Coating (Water flow)

The Hydrophilic coating minimizes moisture buildup on the fin.

Complex Resin (Corrosion resistant)

The Black coating provides strong protection from corrosion.

Aluminum fin

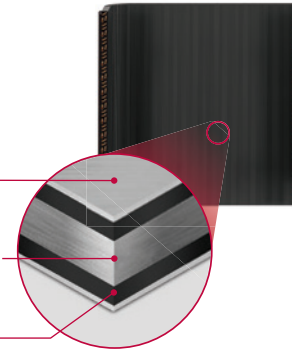

Sufficient Piping Length

Increased piping length allows for flexible design and installation

MULTI V S inverter technology and sub cooling control circuit technology allows greater piping length and outstanding elevation differences. A cooling system can be implemented more flexibly in a shop, office and even high-rise building, reducing the designer's work time and providing more efficient design.

Piping Capabilities

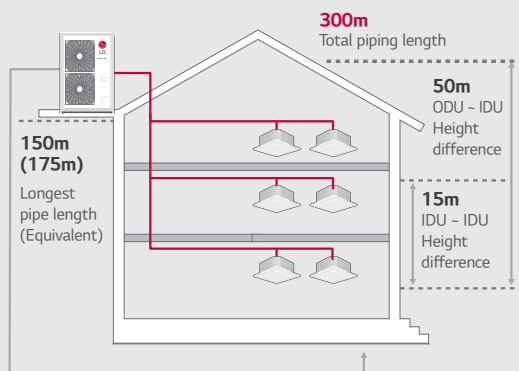

4 Way Piping

- Free design and installation by 4 way piping.

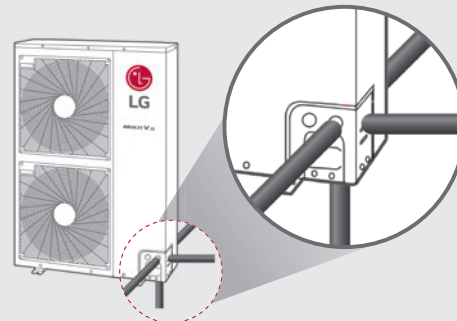

Low Noise Operation

Decreased noise during operation with low noise functionality

At night low noise mode, the noise level can reduce up to 14% in comparison with normal operation mode.

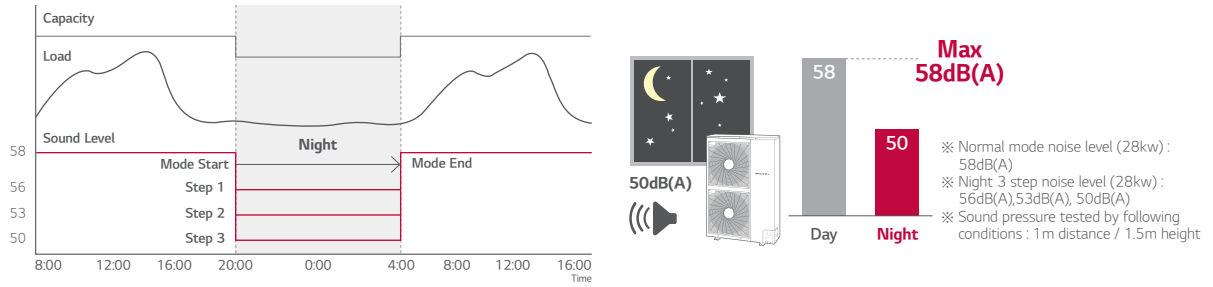

Fan Technology and RPM Control

External static pressure control enables outdoor unit to offer more flexibility in installations.

New axial fan offers higher air volume, increased static pressure, decreased noise and enhanced efficiency.

Fan Technology

The new axial fan has a mogul trailing edge, narrow hub blade and reverse hub, this provides a high efficiency, low noise, wide fan, as well as improving the air flow rate.

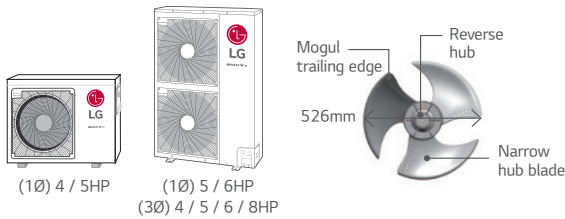

Super cannon fan increases the air volume in 50 CMM and the noise level is decreased by 4dB(A).

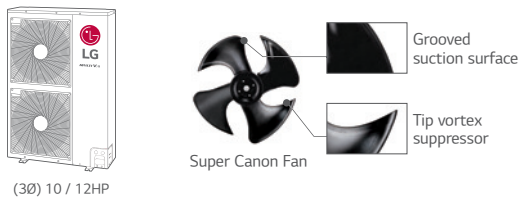

Fan RPM control

Due to the new shroud and ROM control, the air flows straight away from the fan even in high-rise buildings.

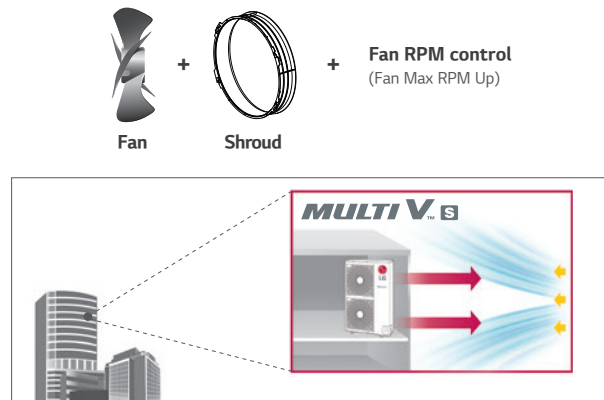

- Straight air flow
- New shroud adopted
- Performs high static pressure

Upgraded Fault Detection and Diagnosis

Easy and convenient maintenance with self-diagnosis

The inclusion of FDD elements - Auto start-up, auto refrigerant check, black box functionality, simultaneous evaluation, and auto refrigerant collection, provides the optimal solution for user reliability and ease of maintenance.

- Auto commissioning mode
- Auto refrigerant collection
- Auto evaluation of refrigerant amount and charging
- Able to access LGMV (LG Monitoring View) by smartphone
- Black box function
- Piping & wiring error check-up
- FDD (Fault Detection and Diagnosis)

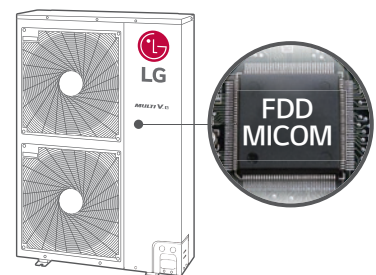

Nomenclature

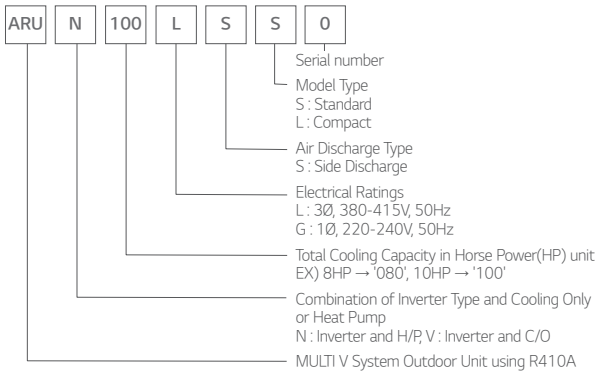

Outdoor Units Function

Category	Functions	MULTI V S	
Key Refrigerant Components	Variable Path of Outdoor Unit HEX	-	
	HiPOR™ (High Pressure Oil Return)	-	
	Humidity Sensor	ARUB060GSS4 only	
	Corrosion Resistance Black Fin	○	
	Oil Sensor	-	
Special Function	Dual Sensing	ARUB060GSS4 only	
	Low Noise Operation	○	
	High Static Mode of Outdoor Unit Fan	○	
	Partial Defrosting	-	
	Auto Dust Removal of Outdoor Unit (Fan reverse rotation)	-	
	Indoor Cooling Comfort Mode Based Outdoor Temperature	○	
	Smart Load Control (SLC) (Changing indoor discharge air temperature according to load)	○	
	Outdoor Unit Control Refer to Humidity	ARUB060GSS4 only	
	Defrost / Deicing	○	
	High Pressure Switch	○	
Basic Function	Phase Protection	○	
	Restart Delay (3-minutes)	○	
	Self Diagnosis	○	
	Soft Start	○	
Central Controller	Test Run Function	-	
	AC Ez (Simple Controller)	PQCSZ250S0	
	AC Ez Touch	PACEZA000	
	AC Smart IV	PACS4B000	
	AC Smart 5	PACS5A000	
	ACP (Advanced Control Platform) IV	PACP4B000	
	ACP (Advanced Control Platform) 5	PACP5A000	
	AC Manager 5	PACM5A000	
	BNU (Building Network Unit)	ACPS (w U60FT)	○
		ACP BACnet	PQNFB17C0
IO Module (ODU Dry Contact)		PVDSMN000	
PDI (Power Distribution Indicator)	Standard	PPWRDB000	
	Premium	PQNUD1S40	
Cool / Heat Selector		PRDSBM	
Cycle Monitoring Device	LGMV	PRCTILO	
	Mobile LGMV	PLGMVV100	
Additional kit	Refrigerant Charging Kit	○ (Logical operation) Not applied to ARUB060GSS4	
	Low Ambient Kit	-	
	Variable Water Flow Valve Control Kit	-	

※ ○ : Applied, - : Not Applied

ARUN040GSS0

[Unit : mm]

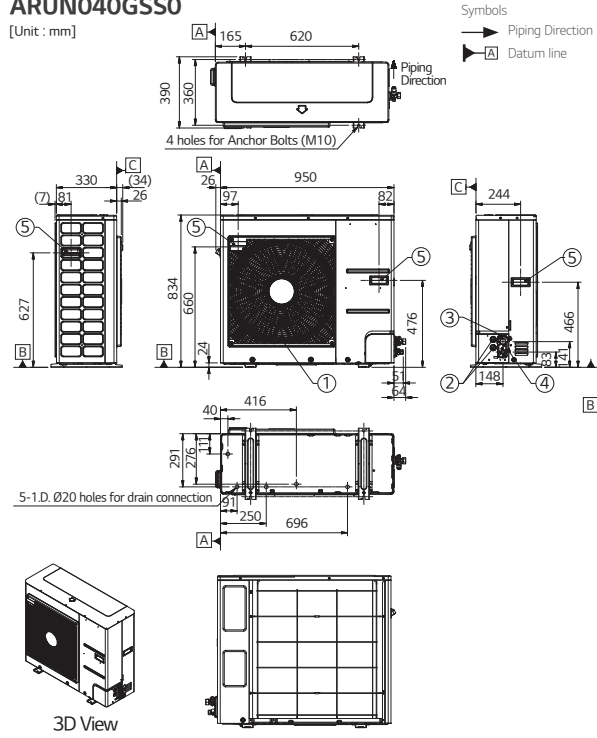

ARUN080LSS0

[Unit : mm]

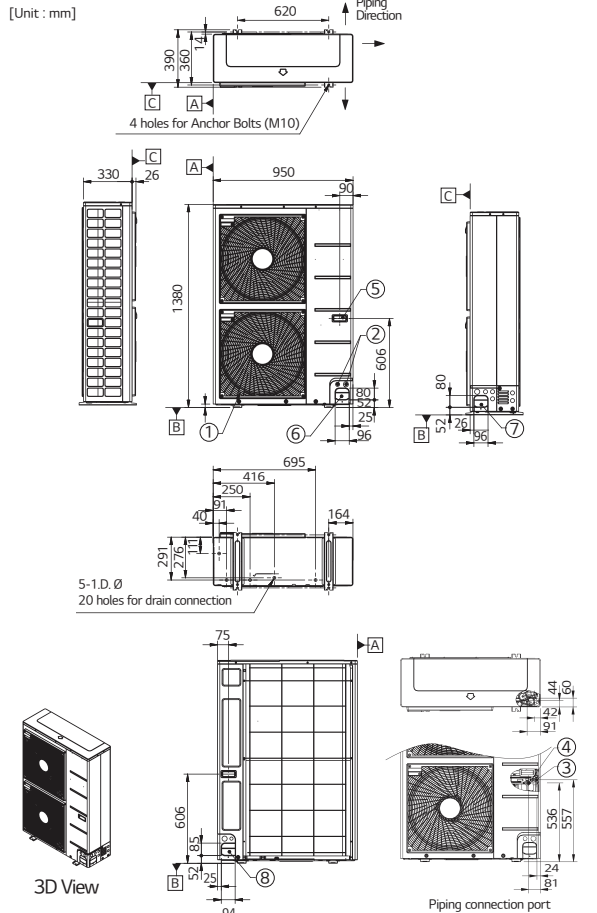

- Note
- Unit should be installed in compliance with the installation manual in the product box.
 - Unit should be grounded in accordance with the local regulation or applicable national codes.
 - All electrical components and materials to be supplied from the site must comply with the local regulations or international codes.
 - Electrical characteristics chapter should be considered for electrical work and design. Especially the power cable and circuit breaker should be selected in accordance with that.

No.	Part Name	Description
1	Air Outlet	-
2	Power and communication cable Hole	-
3	Gas Pipe Connection	Welding joint
4	Liquid Pipe Connection	Welding joint
5	Handle	-
6	Pipe routing hole (front)	-
7	Pipe routing hole (side)	-
8	Pipe routing hole (back)	-

Heat Pump

Cooling

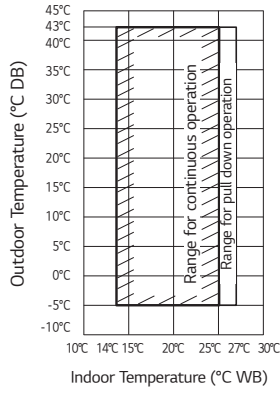

Heating

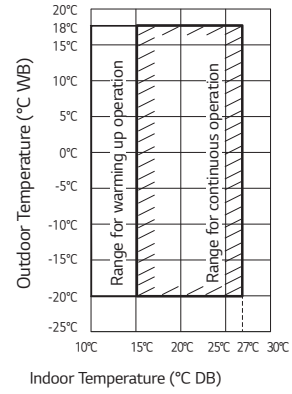

Heat Recovery

Cooling

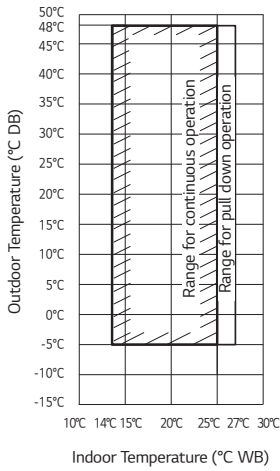

Heating

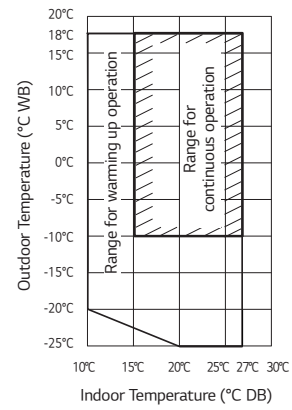

Simultaneous Cooling

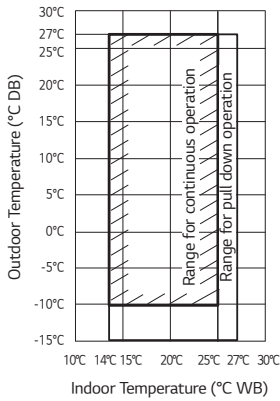

Simultaneous Heating

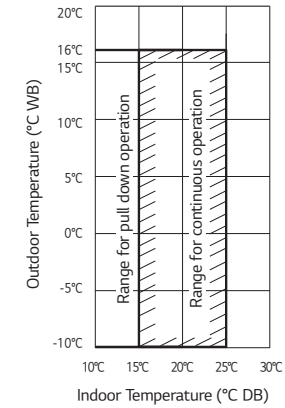

Note

1. These figures assume the following operating conditions : Equivalent piping length : 7.5m
Level difference : 0m
2. Range of pull down operation : If the relative humidity is too high, cooling capacity can be decreased by the sensible

Position of Sound Level Measuring

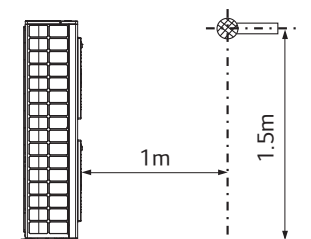

Note

1. These figures assume the following operating conditions :
Equivalent piping length : 7.5m
Level difference : 0m

ARUN040GSS0



LG participates in the ECP programme for EUROVENT VRF program. Check ongoing validity of certification : www.eurovent-certification.com

HP			4	
Model Name			ARUN040GSS0	
Capacity	Cooling (Rated)	kW	12.1	
	Heating (Rated)	kW	12.5	
Input	Cooling (Rated)	kW	4.03	
	Heating (Rated)	kW	3.10	
EER			3.00	
SEER			5.63	
COP Rated Capacity			4.03	
SCOP			3.97	
Exterior	Color (General)		Warm Gray	
	RAL Code (Classic)		RAL 7044	
Heat Exchanger	Type		Wide Louver Plus	
	Type		BLDC Inverter Twin Rotary	
Compressor	Combination x No.		(Inverter) x 1	
	Motor Output x Number	W x No.	4,000 x 1	
	Oil Type		FW68D (PVE)	
	Oil Charge		cc	1,300
Fan	Type		Axial Flow Fan	
	Motor Output x Number	W x No.	124 x 1	
	Air Flow Rate (High)		m ³ /min x No.	60
	Drive		DC INVERTER	
	Discharge		Side / Top	Side
Pipe Connection	Liquid Pipe	mm (inch)	Ø9.52 (3/8)	
	Gas Pipe	mm (inch)	Ø15.88 (5/8)	
Dimensions (W x H x D)			mm x No.	950 x 834 x 330
Dimensions (W x H x D) - Shipping			mm x No.	(1,065 x 918 x 461) x 1
Net Weight			kg x No.	70
Shipping Weight			kg x No.	77 x 1
Sound Pressure Level	Cooling		dB(A)	50
	Heating		dB(A)	52
Sound Power Level	Cooling		dB(A)	72
	Heating		dB(A)	75
Communication Cable			mm ² x No. (VCTF-SB)	2C x 1.0 - 1.5
Refrigerant	Refrigerant Name		R410A	
	Precharged Amount in factory		kg	1.8
	t-CO ₂ eq			3.758
	Control		Electronic Expansion Valve	
Power Supply			Ø, V, Hz	220-240, 1, 50 220, 1, 60
Number of Maximum Connectable Indoor Units				8

Note

- Eurovent Test Condition : Type of indoor unit connected is only Ceiling Concealed Duct.
 - Refer to EUROVENT certification regulation for more detail test conditions.
 - Refer to EUROVENT website for test values connected Ceiling Cassette type indoors.
- Performances are based on the following conditions :
 - Cooling Temperature : Indoor 27°C (80.6°F) DB / 19°C (66.2°F) WB / Outdoor 35°C (95°F) DB / 24°C (75.2°F) WB
 - Heating Temperature : Indoor 20°C (68°F) DB / 15°C (59°F) WB / Outdoor 7°C (44.6°F) DB / 6°C (42.8°F) WB
- The maximum combination ratio is 160%.
- Wiring cable size must comply with the applicable local and national codes.
- Due to our policy of innovation some specifications may be changed without notification.
- Sound pressure level is measured on the rated condition in the anechoic rooms by ISO 3745 standard.
 - Sound power level is measured on the rated condition in the semi-anechoic rooms by ISO 9614 standard.
 Therefore, these values can be increased owing to ambient conditions during operation.
- Power factor could vary less than ±1% according to the operating conditions.
- This product contains Fluorinated greenhouse gases. (R410A, GWP(Global warming potential) = 2087.5)

ARUN050GSS0 / ARUN060GSS0



LG participates in the ECP programme for EUROVENT VRF program. Check ongoing validity of certification : www.eurovent-certification.com

HP			5	6
Model Name			ARUN050GSS0	ARUN060GSS0
Capacity	Cooling (Rated)	kW	14.0	15.5
	Heating (Rated)	kW	16.0	18.0
Input	Cooling (Rated)	kW	4.59	5.17
	Heating (Rated)	kW	4.18	5.00
EER			3.05	3.00
SEER			7.40	7.53
COP Rated Capacity			3.83	3.60
SCOP			4.16	4.35
Exterior	Color (General)		Warm Gray	Warm Gray
	RAL Code (Classic)		RAL 7044	RAL 7044
Heat Exchanger	Type		Wide Louver Plus	Wide Louver Plus
	Type		BLDC Inverter Twin Rotary	BLDC Inverter Twin Rotary
Compressor	Combination x No.		(Inverter) x 1	(Inverter) x 1
	Motor Output x Number	W x No.	4,000 x 1	4,000 x 1
	Oil Type		FW68D (PVE)	FW68D (PVE)
	Oil Charge	cc	1,300	1,300
Fan	Type		Axial Flow Fan	Axial Flow Fan
	Motor Output x Number	W x No.	124 x 2	124 x 2
	Air Flow Rate (High)	m ³ /min x No.	110	110
	Drive		DC INVERTER	DC INVERTER
	Discharge	Side / Top	Side	Side
Pipe Connection	Liquid Pipe	mm (inch)	Ø9.52 (3/8)	Ø9.52 (3/8)
	Gas Pipe	mm (inch)	Ø15.88 (5/8)	Ø19.05 (3/4)
Dimensions (W x H x D)			950 x 1,380 x 330	950 x 1,380 x 330
Dimensions (W x H x D) - Shipping			(1,065 x 918 x 461) x 1	(1,065 x 918 x 461) x 1
Net Weight			94	94
Shipping Weight			106	106
Sound Pressure Level	Cooling	dB(A)	51	52
	Heating	dB(A)	53	54
Sound Power Level	Cooling	dB(A)	72	72
	Heating	dB(A)	76	77
Communication Cable			2C x 1.0 - 1.5	2C x 1.0 - 1.5
Refrigerant	Refrigerant Name		R410A	R410A
	Precharged Amount in factory	kg	3.0	3.0
	t-CO ₂ eq		6.263	6.263
	Control		Electronic Expansion Valve	Electronic Expansion Valve
Power Supply	Ø, V, Hz		220-240, 1, 50	220-240, 1, 50
			220, 1, 60	220, 1, 60
Number of Maximum Connectable Indoor Units			10	13

Note

- Eurovent Test Condition : Type of indoor unit connected is only Ceiling Concealed Duct.
 - Refer to EUROVENT certification regulation for more detail test conditions.
 - Refer to EUROVENT website for test values connected Ceiling Cassette type indoors.
- Performances are based on the following conditions:
 - Cooling Temperature : Indoor 27°C (80.6°F) DB / 19°C (66.2°F) WB / Outdoor 35°C (95°F) DB / 24°C (75.2°F) WB
 - Heating Temperature : Indoor 20°C (68°F) DB / 15°C (59°F) WB / Outdoor 7°C (44.6°F) DB / 6°C (42.8°F) WB
- The maximum combination ratio is 160%.
- Wiring cable size must comply with the applicable local and national codes.
- Due to our policy of innovation some specifications may be changed without notification.
- Sound pressure level is measured on the rated condition in the anechoic rooms by ISO 3745 standard. Sound power level is measured on the rated condition in the semi-anechoic rooms by ISO 9614 standard. Therefore, these values can be increased owing to ambient conditions during operation.
- Power factor could vary less than ±1% according to the operating conditions.
- This product contains Fluorinated greenhouse gases. (R410A, GWP(Global warming potential) = 2087.5)

ARUN040LSS0 / ARUN050LSS0 ARUN060LSS0



LG participates in the ECP programme for EUROVENT VRF program. Check ongoing validity of certification : www.eurovent-certification.com

HP			4	5	6
Model Name			ARUN040LSS0	ARUN050LSS0	ARUN060LSS0
Capacity	Cooling (Rated)	kW	12.1	14.0	15.5
	Heating (Rated)	kW	12.5	16.0	18.0
Input	Cooling (Rated)	kW	3.39	4.59	5.17
	Heating (Rated)	kW	2.75	4.18	5.00
EER			3.57	3.05	3.00
SEER			7.42	7.40	7.53
COP Rated Capacity			4.55	3.83	3.60
SCOP			4.30	4.16	4.35
Exterior	Color (General)		Warm Gray	Warm Gray	Warm Gray
	RAL Code (Classic)		RAL 7044	RAL 7044	RAL 7044
Heat Exchanger	Type		Wide Louver Plus	Wide Louver Plus	Wide Louver Plus
	Type		BLDC Inverter Twin Rotary	BLDC Inverter Twin Rotary	BLDC Inverter Twin Rotary
Compressor	Combination x No.		(Inverter) x 1	(Inverter) x 1	(Inverter) x 1
	Motor Output x Number	W x No.	4,000 x 1	4,000 x 1	4,000 x 1
	Oil Type		FW68D (PVE)	FW68D (PVE)	FW68D (PVE)
	Oil Charge	cc	1,300	1,300	1,300
	Type		Axial Flow Fan	Axial Flow Fan	Axial Flow Fan
Fan	Motor Output x Number	W x No.	124 x 2	124 x 2	124 x 2
	Air Flow Rate (High)	m ³ /min x No.	110	110	110
	Drive		DC INVERTER	DC INVERTER	DC INVERTER
	Discharge	Side / Top	Side	Side	Side
Pipe Connection	Liquid Pipe	mm (inch)	Ø9.52 (3/8)	Ø9.52 (3/8)	Ø9.52 (3/8)
	Gas Pipe	mm (inch)	Ø15.883(5/8)	Ø15.88 (5/8)	Ø19.05 (3/4)
Dimensions (W x H x D)			950 x 1,380 x 330	950 x 1,380 x 330	950 x 1,380 x 330
Dimensions (W x H x D) - Shipping			(1,065 x 918 x 461) x 1	(1,065 x 918 x 461) x 1	(1,065 x 918 x 461) x 1
Net Weight			96	96	96
Shipping Weight			108	108	108
Sound Pressure Level	Cooling	dB(A)	50	51	52
	Heating	dB(A)	52	53	54
Sound Power Level	Cooling	dB(A)	72	72	72
	Heating	dB(A)	76	76	77
Communication Cable			mm ² x No. (VCTF-SB) 2C x 1.0 - 1.5	2C x 1.0 - 1.5	2C x 1.0 - 1.5
Refrigerant	Refrigerant Name		R410A	R410A	R410A
	Precharged Amount in factory	kg	3.0	3.0	3.0
	t-CO ₂ eq		6.263	6.263	6.263
	Control		Electronic Expansion Valve	Electronic Expansion Valve	Electronic Expansion Valve
Power Supply			Ø, V, Hz 380-415, 3, 50 380, 3, 60	380-415, 3, 50 380, 3, 60	380-415, 3, 50 380, 3, 60
Number of Maximum Connectable Indoor Units			8	10	13

Note

- Eurovent Test Condition : Type of indoor unit connected is only Ceiling Concealed Duct.
 - Refer to EUROVENT certification regulation for more detail test conditions.
 - Refer to EUROVENT website for test values connected Ceiling Cassette type indoors.
- Performances are based on the following conditions :
 - Cooling Temperature : Indoor 27°C (80.6°F) DB / 19°C (66.2°F) WB / Outdoor 35°C (95°F) DB / 24°C (75.2°F) WB
 - Heating Temperature : Indoor 20°C (68°F) DB / 15°C (59°F) WB / Outdoor 7°C (44.6°F) DB / 6°C (42.8°F) WB
- The maximum combination ratio is 160%.
- Wiring cable size must comply with the applicable local and national codes.
- Due to our policy of innovation some specifications may be changed without notification.
- Sound pressure level is measured on the rated condition in the anechoic rooms by ISO 3745 standard. Sound power level is measured on the rated condition in the semi-anechoic rooms by ISO 9614 standard. Therefore, these values can be increased owing to ambient conditions during operation.
- Power factor could vary less than ±1% according to the operating conditions.
- This product contains Fluorinated greenhouse gases. (R410A, GWP(Global warming potential) = 2087.5)

**ARUN080LSS0 / ARUN100LSS0
ARUN120LSS0**



LG participates in the ECP programme for EUROVENT VRF program. Check ongoing validity of certification : www.eurovent-certification.com

HP			8	10	12
Model Name			ARUN080LSS0	ARUN100LSS0	ARUN120LSS0
Capacity	Cooling (Rated)	kW	22.4	28.0	33.6
	Heating (Rated)	kW	24.5	30.6	36.7
Input	Cooling (Rated)	kW	8.45	12.44	15.27
	Heating (Rated)	kW	6.96	8.50	12.23
EER			2.65	2.25	2.20
SEER			7.13	6.28	6.50
COP Rated Capacity			3.52	3.60	3.00
SCOP			4.53	4.21	4.32
Exterior	Color (General)		Warm Gray	Warm Gray	Warm Gray
	RAL Code (Classic)		RAL 7044	RAL 7044	RAL 7044
Heat Exchanger	Type		Wide Louver Plus	Wide Louver Plus	Wide Louver Plus
	Type		Hermetically Sealed Scroll	Hermetically Sealed Scroll	Hermetically Sealed Scroll
Compressor	Combination x No.		(Inverter) x 1	(Inverter) x 1	(Inverter) x 1
	Motor Output x Number	W x No.	4,200 x 1	5,300 x 1	5,300 x 1
	Oil Type		FW68D (PVE)	FW68D (PVE)	FW68D (PVE)
	Oil Charge	cc	2,400	2,600	3,400
Fan	Type		Propeller fan	Propeller fan	Propeller fan
	Motor Output x Number	W x No.	124 x 2	250 x 2	250 x 2
	Air Flow Rate (High)	m ³ /min x No.	140	190	190
	Drive		DC INVERTER	DC INVERTER	DC INVERTER
	Discharge	Side / Top	Side	Side	Side
Pipe Connection	Liquid Pipe	mm (inch)	Ø9.52 (3/8)	Ø9.52 (3/8)	Ø12.7 (1/2)
	Gas Pipe	mm (inch)	Ø19.05 (3/4)	Ø22.2 (7/8)	Ø28.58 (1-1/8)
Dimensions (W x H x D)			950 x 1,380 x 330	1,090 x 1,625 x 380	1,090 x 1,625 x 380
Dimensions (W x H x D) - Shipping			(1,065 x 918 x 461) x 1	(1,065 x 918 x 461) x 1	(1,065 x 918 x 461) x 1
Net Weight			115	142	155
Shipping Weight			127	158	171
Sound Pressure Level	Cooling	dB(A)	57	58	60
	Heating	dB(A)	57	58	60
Sound Power Level	Cooling	dB(A)	78	77	78
	Heating	dB(A)	81	79	82
Communication Cable			2C x 1.0 - 1.5	2C x 1.0 - 1.5	2C x 1.0 - 1.5
Refrigerant	Refrigerant Name		R410A	R410A	R410A
	Precharged Amount in factory	kg	3.5	4.5	6.0
	t-CO ₂ eq		7.306	9.394	12.525
	Control		Electronic Expansion Valve	Electronic Expansion Valve	Electronic Expansion Valve
Power Supply	Ø, V, Hz		380-415, 3, 50	380-415, 3, 50	380-415, 3, 50
			380, 3, 60	380, 3, 60	380, 3, 60
Number of Maximum Connectable Indoor Units			13	16	20

Note

- Eurovent Test Condition : Type of indoor unit connected is only Ceiling Concealed Duct.
 - Refer to EUROVENT certification regulation for more detail test conditions.
 - Refer to EUROVENT website for test values connected Ceiling Cassette type indoors.
- Performances are based on the following conditions :
 - Cooling Temperature : Indoor 27°C (80.6°F) DB / 19°C (66.2°F) WB / Outdoor 35°C (95°F) DB / 24°C (75.2°F) WB
 - Heating Temperature : Indoor 20°C (68°F) DB / 15°C (59°F) WB / Outdoor 7°C (44.6°F) DB / 6°C (42.8°F) WB
- The maximum combination ratio is 160%.
- Wiring cable size must comply with the applicable local and national codes.
- Due to our policy of innovation some specifications may be changed without notification.
- Sound pressure level is measured on the rated condition in the anechoic rooms by ISO 3745 standard. Sound power level is measured on the rated condition in the semi-anechoic rooms by ISO 9614 standard. Therefore, these values can be increased owing to ambient conditions during operation.
- Power factor could vary less than ±1% according to the operating conditions.
- This product contains Fluorinated greenhouse gases. (R410A, GWP(Global warming potential) = 2087.5)

ARUB060GSS4



LG participates in the ECP programme for EUROVENT VRF program. Check ongoing validity of certification : www.eurovent-certification.com

HP			6	
Model Name			ARUB060GSS4	
Capacity	Cooling (Rated)	kW	15.5	
	Heating (Rated)	kW	18.0	
Input	Cooling (Rated)	kW	5.74	
	Heating (Rated)	kW	5.14	
EER			2.70	
SEER			5.92	
COP Rated Capacity			3.50	
SCOP			3.79	
Exterior	Color		Warm Gray	
	RAL Code (Classic)		RAL 7044	
Heat Exchanger	Type		Wide Louver Plus	
	Type		Hermetically Sealed Scroll	
Compressor	Combination x No.		(Inverter) x 1	
	Motor Output x Number	W x No.	4,200 x 1	
	Oil Type		FW68D (PVE)	
	Oil Charge	cc	1,700	
Fan	Type		Axial Flow Fan	
	Motor Output x Number	W x No.	124 x 2	
	Air Flow Rate (High)		m ³ /min x No.	110
	Drive		DC INVERTER	
	Discharge	Side / Top	Side	
Pipe Connection #1	Liquid Pipe	mm (inch)	Ø9.52 (3/8)	
	Low Pressure Gas Pipe	mm (inch)	Ø19.05 (3/4)	
	High Pressure Gas Pipe	mm (inch)	Ø15.88 (5/8)	
Dimensions (W x H x D)			950 x 1,380 x 330	
Dimensions (W x H x D) - shipping			(1,140 x 1,549 x 466) x 1	
Net Weight			118	
Shipping Weight			132	
Sound Pressure Level	Cooling	dB(A)	56	
	Heating	dB(A)	58	
Sound Power Level	Cooling	dB(A)	76	
	Heating	dB(A)	78	
Communication Cable			mm ² x No. (VCTF-SB)	2C x 1.0 - 1.5
Refrigerant	Refrigerant Name		R410A	
	Precharged Amount in factory	kg	3.5	
	t-CO ₂ eq		7.306	
	Control		Electronic Expansion Valve	
Power Supply			Ø, V, Hz	220-230-240, 1, 50/60
Number of Maximum Connectable Indoor Units			13	

Note

- Eurovent Test Condition : Type of indoor unit connected is only Ceiling Concealed Duct.
 - Refer to EUROVENT certification regulation for more detail test conditions.
 - Refer to EUROVENT website for test values connected Ceiling Cassette type indoors.
- Performances are based on the following conditions :
 - Cooling Temperature : Indoor 27°C (80.6°F) DB / 19°C (66.2°F) WB / Outdoor 35°C (95°F) DB / 24°C (75.2°F) WB
 - Heating Temperature : Indoor 20°C (68°F) DB / 15°C (59°F) WB / Outdoor 7°C (44.6°F) DB / 6°C (42.8°F) WB
- The maximum combination ratio is 160%.
- Wiring cable size must comply with the applicable local and national codes.
- Due to our policy of innovation some specifications may be changed without notification.
- Sound pressure level is measured on the rated condition in the anechoic rooms by ISO 3745 standard. Sound power level is measured on the rated condition in the semi-anechoic rooms by ISO 9614 standard. Therefore, these values can be increased owing to ambient conditions during operation.
- Power factor could vary less than ±1% according to the operating conditions.
- This product contains Fluorinated greenhouse gases. (R410A, GWP(Global warming potential) = 2087.5)

Energy Savings

Energy consumption can be reduced as indoor heat is absorbed and transferred to hot water supply.

MULTI V S Heat Recovery with HYDRO KIT

Absorbed heat from indoor space is used for making hot water.

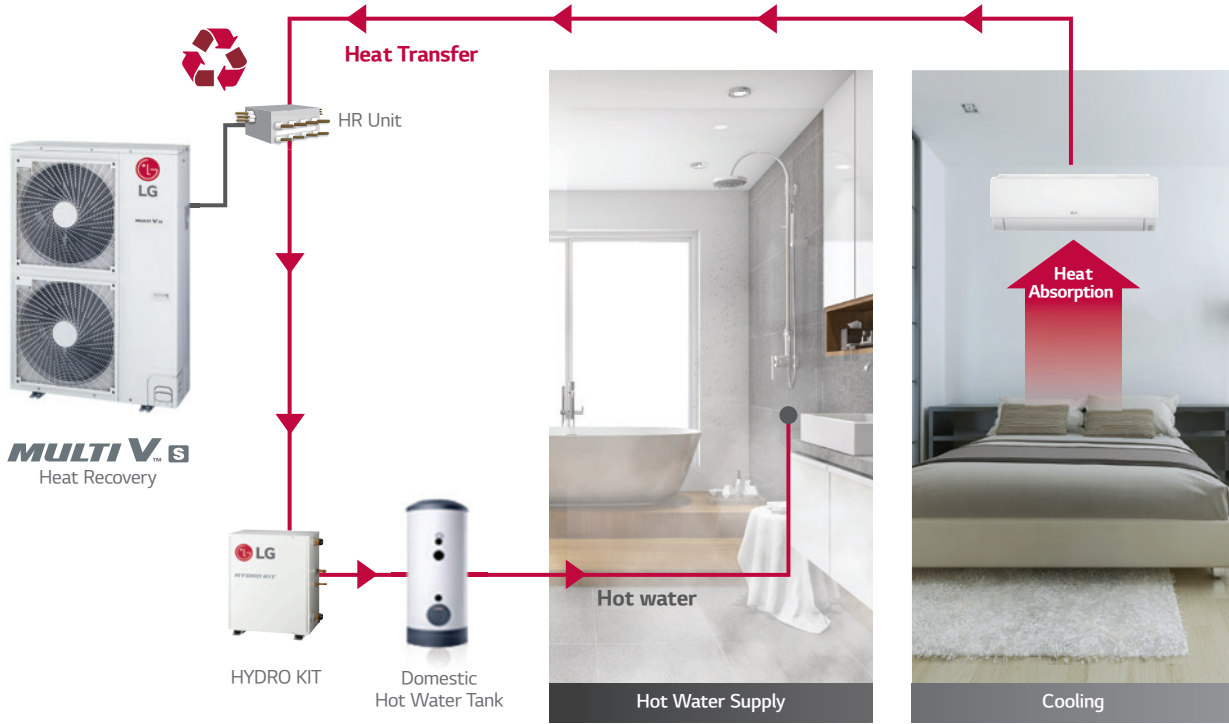

MULTI VTM S



- Air cooled VRF Heat pump
- 9.0 ~ 15.5kW (based on cooling capacity)
- Both 1Ø, 220 ~ 240V, 50Hz and 3Ø, 380 ~ 415V, 50Hz
- Side discharge outdoor unit



WHY R32 REFRIGERANT

Lower Global Warming Potential (GWP)

What is GWP?

Global Warming Potential is a measure that allows for an accurate comparison of the environmental impact of different gases. GWP measures how much energy the emissions of 1 ton of a gas will absorb over a given period of time, relative to the emissions of 1 ton of carbon dioxide (CO₂).

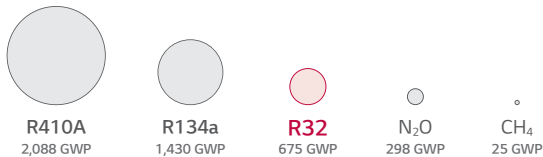

Global Trend and EU Regulation for F-Gas

HFC* Phase Down 79% by 2030.

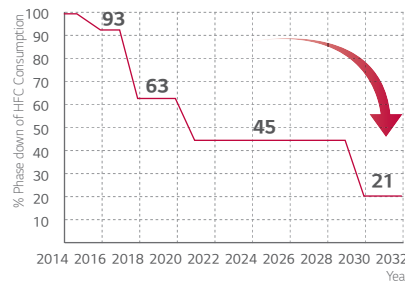

79%
HFCs refrigerants should be reduced by 79% by 2030 compared to 2013.

* Hydrofluorocarbon : One of the alternative freon gas that does not harm the Earth's ozone layer

Cost Savings with R32

Higher Efficiency

Savings on cost of energy consumption.



Reduced Equipment Sizes

Savings on product purchase and labor cost for installation and maintenance.



Less Refrigerant Charge

Savings on cost of injecting & replacing refrigerant.



Reduced Refrigerant Volume

Savings on refrigerant purchase and recycling costs.



Compact Size & Light Weight

Its compact size and light weight make it easy to install and optimize space. (5/6HP)



Less Refrigerant Charge

LG reduced refrigerant charge by applying environment-conscious refrigerant R32.



※ IDU (Wall Mounted Unit) : 5 kBtu/h, 8 EA
 ※ This result can be different depending on actual environment

Corrosion Resistance Black Fin

Enhanced Coating Layers

The black coating with enhanced epoxy resin is applied for strong protection from various corrosive external conditions such as salt contamination and air pollution. Moreover, the hydrophilic film keeps water from accumulating on the heat exchanger's fin, minimizing moisture buildup and eventually making it even more corrosion resistant.

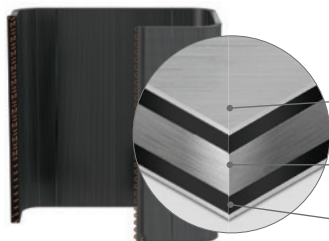

- Hydrophilic Coating (Water flow)**
The Hydrophilic coating minimizes moisture buildup on the fin.
- Complex Resin (Corrosion resistant)**
The Black coating provides strong protection from corrosion.
- Aluminum fin**

※ Verification of corrosion resistance performance
 - Test Method B of ISO 21207
 - ASTM B117 / ISO 9227 (10,000 hours)



R1 Compressor™

R1 Compressor is one that combines high-efficiency, low sound characteristics of the scroll and the simple compressing structure of the rotary compressor. This technology enables a highly efficient compact model.

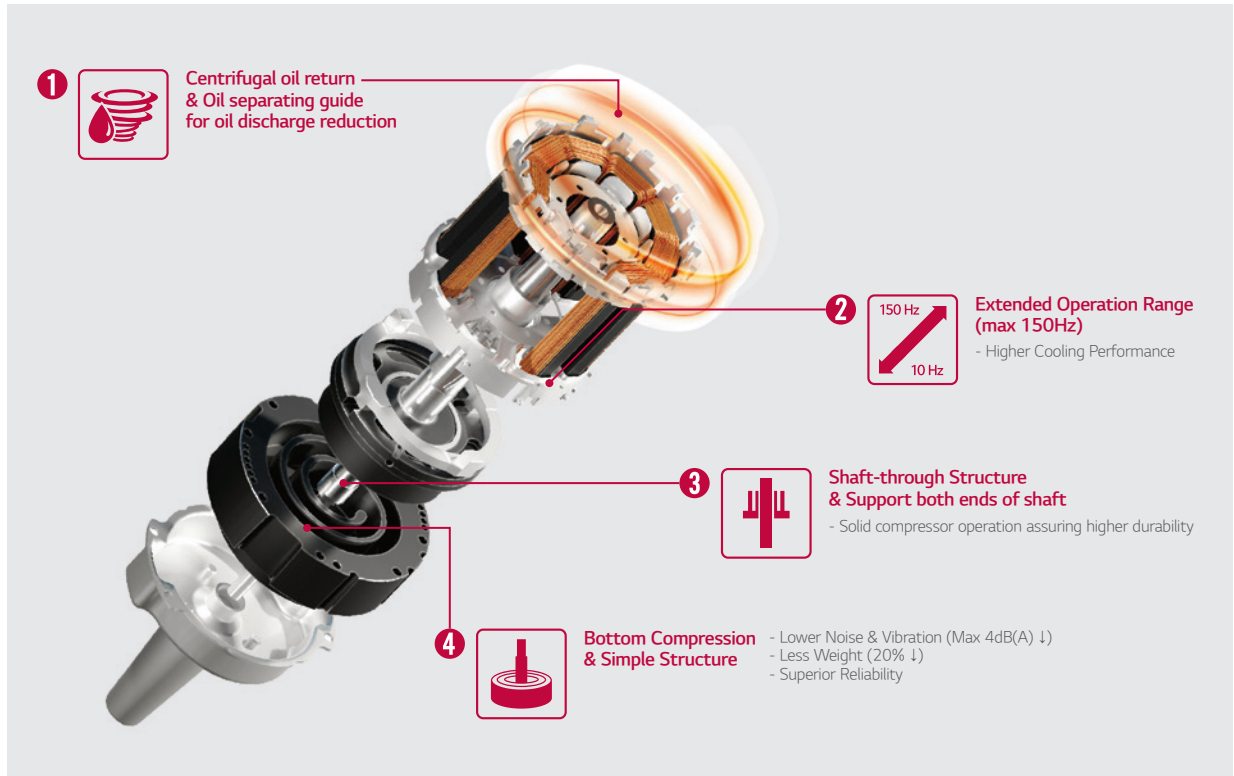

Conventional Compressor

Scroll : High efficiency / Low sound

(Continuous compression, but complex structure)

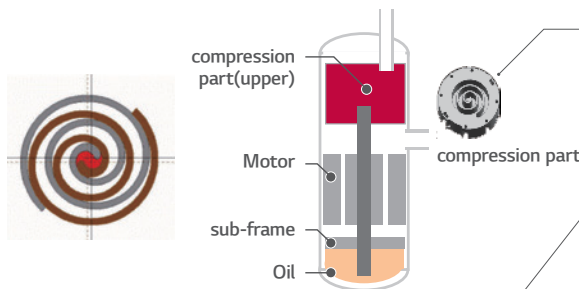

Rotary : Simple structure

(Compression per 1 rotation)

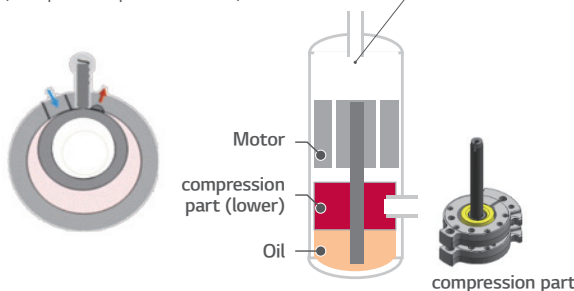

R1 Compressor™

Revolutionary Scroll : High efficiency / Stable & Simple Structure

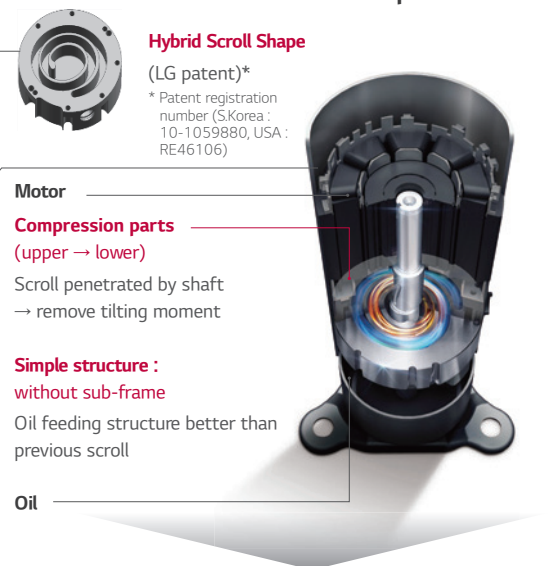

Extended operation (Max 150Hz)
Low noise & Vibration (Max 4dB(A) ↓)
Less weight (20% ↓)

Compact model
(Size 40% ↓, Weight 25% ↓)



ZRUN030GSS0 / ZRUN040GSS0
ZRUN050GSS0 / ZRUN060GSS0



LG participates in the ECP programme for EUROVENT VRF program. Check ongoing validity of certification : www.eurovent-certification.com

HP			3	4	5	6
Model Name			ZRUN030GSS0	ZRUN040GSS0	ZRUN050GSS0	ZRUN060GSS0
Capacity	Cooling (Rated)	kW	9.0	12.1	14.0	15.5
	Heating (Rated)	kW	9.0	12.1	14.0	15.5
	Heating (Max)	kW	10.0	14.2	16.0	18.0
Input	Cooling (Rated)	kW	2.81	4.26	4.90	5.64
	Heating (Rated)	kW	2.09	3.03	3.48	3.95
EER (Rated)			3.20	2.84	2.86	2.75
SEER			5.70	6.69	6.44	6.59
COP (Rated)			4.30	4.00	4.02	3.92
SCOP			3.90	3.87	3.81	4.07
Exterior	Color		Warm Gray	Warm Gray	Warm Gray	Warm Gray
	RAL Code		RAL 7044	RAL 7044	RAL 7044	RAL 7044
Heat Exchanger	Type		Wide Louver Plus	Wide Louver Plus	Wide Louver Plus	Wide Louver Plus
Compressor	Type		LG Inverter Scroll	LG Inverter Scroll	LG Inverter Scroll	LG Inverter Scroll
	Combination x No.		(Inverter) x 1	(Inverter) x 1	(Inverter) x 1	(Inverter) x 1
	Motor Output x Number	W x No.	3,198 x 1	3,198 x 1	3,198 x 1	3,198 x 1
	Oil Type		FW68D (PVE)	FW68D (PVE)	FW68D (PVE)	FW68D (PVE)
	Oil Charge	cc	1,100	1,100	1,100	1,100
Fan	Type		Axial Flow Fan	Axial Flow Fan	Axial Flow Fan	Axial Flow Fan
	Motor Output x Number	W x No.	124 x 1	124 x 1	198 x 1	198 x 1
	Air Flow Rate (High)	m ³ /min x No.	60	60	80	80
	Drive		DC INVERTER	DC INVERTER	DC INVERTER	DC INVERTER
	Discharge	Side / Top	Side	Side	Side	Side
Pipe Connection	Liquid Pipe	mm (inch)	Ø9.52 (3/8)	Ø9.52 (3/8)	Ø9.52 (3/8)	Ø9.52 (3/8)
	Gas Pipe	mm (inch)	Ø15.88 (5/8)	Ø15.88 (5/8)	Ø15.88 (5/8)	Ø19.05 (3/4)
Dimensions (W x H x D)			950 x 834 x 330	950 x 834 x 330	950 x 834 x 330	950 x 834 x 330
Dimensions (W x H x D) - Shipping			1,147 x 919 x 461	1,147 x 919 x 461	1,147 x 919 x 461	1,147 x 919 x 461
Net Weight			64.7	64.7	71.6	71.6
Shipping Weight			73.7	73.7	79.6	79.6
Sound Pressure Level	Cooling	dB(A)	51	51	57	57
	Heating	dB(A)	55	55	60	60
Sound Power Level	Cooling	dB(A)	67	67	70	71
	Heating	dB(A)	70	71	74	75
Communication Cable			mm ² x No. (VCTF-SB)	2C x 1.0 - 1.5	2C x 1.0 - 1.5	2C x 1.0 - 1.5
Refrigerant	Refrigerant name		R32	R32	R32	R32
	Precharged Amount	kg	1.5	1.5	2.0	2.0
	t-CO ₂ eq		1.013	1.013	1.350	1.350
	Control		Electronic Expansion Valve	Electronic Expansion Valve	Electronic Expansion Valve	Electronic Expansion Valve
Power Supply			Ø, V, Hz	220 - 230 - 240, 1, 50	220 - 230 - 240, 1, 50	220 - 230 - 240, 1, 50
Number of maximum connectable indoor units			6	8	10	13

Note

- Due to our policy of innovation some specifications may be changed without notification.
- Wiring cable size must comply with the applicable local and national codes. And "Electric characteristics" chapter should be considered for electrical work and design. Especially the power cable and circuit breaker should be selected in accordance with that.
- Sound pressure level is measured on the rated condition in the anechoic rooms by ISO 3745 standard. Sound power level is measured on the rated condition in the semi-anechoic rooms by ISO 9614 standard. Therefore, these values can be increased owing to ambient conditions during operation.

4. Performances are based on the following conditions :

- Cooling : Indoor Ambient Temp 27°CDB / 19°CWB, Outdoor Ambient Temp 35°CDB / 24°CWB
- Heating : Indoor Ambient Temp 20°CDB / 15°CWB, Outdoor Ambient Temp 7°CDB / 6°CWB
- Interconnected Pipe Length is 7.5m and difference of Elevation (Outdoor - Indoor Unit) is 0m.

5. EUROVENT Test Condition :

- Performance values on this PDB are based on Ceiling mounted cassette combination.
- Refer to EUROVENT web site(www.eurovent-certification.com) for other indoor unit combination and more detail test conditions.
- The maximum combination ratio is 160%.
- This product contains Fluorinated greenhouse gases (R32, GWP (Global warming potential) = 675)

ZRUN030LSS0 / ZRUN040LSS0
ZRUN050LSS0 / ZRUN060LSS0



LG participates in the ECP programme for EUROVENT VRF program. Check ongoing validity of certification : www.eurovent-certification.com

HP			3	4	5	6
Model Name			ZRUN030LSS0	ZRUN040LSS0	ZRUN050LSS0	ZRUN060LSS0
Capacity	Cooling (Rated)	kW	9.0	12.1	14.0	15.5
	Heating (Rated)	kW	9.0	12.1	14.0	15.5
	Heating (Max)	kW	10.0	14.2	16.0	18.0
Input	Cooling (Rated)	kW	2.81	4.26	4.90	5.64
	Heating (Rated)	kW	2.09	3.03	3.48	3.95
EER (Rated)			3.20	2.84	2.86	2.75
SEER			5.70	6.69	6.44	6.59
COP (Rated)			4.30	4.00	4.02	3.92
SCOP			3.90	3.87	3.81	4.07
Exterior	Color		Warm Gray	Warm Gray	Warm Gray	Warm Gray
	RAL Code		RAL 7044	RAL 7044	RAL 7044	RAL 7044
Heat Exchanger	Type		Wide Louver Plus	Wide Louver Plus	Wide Louver Plus	Wide Louver Plus
Compressor	Type		LG Inverter Scroll	LG Inverter Scroll	LG Inverter Scroll	LG Inverter Scroll
	Combination x No.		(Inverter) x 1	(Inverter) x 1	(Inverter) x 1	(Inverter) x 1
	Motor Output x Number	W x No.	3,198 x 1	3,198 x 1	3,198 x 1	3,198 x 1
	Oil Type		FW68D (PVE)	FW68D (PVE)	FW68D (PVE)	FW68D (PVE)
	Oil Charge	cc	1,100	1,100	1,100	1,100
Fan	Type		Axial Flow Fan	Axial Flow Fan	Axial Flow Fan	Axial Flow Fan
	Motor Output x Number	W x No.	124 x 1	124 x 1	198 x 1	198 x 1
	Air Flow Rate (High)	m ³ /min x No.	60	60	80	80
	Drive		DC INVERTER	DC INVERTER	DC INVERTER	DC INVERTER
	Discharge	Side / Top	Side	Side	Side	Side
Pipe Connection	Liquid Pipe	mm (inch)	Ø9.52(3/8)	Ø9.52 (3/8)	Ø9.52 (3/8)	Ø9.52 (3/8)
	Gas Pipe	mm (inch)	Ø15.88(5/8)	Ø15.88 (5/8)	Ø15.88 (5/8)	Ø19.05 (3/4)
Dimensions (W x H x D)			950 x 834 x 330	950 x 834 x 330	950 x 834 x 330	950 x 834 x 330
Dimensions (W x H x D) - Shipping			1,147 x 919 x 461	1,147 x 919 x 461	1,147 x 919 x 461	1,147 x 919 x 461
Net Weight			64.7	64.7	71.6	71.6
Shipping Weight			73.7	73.7	79.6	79.6
Sound Pressure Level	Cooling	dB(A)	51	51	57	57
	Heating	dB(A)	55	55	60	60
Sound Power Level	Cooling	dB(A)	67	67	70	71
	Heating	dB(A)	70	71	74	75
Communication Cable			2C x 1.0 ~ 1.5	2C x 1.0 ~ 1.5	2C x 1.0 ~ 1.5	2C x 1.0 ~ 1.5
Refrigerant	Refrigerant name		R32	R32	R32	R32
	Precharged Amount	kg	1.5	1.5	2.0	2.0
	t-CO ₂ eq		1.013	1.013	1.350	1.350
	Control		Electronic Expansion Valve	Electronic Expansion Valve	Electronic Expansion Valve	Electronic Expansion Valve
Power Supply			Ø, V, Hz	380 - 400 - 415, 3, 50	380 - 400 - 415, 3, 50	380 - 400 - 415, 3, 50
Number of maximum connectable indoor units			6	8	10	13

Note

- Due to our policy of innovation some specifications may be changed without notification.
- Wiring cable size must comply with the applicable local and national codes. And "Electric characteristics" chapter should be considered for electrical work and design. Especially the power cable and circuit breaker should be selected in accordance with that.
- Sound pressure level is measured on the rated condition in the anechoic rooms by ISO 3745 standard. Sound power level is measured on the rated condition in the semi-anechoic rooms by ISO 9614 standard. Therefore, these values can be increased owing to ambient conditions during operation.

4. Performances are based on the following conditions :

- Cooling : Indoor Ambient Temp 27°CDB / 19°CWB, Outdoor Ambient Temp 35°CDB / 24°CWB
 - Heating : Indoor Ambient Temp 20°CDB / 15°CWB, Outdoor Ambient Temp 7°CDB / 6°CWB
 - Interconnected Pipe Length is 7.5m and difference of Elevation (Outdoor - Indoor Unit) is 0m.
5. EUROVENT Test Condition :
- Performance values on this PDB are based on Ceiling mounted cassette combination.
 - Refer to EUROVENT web site(www.eurovent-certification.com) for other indoor unit combination and more detail test conditions.
6. The maximum combination ratio is 160%.
7. This product contains Fluorinated greenhouse gases. (R32, GWP (Global warming potential) = 675)

MULTI V™ M

140m
Total Piping Length

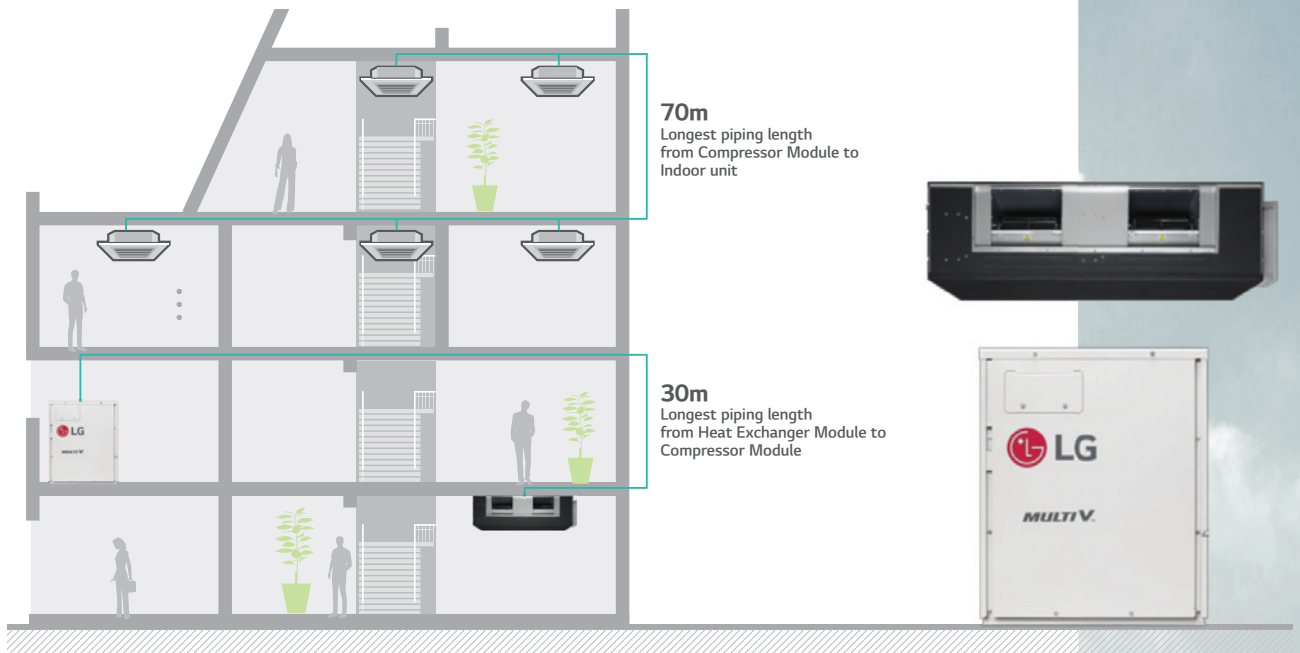

Highlight



Flexible design



Cost savings



Space savings



Easy maintenance

- Air Cooled VRF Heat Pump
- 14kW (based on cooling capacity)
- 3Ø, 380 ~ 415V, 50Hz (Compressor Module)
- 1Ø, 220 ~ 240V, 50Hz (Heat Exchanger Module)
- Outdoor unit is installed inside building

How does it work?

Direct Inlet / Outlet Case

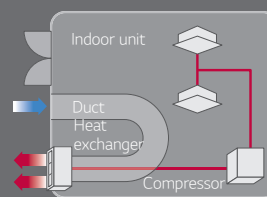

Duct Connected Case

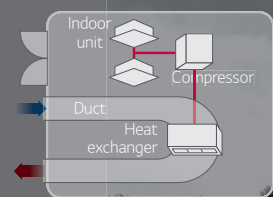



OUTDOOR UNITS

MULTI V M

Energy Efficiency

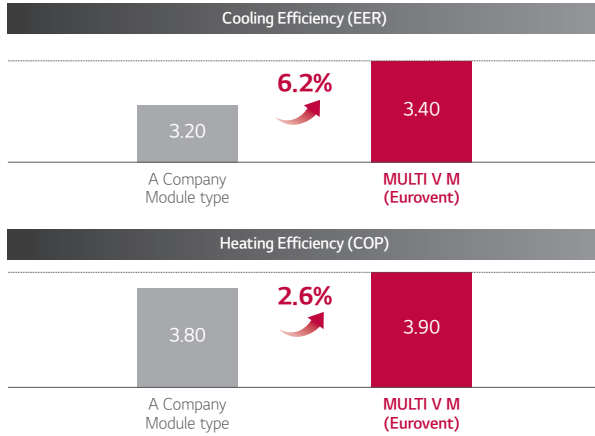

R1 Compressor™

MULTI V M ensures world-class efficiency with innovative technology including R1 Compressor.

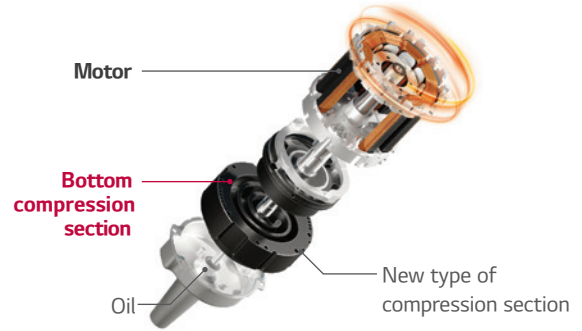

Smart Load Control

To save operation energy consumption, automatically controls the refrigerant temperature according to outdoor temperature.

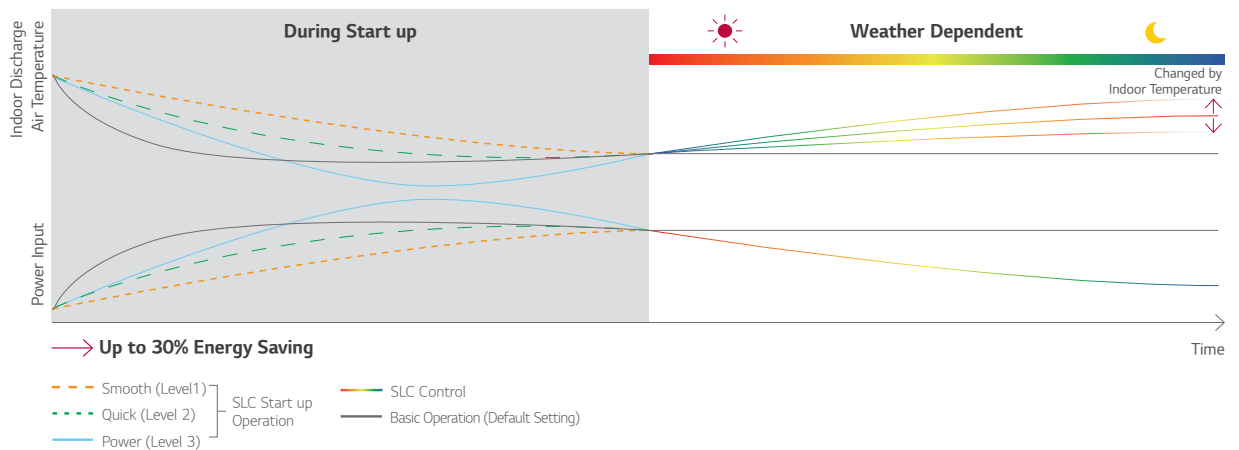
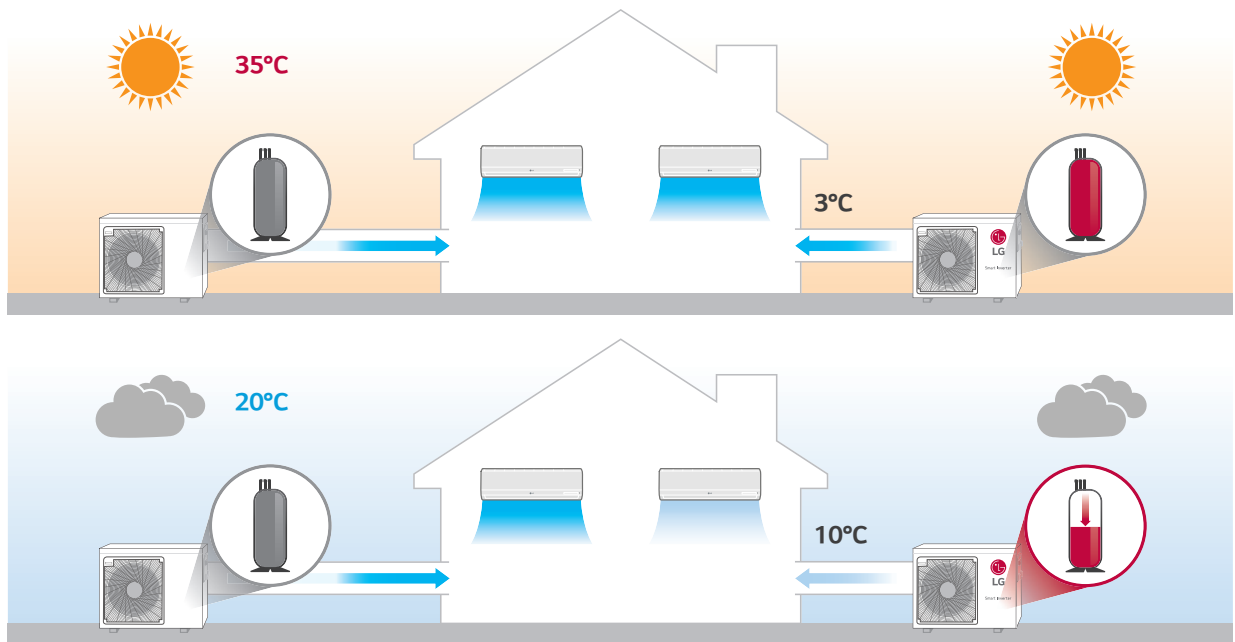

Wide Louver Plus Fin + Corrosion Resistance

Wide Louver Plus fin technology increases efficiency and heating performance compared to conventional fin.

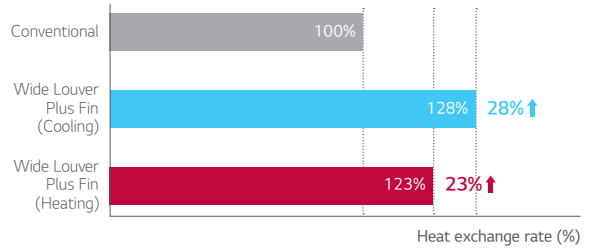

Quiet Operation

Low sound level of both compressor module and heat exchanger module allows outdoor units to be installed and operated inside.

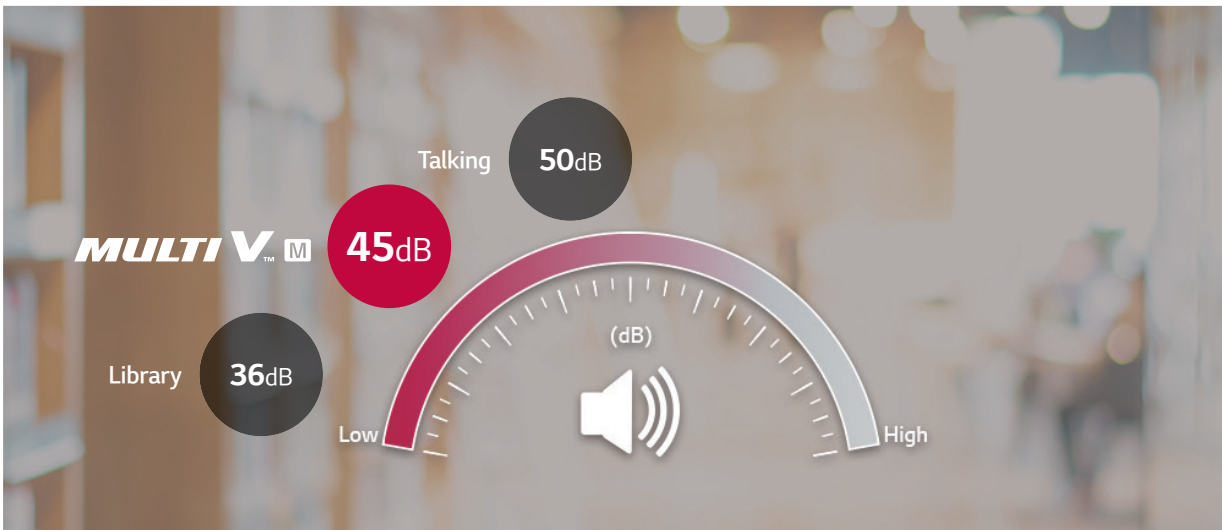

Volume

Compressor Module

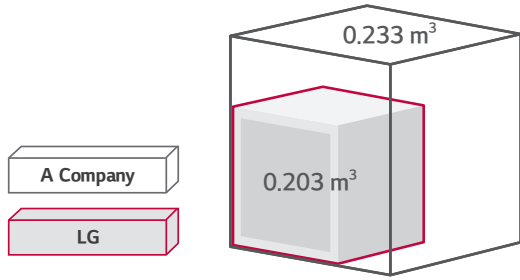

Heat Exchanger Module

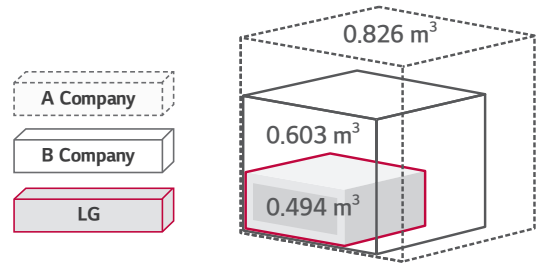

ESP Control (External Static Pressure)

up to 30 Pa



Normal Mode

up to 157 Pa (max)

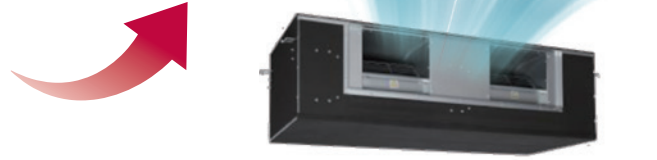

High Static Pressure Mode

Module Type

Increased design freedom

- Additional structure installation and ceiling construction not required
- Ease of service
- Compressor replacement
- Low noise with module
- Low noise by module (vs Integrated Type)

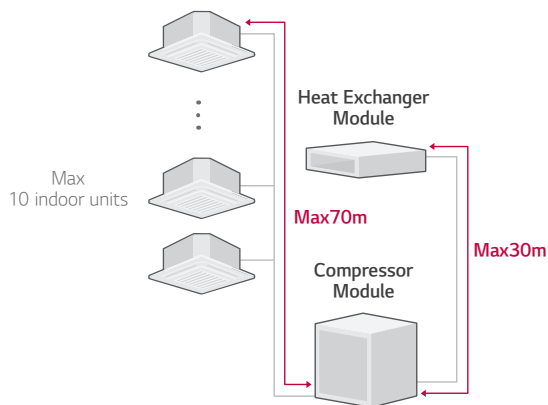

Flexible Piping Location

Tidy & simple installation with flexible piping location.

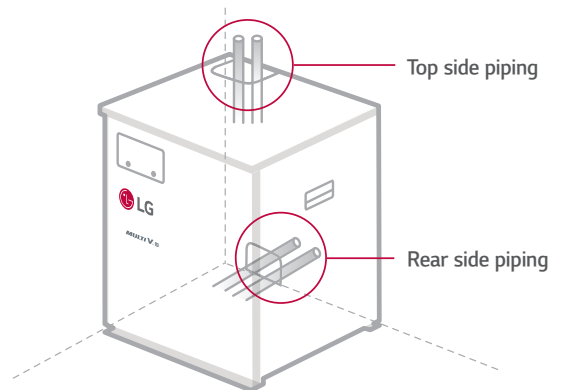

Increased Design Freedom

Additional structure installation or ceiling construction is not required, making compressor replacement and general maintenance easier. Split module provides low noise operation compared to integrated type.



Conventional Outdoor Unit

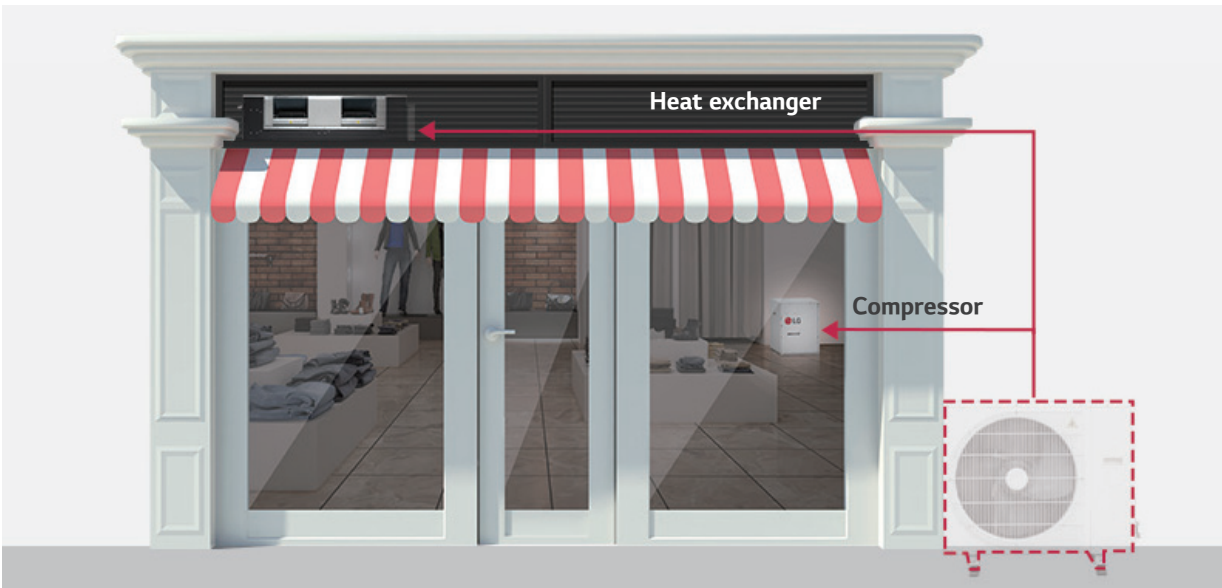

MULTI V™ M

Heat exchanger module can be installed in false ceiling spaces



Compressor module can be installed anywhere indoors



Nomenclature

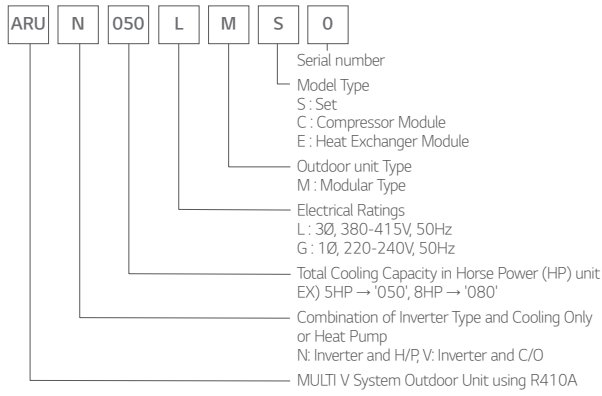

Outdoor Units Function

Category	Functions	Modular
Key Refrigerant Components	Variable Path of Outdoor Unit HEX	-
	HIPOR™ (High Pressure Oil Return)	-
	Humidity Sensor	-
	Corrosion Resistance Black Fin	○
	Oil Sensor	-
Useful Function	Dual Sensing	-
	Low Noise Operation	○
	High Static Mode of Outdoor Unit Fan	○
	Partial Defrosting	-
	Auto Dust Cleaning of Outdoor Unit (Fan reverse rotation)	-
Reliability	Indoor Cooling Comfort Mode Based Outdoor Temperature	○
	Smart Load Control (SLC) (Changing indoor discharge air temperature according to load)	○
	Outdoor Unit Control Refer to Humidity	-
	Defrost / Deicing	○
	High Pressure Switch	○
Central Controller	Phase Protection	○
	Restart Delay (3-minutes)	○
	Self Diagnosis	○
	Soft Start	○
	Test Run Function	-
BNU (Building Network Unit)	AC Ez (Simple Controller)	PQCSZ250S0
	AC Ez Touch	PACEZA000
	AC Smart IV	PACS4B000
	AC Smart 5	PACS5A000
	ACP (Advanced Control Platform) IV	PACP4B000
Installation	ACP (Advanced Control Platform) 5	PACP5A000
	AC Manager 5	PACMSA000
	ACP5 (w U60FT)	○
	ACP BACnet	PQNF17C0
	Refrigerant Charging Kit	-
PDI (Power Distribution Indicator)	Variable Water Flow Valve Control Kit	-
	Standard	-
	Premium	-
	Cool / Heat Selector	PRDSBM
	Low Ambient Kit	-
IO Module (ODU Dry Contact)		PVDSMN000
	Cycle Monitoring Device LGMV	PRCTILO
	Mobile LGMV	PLGMVW100

※ ○ : Applied, - : Not Applied

Heat Pump

Cooling

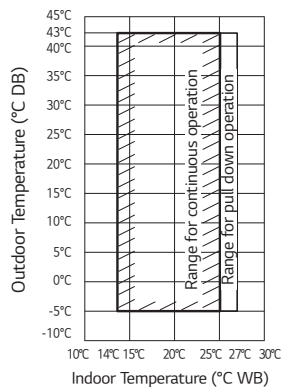

Heating

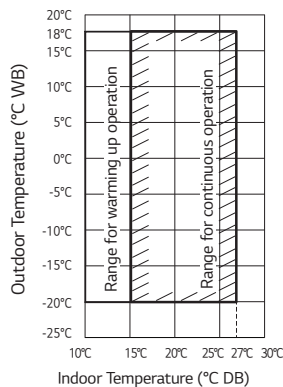

Compressor Module

[Unit : mm]

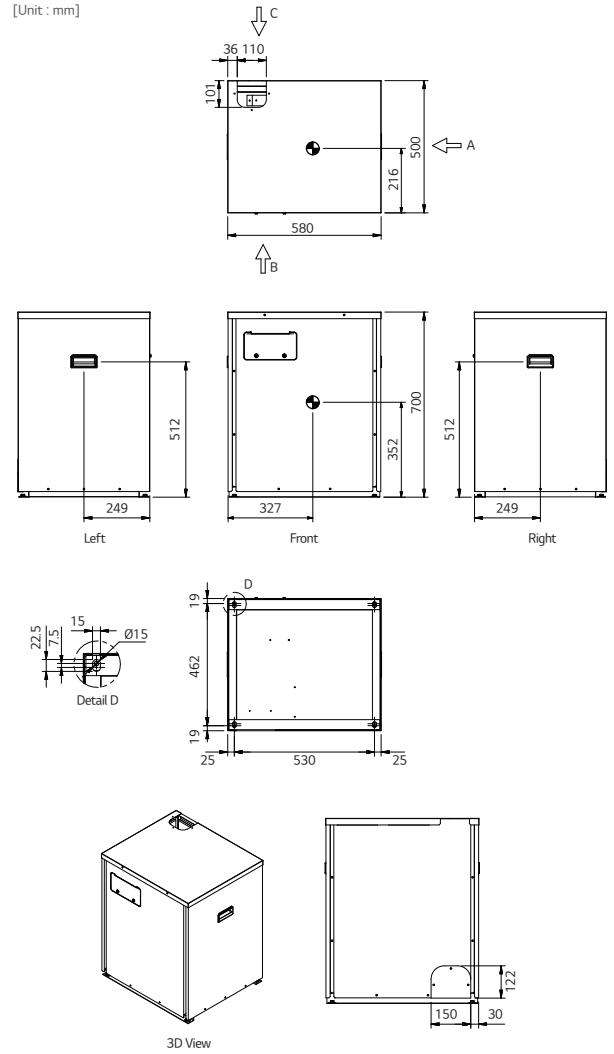

Heat Exchanger Module

[Unit : mm]

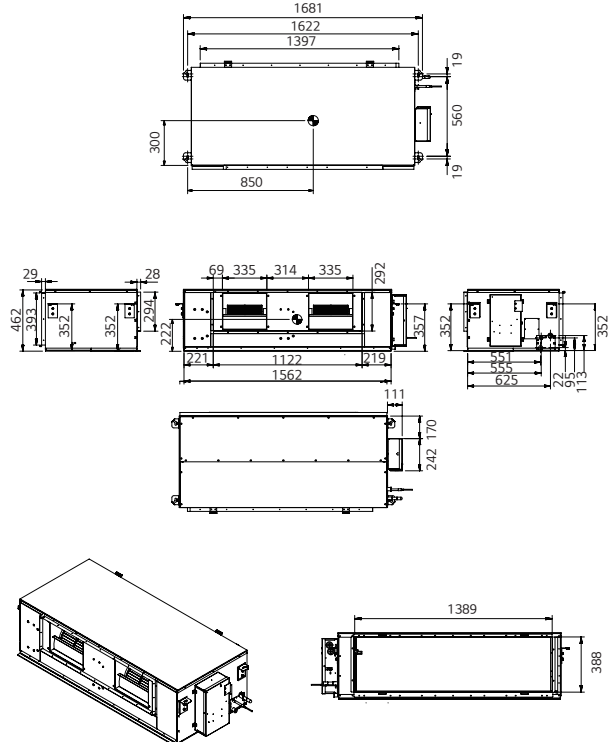

Position of Sound Pressure Level Measuring

Compressor Module

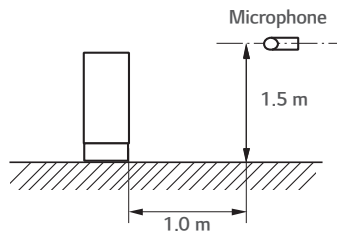

※ Measuring place : Anechoic chamber

Heat Exchanger Module

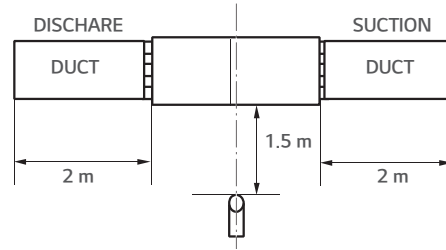

※ Measuring place : Anechoic chamber

Installation Space for Compressor Module

Top View

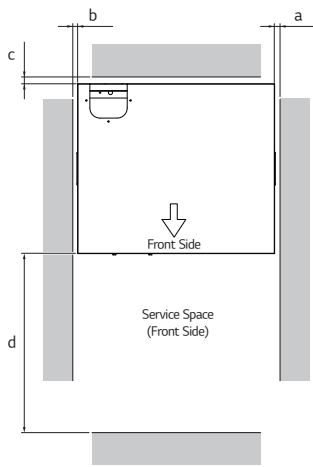

Front View

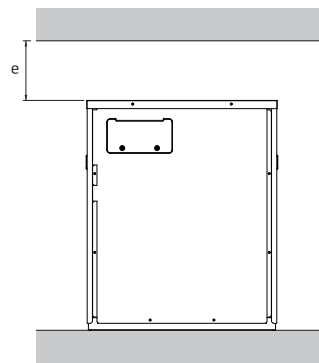

Category	Mark	Description	Installation Space (mm)
Compressor Module	a	Right	10 or More
	b	Left	10 or More
	c	Rear	10 or More
	d	Front	500 or More
	e	Top	200 or More

Installation Space for Compressor Module

Top View

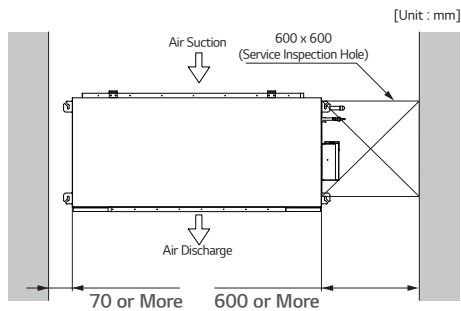

Front View

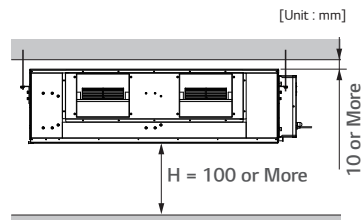

ARUN050LMCO / ARUN050GMEO

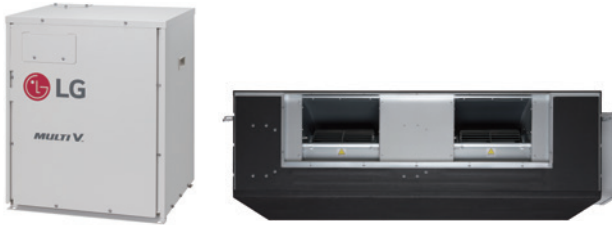

LG participates in the ECP programme for EUROVENT VRF program. Check ongoing validity of certification : www.eurovent-certification.com

System

HP		5
Model Name	Set	ARUN050LMSO
	Compressor Module	ARUN050LMCO
	Heat Exchanger Module	ARUN050GMEO
Capacity	Cooling (Rated) kW	14.0
	Heating (Rated) kW	14.0
	Heating (Max) kW	16.0
Input	Cooling (Rated) kW	5.07
	Heating (Rated) kW	3.71
	Heating (Max) kW	4.32
EER	Based on Rated Capacity	2.76
SEER		5.26
COP	Based on Rated Capacity	3.77
	Based on Max Capacity	3.70
SCOP		3.85
Number of Maximum Connectable Indoor Units		10

※ O : Applied, - : Not Applied

Note

- Due to our policy of innovation some specifications may be changed without notification.
- Wiring cable size must comply with the applicable local and national codes. And "Electric characteristics" chapter should be considered for electrical work and design. Especially the power cable and circuit breaker should be selected in accordance with that.
- Power factor could vary less than ±1% according to the operating conditions.
- Sound pressure level is measured on the rated condition in the anechoic rooms by ISO 3745 standard. Sound power level is measured on the rated condition in the semi-anechoic rooms by ISO 9614 standard. Therefore, these values can be increased owing to ambient conditions during operation.
- Performances are based on the following conditions :
 - Cooling : Indoor Ambient Temp 27°CDB / 19°CWB, Outdoor Ambient Temp 35°CDB / 24°CWB
 - Heating : Indoor Ambient Temp 20°CDB / 15°CWB, Outdoor Ambient Temp 7°CDB / 6°CWB
 - Interconnected Pipe Length and Difference of Elevation : - Heat Exchanger Module - Compressor Module = 5m
 - Compressor Module - Indoor Unit = 7.5m
 - Difference of Elevation (Heat Exchanger Module- Compressor Moduler - Indoor Unit) is Zero
- The maximum combination ratio is 130%.
- This product contains Fluorinated greenhouse gases. (R410A, GWP(Global warming potential) = 2,087.5)

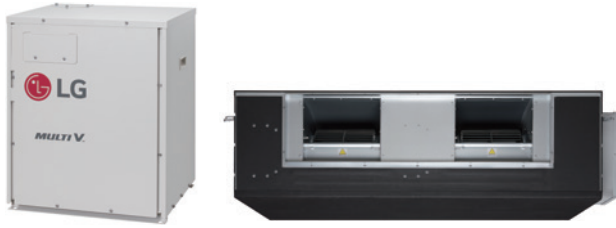

LG participates in the ECP programme for EUROVENT VRF program. Check ongoing validity of certification : www.eurovent-certification.com

Module

HP			5	
Model Name			Compressor Module	Heat Exchanger Module
			ARUN050LMC0	ARUN050GME0
Exterior	Color		Morning Gray	Galvanized Steel Plate
	RAL Code (Classic)		RAL 7030	-
Dimensions (W x H x D)	Net	mm x No.	580 x 700 x 500	1,562 x 460 x 688
	Shipping	mm x No.	618 x 833 x 564	1,806 x 537 x 825
Weight	Net	kg x No.	69.0	84
	Shipping	kg x No.	76.0	95
Compressor	Type		Hermetic Motor Compressor	-
	Combination x No.		(Inverter) x 1	-
	Motor Output	W x No.	3,200	-
	Oil Type		FW68D (PVE)	-
	Oil Charge	cc	1,300	-
Heat Exchanger	Type		-	Wide Louver Plus
Fan	Type		-	Sirocco Fan
	Motor Output x Number	W x No.	-	400 x 2
	Air Flow Rate (Rated)	m ³ /min x No.	-	60
External Static Pressure	Nominal (Rated, Factory Set)	mmAq (Pa)	-	3 (29)
	Max	mmAq (Pa)	-	16 (157)
Pipe Connection	Liquid	mm (inch)	Ø9.52 (3/8) to IDU	Ø12.7 (1/2) to Comp. Module
	Gas	mm (inch)	Ø15.88 (5/8) to IDU	Ø19.05 (3/4) to Comp. Module
	Drain	mm (inch)	-	25(1)
Sound Pressure Level	Cooling (Rated)	dB(A)	45	45
	Heating (Rated)	dB(A)	45	45
Sound Power Level		dB(A)	-	-
Communication Cable		mm ² x No. (VCTF-SB)	2C x 1.0 ~ 1.5 to IDU	2C x 1.0 ~ 1.5 to Comp. Module
Refrigerant	Refrigerant Name		R410A	R410A
	Precharged Amount	kg	2.0	-
	t-CO ₂ eq		4,175	-
	Control		-	Electronic Expansion Valve
Power Supply		V, Ø, Hz	380-415 V, 3, 50	220-240 V, 1, 50

※ O : Applied, -: Not Applied

Note

- Due to our policy of innovation some specifications may be changed without notification.
- Wiring cable size must comply with the applicable local and national codes. And "Electric characteristics" chapter should be considered for electrical work and design. Especially the power cable and circuit breaker should be selected in accordance with that.
- Power factor could vary less than ±1% according to the operating conditions.
- Sound pressure level is measured on the rated condition in the anechoic rooms by ISO 3745 standard. Sound power level is measured on the rated condition in the semi-anechoic rooms by ISO 9614 standard. Therefore, these values can be increased owing to ambient conditions during operation.
- Performances are based on the following conditions :
 - Cooling : Indoor Ambient Temp 27°CDB / 19°CWB, Outdoor Ambient Temp 35°CDB / 24°CWB
 - Heating : Indoor Ambient Temp 20°CDB / 15°CWB, Outdoor Ambient Temp 7°CDB / 6°CWB
 - Interconnected Pipe Length and Difference of Elevation : - Heat Exchanger Module - Compressor Module = 5m
 - Compressor Module - Indoor Unit = 7.5m
 - Difference of Elevation (Heat Exchanger Module- Compressor Module - Indoor Unit) is Zero
- The maximum combination ratio is 130%.
- This product contains Fluorinated greenhouse gases. (R410A, GWP(Global warming potential) = 2,087.5)

MULTI V™ WATER5

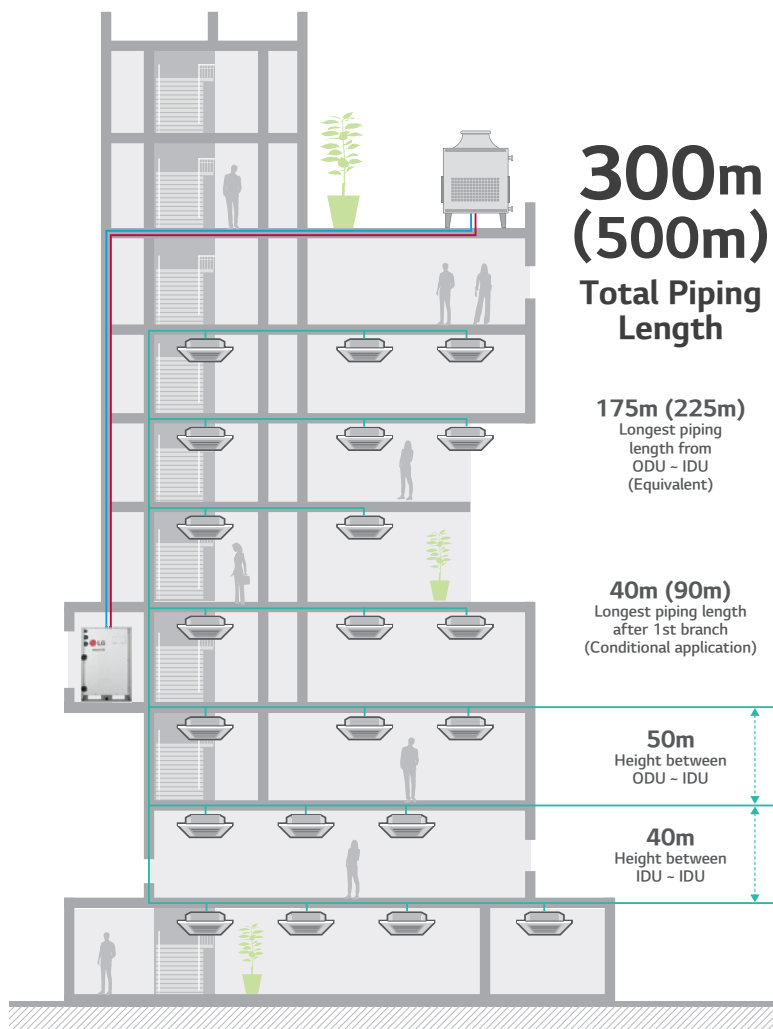

Highlight



Energy savings



Reliability



Convenience

- Water Cooled VRF Heat Pump & Heat Recovery
- 22.4 ~ 168kW (Cooling capacity based)
- 3Ø, 380 ~ 415V, 50Hz
- Outdoor unit installed indoor

How does it work?

Available in Heat Pump & Heat Recovery Configuration

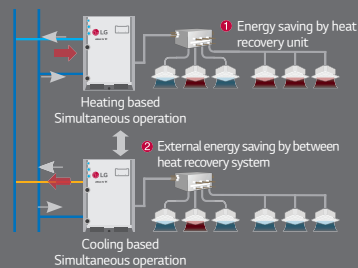

Combination of Cooling, Heating and Hot Water Solution

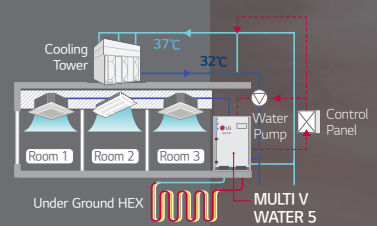

Operation independent of weather conditions



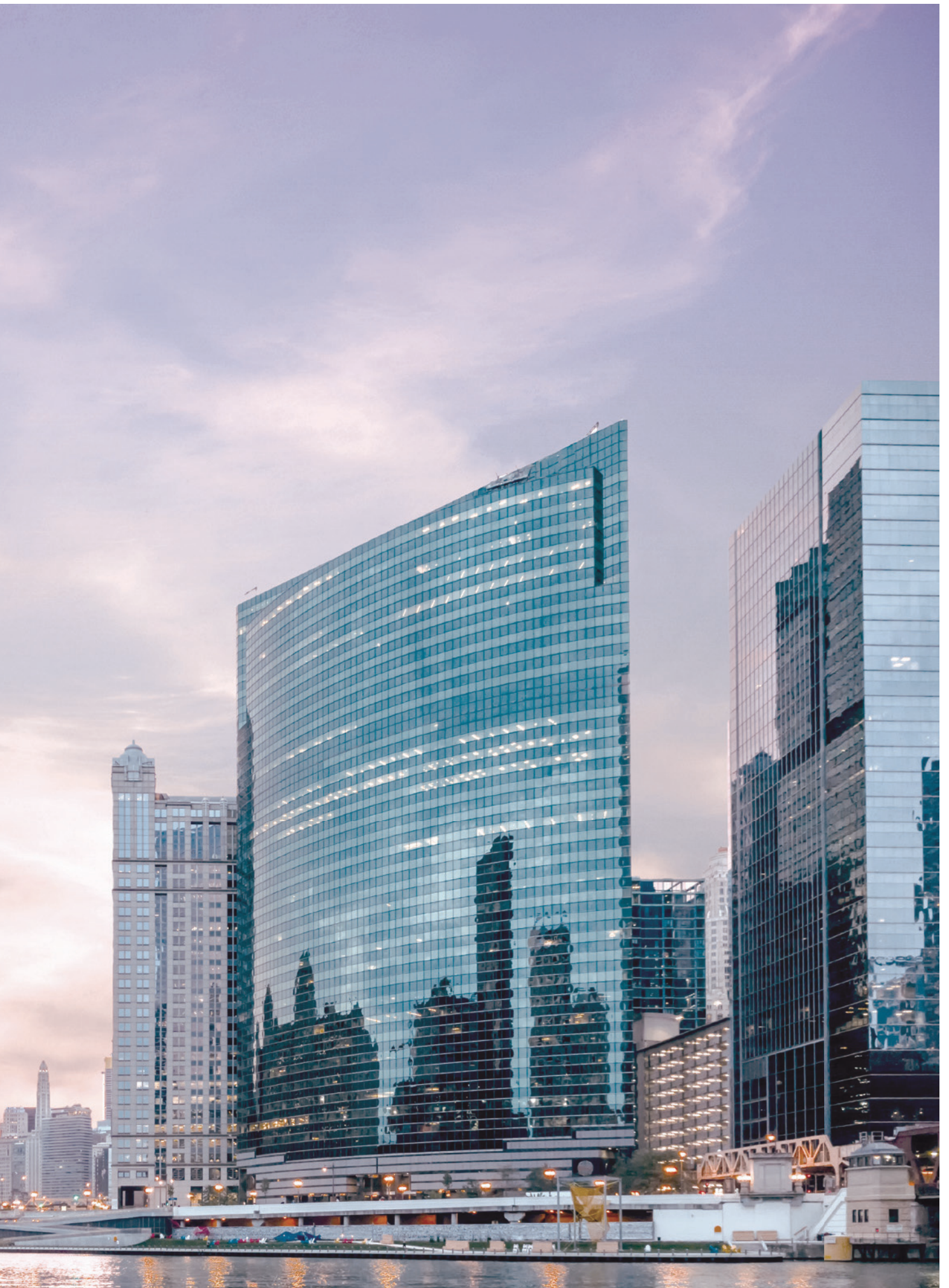

OUTDOOR UNITS

MULTI V WATER 5

High Efficiency System Regardless of External Conditions

Regardless of outdoor temperature and other environmental conditions, MULTI V WATER 5 is the optimal solution.

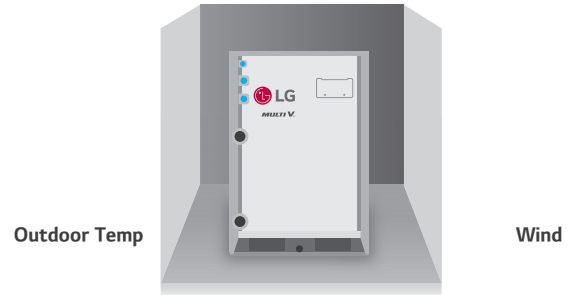

MULTI V WATER 5 System for Geothermal Applications

Uses underground heat sources like soil, ground water, lakes, rivers and more as renewable energy for cooling and heating. Water or antifreeze solution is circulated through the closed loop HDPE (High Density Poly-Ethylene) pipes buried beneath the earth's surface.

- The Circulating water temperature range is between -5°C ~ 45°C
- Antifreeze should be applied depending on the application

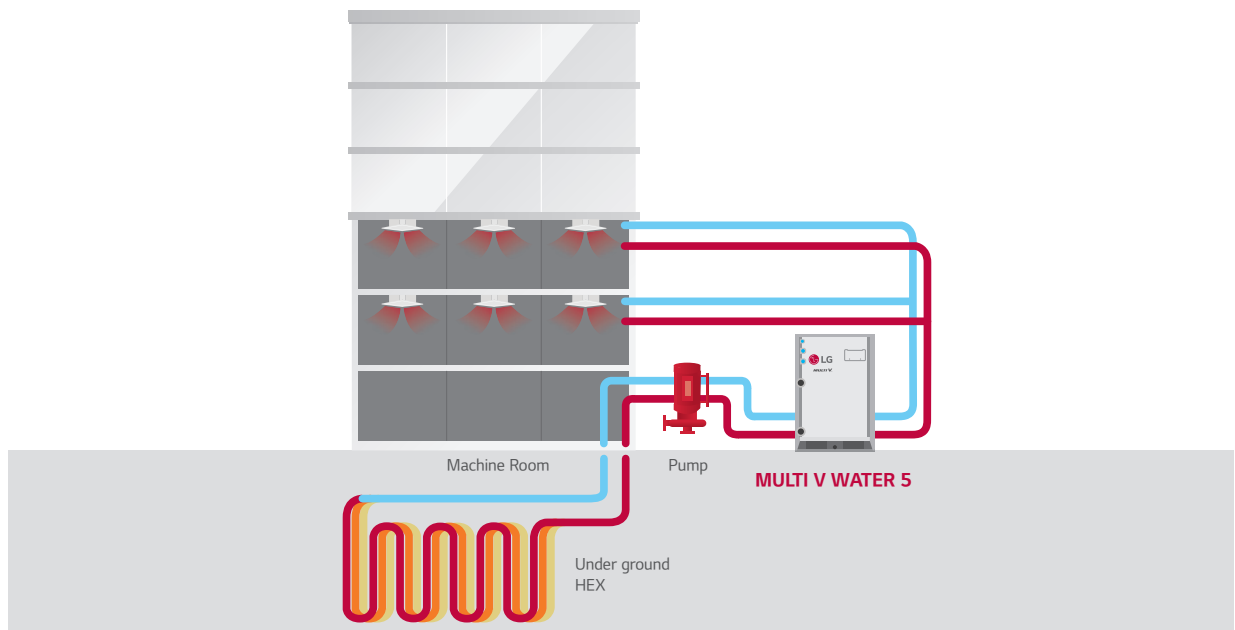

Chiller - FCU

Multi V Water 5

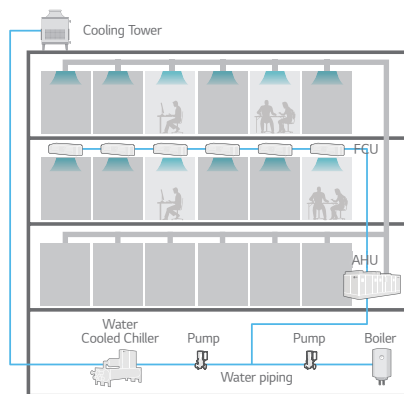

Central control

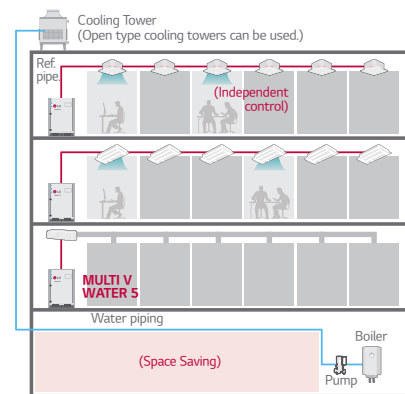

Independent control

Economical, Highly Efficient System

LG's key technologies are integrated to inverter compressor

With 5th generation inverter compressor, the Multi V Water 5 boasts top-class energy efficiency.

6 By-pass Valve

- Maximize part load efficiency through 6 By-pass Valve
- High pressure loss reduction in part load operation

Enhanced Bearing Technology

- High lubricity PEEK (Polyether ether keHPe) bearing
- Outer bearing
- Compact, less vibration and bearing loading
- Increased bearing performance in oil-less operation

Extended C ompressor Speed 20Hz ~ 150Hz

- Rapid operation response
- Capable of reaching required temperature quickly
- Increase part load efficiency

HiPOR™ (High Pressure Oil R eturn)

- Eliminating loss in suction gas by returning oil directly to compressor
- Resolve compressor efficiency loss caused by oil return

Active Oil Control (Oil Level Sensor)

- Oil recovery operation occurs only when required
- Enhanced compressor reliability & continuous heating
- Oil distribution between compressors

Friction Coefficient (Defect) vs Time

Material	Time (sec)	Friction Coefficient (Defect)
Aluminum	50	Low
LG 4 th Gen	240	Low
LG 5 th Gen	275	Low

EER Comparison

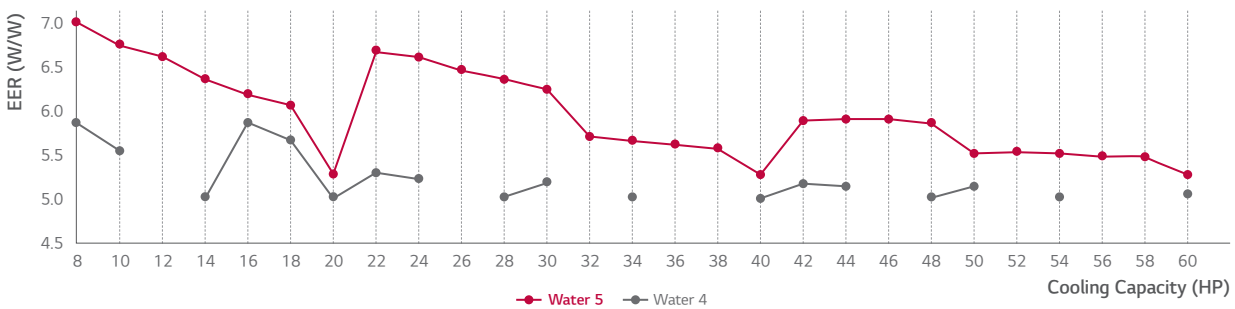

Economical, Highly Efficient System

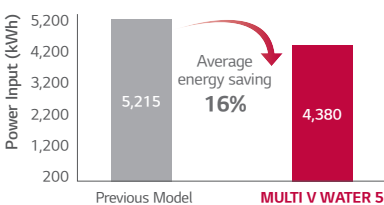

Energy Efficiency Ratio (Cooling)

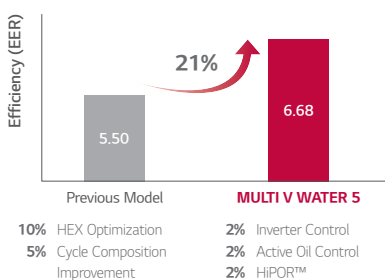

Coefficient of Performance (Heating)

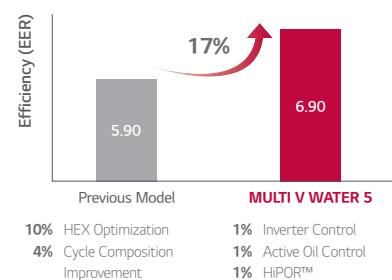

※ Comparison between 10HP (28kW)
 ※ Comparing to previous MULTI V WATER model

Dual Sensing Control

MULTI V WATER 5 can operate more appropriately in low humidity conditions by referring to the indoor temperature and humidity.

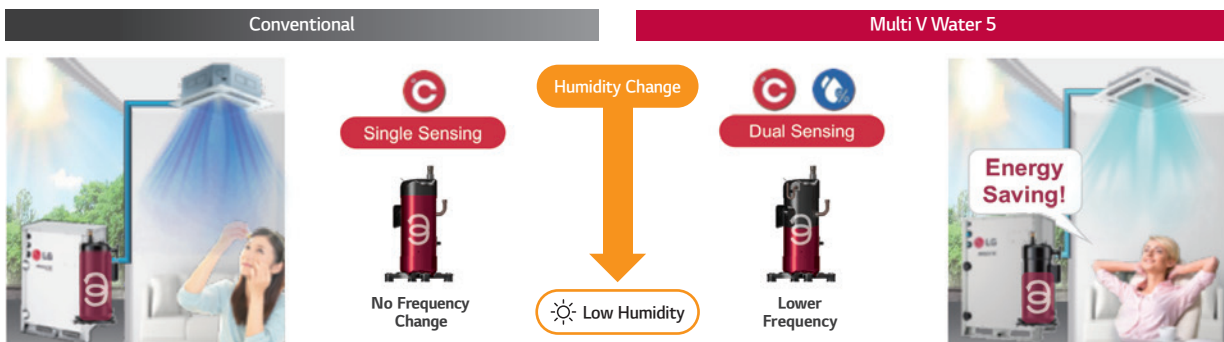

※ This function requires the indoor unit to be equipped with a humidity sensor, the CRC1 remote controller or the Standard III remote controller.

Refrigerant Liquid-cooled Inverter Drive

MULTI V WATER 5 can remove heat from inverter PCB through Refrigerant-Cooling Heat Sink

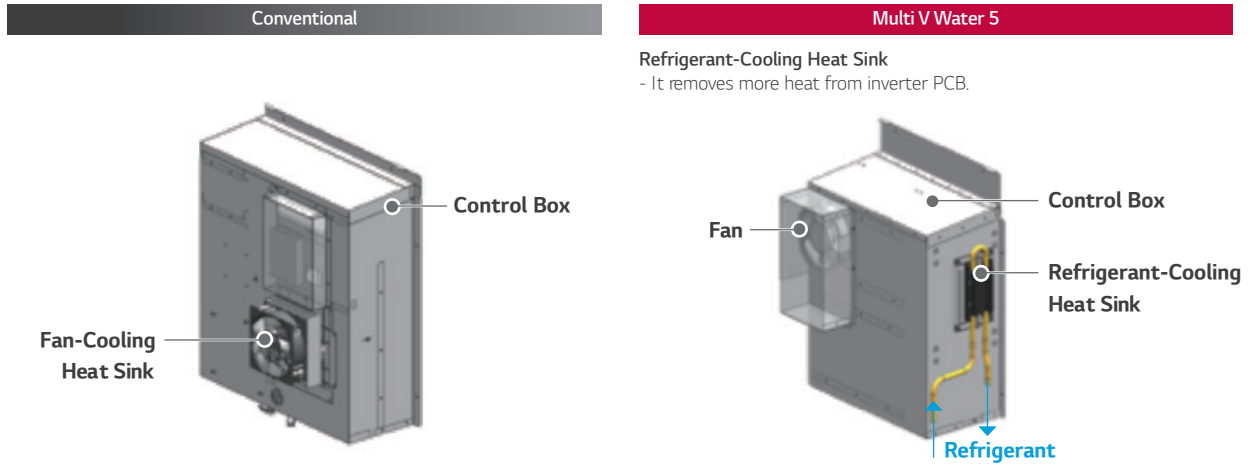

Largest Capacity

Sufficient pipe length limitation provides flexible design and installation

Providing 8 ~ 20HP (22.4 ~ 56kW) with single unit, and up to the world's largest capacity 60HP (168kW) by combination.

v	8	10	12	14	16	18	20	22	24	26	28	30	32	34	36	38	40	42	44	46	48	50	52	54	56	58	60
kW	22.4	28	33.6	39.2	44.8	50.4	56	61.6	67.2	72.8	78.4	84	89.6	95.2	100.8	106.4	112	117.6	123.2	128.8	134.4	140	145.6	151.2	156.8	162.4	168
LG	1 Unit							2 Units							3 Units												

Longest Piping Length

Sufficient pipes length limitation in design and Installation for various buildings

Provide flexible installation up to 300m (500m) of total piping length. As water pipes are not connected to indoor units, users are free from water leakage problems.

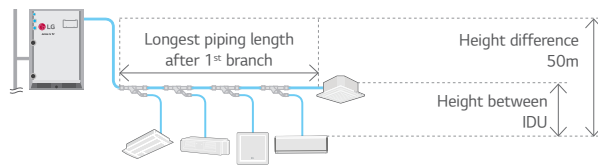

Total Piping Length	300m (500m)
Actual longest piping length (Equivalent)	175m (225m)
Longest piping length after 1st branch (Conditional application)	40m (90m)
Height difference between ODU - IDU	50m
Height difference between IDU - IDU	40m

Compact Size

Thanks to compact size of product, it provides more space for commercial or public use as much as possible.

The optimal design of the compact, lightweight outdoor unit enables double stacking, which results in 50% savings in installation space.

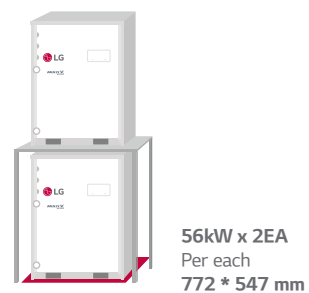

Variable Water Flow Control (OPTION)

In support of green building initiatives

The world's first variable water flow control system for water cooled VRF system. LG applied Variable Water Flow Control to optimize water flow control regarding partial cooling or heating load conditions. Because of this it's also possible to reduce circulation pump energy consumption.

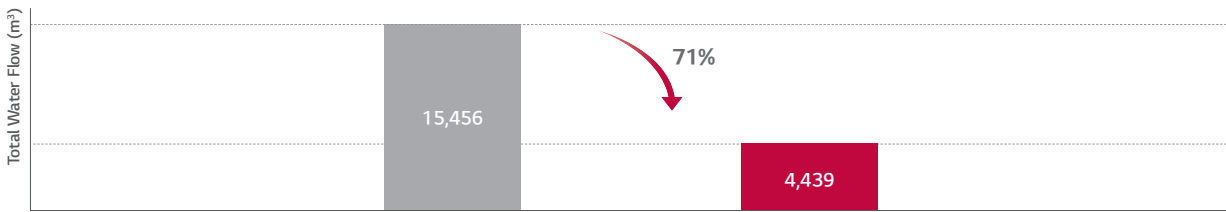
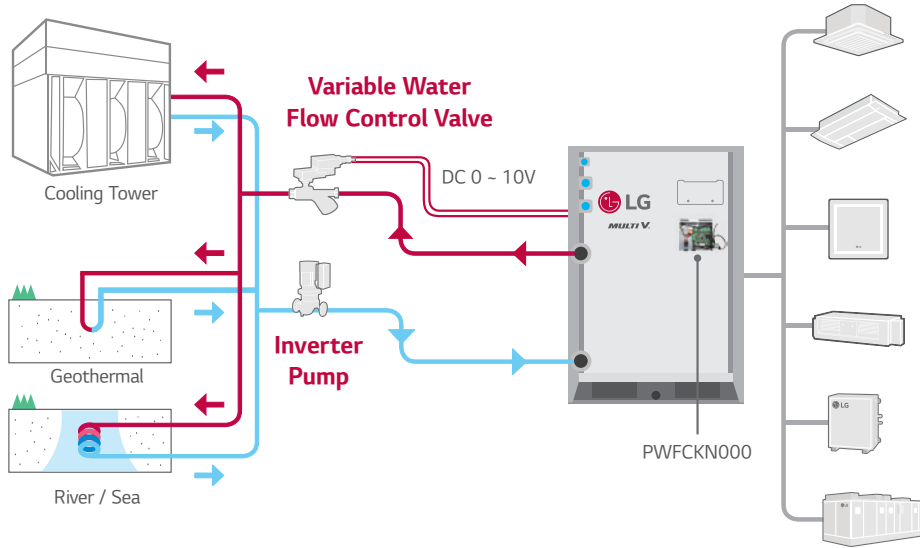

※ Variable Water Flow vs. Constant Water Flow

Constant Water Flow

Variable Water Flow

Note

1. Location : Paris, France
2. Office, 68,000m²
3. Operation time : 1,344 hours (Cooling period)

Project Example : 63F (Pump : 20,064 LPM, 42.4mAq x 4ea)

- 1) Inverter pump with MULTI V Water and variable water flow control kit
- 2) Constant pump (Step control) with Water cooled VRF

10 years energy cost (\$)

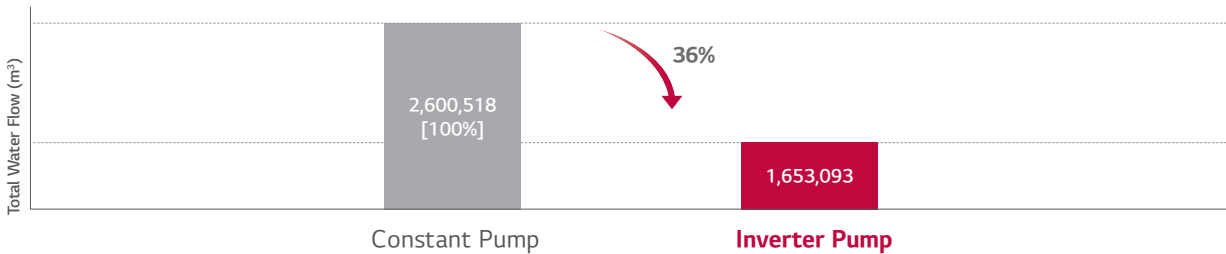

Unit	5 years		10 years	
	Energy Use (kWh)	Pump Running Cost (\$)	Energy Use (kWh)	Pump Running Cost (\$)
Constant pump	7,952,040	1,142,441	15,904,080	2,600,518
Inverter pump	5,054,940	726,225	10,109,880	1,653,093

※ Inverter Pump vs. Constant Pump

- Power consumption rate : 0.13\$/kWh
- Annual power consumption rate expected to increase by 5%

Nomenclature

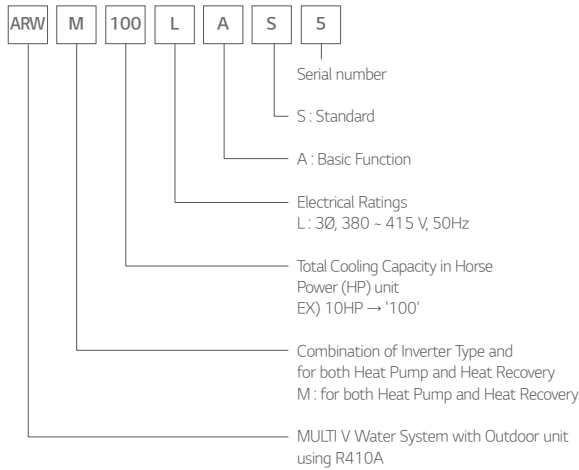

Outdoor Units Function

Category	Functions	Multi V Water 5
Key Refrigerant Components	HiPOR™ (High Pressure Oil Return)	○
	Oil Sensor	○
Reliability	High Pressure Switch	○
	Phase Protection	○
	Restart Delay (3-minutes)	○
	Self Diagnosis	○
	Soft Start	○
Central Controller	AC Ez	PQCSZ250S0
	AC Ez Touch	PACEZA000
	AC Smart IV	PACS4B000
	AC Smart 5	PACS5A000
	ACP IV	PACP4B000
	ACP 5	PACP5A000
	AC Manager IV	PACM4B000
Gateway	AC Manager 5	PACM5A000
	ACP BACnet	PQNF17C0
	ACP5 (w U60FT)	○
	Cloud Gateway	PWFMD200
	Modbus RTU	PMBUSB00A
	IO Module	PVDSMN000
	Variable Water Flow Control Kit	PWFCKN000
	Cool / Heat Selector	PRDSMB
	AHU comm. Kit	PAHCMR000
	AHU Controller Module	PAHCMS000
Intergration Device	AHU Control Kit	PAHCMC000
		PAHCMM000
		PAHCNM000
		PRLK048A0
	EEV Kit	PRLK096A0
		PRLK396A0
		PRLK594A0
	Water comm. Module	-
	PDI Standard	PPWRDB000
	PDI Premium	PQNUD1S40
ETC	DS (Data Saving) Module	PVADTN000

※ ○ : Applied, - : Not Applied

Operation Limits

Cooling

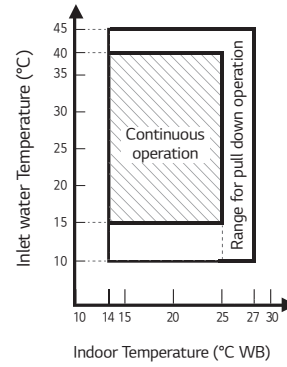

Heating

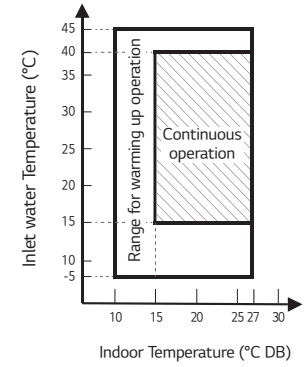

Note

- These figures assume the following operating conditions:
: Equivalent piping length is standard condition, and level difference is 0m.
- Range of pull down operation
: If the relative humidity is too high, cooling capacity can be decreased by the sensible heat reduction.
- Warming up operation means that the outdoor (outside) unit operates to reach the range of continuous operating, however it may not operate continuously due to safety or protection logic.

Position of Sound Pressure Level Measuring

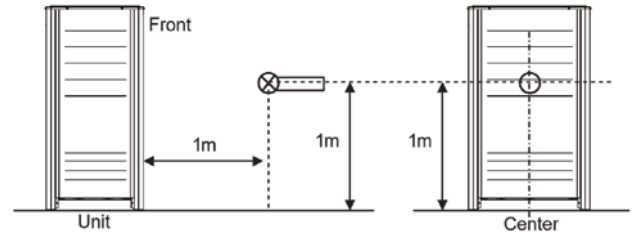

※ External Appearance of unit could be different by each model.

Note

- Data is valid at diffuse field condition.
- Data is valid at nominal operating condition.
- Reference acoustic pressure 0 dB = 20μPa.
- Sound pressure level is measured on the rated condition in the anechoic rooms by ISO 3745 standard. Refer to the model specifications for nominal conditions. (Power source and Ambient temperature, etc)
- Sound levels can be increased in accordance with installation and operating conditions. (Operating conditions include some functional condition like: Static pressure mode, air guide use, Room target temperature setting, etc and these functions are different in accordance with each model.)
- Sound level will vary depending on a range of factors such as the construction (acoustic absorption coefficient) of particular room in which the equipment is installed.

Optional Accessories

No.	Name	Model
1	Y branch pipe	ARLB01621
		for Heat Recovery
		ARLB03321
		ARLB07121
		ARBLB14521
	Header	for Heat Pump
		ARBLN01621
		ARBLN03321
		ARBLN07121
		ARBLN14521
2	4 branch	ARBL054
	7 branch	ARBL057
	4 branch	ARBL104
	7 branch	ARBL107
	10 branch	ARBL1010
	10 branch	ARBL2010
3	Connection pipe of Outdoor Units	ARCNN21
		ARCNN31

Dimensions

ARWM080LAS5 / ARWM100LAS5 / ARWM120LAS5 /
ARWM140LAS5 / ARWM160LAS5 / ARWM180LAS5 /
ARWM200LAS5

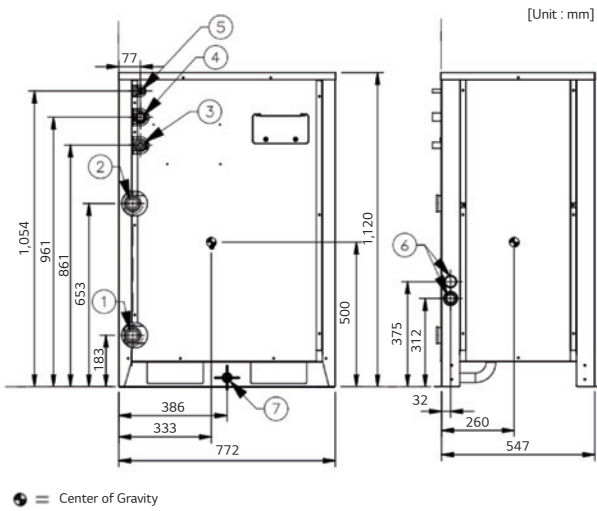

No.	Part Name	Description
1	Water inlet connection	PT 40 Female
2	Water outlet connection	PT 40 Female
3	High pressure pipe connection	-
4	Low pressure pipe connection	-
5	Liquid pipe connection	-
6	Power and comm. cable hole	-
7	Condensate drain pipe connection	PT 20 Male

Individual Installation

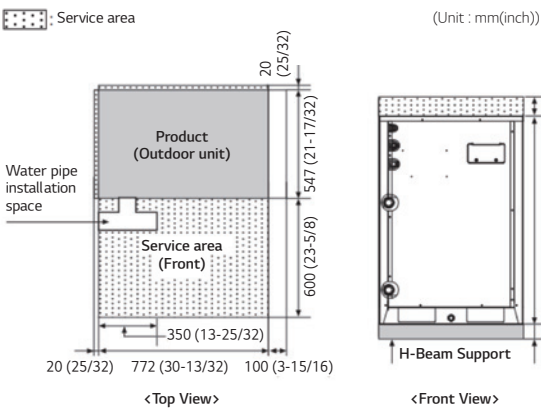

Water Piping Installation

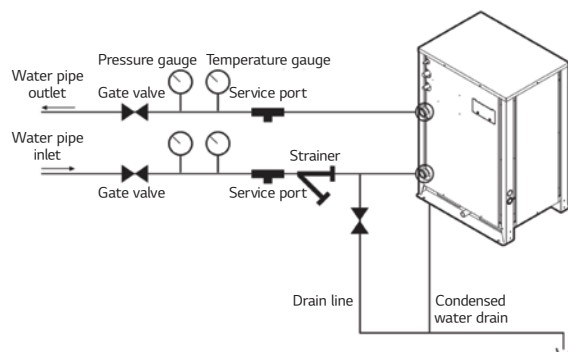

Precaution of Installation

- Do not install the unit at the outdoors.
 - Otherwise it may cause fire, electric shock and trouble.
- Keep the water temperature between **10 ~ 45°C** Other it may cause the breakdown.
 - Standard water supply temperature is **30°C** for Cooling and **20°C** for heating.
- Establish an **anti-freeze plan** for the water supply when the product is stopped during the winter.
- Be careful of the **Water Purity Control**. Otherwise it may cause the breakdown due to water pipe corrosion. (Refer to 'Standard Table for Water Purity Control' in Installation manual.)
- The water pressure resistance of the water pipe system of this product is **1.98MPa**.
- Always install a **trap** so that the drained water does not back flush.
- Install a **pressure gauge and temperature gauge** at the inlet and outlet of the water pipe.
- Flexible joints** must be installed not to cause any leakage from the vibration of pipes.
- Install a **service port** to clean the heat exchanger at the each end of the water inlet and outlet.
- You must install the **flow switch** to the water collection pipe system connecting to the outdoor unit. (**Flow switch** acts as the 1st protection device when the heat water is not supplied. If a certain level of water does not flow after installing the **flow switch**, an error sign of CH 189 error will be displayed on the product and the product will stop operating.)
- When setting the flow switch, it is recommended to use the product with default set value to satisfy the minimum flow rate of this product. (The minimum flow rate range of this product is 50 %. Reference flow rate : 10 HP - 96 LPM, 20 HP - 192 LPM)
- To protect the water cooling type product, you must install a **strainer with 50 mesh** or more on the heat water supply pipe. (It is recommended to install both a magnetic filter and a strainer.) If not installed, it can result in damage of heat exchanger by the following situation.
 - Heat water supply within the plate type heat exchanger is composed of multiple small paths.
 - If you do not use a strainer with 50 mesh or more, alien particles can partially block the water paths.
 - When running the heater, the plate type heat exchanger plays the role of the evaporator, and at this time, the temperature of coolant side drops to drop the temperature of the heat water supply, which can result in icing point in the water paths.
 - And as the heating process progresses, the water paths can be partially frozen to lead to damage in plate type heat exchanger.
 - As a result of the damage of the heat exchanger from the freezing, the coolant side and the heat water source side will be mixed to make the product unusable.

Bouygues Challenger

LG MULTI V Water Solution with Geothermal Application.



Site Information

The industrial group Bouygues was established in France in 1952. It now maintains operations in 80 countries and employs more than 131,000 people. In 1988, after two years of construction, the new headquarters for Bouygues Construction was officially opened for business. Named Challenger, the complex became a technological showcase for late 20th century architecture.

LG Solution

Bouygues decided to convert their headquarters into an eco-conscious building by significantly reducing its energy footprint. The LG MULTI V Water system was chosen as the ideal HVAC solution for this project. The system not only saves energy but also reduces water usage as it recycles water in order to regulate the temperature of the building. With LG's advanced technology, the building's water consumption was reduced by more than 70 percent.

**ARWM080LAS5 / ARWM100LAS5
ARWM120LAS5**



HP		8	10	12
Model Name	Combination Unit	ARWM080LAS5	ARWM100LAS5	ARWM120LAS5
	Independent Unit (1)	ARWM080LAS5	ARWM100LAS5	ARWM120LAS5
	Independent Unit (2)	-	-	-
	Independent Unit (3)	-	-	-
	Independent Unit (4)	-	-	-
Capacity	Cooling (Rated) kW	22.4	28.0	33.6
	Heating (Rated) kW	25.2	31.5	37.8
Input	Cooling (Rated) kW	3.25	4.19	5.14
	Heating (Rated) kW	3.50	4.57	5.56
EER	Rated	6.90	6.68	6.54
	Rated	7.20	6.90	6.80
Exterior	Color	Morning Gray / Dawn Gray	Morning Gray / Dawn Gray	Morning Gray / Dawn Gray
	RAL (Classic)	RAL 7038 / RAL 7037	RAL 7038 / RAL 7037	RAL 7038 / RAL 7037
Heat Exchanger	Type	Stainless Steel Plate	Stainless Steel Plate	Stainless Steel Plate
	Maximum Pressure Resistance kgf/cm ²	45	45	45
	Head Loss kPa	10.6	15.9	22.1
	Rated Water Flow LPM	77	96	115
Compressor	Type	Hermetically Sealed Scroll	Hermetically Sealed Scroll	Hermetically Sealed Scroll
	Combination x No.	(Inverter) x 1	(Inverter) x 1	(Inverter) x 1
	Motor Output x Number W x No.	5,300 x 1	5,300 x 1	5,300 x 1
	Oil Type	FVC68D (PVE)	FW68D (PVE)	FW68D (PVE)
Refrigerant Connecting Pipes	Liquid Pipe mm (inch)	Ø9.52 (3/8)	Ø9.52 (3/8)	Ø12.7 (1/2)
	Gas Pipe mm (inch)	Ø19.05 (3/4)	Ø22.22 (7/8)	Ø28.58 (1-1/8)
Water Connecting Pipes	Inlet mm	PT 40 (Internal Thread)	PT 40 (Internal Thread)	PT 40 (Internal Thread)
	Outlet mm	PT 40 (Internal Thread)	PT 40 (Internal Thread)	PT 40 (Internal Thread)
	Drain Outlet mm	PT 20 (External Thread)	PT 20 (External Thread)	PT 20 (External Thread)
Dimensions (W x H x D) - Net	mm	772 x 1,120 x 547	772 x 1,120 x 547	772 x 1,120 x 547
Dimensions (W x H x D) - Shipping	mm	820 x 1,245 x 645	820 x 1,245 x 645	820 x 1,245 x 645
Net Weight	kg	149 x 1	149 x 1	149 x 1
Shipping Weight	kg	157 x 1	157 x 1	157 x 1
Sound Pressure Level	Cooling / Heating dB(A)	45.0 / 48.0	48.0 / 48.0	48.0 / 51.0
Sound Power Level	Cooling / Heating dB(A)	57.0 / 60.0	60.0 / 60.0	60.0 / 63.0
Communication Cable	mm ² x No. (VCTF-SB)	1.0 - 1.5 x 2C	1.0 - 1.5 x 2C	1.0 - 1.5 x 2C
Refrigerant	Refrigerant Name	-	R410A	R410A
	Precharged Amount in Factory kg	-	3.5	3.5
	t-CO ₂ eq	-	7.306	7.306
	Control	-	Electronic expansion valve	Electronic expansion valve
Power Supply	Ø, V, Hz	3, 380-415, 50	3, 380-415, 50	3, 380-415, 50
Number of Maximum Connectable Indoor Units		13 (20)	16 (25)	20 (30)

Note

- Maximum numbers are prepared based on assumption that all 2.2kW indoor units are connected. The numbers in parentheses means maximum connectable indoor units in accordance with outdoor units combination (160% - 200%). The recommended ratio is 130%.
- Due to our policy of innovation some specifications may be changed without notification
- Performances are based on the following conditions
 - Cooling : Indoor temp 27°C (80.6°F) DB / 19°C (66.2°F) WB, Water inlet temp 30°C (86°F)
 - Heating : Indoor temp 20°C (68°F) DB, Water inlet temp 20°C (68°F)
 - Interconnected Pipe Length is 7.5m and difference of Elevation (Outdoor - Indoor Unit) is 0m.
- Sound pressure level is measured on the rated condition in the anechoic rooms by ISO 3745 standard.
Sound power level is measured on the rated condition in the reverberation rooms by ISO 3741 standard.
Therefore, these values can be increased owing to ambient conditions during operation.
- This product contains Fluorinated Greenhouse Gases. (R410A, GWP (Global warming potential) = 2,087.5)
- Add an anti freeze to circulation water when outdoor unit is operating under 10°C (50°F), and change the DIP switch on main PCB. (For more information on installation section.)

**ARWM140LAS5 / ARWM160LAS5
ARWM180LAS5**



HP			14	16	18
Model Name	Combination Unit		ARWM140LAS5	ARWM160LAS5	ARWM180LAS5
	Independent Unit (1)		ARWM140LAS5	ARWM160LAS5	ARWM180LAS5
	Independent Unit (2)		-	-	-
	Independent Unit (3)		-	-	-
	Independent Unit (4)		-	-	-
Capacity	Cooling (Rated)	kW	39.2	44.8	50.4
	Heating (Rated)	kW	44.1	50.4	56.7
Input	Cooling (Rated)	kW	6.22	7.32	8.40
	Heating (Rated)	kW	6.78	8.06	8.72
EER	Rated		6.30	6.12	6.00
COP	Rated		6.50	6.25	6.50
Exterior	Color		Morning Gray / Dawn Gray	Morning Gray / Dawn Gray	Morning Gray / Dawn Gray
	RAL (Classic)		RAL 7038 / RAL 7037	RAL 7038 / RAL 7037	RAL 7038 / RAL 7037
Heat Exchanger	Type		Stainless Steel Plate	Stainless Steel Plate	Stainless Steel Plate
	Maximum Pressure Resistance	kgf/cm ²	45	45	45
	Head Loss	kPa	29.6	37.7	24.6
	Rated Water Flow	LPM	135	154	173
Compressor	Type		Hermetically Sealed Scroll	Hermetically Sealed Scroll	Hermetically Sealed Scroll
	Combination x No.		(Inverter) x 1	(Inverter) x 1	(Inverter) x 1
	Motor Output x Number	W x No.	5,300 x 1	5,300 x 1	5,300 x 1
	Oil Type		FW68D (PVE)	FW68D (PVE)	FW68D (PVE)
	Oil Charge	cc	3,400	3,400	3,400
Refrigerant Connecting Pipes	Liquid Pipe	mm (inch)	Ø12.7 (1/2)	Ø12.7 (1/2)	Ø15.88 (5/8)
	Gas Pipe	mm (inch)	Ø28.58 (1-1/8)	Ø28.58 (1-1/8)	Ø28.58 (1-1/8)
Water Connecting Pipes	Inlet	mm	PT 40 (Internal Thread)	PT 40 (Internal Thread)	PT 40 (Internal Thread)
	Outlet	mm	PT 40 (Internal Thread)	PT 40 (Internal Thread)	PT 40 (Internal Thread)
	Drain Outlet	mm	PT 20 (External Thread)	PT 20 (External Thread)	PT 20 (External Thread)
Dimensions (W x H x D) - Net		mm	772 x 1,120 x 547	772 x 1,120 x 547	772 x 1,120 x 547
Dimensions (W x H x D) - Shipping		mm	820 x 1,245 x 645	820 x 1,245 x 645	820 x 1,245 x 645
Net Weight		kg	149 x 1	149 x 1	158 x 1
Shipping Weight		kg	157 x 1	157 x 1	166 x 1
Sound Pressure Level	Cooling / Heating	dB(A)	52.0 / 53.0	52.0 / 56.0	54.0 / 57.0
Sound Power Level	Cooling / Heating	dB(A)	64.0 / 65.0	64.0 / 68.0	66.0 / 69.0
Communication Cable		mm ² x No. (VCTF-SB)	1.0 - 1.5 x 2C	1.0 - 1.5 x 2C	1.0 - 1.5 x 2C
Refrigerant	Refrigerant Name		-	R410A	R410A
	Precharged Amount in Factory	kg	3.5	3.5	4.5
	t-CO ₂ eq	-	7.306	7.306	9.394
	Control		-	Electronic expansion valve	Electronic expansion valve
Power Supply		Ø, V, Hz	3, 380-415, 50	3, 380-415, 50	3, 380-415, 50
Number of Maximum Connectable Indoor Units			23 (35)	26 (40)	29 (45)

Note

- Maximum numbers are prepared based on assumption that all 2.2kW indoor units are connected. The numbers in parentheses means maximum connectable indoor units in accordance with outdoor units combination (160% - 200%). The recommended ratio is 130%.
- Due to our policy of innovation some specifications may be changed without notification
- Performances are based on the following conditions
 - Cooling : Indoor temp 27°C (80.6°F) DB / 19°C (66.2°F) WB, Water inlet temp 30°C (86°F)
 - Heating : Indoor temp 20°C (68°F) DB, Water inlet temp 20°C (68°F)
 - Interconnected Pipe Length is 7.5m and difference of Elevation (Outdoor - Indoor Unit) is 0m.
- Sound pressure level is measured on the rated condition in the anechoic rooms by ISO 3745 standard.
Sound power level is measured on the rated condition in the reverberation rooms by ISO 3741 standard.
Therefore, these values can be increased owing to ambient conditions during operation.
- This product contains Fluorinated Greenhouse Gases. (R410A, GWP (Global warming potential) = 2,087.5)
- Add an anti freeze to circulation water when outdoor unit is operating under 10°C (50°F), and change the DIP switch on main PCB. (For more information on installation section.)

ARWM200LAS5

ARWM220LAS5
ARWM240LAS5

HP		20	22	24
Model Name	Combination Unit	ARWM200LAS5	ARWM220LAS5	ARWM240LAS5
	Independent Unit (1)	ARWM200LAS5	ARWM120LAS5	ARWM120LAS5
	Independent Unit (2)	-	ARWM100LAS5	ARWM120LAS5
	Independent Unit (3)	-	-	-
	Independent Unit (4)	-	-	-
Capacity	Cooling (Rated) kW	56.0	61.6	67.2
	Heating (Rated) kW	63.0	69.3	75.6
Input	Cooling (Rated) kW	10.69	9.33	10.28
	Heating (Rated) kW	11.05	10.13	11.12
EER	Rated	5.24	6.60	6.54
	Rated	5.70	6.84	6.80
Exterior	Color	Morning Gray / Dawn Gray	Morning Gray / Dawn Gray	Morning Gray / Dawn Gray
	RAL (Classic)	RAL 7038 / RAL 7037	RAL 7038 / RAL 7037	RAL 7038 / RAL 7037
Heat Exchanger	Type	Stainless Steel Plate	Stainless Steel Plate	Stainless Steel Plate
	Maximum Pressure Resistance kgf/cm ²	45	45	45
	Head Loss kPa	29.9	22.1 + 15.9	22.1 + 22.1
	Rated Water Flow LPM	192	115 + 96	115 + 115
Compressor	Type	Hermetically Sealed Scroll	Hermetically Sealed Scroll	Hermetically Sealed Scroll
	Combination x No.	(Inverter) x 1	(Inverter) x 2	(Inverter) x 2
	Motor Output x Number W x No.	5,300 x 1	5,300 x 2	5,300 x 2
	Oil Type	FW68D (PVE)	FW68D (PVE)	FW68D (PVE)
Refrigerant Connecting Pipes	Oil Charge cc	3,400	6,800	6,800
	Liquid Pipe mm (inch)	Ø15.88 (5/8)	Ø15.88 (5/8)	Ø15.88 (5/8)
Water Connecting Pipes	Gas Pipe mm (inch)	Ø28.58 (1-1/8)	Ø28.58 (1-1/8)	Ø34.9 (1-3/8)
	Inlet mm	PT 40 (Internal Thread)	PT 40 + PT 40 (Internal Thread)	PT 40 + PT 40 (Internal Thread)
	Outlet mm	PT 40 (Internal Thread)	PT 40 + PT 40 (Internal Thread)	PT 40 + PT 40 (Internal Thread)
Dimensions (W x H x D) - Net	Drain Outlet mm	PT 20 (External Thread)	PT 20 (External Thread)	PT 20 (External Thread)
	mm	772 x 1,120 x 547	(772 x 1,120 x 547) x 2	(772 x 1,120 x 547) x 2
Dimensions (W x H x D) - Shipping	mm	820 x 1,245 x 645	(820 x 1,245 x 645) x 2	(820 x 1,245 x 645) x 2
	Net Weight kg	158 x 1	149 x 2	149 x 2
Shipping Weight kg	kg	166 x 1	157 x 2	157 x 2
	Sound Pressure Level Cooling / Heating dB(A)	55.0 / 56.0	51.0 / 53.0	51.0 / 54.0
Sound Power Level Cooling / Heating dB(A)	dB(A)	67.0 / 68.0	64.0 / 66.0	64.0 / 67.0
	Communication Cable mm ² x No. (VCTF-SB)	1.0 - 1.5 x 2C	1.0 - 1.5 x 2C	1.0 - 1.5 x 2C
Refrigerant	Refrigerant Name	-	R410A	R410A
	Precharged Amount in Factory kg	4.5	3.5 + 3.5	3.5 + 3.5
	t-CO ₂ eq	9.394	14.613	14.613
	Control	-	Electronic expansion valve	Electronic expansion valve
Power Supply	Ø, V, Hz	3, 380-415, 50	3, 380-415, 50	3, 380-415, 50
Number of Maximum Connectable Indoor Units		32 (50)	35 (44)	39 (48)

Note

- Maximum numbers are prepared based on assumption that all 2.2kW indoor units are connected. The numbers in parentheses means maximum connectable indoor units in accordance with outdoor units combination (160% - 200%). The recommended ratio is 1:30%.
- Due to our policy of innovation some specifications may be changed without notification.
- Performances are based on the following conditions:
 - Cooling : Indoor temp 27°C (80.6°F) DB / 19°C (66.2°F) WB, Water inlet temp 30°C (86°F)
 - Heating : Indoor temp 20°C (68°F) DB, Water inlet temp 20°C (68°F)
 - Interconnected Pipe Length is 7.5m and difference of Elevation (Outdoor - Indoor Unit) is 0m.
- Sound pressure level is measured on the rated condition in the anechoic rooms by ISO 3745 standard.
Sound power level is measured on the rated condition in the reverberation rooms by ISO 3741 standard.
Therefore, these values can be increased owing to ambient conditions during operation.
- This product contains Fluorinated Greenhouse Gases. (R410A, GWP (Global warming potential) = 2,087.5)
- Add an anti freeze to circulation water when outdoor unit is operating under 10°C (50°F), and change the DIP switch on main PCB. (For more information on installation section.)

**ARWM260LAS5 / ARWM280LAS5
ARWM300LAS5**



HP			26	28	30
Model Name	Combination Unit		ARWM260LAS5	ARWM280LAS5	ARWM300LAS5
	Independent Unit (1)		ARWM140LAS5	ARWM160LAS5	ARWM180LAS5
	Independent Unit (2)		ARWM120LAS5	ARWM120LAS5	ARWM120LAS5
	Independent Unit (3)		-	-	-
	Independent Unit (4)		-	-	-
Capacity	Cooling (Rated)	kW	72.8	78.4	84.0
	Heating (Rated)	kW	81.9	88.2	94.5
Input	Cooling (Rated)	kW	11.36	12.46	13.54
	Heating (Rated)	kW	12.34	13.62	14.28
EER	Rated		6.41	6.29	6.20
COP	Rated		6.64	6.48	6.62
Exterior	Color		Morning Gray / Dawn Gray	Morning Gray / Dawn Gray	Morning Gray / Dawn Gray
	RAL (Classic)		RAL 7038 / RAL 7037	RAL 7038 / RAL 7037	RAL 7038 / RAL 7037
Heat Exchanger	Type		Stainless Steel Plate	Stainless Steel Plate	Stainless Steel Plate
	Maximum Pressure Resistance	kgf/cm ²	45	45	45
	Head Loss	kPa	29.6 + 22.1	37.7 + 22.1	24.6 + 22.1
	Rated Water Flow	LPM	135 + 115	154 + 115	173 + 115
Compressor	Type		Hermetically Sealed Scroll	Hermetically Sealed Scroll	Hermetically Sealed Scroll
	Combination x No.		(Inverter) x 2	(Inverter) x 2	(Inverter) x 2
	Motor Output x Number	W x No.	5.300 x 2	5.300 x 2	5.300 x 2
	Oil Type		FW68D (PVE)	FW68D (PVE)	FW68D (PVE)
Refrigerant Connecting Pipes	Oil Charge	cc	6,800	6,800	6,800
	Liquid Pipe	mm (inch)	Ø19.05 (3/4)	Ø19.05 (3/4)	Ø19.05 (3/4)
Water Connecting Pipes	Gas Pipe	mm (inch)	Ø34.9 (1-3/8)	Ø34.9 (1-3/8)	Ø34.9 (1-3/8)
	Inlet	mm	PT 40 + PT 40 (Internal Thread)	PT 40 + PT 40 (Internal Thread)	PT 40 + PT 40 (Internal Thread)
	Outlet	mm	PT 40 + PT 40 (Internal Thread)	PT 40 + PT 40 (Internal Thread)	PT 40 + PT 40 (Internal Thread)
Dimensions (W x H x D) - Net	Drain Outlet	mm	PT 20 (External Thread)	PT 20 (External Thread)	PT 20 (External Thread)
			(772 x 1,120 x 547) x 2	(772 x 1,120 x 547) x 2	(772 x 1,120 x 547) x 2
Dimensions (W x H x D) - Shipping			(820 x 1,245 x 645) x 2	(820 x 1,245 x 645) x 2	(820 x 1,245 x 645) x 2
Net Weight		kg	149 x 2	149 x 2	(158 x 1) + (149 x 1)
Shipping Weight		kg	157 x 2	157 x 2	(166 x 1) + (157 x 1)
Sound Pressure Level	Cooling / Heating	dB(A)	53.0 / 55.0	53.0 / 57.0	55.0 / 58.0
Sound Power Level	Cooling / Heating	dB(A)	66.0 / 68.0	66.0 / 70.0	68.0 / 71.0
Communication Cable		mm ² x No. (VCTF-SB)	1.0 - 1.5 x 2C	1.0 - 1.5 x 2C	1.0 - 1.5 x 2C
Refrigerant	Refrigerant Name		R410A	R410A	R410A
	Precharged Amount in Factory	kg	3.5 + 3.5	3.5 + 3.5	4.5 + 3.5
	t-CO ₂ eq	-	14.613	14.613	16.700
	Control		-	Electronic expansion valve	Electronic expansion valve
Power Supply		Ø, V, Hz	3, 380-415, 50	3, 380-415, 50	3, 380-415, 50
Number of Maximum Connectable Indoor Units			42 (52)	45 (56)	49 (60)

Note

- Maximum numbers are prepared based on assumption that all 2.2kW indoor units are connected. The numbers in parentheses means maximum connectable indoor units in accordance with outdoor units combination (160% - 200%). The recommended ratio is 130%.
- Due to our policy of innovation some specifications may be changed without notification
- Performances are based on the following conditions
 - Cooling : Indoor temp 27°C (80.6°F) DB / 19°C (66.2°F) WB, Water inlet temp 30°C (86°F)
 - Heating : Indoor temp 20°C (68°F) DB, Water inlet temp 20°C (68°F)
 - Interconnected Pipe Length is 7.5m and difference of Elevation (Outdoor - Indoor Unit) is 0m.
- Sound pressure level is measured on the rated condition in the anechoic rooms by ISO 3745 standard.
Sound power level is measured on the rated condition in the reverberation rooms by ISO 3741 standard.
Therefore, these values can be increased owing to ambient conditions during operation.
- This product contains Fluorinated Greenhouse Gases. (R410A, GWP (Global warming potential) = 2,087.5)
- Add an anti freeze to circulation water when outdoor unit is operating under 10°C (50°F), and change the DIP switch on main PCB. (For more information on installation section.)

ARWM320LAS5 / ARWM340LAS5 ARWM360LAS5



HP		32	34	36
Model Name	Combination Unit	ARWM320LAS5	ARWM340LAS5	ARWM360LAS5
	Independent Unit (1)	ARWM200LAS5	ARWM200LAS5	ARWM200LAS5
	Independent Unit (2)	ARWM120LAS5	ARWM140LAS5	ARWM160LAS5
	Independent Unit (3)	-	-	-
	Independent Unit (4)	-	-	-
Capacity	Cooling (Rated) kW	89.6	95.2	100.8
	Heating (Rated) kW	100.8	107.1	113.4
Input	Cooling (Rated) kW	15.83	16.91	18.01
	Heating (Rated) kW	16.61	17.83	19.11
EER	Rated	5.66	5.63	5.60
COP	Rated	6.07	6.01	5.93
Exterior	Color	Morning Gray / Dawn Gray	Morning Gray / Dawn Gray	Morning Gray / Dawn Gray
	RAL (Classic)	RAL 7038 / RAL 7037	RAL 7038 / RAL 7037	RAL 7038 / RAL 7037
Heat Exchanger	Type	Stainless Steel Plate	Stainless Steel Plate	Stainless Steel Plate
	Maximum Pressure Resistance kgf/cm ²	45	45	45
	Head Loss kPa	29.9 + 22.1	29.9 + 29.6	29.9 + 37.7
	Rated Water Flow LPM	192 + 115	192 + 135	192 + 154
Compressor	Type	Hermetically Sealed Scroll	Hermetically Sealed Scroll	Hermetically Sealed Scroll
	Combination x No.	(Inverter) x 2	(Inverter) x 2	(Inverter) x 2
	Motor Output x Number W x No.	5,300 x 2	5,300 x 2	5,300 x 2
	Oil Type	FW68D (PVE)	FW68D (PVE)	FW68D (PVE)
	Oil Charge cc	6,800	6,800	6,800
Refrigerant Connecting Pipes	Liquid Pipe mm (inch)	Ø19.05 (3/4)	Ø19.05 (3/4)	Ø19.05 (3/4)
	Gas Pipe mm (inch)	Ø34.9 (1-3/8)	Ø34.9 (1-3/8)	Ø41.3 (1-5/8)
Water Connecting Pipes	Inlet mm	PT 40 + PT 40 (Internal Thread)	PT 40 + PT 40 (Internal Thread)	PT 40 + PT 40 (Internal Thread)
	Outlet mm	PT 40 + PT 40 (Internal Thread)	PT 40 + PT 40 (Internal Thread)	PT 40 + PT 40 (Internal Thread)
	Drain Outlet mm	PT 20 (External Thread)	PT 20 (External Thread)	PT 20 (External Thread)
Dimensions (W x H x D) - Net	mm	(772 x 1,120 x 547) x 2	(772 x 1,120 x 547) x 2	(772 x 1,120 x 547) x 2
Dimensions (W x H x D) - Shipping	mm	(820 x 1,245 x 645) x 2	(820 x 1,245 x 645) x 2	(820 x 1,245 x 645) x 2
Net Weight	kg	(158 x 1) + (149 x 1)	(158 x 1) + (149 x 1)	(158 x 1) + (149 x 1)
Shipping Weight	kg	(166 x 1) + (157 x 1)	(166 x 1) + (157 x 1)	(166 x 1) + (157 x 1)
Sound Pressure Level	Cooling / Heating dB(A)	56.0 / 57.0	57.0 / 58.0	57.0 / 59.0
Sound Power Level	Cooling / Heating dB(A)	69.0 / 70.0	70.0 / 71.0	70.0 / 72.0
Communication Cable	mm ² x No. (VCTF-SB)	1.0 - 1.5 x 2C	1.0 - 1.5 x 2C	1.0 - 1.5 x 2C
Refrigerant	Refrigerant Name	-	R410A	R410A
	Precharged Amount in Factory kg	-	4.5 + 3.5	4.5 + 3.5
	t-CO ₂ eq	-	16.700	16.700
	Control	-	Electronic expansion valve	Electronic expansion valve
Power Supply	Ø, V, Hz	3, 380-415, 50	3, 380-415, 50	3, 380-415, 50
Number of Maximum Connectable Indoor Units		52 (64)	55 (64)	58 (64)

Note

- Maximum numbers are prepared based on assumption that all 2.2kW indoor units are connected. The numbers in parentheses means maximum connectable indoor units in accordance with outdoor units combination (160% - 200%). The recommended ratio is 130%.
- Due to our policy of innovation some specifications may be changed without notification
- Performances are based on the following conditions
 - Cooling : Indoor temp 27°C (80.6°F) DB / 19°C (66.2°F) WB, Water inlet temp 30°C (86°F)
 - Heating : Indoor temp 20°C (68°F) DB, Water inlet temp 20°C (68°F)
 - Interconnected Pipe Length is 7.5m and difference of Elevation (Outdoor - Indoor Unit) is 0m.
- Sound pressure level is measured on the rated condition in the anechoic rooms by ISO 3745 standard.
Sound power level is measured on the rated condition in the reverberation rooms by ISO 3741 standard.
Therefore, these values can be increased owing to ambient conditions during operation.
- This product contains Fluorinated Greenhouse Gases. (R410A, GWP (Global warming potential) = 2,087.5)
- Add an anti freeze to circulation water when outdoor unit is operating under 10°C (50°F), and change the DIP switch on main PCB. (For more information on installation section.)

**ARWM380LAS5
ARWM400LAS5**



ARWM420LAS5



HP			38	40	42
Model Name	Combination Unit		ARWM380LAS5	ARWM400LAS5	ARWM420LAS5
	Independent Unit (1)		ARWM200LAS5	ARWM200LAS5	ARWM200LAS5
	Independent Unit (2)		ARWM180LAS5	ARWM200LAS5	ARWM140LAS5
	Independent Unit (3)		-	-	ARWM080LAS5
	Independent Unit (4)		-	-	-
Capacity	Cooling (Rated)	kW	106.4	112.0	117.6
	Heating (Rated)	kW	119.7	126.0	132.3
Input	Cooling (Rated)	kW	19.09	21.38	20.16
	Heating (Rated)	kW	19.77	22.10	21.33
EER	Rated		5.57	5.24	5.83
COP	Rated		6.05	5.70	6.20
Exterior	Color		Morning Gray / Dawn Gray	Morning Gray / Dawn Gray	Morning Gray / Dawn Gray
	RAL (Classic)		RAL 7038 / RAL 7037	RAL 7038 / RAL 7037	RAL 7038 / RAL 7037
Heat Exchanger	Type		Stainless Steel Plate	Stainless Steel Plate	Stainless Steel Plate
	Maximum Pressure Resistance	kgf/cm ²	45	45	45
	Head Loss	kPa	29.9 + 24.6	29.9 + 29.9	29.9 + 29.6 + 10.6
	Rated Water Flow	LPM	192 + 173	192 + 192	192 + 135 + 77
Compressor	Type		Hermetically Sealed Scroll	Hermetically Sealed Scroll	Hermetically Sealed Scroll
	Combination x No.		(Inverter) x 2	(Inverter) x 2	(Inverter) x 3
	Motor Output x Number	W x No.	5,300 x 2	5,300 x 2	5,300 x 3
	Oil Type		FW68D (PVE)	FW68D (PVE)	FW68D (PVE)
Refrigerant Connecting Pipes	Oil Charge	cc	6,800	6,800	10,200
	Liquid Pipe	mm (inch)	Ø19.05 (3/4)	Ø19.05 (3/4)	Ø19.05 (3/4)
Water Connecting Pipes	Gas Pipe	mm (inch)	Ø41.3 (1-5/8)	Ø41.3 (1-5/8)	Ø41.3 (1-5/8)
	Inlet	mm	PT 40 + PT 40 (Internal Thread)	PT 40 + PT 40 (Internal Thread)	PT 40 + PT 40 + PT 40 (Internal Thread)
	Outlet	mm	PT 40 + PT 40 (Internal Thread)	PT 40 + PT 40 (Internal Thread)	PT 40 + PT 40 + PT 40 (Internal Thread)
Dimensions (W x H x D) - Net	Drain Outlet	mm	PT 20 (External Thread)	PT 20 (External Thread)	PT 20 (External Thread)
			(772 x 1,120 x 547) x 2	(772 x 1,120 x 547) x 2	(772 x 1,120 x 547) x 3
Dimensions (W x H x D) - Shipping			(820 x 1,245 x 645) x 2	(820 x 1,245 x 645) x 2	(820 x 1,245 x 645) x 3
Net Weight		kg	158 x 2	158 x 2	(158 x 1) + (149 x 2)
Shipping Weight		kg	166 x 2	166 x 2	(166 x 1) + (157 x 2)
Sound Pressure Level	Cooling / Heating	dB(A)	58.0 / 60.0	58.0 / 59.0	57.0 / 58.0
Sound Power Level	Cooling / Heating	dB(A)	71.0 / 73.0	71.0 / 72.0	71.0 / 72.0
Communication Cable		mm ² x No. (VCTF-SB)	1.0 - 1.5 x 2C	1.0 - 1.5 x 2C	1.0 - 1.5 x 2C
Refrigerant	Refrigerant Name		R410A	R410A	R410A
	Precharged Amount in Factory	kg	4.5 + 4.5	4.5 + 4.5	4.5 + 3.5 + 3.5
	t-CO ₂ eq	-	18.788	18.788	24.006
	Control	-	Electronic expansion valve	Electronic expansion valve	Electronic expansion valve
Power Supply		Ø, V, Hz	3, 380-415, 50	3, 380-415, 50	3, 380-415, 50
Number of Maximum Connectable Indoor Units			61 (64)	64	64

Note

- Maximum numbers are prepared based on assumption that all 2.2kW indoor units are connected. The numbers in parentheses means maximum connectable indoor units in accordance with outdoor units combination (160% - 200%). The recommended ratio is 130%.
- Due to our policy of innovation some specifications may be changed without notification
- Performances are based on the following conditions
 - Cooling : Indoor temp 27°C (80.6°F) DB / 19°C (66.2°F) WB, Water inlet temp 30°C (86°F)
 - Heating : Indoor temp 20°C (68°F) DB, Water inlet temp 20°C (68°F)
 - Interconnected Pipe Length is 7.5m and difference of Elevation (Outdoor - Indoor Unit) is 0m.
- Sound pressure level is measured on the rated condition in the anechoic rooms by ISO 3745 standard.
Sound power level is measured on the rated condition in the reverberation rooms by ISO 3741 standard.
Therefore, these values can be increased owing to ambient conditions during operation.
- This product contains Fluorinated Greenhouse Gases. (R410A, GWP (Global warming potential) = 2,087.5)
- Add an anti freeze to circulation water when outdoor unit is operating under 10°C (50°F), and change the DIP switch on main PCB. (For more information on installation section.)

ARWM440LAS5 / ARWM460LAS5 ARWM480LAS5



HP		44	46	48
Model Name	Combination Unit	ARWM440LAS5	ARWM460LAS5	ARWM480LAS5
	Independent Unit (1)	ARWM200LAS5	ARWM200LAS5	ARWM200LAS5
	Independent Unit (2)	ARWM140LAS5	ARWM140LAS5	ARWM140LAS5
	Independent Unit (3)	ARWM100LAS5	ARWM120LAS5	ARWM140LAS5
	Independent Unit (4)	-	-	-
Capacity	Cooling (Rated) kW	123.2	128.8	134.4
	Heating (Rated) kW	138.6	144.9	151.2
Input	Cooling (Rated) kW	21.10	22.05	23.13
	Heating (Rated) kW	22.40	23.39	24.61
EER	Rated	5.84	5.84	5.81
COP	Rated	6.19	6.19	6.14
Exterior	Color	Morning Gray / Dawn Gray	Morning Gray / Dawn Gray	Morning Gray / Dawn Gray
	RAL (Classic)	RAL 7038 / RAL 7037	RAL 7038 / RAL 7037	RAL 7038 / RAL 7037
Heat Exchanger	Type	Stainless Steel Plate	Stainless Steel Plate	Stainless Steel Plate
	Maximum Pressure Resistance kgf/cm ²	45	45	45
	Head Loss kPa	29.9 + 29.6 + 15.9	29.9 + 29.6 + 22.1	29.9 + 29.6 + 29.6
	Rated Water Flow LPM	192 + 135 + 96	192 + 135 + 115	192 + 135 + 135
Compressor	Type	Hermetically Sealed Scroll	Hermetically Sealed Scroll	Hermetically Sealed Scroll
	Combination x No.	(Inverter) x 3	(Inverter) x 3	(Inverter) x 3
	Motor Output x Number W x No.	5,300 x 3	5,300 x 3	5,300 x 3
	Oil Type	FW68D (PVE)	FW68D (PVE)	FW68D (PVE)
	Oil Charge cc	10,200	10,200	10,200
Refrigerant Connecting Pipes	Liquid Pipe mm (inch)	Ø19.05 (3/4)	Ø19.05 (3/4)	Ø19.05 (3/4)
	Gas Pipe mm (inch)	Ø41.3 (1-5/8)	Ø41.3 (1-5/8)	Ø41.3 (1-5/8)
Water Connecting Pipes	Inlet mm	PT 40 + PT 40 + PT 40 (Internal Thread)	PT 40 + PT 40 + PT 40 (Internal Thread)	PT 40 + PT 40 + PT 40 (Internal Thread)
	Outlet mm	PT 40 + PT 40 + PT 40 (Internal Thread)	PT 40 + PT 40 + PT 40 (Internal Thread)	PT 40 + PT 40 + PT 40 (Internal Thread)
	Drain Outlet mm	PT 20 (External Thread)	PT 20 (External Thread)	PT 20 (External Thread)
Dimensions (W x H x D) - Net	mm	(772 x 1,120 x 547) x 3	(772 x 1,120 x 547) x 3	(772 x 1,120 x 547) x 3
Dimensions (W x H x D) - Shipping	mm	(820 x 1,245 x 645) x 3	(820 x 1,245 x 645) x 3	(820 x 1,245 x 645) x 3
Net Weight	kg	(158 x 1) + (149 x 2)	(158 x 1) + (149 x 2)	(158 x 1) + (149 x 2)
Shipping Weight	kg	(166 x 1) + (157 x 2)	(166 x 1) + (157 x 2)	(166 x 1) + (157 x 2)
Sound Pressure Level	Cooling / Heating dB(A)	57.0 / 58.0	57.0 / 59.0	58.0 / 59.0
Sound Power Level	Cooling / Heating dB(A)	71.0 / 72.0	71.0 / 73.0	72.0 / 73.0
Communication Cable	mm ² x No. (VCTF-SB)	1.0 - 1.5 x 2C	1.0 - 1.5 x 2C	1.0 - 1.5 x 2C
Refrigerant	Refrigerant Name	-	R410A	R410A
	Precharged Amount in Factory kg	-	4.5 + 3.5 + 3.5	4.5 + 3.5 + 3.5
	t-CO ₂ eq	-	24.006	24.006
	Control	-	Electronic expansion valve	Electronic expansion valve
Power Supply	Ø, V, Hz	3, 380-415, 50	3, 380-415, 50	3, 380-415, 50
Number of Maximum Connectable Indoor Units		64	64	64

Note

- Maximum numbers are prepared based on assumption that all 2.2kW indoor units are connected. The numbers in parentheses means maximum connectable indoor units in accordance with outdoor units combination (160% - 200%). The recommended ratio is 130%.
- Due to our policy of innovation some specifications may be changed without notification
- Performances are based on the following conditions
 - Cooling : Indoor temp 27°C (80.6°F) DB / 19°C (66.2°F) WB, Water inlet temp 30°C (86°F)
 - Heating : Indoor temp 20°C (68°F) DB, Water inlet temp 20°C (68°F)
 - Interconnected Pipe Length is 7.5m and difference of Elevation (Outdoor - Indoor Unit) is 0m.
- Sound pressure level is measured on the rated condition in the anechoic rooms by ISO 3745 standard.
Sound power level is measured on the rated condition in the reverberation rooms by ISO 3741 standard.
Therefore, these values can be increased owing to ambient conditions during operation.
- This product contains Fluorinated Greenhouse Gases. (R410A, GWP (Global warming potential) = 2,087.5)
- Add an anti freeze to circulation water when outdoor unit is operating under 10°C (50°F), and change the DIP switch on main PCB. (For more information on installation section.)

**ARWM500LAS5 / ARWM520LAS5
ARWM540LAS5**



HP			50	52	54
Model Name	Combination Unit		ARWM500LAS5	ARWM520LAS5	ARWM540LAS5
	Independent Unit (1)		ARWM200LAS5	ARWM200LAS5	ARWM200LAS5
	Independent Unit (2)		ARWM200LAS5	ARWM200LAS5	ARWM200LAS5
	Independent Unit (3)		ARWM100LAS5	ARWM120LAS5	ARWM140LAS5
	Independent Unit (4)		-	-	-
Capacity	Cooling (Rated)	kW	140.0	145.6	151.2
	Heating (Rated)	kW	157.5	164	170.1
Input	Cooling (Rated)	kW	25.57	27	27.60
	Heating (Rated)	kW	26.67	27.66	28.88
EER	Rated		5.48	5.49	5.48
COP	Rated		5.91	5.92	5.89
Exterior	Color		Morning Gray / Dawn Gray	Morning Gray / Dawn Gray	Morning Gray / Dawn Gray
	RAL (Classic)		RAL 7038 / RAL 7037	RAL 7038 / RAL 7037	RAL 7038 / RAL 7037
Heat Exchanger	Type		Stainless Steel Plate	Stainless Steel Plate	Stainless Steel Plate
	Maximum Pressure Resistance	kgf/cm ²	45	45	45
	Head Loss	kPa	29.9 + 29.9 + 15.9	29.9 + 29.9 + 22.1	29.9 + 29.9 + 29.6
	Rated Water Flow	LPM	192 + 192 + 96	192 + 192 + 115	192 + 192 + 135
Compressor	Type		Hermetically Sealed Scroll	Hermetically Sealed Scroll	Hermetically Sealed Scroll
	Combination x No.		(Inverter) x 3	(Inverter) x 3	(Inverter) x 3
	Motor Output x Number	W x No.	5,300 x 3	5,300 x 3	5,300 x 3
	Oil Type		FW68D (PVE)	FW68D (PVE)	FW68D (PVE)
	Oil Charge	cc	10,200	10,200	10,200
Refrigerant Connecting Pipes	Liquid Pipe	mm (inch)	Ø19.05 (3/4)	Ø19.05 (3/4)	Ø19.05 (3/4)
	Gas Pipe	mm (inch)	Ø41.3 (1-5/8)	Ø41.3 (1-5/8)	Ø41.3 (1-5/8)
Water Connecting Pipes	Inlet	mm	PT 40 + PT 40 + PT 40 (Internal Thread)	PT 40 + PT 40 + PT 40 (Internal Thread)	PT 40 + PT 40 + PT 40 (Internal Thread)
	Outlet	mm	PT 40 + PT 40 + PT 40 (Internal Thread)	PT 40 + PT 40 + PT 40 (Internal Thread)	PT 40 + PT 40 + PT 40 (Internal Thread)
	Drain Outlet	mm	PT 20 (External Thread)	PT 20 (External Thread)	PT 20 (External Thread)
Dimensions (W x H x D) - Net		mm	(772 x 1,120 x 547) x 3	(772 x 1,120 x 547) x 3	(772 x 1,120 x 547) x 3
Dimensions (W x H x D) - Shipping		mm	(820 x 1,245 x 645) x 3	(820 x 1,245 x 645) x 3	(820 x 1,245 x 645) x 3
Net Weight		kg	(158 x 2) + (149 x 1)	(158 x 2) + (149 x 1)	(158 x 2) + (149 x 1)
Shipping Weight		kg	(166 x 2) + (157 x 1)	(166 x 2) + (157 x 1)	(166 x 2) + (157 x 1)
Sound Pressure Level	Cooling / Heating	dB(A)	59.0 / 59.0	59.0 / 60.0	59.0 / 60.0
Sound Power Level	Cooling / Heating	dB(A)	73.0 / 73.0	73.0 / 74.0	73.0 / 74.0
Communication Cable		mm ² x No. (VCTF-SB)	1.0 - 1.5 x 2C	1.0 - 1.5 x 2C	1.0 - 1.5 x 2C
Refrigerant	Refrigerant Name		-	R410A	R410A
	Precharged Amount in Factory	kg	4.5 + 4.5 + 3.5	4.5 + 4.5 + 3.5	4.5 + 4.5 + 3.5
	t-CO ₂ eq	-	26.094	26.094	26.094
	Control		-	Electronic expansion valve	Electronic expansion valve
Power Supply		Ø, V, Hz	3, 380-415, 50	3, 380-415, 50	3, 380-415, 50
Number of Maximum Connectable Indoor Units			64	64	64

Note

- Maximum numbers are prepared based on assumption that all 2.2kW indoor units are connected. The numbers in parentheses means maximum connectable indoor units in accordance with outdoor units combination (160% - 200%). The recommended ratio is 130%.
- Due to our policy of innovation some specifications may be changed without notification
- Performances are based on the following conditions
 - Cooling : Indoor temp 27°C (80.6°F) DB / 19°C (66.2°F) WB, Water inlet temp 30°C (86°F)
 - Heating : Indoor temp 20°C (68°F) DB, Water inlet temp 20°C (68°F)
 - Interconnected Pipe Length is 7.5m and difference of Elevation (Outdoor - Indoor Unit) is 0m.
- Sound pressure level is measured on the rated condition in the anechoic rooms by ISO 3745 standard.
Sound power level is measured on the rated condition in the reverberation rooms by ISO 3741 standard.
Therefore, these values can be increased owing to ambient conditions during operation.
- This product contains Fluorinated Greenhouse Gases. (R410A, GWP (Global warming potential) = 2,087.5)
- Add an anti freeze to circulation water when outdoor unit is operating under 10°C (50°F), and change the DIP switch on main PCB. (For more information on installation section.)

ARWM560LAS5 / ARWM580LAS5 ARWM600LAS5



HP		56	58	60
Model Name	Combination Unit	ARWM560LAS5	ARWM580LAS5	ARWM600LAS5
	Independent Unit (1)	ARWM200LAS5	ARWM200LAS5	ARWM200LAS5
	Independent Unit (2)	ARWM200LAS5	ARWM200LAS5	ARWM200LAS5
	Independent Unit (3)	ARWM160LAS5	ARWM180LAS5	ARWM200LAS5
	Independent Unit (4)	-	-	-
Capacity	Cooling (Rated) kW	156.8	162.4	168.0
	Heating (Rated) kW	176.4	182.7	189.0
Input	Cooling (Rated) kW	28.70	29.78	32.07
	Heating (Rated) kW	30.16	30.82	33.15
EER	Rated	5.46	5.45	5.24
	Rated	5.85	5.93	5.70
Exterior	Color	Morning Gray / Dawn Gray	Morning Gray / Dawn Gray	Morning Gray / Dawn Gray
	RAL (Classic)	RAL 7038 / RAL 7037	RAL 7038 / RAL 7037	RAL 7038 / RAL 7037
Heat Exchanger	Type	Stainless Steel Plate	Stainless Steel Plate	Stainless Steel Plate
	Maximum Pressure Resistance kgf/cm ²	45	45	45
	Head Loss kPa	29.9 + 29.9 + 37.7	29.9 + 29.9 + 24.6	29.9 + 29.9 + 29.9
	Rated Water Flow LPM	192 + 192 + 154	192 + 192 + 173	192 + 192 + 192
Compressor	Type	Hermetically Sealed Scroll	Hermetically Sealed Scroll	Hermetically Sealed Scroll
	Combination x No.	(Inverter) x 3	(Inverter) x 3	(Inverter) x 3
	Motor Output x Number W x No.	5,300 x 3	5,300 x 3	5,300 x 3
	Oil Type	FW68D (PVE)	FW68D (PVE)	FW68D (PVE)
Refrigerant Connecting Pipes	Oil Charge cc	10,200	10,200	10,200
	Liquid Pipe mm (inch)	Ø19.05 (3/4)	Ø19.05 (3/4)	Ø19.05 (3/4)
Water Connecting Pipes	Gas Pipe mm (inch)	Ø41.3 (1-5/8)	Ø41.3 (1-5/8)	Ø41.3 (1-5/8)
	Inlet mm	PT 40 + PT 40 + PT 40 (Internal Thread)	PT 40 + PT 40 + PT 40 (Internal Thread)	PT 40 + PT 40 + PT 40 (Internal Thread)
	Outlet mm	PT 40 + PT 40 + PT 40 (Internal Thread)	PT 40 + PT 40 + PT 40 (Internal Thread)	PT 40 + PT 40 + PT 40 (Internal Thread)
Dimensions (W x H x D) - Net	Drain Outlet mm	PT 20 (External Thread)	PT 20 (External Thread)	PT 20 (External Thread)
	mm	(772 x 1,120 x 547) x 3	(772 x 1,120 x 547) x 3	(772 x 1,120 x 547) x 3
Dimensions (W x H x D) - Shipping	mm	(820 x 1,245 x 645) x 3	(820 x 1,245 x 645) x 3	(820 x 1,245 x 645) x 3
	Net Weight kg	(158 x 2) + (149 x 1)	158 x 3	158 x 3
Shipping Weight	kg	(166 x 2) + (157 x 1)	166 x 3	166 x 3
	Sound Pressure Level Cooling / Heating dB(A)	59.0 / 61.0	60.0 / 61.0	60.0 / 61.0
Sound Power Level	Cooling / Heating dB(A)	73.0 / 75.0	74.0 / 75.0	74.0 / 75.0
	Communication Cable mm ² x No. (VCTF-SB)	1.0 - 1.5 x 2C	1.0 - 1.5 x 2C	1.0 - 1.5 x 2C
Refrigerant	Refrigerant Name	-	R410A	R410A
	Precharged Amount in Factory kg	-	4.5 + 4.5 + 3.5	4.5 + 4.5 + 4.5
	t-CO ₂ eq	-	26.094	28.181
	Control	-	Electronic expansion valve	Electronic expansion valve
Power Supply	Ø, V, Hz	3, 380-415, 50	3, 380-415, 50	3, 380-415, 50
Number of Maximum Connectable Indoor Units		64	64	64

Note

- Maximum numbers are prepared based on assumption that all 2.2kW indoor units are connected. The numbers in parentheses means maximum connectable indoor units in accordance with outdoor units combination (160% - 200%). The recommended ratio is 130%.
- Due to our policy of innovation some specifications may be changed without notification
- Performances are based on the following conditions
 - Cooling : Indoor temp 27°C (80.6°F) DB / 19°C (66.2°F) WB, Water inlet temp 30°C (86°F)
 - Heating : Indoor temp 20°C (68°F) DB, Water inlet temp 20°C (68°F)
 - Interconnected Pipe Length is 7.5m and difference of Elevation (Outdoor - Indoor Unit) is 0m.
- Sound pressure level is measured on the rated condition in the anechoic rooms by ISO 3745 standard.
Sound power level is measured on the rated condition in the reverberation rooms by ISO 3741 standard.
Therefore, these values can be increased owing to ambient conditions during operation.
- This product contains Fluorinated Greenhouse Gases. (R410A, GWP (Global warming potential) = 2,087.5)
- Add an anti freeze to circulation water when outdoor unit is operating under 10°C (50°F), and change the DIP switch on main PCB. (For more information on installation section.)



INDOOR UNITS

114 ~ 189

WALL MOUNTED

CEILING MOUNTED CASSETTE

CEILING MOUNTED
ROUND CASSETTE

CEILING CONCEALED DUCT

FRESH AIR INTAKE

CEILING & FLOOR CONVERTIBLE
CEILING SUSPENDED

CONSOLE & FLOOR STANDING

FLOOR STANDING (PAC)

COMPATIBILITY &
FEATURE FUNCTIONS





Features & Benefits

- 6 Different discharge angles can be programmed via the remote controller.
- Easily detachable full surface cover helps to clean the air conditioner.
- Drain pipe can be easily hidden from sight.

Key Applications

- Retail
- Restaurant
- Office
- Hotel
- Multi-family Residence

WALL MOUNTED		ARTCOOL MIRROR	ARTCOOL GALLERY	STANDARD
Smart	Wi-Fi	○	○	○
Energy Efficiency	Energy Display	○	○	○
Fast Cooling & Heating	Jet Cool	○	○	○
	Auto Swing (Up & Down)	○	○	○
Health	Ionizer	○	-	○ -7.1kW Only
	Pre Filter	○	○	○
	Auto Cleaning	○	○	○
Comfort	Sleep Mode	○	○	○
	Timer (On / Off)	○	○	○
	Timer (Weekly)	○	○	○
	Two Thermistor Control	○	○	○
	Group Control	○	○	○

※ ○: Applied, - : Not applied

Wi-Fi Control

Anytime, anywhere access to the unit with Android & iOS-based smartphones.

ThinQ

Search "ThinQ" on Google market or the App Store to download the app.

Integrated Home Appliances Control

Control / Monitor all your LG appliances from one place.



Easy Registration and Log-in

Follow the easy set-up steps that will activate ThinQ's user-friendly features.

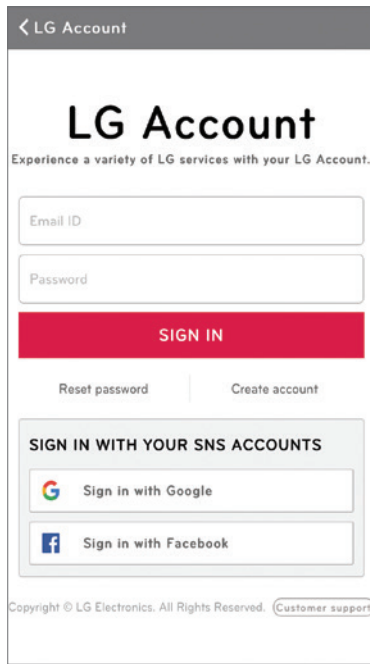

Simple operation for various functions



On / Off, Current Temp

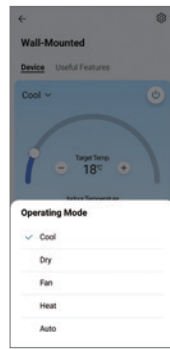

Mode, Set Temp



Vane Control

Straight forward Management



Energy Monitoring



Smart Diagnosis

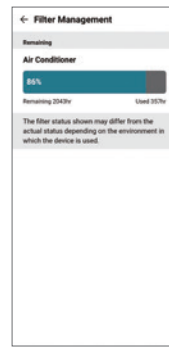

Filter Management

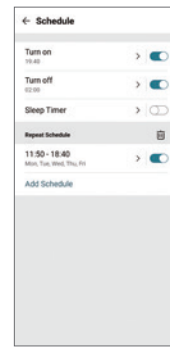

Reservation

※ For our policy of continuous ThinQ App improvement, specification, design and features are subject to change without prior notice.

Wi-Fi Control

Anytime, anywhere access to the unit with Android & iOS-based smartphones.

ThinQ

Search "ThinQ" on Google market or the App Store to download the app.

Access your air conditioner anytime and from anywhere with a Wi-Fi equipped device and LG's exclusive control app, ThinQ.



Wi-Fi Connectivity

Each user can set and save temperature and fan speed preferences in the ThinQ app. If a household has more than one indoor unit, separate temperature settings can be set for each.

Multiple Devices



※ Can be controlled by multiple users, but not simultaneously.

Multi-C ontrol



※ For our policy of continuous ThinQ App improvement, specification, design and features are subject to change without prior notice.

Ionizer^{PLUS}

The powerful Ionizer protects you from bad odors and Escherichia coli and Staphylococcus in the surface with over 8 million ions to reduce to make a safer, and cleaner environment.

※ Specifications may vary for each model.
 ※ Depending on the experimental conditions.

Reduction and Deodorization (Utilizes Over 8 Million Ions)

Ionizer+ reduces E.coli and Staphylococcus in the surface with over 8 million ions.

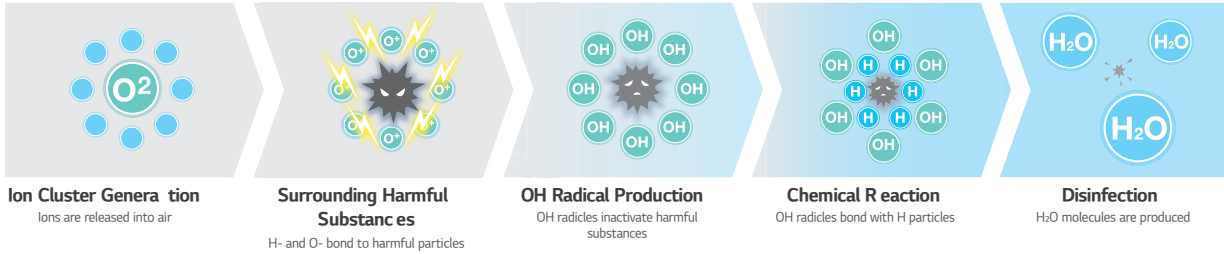

Reduction Performance Evaluations

Reduce Bacteria E.coli over 99.9% in 20 min. and staphylococcus over 99.9% in 60min.

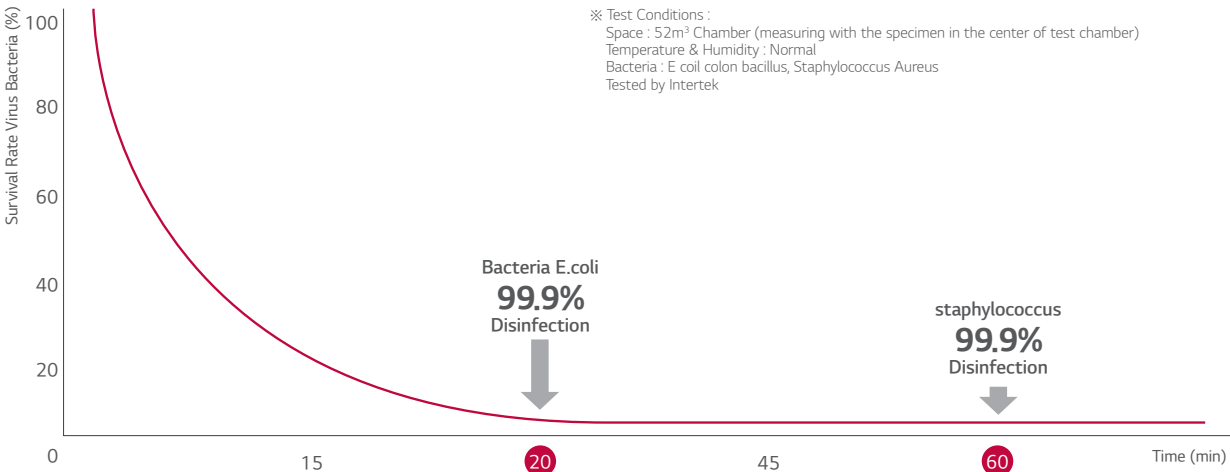

※ TÜV Rheinland's test in a 30 m³ room confirmed that the Plasmaster™ ionizer++ removes up to 99.9% of bacteria (Staphylococcus aureus, Escherichia coli and Pseudomonas aeruginosa) adhering to surfaces. The tested type was SW09BAJWAN. This does not actually mean the bacteria removal efficiency, the bacteria removal efficiency may differ depending on the actual conditions of use.

2.1 odor strength decrease in 60 minutes

An odor of measured as 2 European odor units (ouE/m³) or less indicates that the level of odor falls within permissible limits.

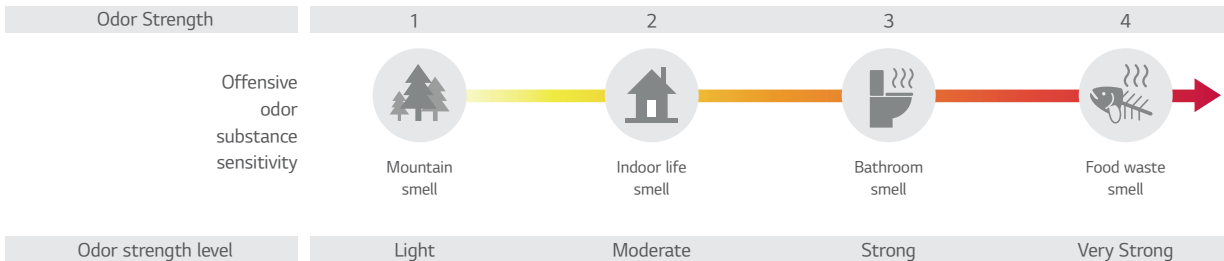

Odor strength reduce 3.6 → 1.5 / The Odor floating in the room as well as curtain and clothes.

※ Test conditions : Space: 8m³ Chamber
 Temperature & Humidity : Normal
 Tested by Intertek

Auto Cleaning

The unit has a self-cleaning function that dries the heat exchanger before cleaning the interior.

Pain Point

The main cause of odor within air conditioners is mold and bacteria growing on the heat exchanger. These germs can spread when the heat exchanger is wet.

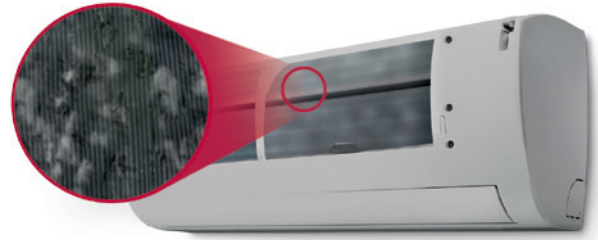

Cleans Filter with Regular Airflow

The comprehensive auto cleaning function prevents the formation of bacteria and mold on the heat exchanger.

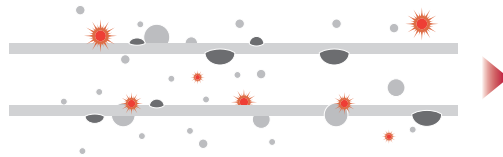

By dehumidifying, (Some models are by dehumidifying and ionizing), the auto cleaning function prevents potentially harmful substances from forming on the surface of the heat exchanger.

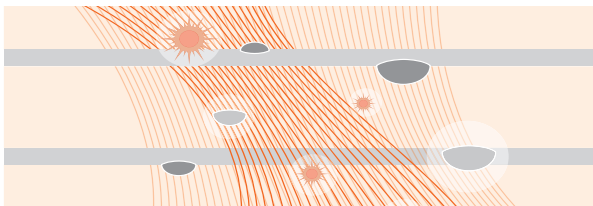

The indoor environment remains odorless with the advanced deodorizing function.

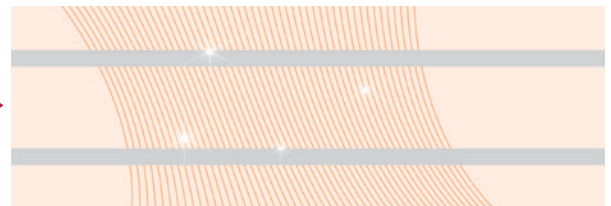

By preventing pollution of the heat exchanger caused by various germs and bacteria, performance and lifespan of the air conditioner can be increased by 10 years.

Installation Support Clip

A support clip creates adequate space between the wall and the unit for easier installation.

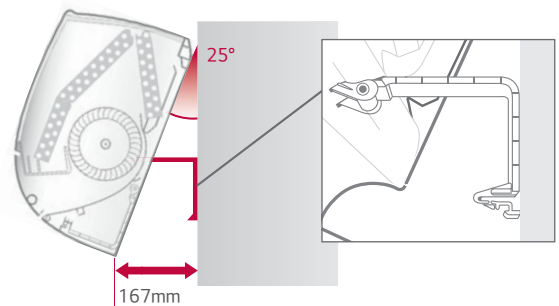

Auto Swing

Cool air extends to the entire room regardless of where the unit is situated.

※ Specifications may vary for each model.

6-Step Vane Control up to 70°

The vertical vane, which moves up and down, has 6 different settings including full-auto swing.

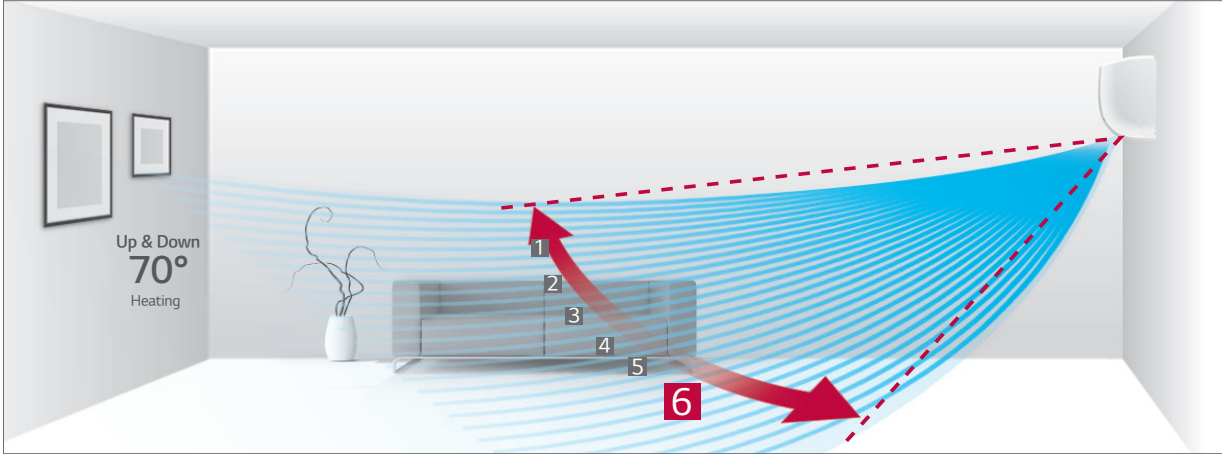

※ Angle can be different from each model and working mode.

Control up to 110°

Louver can be adjusted manually to extend left and right swing to 110 degrees.

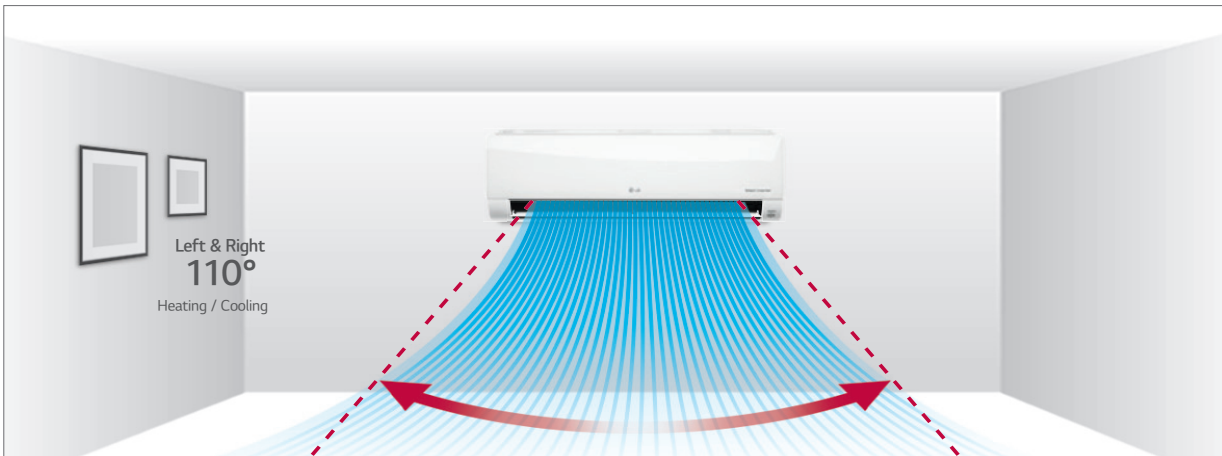

※ Angle can be different from each model and working mode.

Easy and Simple Control

Airflow direction can be changed by ThinQ Wi-Fi app.

※ For our policy of continuous ThinQ App improvement, specification, design and features are subject to change without prior notice.

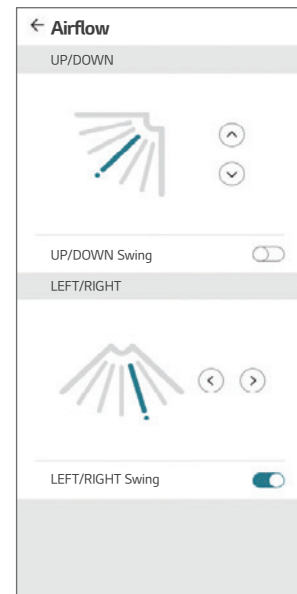

Up / Down Swing

Jet Cool

LG air conditioners provide optimized high-speed airflow, which can cool rooms faster while delivering cool air evenly in every direction.

※ Specifications may vary for each model.
※ Depending on the experimental conditions.

One Click "Jet Mode"

Reduces the temperature of outflowing air to 18°C for 30 minutes with just one click.

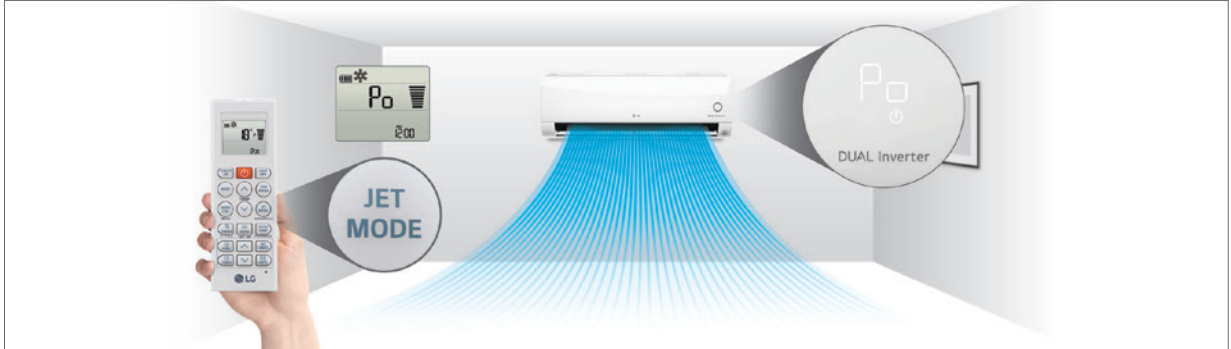

More Powerful Performance

By reducing the second vortex, which decreases airflow within the air outlet, and enlarging the fan size, the amount of air flow is increased to 13 CMM.

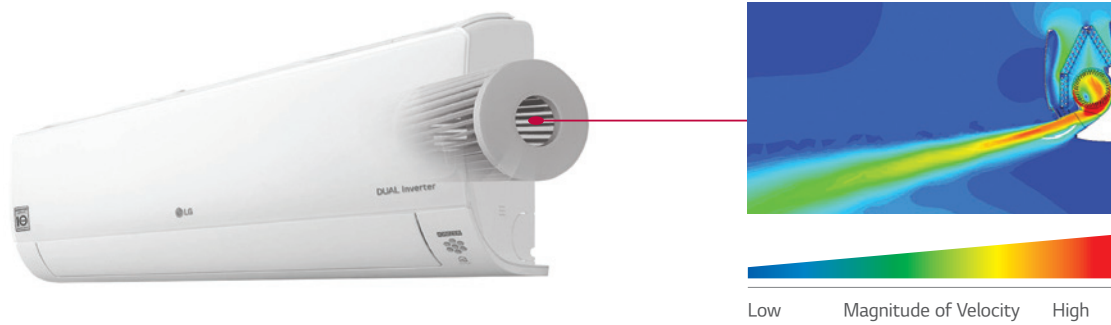

Scheduled Operation

You can set the daily temperature, fan speed, the operation mode and automatic On / Off time for two weeks. It will keep running on that time until cancelled by the user.

※ This function is for wired remote controller only.
 ※ Wired remote controller is need to be separately purchased.

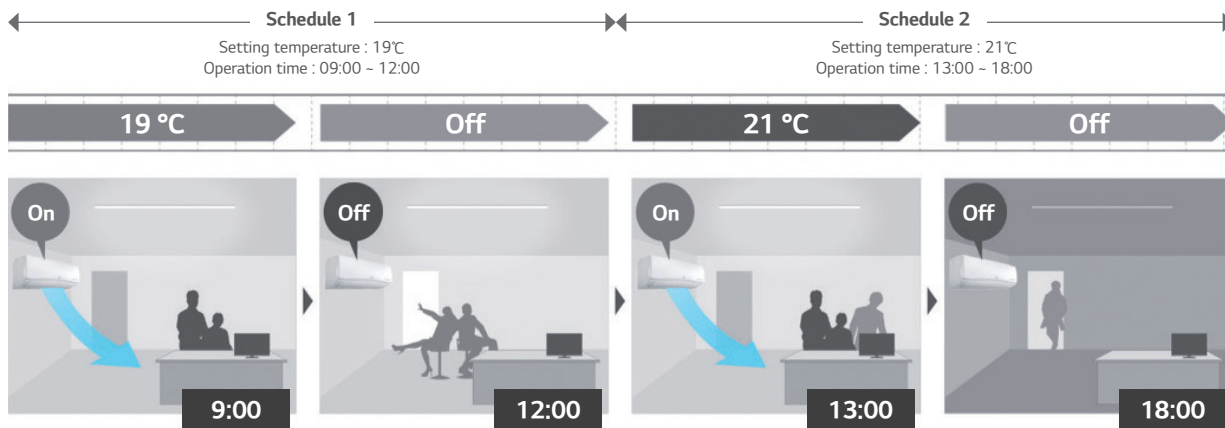

Two Thermistors Control

The indoor temperature can be checked using the thermistors in the remote controller as well as from the indoor unit. There may be a significant difference between ceiling and floor air temperature. Two thermistors can optimise indoor air temperature for a more comfortable environment.



Group Control

Group control by remote controller (PREMTB100 /PREMTBB10) has more functions than previous model.



**ARNU05GSJR4 / ARNU07GSJR4
ARNU09GSJR4 / ARNU12GSJR4
ARNU15GSJR4**



MODEL		UNIT	ARNU05GSJR4	ARNU07GSJR4	ARNU09GSJR4	ARNU12GSJR4	ARNU15GSJR4
Cooling Capacity		kW	1.6	2.2	2.8	3.6	4.5
Heating Capacity		kW	1.8	2.5	3.2	4.0	5.0
Power Input (H / M / L)		Nominal W	11 / 10 / 9	12 / 11 / 9	13 / 12 / 9	15 / 13 / 11	23 / 18 / 11
Exterior Color			Mirror (Black)	Mirror (Black)	Mirror (Black)	Mirror (Black)	Mirror (Black)
RAL Code			RAL 9005	RAL 9005	RAL 9005	RAL 9005	RAL 9005
Dimensions (W x H x D)	Body	mm	837 x 308 x 192	837 x 308 x 192	837 x 308 x 192	837 x 308 x 192	837 x 308 x 192
	Shipping	mm	892 x 381 x 249	892 x 381 x 249	892 x 381 x 249	892 x 381 x 249	892 x 381 x 249
Fan	Type		Cross Flow Fan	Cross Flow Fan	Cross Flow Fan	Cross Flow Fan	Cross Flow Fan
	Motor Output x Number	W x No.	30 x 1	30 x 1	30 x 1	30 x 1	30 x 1
	Air Flow Rate (H / M / L)	m ³ /min	6.8 / 6.5 / 5.9	7.2 / 6.8 / 5.9	7.8 / 7.2 / 5.9	8.5 / 7.8 / 6.8	10.5 / 9.5 / 6.8
	Motor Type		BLDC	BLDC	BLDC	BLDC	BLDC
Air Filter			Pre Filter	Pre Filter	Pre Filter	Pre Filter	Pre Filter
Pipe Connections	Liquid Side	mm (inch)	Ø6.35 (1/4)	Ø6.35 (1/4)	Ø6.35 (1/4)	Ø6.35 (1/4)	Ø6.35 (1/4)
	Gas Side	mm (inch)	Ø12.7 (1/2)	Ø12.7 (1/2)	Ø12.7 (1/2)	Ø12.7 (1/2)	Ø12.7 (1/2)
	Drain Pipe (Internal Dia.)	mm (inch)	Ø16 (5/8)	Ø16 (5/8)	Ø16 (5/8)	Ø16 (5/8)	Ø16 (5/8)
Weight	Body	kg	9.2	9.2	9.2	9.2	9.2
Sound Pressure Levels (H / M / L)		dB(A)	30 / 29 / 28	32 / 30 / 28	34 / 32 / 28	37 / 34 / 30	42 / 39 / 32
Sound Power Levels (H / M / L)		dB(A)	45 / 43 / 42	46 / 45 / 42	48 / 46 / 42	51 / 48 / 45	55 / 52 / 44
Power Supply		Ø, V, Hz	1, 220-230-240, 50/60	1, 220-230-240, 50/60	1, 220-230-240, 50/60	1, 220-230-240, 50/60	1, 220-230-240, 50/60
Transmission Cable		mm ²	1.0 ~ 1.5 x 2C	1.0 ~ 1.5 x 2C	1.0 ~ 1.5 x 2C	1.0 ~ 1.5 x 2C	1.0 ~ 1.5 x 2C

Note :

1. Performance tested under EN14511

2. Capacities are based on the following conditions

- Cooling : Indoor temp. 27°C (80.6°F) DB / 19°C (66.2°F) WB, Outdoor temp. 35°C (95°F) DB / 24°C (75.2°F) WB, Interconnecting piping length 7.5m, Level difference of zero

- Heating : Indoor temp. 20°C (68°F) DB / 15°C (59°F) WB, Outdoor temp. 7°C (44.6°F) DB / 6°C (42.8°F) WB, Interconnecting piping length 7.5m, Level difference of zero

3. Due to our policy of innovation, some specifications may be changed without notification

Accessories

CHASSIS	ARNU05GSJR4	ARNU07GSJR4	ARNU09GSJR4	ARNU12GSJR4	ARNU15GSJR4
Drain Pump			-		
Cassette Cover			-		
Refrigerant Leakage Detector			PRLDNVSO (R410a)		
EEV Kit			PRGK024A0		
Multi-tenant Power Module			PINPMB001		
Robot Cleaner			-		
Pre Filter (Washable)			○		
Ion Generator			○		
CO ₂ Sensor			-		
Ventilation Kit			-		
IR Receiver			-		
Zone Controller			-		
Dry Contact (with additional accessory)			PDRYCB000 (1 point contact), PDRYCB320, PDRYCB400 (2 points input), PDRYCB500 (Modbus)		
External Input (1 point)			○		
Wi-Fi			○		

※ ○ : Applied, - : Not applied

Option : Refer to model name in table

ARNU18GSKR4 / ARNU24GSKR4



MODEL	UNIT	ARNU18GSKR4	ARNU24GSKR4
Cooling Capacity	kW	5.6	7.1
Heating Capacity	kW	6.3	7.5
Power Input (H / M / L)	Nominal W	32 / 26 / 16	39 / 26 / 16
Exterior Color		Mirror (Black)	Mirror (Black)
RAL Code		RAL 9005	RAL 9005
Dimensions	Body mm	998 x 345 x 212	998 x 345 x 212
	Shipping mm	1,063 x 420 x 274	1,063 x 420 x 274
Fan	Type	Cross Flow Fan	Cross Flow Fan
	Motor Output x Number	W x No.	58 x 1
	Air Flow Rate (H / M / L)	m ³ /min	14.0 / 12.0 / 10.5
	Motor Type	BLDC	BLDC
Air Filter		Pre Filter	Pre Filter
Pipe Connections	Liquid Side	mm (inch)	Ø6.35 (1/4)
	Gas Side	mm (inch)	Ø12.7 (1/2)
	Drain Pipe (Internal Dia.)	mm (inch)	Ø16(5/8)
Weight	Body kg	13.4	13.4
Sound Pressure Levels (H / M / L)	dB(A)	43 / 39 / 34	46 / 41 / 34
Sound Power Levels (H / M / L)	dB(A)	59 / 56 / 52	63 / 58 / 52
Power Supply	Ø, V, Hz	1, 220-230-240, 50/60	1, 220-230-240, 50/60
Transmission Cable	mm ²	1.0 ~ 1.5 x 2C	1.0 ~ 1.5 x 2C

Note :

- Performance tested under EN14511
- Capacities are based on the following conditions
 - Cooling : Indoor temp. 27°C (80.6°F) DB / 19°C (66.2°F) WB, Outdoor temp. 35°C (95°F) DB / 24°C (75.2°F) WB, Interconnecting piping length 7.5m, Level difference of zero
 - Heating : Indoor temp. 20°C (68°F) DB / 15°C (59°F) WB, Outdoor temp. 7°C (44.6°F) DB / 6°C (42.8°F) WB, Interconnecting piping length 7.5m, Level difference of zero
- Due to our policy of innovation, some specifications may be changed without notification

Accessories

CHASSIS	ARNU18GSKR4	ARNU24GSKR4
Drain Pump		-
Cassette Cover		-
Refrigerant Leakage Detector		PRLDNVSO (R410a)
EEV Kit		PRGK024A0
Multi-tenant Power Module		PINPMB001
Robot Cleaner		-
Pre Filter (Washable)		○
Ion Generator		○
CO ₂ Sensor		-
Ventilation Kit		-
IR Receiver		-
Zone Controller		-
Dry Contact (with additional accessory)		PDRYCB000 (1 point contact), PDRYCB320, PDRYCB400 (2 points input), PDRYCB500 (Modbus)
External Input (1 point)		○
Wi-Fi		○

※ ○ : Applied, - : Not applied
Option : Refer to model name in table

ARNU07GSF14 / ARNU09GSF14 ARNU12GSF14

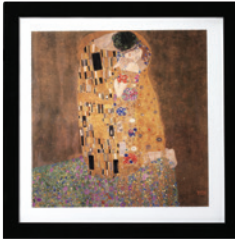

MODEL		UNIT	ARNU07GSF14	ARNU09GSF14	ARNU12GSF14	
Cooling Capacity		kW	2.2	2.8	3.6	
Heating Capacity		kW	2.5	3.2	4.0	
Power Input (H / M / L)		Nominal W	28 / 16 / 10	28 / 16 / 10	32 / 20 / 12	
Dimensions (W x H x D)		Body	600 x 600 x 146	600 x 600 x 146	600 x 600 x 146	
		Shipping	685 x 670 x 215	685 x 670 x 215	685 x 670 x 215	
Fan		Type	Turbo Fan	Turbo Fan	Turbo Fan	
		Motor Output x Number	W x No.	30 x 1	30 x 1	30 x 1
		Air Flow Rate (H / M / L)	m ³ /min	8.1 / 6.3 / 4.2	8.1 / 6.3 / 4.2	9.3 / 7.7 / 6.0
		Motor Type		BLDC	BLDC	BLDC
Air Filter			Pre Filter	Pre Filter	Pre Filter	
Pipe Connections		Liquid Side	mm (inch)	Ø6.35 (1/4)	Ø6.35 (1/4)	
		Gas Side	mm (inch)	Ø12.7 (1/2)	Ø12.7 (1/2)	
		Drain Pipe (Internal Dia.)	mm (inch)	Ø12.2 (15/32)	Ø12.2 (15/32)	
Weight	Body	kg	15.4	15.4	15.4	
Sound Pressure Levels (H / M / L)		dB(A)	38 / 32 / 27	38 / 32 / 27	44 / 38 / 32	
Sound Power Levels (H / M / L)		dB(A)	48 / 46 / 41	48 / 46 / 41	54 / 48 / 42	
Power Supply		Ø, V, Hz	1, 220-230-240, 50/60	1, 220-230-240, 50/60	1, 220-230-240, 50/60	
Transmission Cable		mm ²	1.0 ~ 1.5 x 2C	1.0 ~ 1.5 x 2C	1.0 ~ 1.5 x 2C	

Note :

- Performance tested under EN14511
- Capacities are based on the following conditions
 - Cooling : Indoor temp. 27°C (80.6°F) DB / 19°C (66.2°F) WB, Outdoor temp. 35°C (95°F) DB / 24°C (75.2°F) WB, Interconnecting piping length 7.5m, Level difference of zero
 - Heating : Indoor temp. 20°C (68°F) DB / 15°C (59°F) WB, Outdoor temp. 7°C (44.6°F) DB / 6°C (42.8°F) WB, Interconnecting piping length 7.5m, Level difference of zero
- Due to our policy of innovation, some specifications may be changed without notification

Accessories

CHASSIS	ARNU07GSF14	ARNU09GSF14	ARNU12GSF14
Drain Pump		-	
Cassette Cover		-	
Refrigerant Leakage Detector		PRLDNVSO (R410a)	
EEV Kit		PRGK024A0	
Multi-tenant Power Module		PINPMB001	
Robot Cleaner		-	
Pre Filter (Washable)		○	
Ion Generator		-	
CO ₂ Sensor		-	
Ventilation Kit		-	
IR Receiver		-	
Zone Controller		-	
Dry Contact (with additional accessory)		PDRYCB000 (1 point contact), PDRYCB320, PDRYCB400 (2 points input), PDRYCB500 (Modbus)	
External Input (1 point)		○	
Wi-Fi		PWFMD200 ¹⁾	

- ※ ○ : Applied, - : Not applied
 Option : Refer to model name in table
 1) External installation only

**ARNU05GSJ*4 / ARNU07GSJ*4 / ARNU09GSJ*4
ARNU12GSJ*4 / ARNU15GSJ*4**

MODEL	UNIT	ARNU05GSJ*4	ARNU07GSJ*4	ARNU09GSJ*4	ARNU12GSJ*4	ARNU15GSJ*4	
Cooling Capacity	kW	1.6	2.2	2.8	3.6	4.5	
Heating Capacity	kW	1.8	2.5	3.2	4.0	5.0	
Power Input (H / M / L)	Nominal W	11 / 10 / 9	12 / 11 / 9	13 / 12 / 9	15 / 13 / 11	23 / 18 / 11	
Exterior Color		White	White	White	White	White	
RAL Code		RAL 9016	RAL 9016	RAL 9016	RAL 9016	RAL 9016	
Dimensions	Body mm	818 x 316 x 189	818 x 316 x 189	818 x 316 x 189	818 x 316 x 189	818 x 316 x 189	
(W x H x D)	Shipping mm	892 x 381 x 249	892 x 381 x 249	892 x 381 x 249	892 x 381 x 249	892 x 381 x 249	
Fan	Type	Cross Flow Fan	Cross Flow Fan	Cross Flow Fan	Cross Flow Fan	Cross Flow Fan	
	Motor Output x Number	W x No.	30 x 1	30 x 1	30 x 1	30 x 1	
	Air Flow Rate (H / M / L)	m ³ /min	6.8 / 6.5 / 5.9	7.2 / 6.8 / 5.9	7.8 / 7.2 / 5.9	8.5 / 7.8 / 6.8	10.5 / 9.5 / 6.8
	Motor Type		BLDC	BLDC	BLDC	BLDC	BLDC
Air Filter		Pre Filter	Pre Filter	Pre Filter	Pre Filter	Pre Filter	
Pipe Connections	Liquid Side	mm (inch)	Ø6.35 (1/4)	Ø6.35 (1/4)	Ø6.35 (1/4)	Ø6.35 (1/4)	
	Gas Side	mm (inch)	Ø12.7 (1/2)	Ø12.7 (1/2)	Ø12.7 (1/2)	Ø12.7 (1/2)	
	Drain Pipe (Internal Dia.)	mm (inch)	Ø16 (5/8)	Ø16 (5/8)	Ø16 (5/8)	Ø16 (5/8)	
Weight	Body kg	8.4	8.4	8.4	8.4	8.4	
Sound Pressure Levels (H / M / L)	dB(A)	30 / 29 / 28	32 / 30 / 28	34 / 32 / 28	37 / 34 / 30	42 / 39 / 32	
Sound Power Levels (H / M / L)	dB(A)	45 / 43 / 42	46 / 45 / 42	48 / 46 / 42	51 / 48 / 45	55 / 52 / 45	
Power Supply	Ø, V, Hz	1, 220-230-240, 50/60	1, 220-230-240, 50/60	1, 220-230-240, 50/60	1, 220-230-240, 50/60	1, 220-230-240, 50/60	
Transmission Cable	mm ²	1.0 ~ 1.5 x 2C	1.0 ~ 1.5 x 2C	1.0 ~ 1.5 x 2C	1.0 ~ 1.5 x 2C	1.0 ~ 1.5 x 2C	

*: N or C can be applied which has little bit different shape of panel.

Note :

1. Performance tested under EN14511

2. Capacities are based on the following conditions

- Cooling : Indoor temp. 27°C (80.6°F) DB / 19°C (66.2°F) WB, Outdoor temp. 35°C (95°F) DB / 24°C (75.2°F) WB, Interconnecting piping length 7.5m, Level difference of zero

- Heating : Indoor temp. 20°C (68°F) DB / 15°C (59°F) WB, Outdoor temp. 7°C (44.6°F) DB / 6°C (42.8°F) WB, Interconnecting piping length 7.5m, Level difference of zero

3. Due to our policy of innovation, some specifications may be changed without notification

Accessories

CHASSIS	ARNU05GSJ*4	ARNU07GSJ*4	ARNU09GSJ*4	ARNU12GSJ*4	ARNU15GSJ*4
Drain Pump				-	
Cassette Cover				-	
Refrigerant Leakage Detector				PRLDNV50 (R410a)	
EEV Kit				PRGK024A0	
Multi-tenant Power Module				PINPMB001	
Robot Cleaner				-	
Pre Filter (Washable)				○	
Ion Generator				○	
CO ₂ Sensor				-	
Ventilation Kit				-	
IR Receiver				-	
Zone Controller				-	
Dry Contact (with additional accessory)				PDRYCB000 (1 point contact), PDRYCB320, PDRYCB400 (2 points input), PDRYCB500 (Modbus)	
External Input (1 point)				○	
Wi-Fi				○	

※ ○ : Applied, - : Not applied

Option : Refer to model name in table

ARNU18GSK*4 / ARNU24GSK*4



MODEL	UNIT	ARNU18GSK*4	ARNU24GSK*4
Cooling Capacity	kW	5.6	7.1
Heating Capacity	kW	6.3	7.5
Power Input (H / M / L)	Nominal W	32 / 26 / 16	39 / 26 / 16
Exterior Color		White	White
RAL Code		RAL 9016	RAL 9016
Dimensions (W x H x D)	Body mm	975 x 354 x 209	975 x 354 x 209
	Shipping mm	1,063 x 420 x 274	1,063 x 420 x 274
Fan	Type	Cross Flow Fan	Cross Flow Fan
	Motor Output x Number W x No.	58 x 1	58 x 1
	Air Flow Rate (H / M / L) m ³ /min	14.0 / 12.0 / 10.5	15.2 / 12.7 / 10.5
	Motor Type	BLDC	BLDC
Air Filter		Pre Filter	Pre Filter
Pipe Connections	Liquid Side mm (inch)	Ø6.35 (1/4)	Ø9.52 (3/8)
	Gas Side mm (inch)	Ø12.7 (1/2)	Ø15.88 (5/8)
	Drain Pipe (Internal Dia.) mm (inch)	Ø16 (5/8)	Ø16 (5/8)
Weight	Body kg	12.2	12.2
Sound Pressure Levels (H / M / L)	dB(A)	43 / 39 / 34	46 / 41 / 34
Sound Power Levels (H / M / L)	dB(A)	59 / 56 / 52	63 / 56 / 52
Power Supply	Ø, V, Hz	1, 220-230-240, 50/60	1, 220-230-240, 50/60
Transmission Cable	mm ²	1.0 - 1.5 x 2C	1.0 - 1.5 x 2C

* : N or C can be applied which has little bit different shape of panel.

Note :

1. Performance tested under EN14511

2. Capacities are based on the following conditions

- Cooling : Indoor temp. 27°C (80.6°F) DB / 19°C (66.2°F) WB, Outdoor temp. 35°C (95°F) DB / 24°C (75.2°F) WB, Interconnecting piping length 7.5m, Level difference of zero

- Heating : Indoor temp. 20°C (68°F) DB / 15°C (59°F) WB, Outdoor temp. 7°C (44.6°F) DB / 6°C (42.8°F) WB, Interconnecting piping length 7.5m, Level difference of zero

3. Due to our policy of innovation, some specifications may be changed without notification

Accessories

CHASSIS	ARNU18GSK*4	ARNU24GSK*4
Drain Pump		-
Cassette Cover		-
Refrigerant Leakage Detector		PRLDNVSO (R410a)
EEV Kit		PRGK024A0
Multi-tenant Power Module		PINPMB001
Robot Cleaner		-
Pre Filter (Washable)		○
Ion Generator		○
CO ₂ Sensor		-
Ventilation Kit		-
IR Receiver		-
Zone Controller		-
Dry Contact (with additional accessory)		PDRYCB000 (1 point contact), PDRYCB320, PDRYCB400 (2 points input), PDRYCB500 (Modbus)
External Input (1 point)		○
Wi-Fi		○

※ ○ : Applied, - : Not applied

Option : Refer to model name in table

ARNU30GSVA4 / ARNU36GSVA4



MODEL	UNIT	ARNU30GSVA4	ARNU36GSVA4
Cooling Capacity	kW	8.8	10.4
Heating Capacity	kW	9.4	10.8
Power Input (H / M / L)	Nominal W	54 / 43 / 31	85 / 51 / 36
Exterior Color		White	White
RAL Code		RAL 9016	RAL 9016
Dimensions	Body mm	1,190 x 346 x 265	1,190 x 346 x 265
	Shipping mm	1,265 x 432 x 335	1,265 x 432 x 335
Fan	Type	Cross Flow Fan	Cross Flow Fan
	Motor Output x Number	W x No.	113 x 1
	Air Flow Rate (H / M / L)	m ³ /min	23.0 / 20.0 / 17.0
	Motor Type	BLDC	BLDC
Air Filter		Pre Filter	Pre Filter
Pipe Connections	Liquid Side	mm (inch)	Ø9.52 (3/8)
	Gas Side	mm (inch)	Ø15.88 (5/8)
	Drain Pipe (Internal Dia.)	mm (inch)	Ø16 (5/8)
Weight	Body kg	16.6	16.6
Sound Pressure Levels (H / M / L)	dB(A)	49 / 44 / 42	52 / 47 / 43
Sound Power Levels (H / M / L)	dB(A)	60 / 60 / 56	63 / 60 / 58
Power Supply	Ø, V, Hz	1, 220-230-240, 50/60	1, 220-230-240, 50/60
Transmission Cable	mm ²	1.0 ~ 1.5 x 2C	1.0 ~ 1.5 x 2C

Note :

1. Performance tested under EN14511

2. Capacities are based on the following conditions

- Cooling : Indoor temp. 27°C (80.6°F) DB / 19°C (66.2°F) WB, Outdoor temp. 35°C (95°F) DB / 24°C (75.2°F) WB, Interconnecting piping length 7.5m, Level difference of zero

- Heating : Indoor temp. 20°C (68°F) DB / 15°C (59°F) WB, Outdoor temp. 7°C (44.6°F) DB / 6°C (42.8°F) WB, Interconnecting piping length 7.5m, Level difference of zero

3. Due to our policy of innovation, some specifications may be changed without notification

Accessories

CHASSIS	ARNU30GSVA4	ARNU36GSVA4
Drain Pump		-
Cassette Cover		-
Refrigerant Leakage Detector		PRLDNV50 (R410a)
EEV Kit		-
Multi-tenant Power Module		PINPMB001
Robot Cleaner		-
Pre Filter (Washable)		○
Ion Generator		-
CO ₂ Sensor		-
Ventilation Kit		-
IR Receiver		-
Zone Controller		-
Dry Contact (with additional accessory)		PDRYCB000 (1 point contact), PDRYCB320, PDRYCB400 (2 points input), PDRYCB500 (Modbus)
External Input (1 point)		○
Wi-Fi		PWFMD200 ¹⁾

※ ○ : Applied, - : Not applied

Option : Refer to model name in table

1) External installation only

CEILING MOUNTED CASSETTE



Features & Benefits

- New dual vane 4 way cassette allows comfortable air flow
- Full 3D Turbo fan decreases air resistance, providing high air flow and low sound levels.

Key Applications

- Retail
- School
- Office
- Hotel
- Dormitory
- Restaurant

CASSETTE		4 WAY	2 WAY	1 WAY
Smart	Wi-Fi	○	○	○
Energy Efficiency	Human Detect Sensor	○	-	-
	Drain Pump	○	○	○
	Sleep Mode	○	○	○
Comfort	Timer (On / Off)	○	○	○
	Timer (Weekly)	○	○	○
	Two Thermistor Control	○	○	○
	Group Control	○	○	○

※ ○: Applied, - : Not applied

4 Way Air Flow with New Design

New Excellent Technology (NET) certifies new 4 way dual vane design that promotes comfortable and convenient airflow.



*New types wind

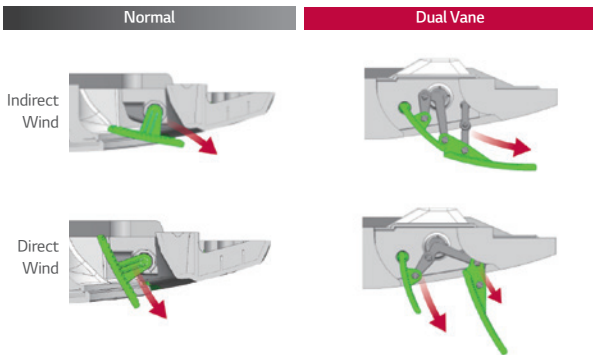

*6 Airflows mode

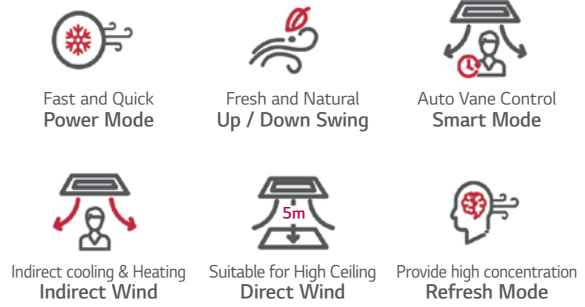

Brighter Color

Color enhancement allows cassette to blend in to most interior ceiling spaces.

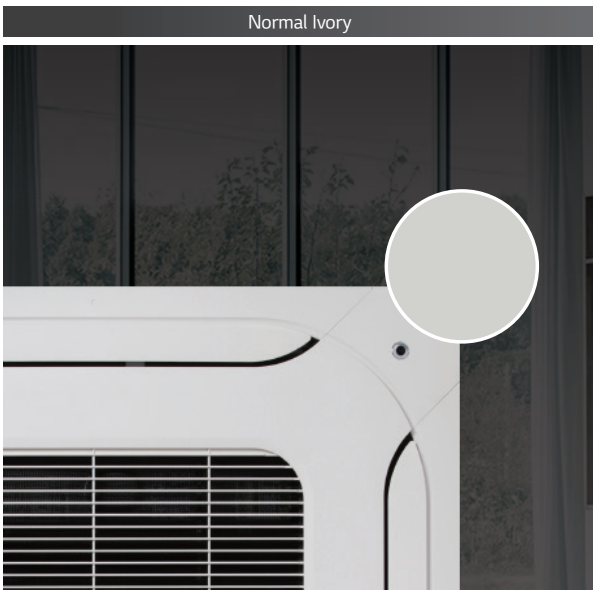

Wide Design

Bigger inlet and outlet make faster cooling / heating airflow.

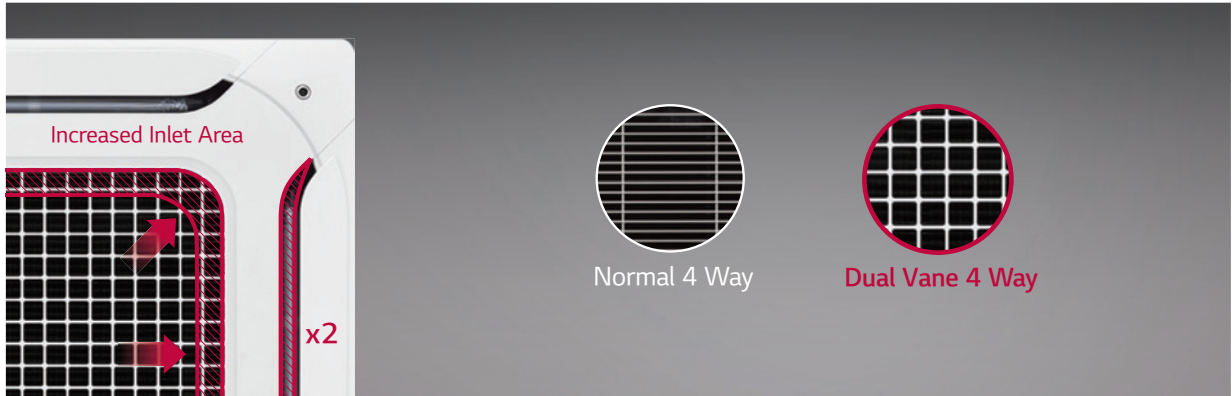

Full 3D Turbo Fan

Full 3D Turbo fan decreases air resistance, so it creates high efficiency and reduces noise level.



High Efficiency Heat Exchanger (HEX)

Ø5 High Density Heat Exchanger increases cooling / heating efficiency by 10%.

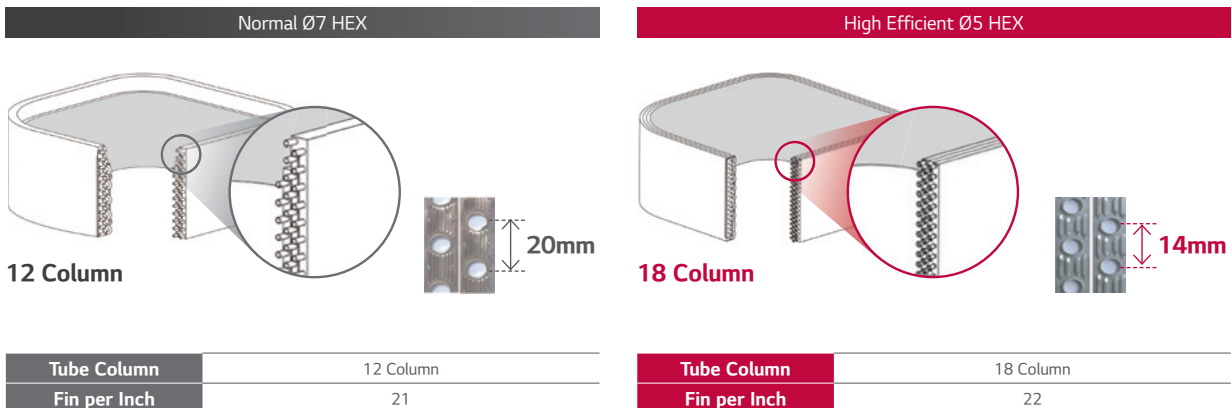

Ceiling to Floor Temperature Sensing

With a special sensor that senses both ceiling and floor temperature, dual vane 4 way cassette provides comfort air.



Human Detection Air Flow

Human detection provides users with direct or indirect air flow preferences.

Indirect comfort

Provides air flow that blows away from user for comfort.



Direct cooling

Provides air flow that blows directly onto user for cooling.



Human Detection for Optimized Efficiency

Indoor unit senses human presence to switch on or off for maximum power savings of 54%.

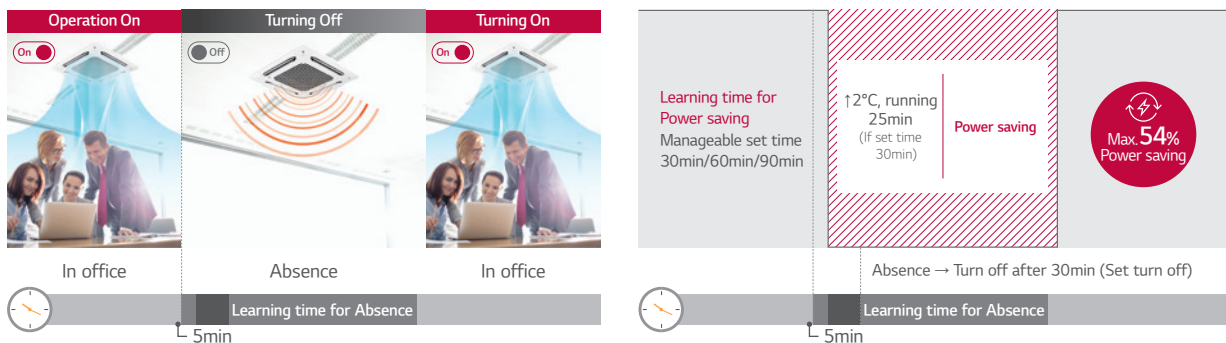

※ Smart Dual Vane Indoor Unit '19 Line up.
 ※ Data Based on actual test of LG, single product 2 hours measurement result. (Cooling 26 °C, strong wind)

High-performance Air Cleaning

Air cleaning function provides fresh, filtered air.



Convenient & Powerful 5-Step Air Purification

Easy-to-manage Air Purification system with one-touch Air Purification filter.

Air Purification kit

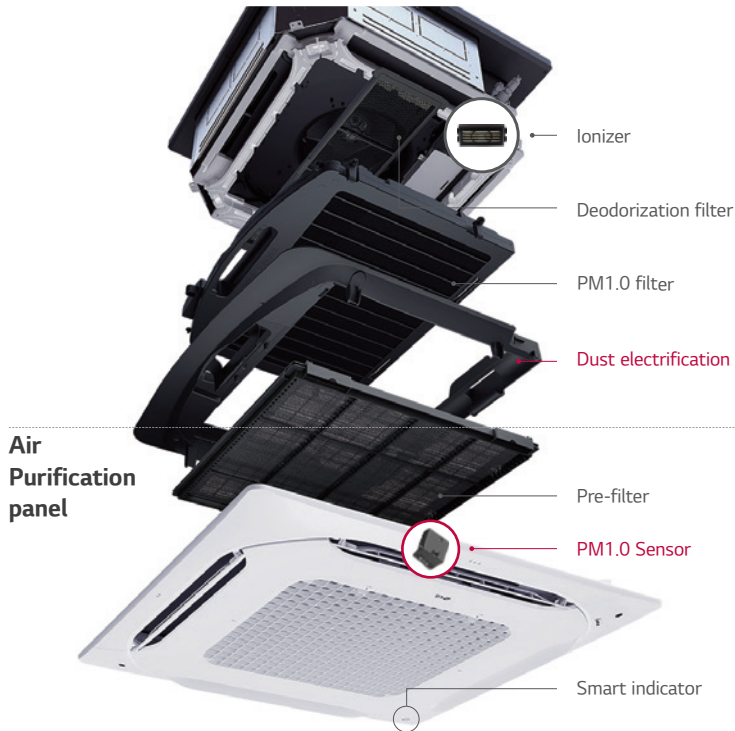

Cycle Management

Pre-filter	PM1.0 Filter	Deodorization Filter
Washable	6 months / Washable	6 months / Dry in sunlight

Air Quality Level Display

Wi-Fi functionality for anytime, anywhere indoor unit control and air quality level display.

<p>① IDU LED</p> <p>Real-time indoor air quality level displayed on indoor unit</p>  <p> ■ Good ■ Moderate ■ Unhealthy ■ Poor </p>	<p>② Remote controller</p> <p>Air quality level displayed on remote controller</p> 	<p>③ Mobile</p> <p>Anytime, anywhere access to check & control air status via mobile</p> 
--------------------------------------------------------------------------------------------------------------------------------------------------------------------------------------------------------------------------------------------------------------------------------------------------------------------------------------------------------------------------------------------	-----------------------------------------------------------------------------------------------------------------------------------------------------------------------------	----------------------------------------------------------------------------------------------------------------------------------------------------------------------------------------

Direct Wind

Wind can reach up to 5m with plenty air volume. (@ 0.5ms)



Dual Vane 4Way Cassette must set a Super High Ceiling Mode.

Recommended direct wind reach



* Settings are required in installer mode.

ThinQ Connectivity

Grille automatically detaches and re-attaches with 4 touch points for enhanced stability & convenient filter management.

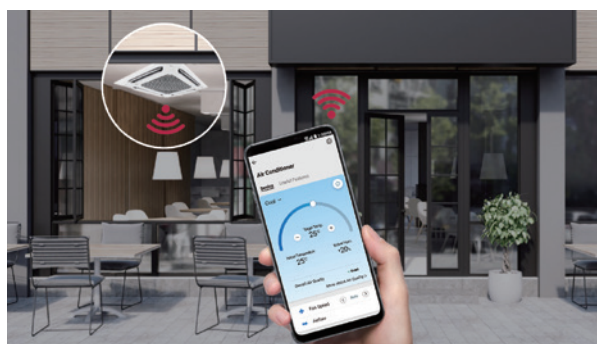

- ① Monitoring Air status : Easy to check indoor air status
 - Ultra Fine / Extra Fine / Fine Dust
 - Day / Week /Month / Yearly
- ② Mobile Remote Control : Remote control by using mobile phone
 - Control Mode / Temperature / Air flow etc.
- ③ Display Power Consumption : Check power consumption of A/C
 - Check energy display
 - Set target energy consumption level

※ For our policy of continuous ThinQ App improvement, specification, design and features are subject to change without prior notice.

Easy Filter Cleaning for Air Purification

Air Purification Kit filters do NOT need replacement and can be used semi-permanently. Also, thanks to easy maintenance, users can use air purification conveniently without any worries about filter's cleanliness.

Air Purification kit

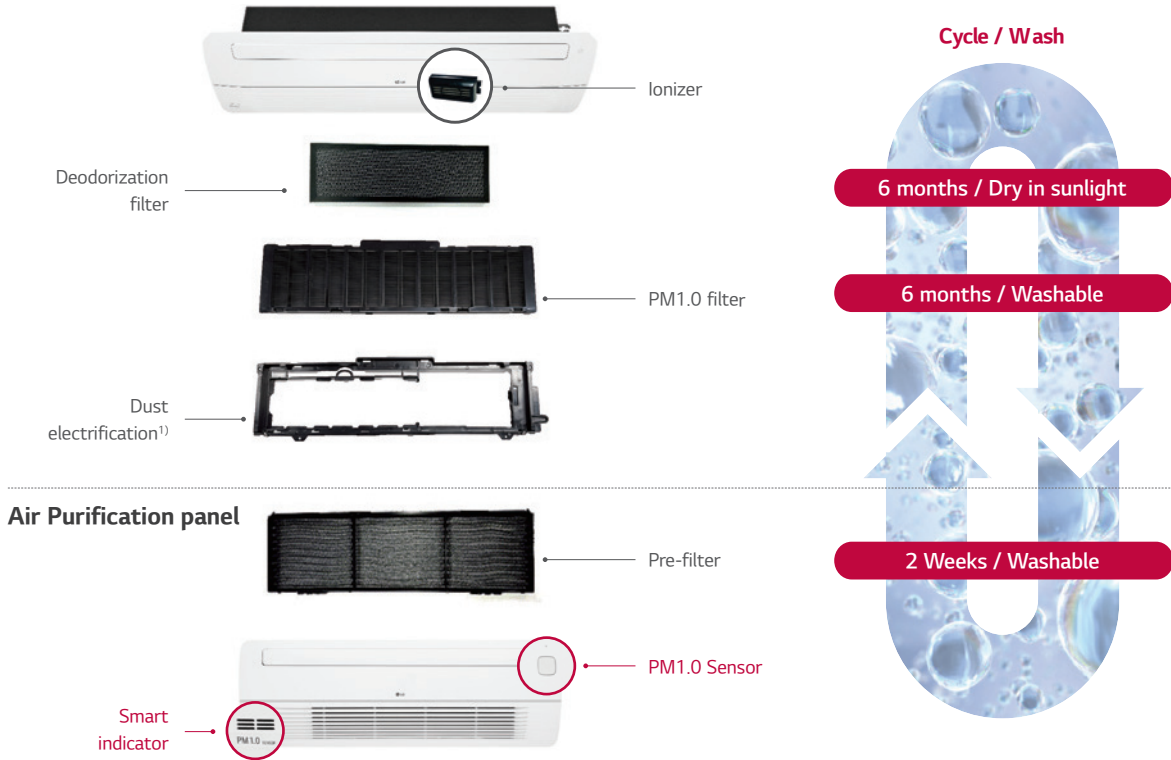

1) It increases the electrostatic force of particle to improve collection efficiency
 ※ Normally HEPA filter type must be replaced regularly. It means that it costs expensive for maintenance.

Direct & Indirect Wind

Provides users with direct or indirect air flow preferences.

Comfort indirect wind

Without touching the skin directly, a large space is comfortable!



Cooler on a hot day.



Minimized Height (1 Way)

With a height of 132mm, the LG 1 Way cassette is the ideal solution for limited-space installations.

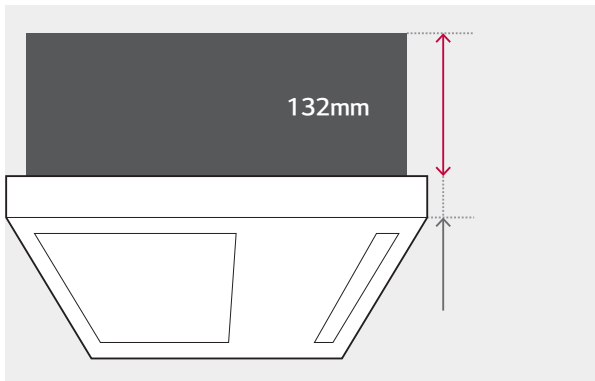

Size Comparison

(Unit : mm)

	A Company	B company	LG
1 Way Cassette	215	230	132

Flexible Installation (1 Way)

1 Way cassette doesn't require the inspection access hole, so that simple installation is possible.

1 Way cassette

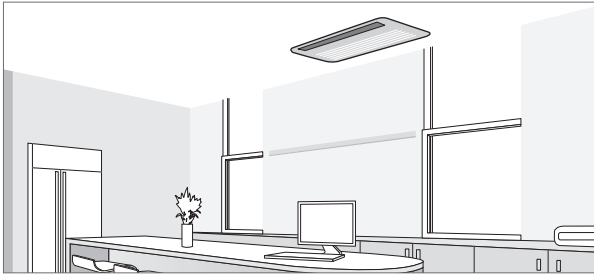

Duct

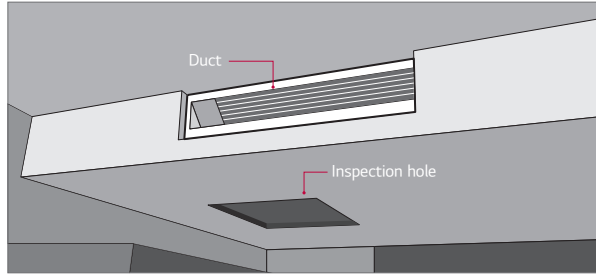

Installation Standard (1 Way)

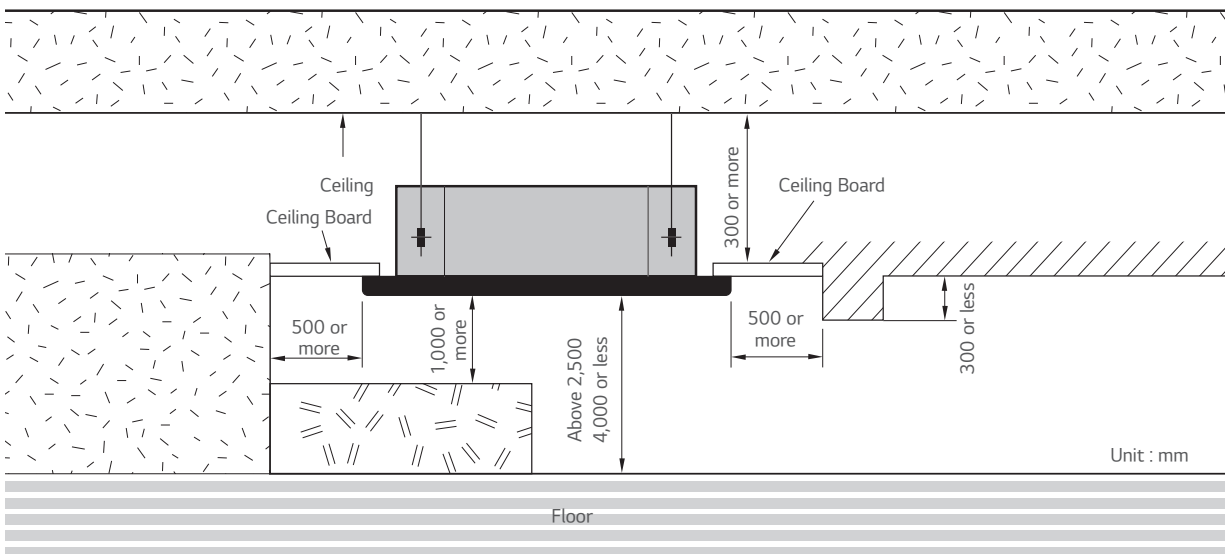

Safe Plus Insulation

Why LG Safe Plus Insulation?

Safe Plus Insulation is an antimicrobial treatment that is applied to LG MULTI V Indoor unit internal insulation components to resistance bacterial growth, and provides cleaner and fresher airflow to customer.

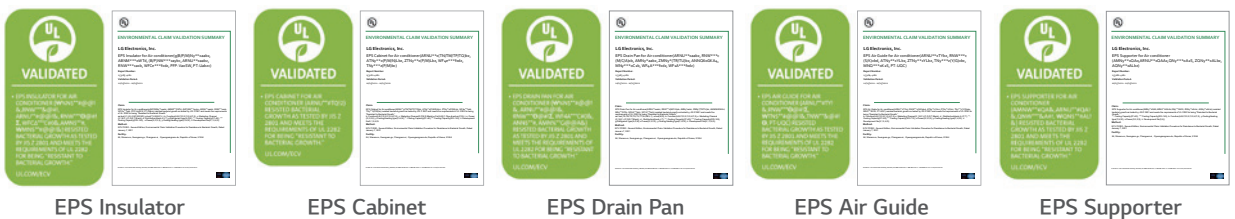
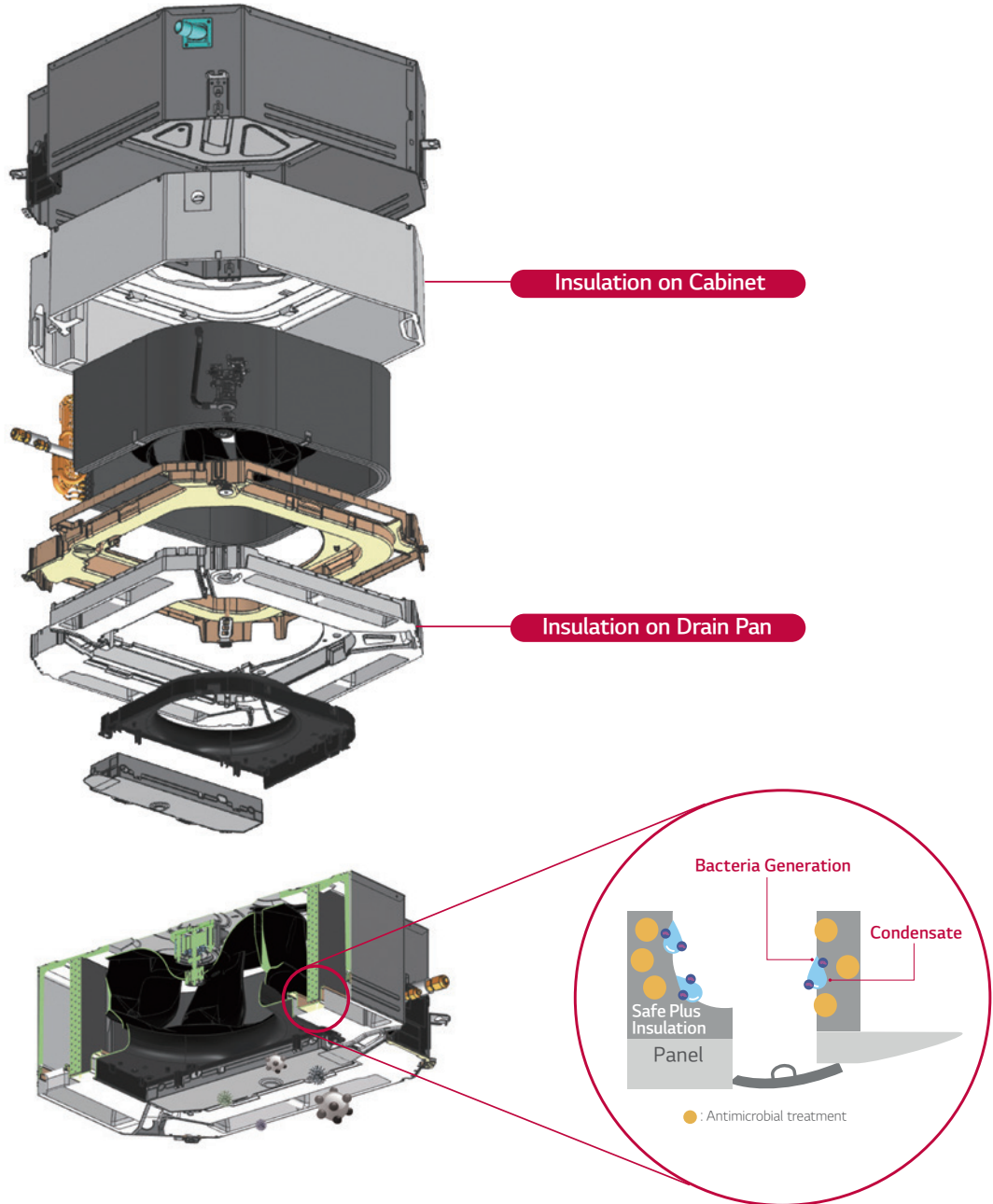

What's the hygiene inside of your air conditioner?



Example of EPS Pollution case.

Today's air conditioners, as well as fast cooling & energy saving are now basic, and all brand communicate each benefit of filtering bacteria, dust and mold and purifying contaminated air. However, What's the hygiene inside the air conditioner? If the inside of the air conditioner is contaminated, what can you do?

Antimicrobial treatment on ***EPS (Cabinet, Drain Pan, Air Guide, Insulator, Supporter)** for Air Conditioners is the first applied technology in the world, and only LG has.

EPS for Resistant to Bacterial Growth applied product



**ARNU24GTBB4 / ARNU28GTBB4
ARNU30GTBB4**



MODEL		UNIT	ARNU24GTBB4	ARNU28GTBB4	ARNU30GTBB4
Cooling Capacity		kW	7.1	8.2	9.0
Heating Capacity		kW	8.0	9.2	10.0
Power Input (H / M / L)	Nominal	W	32 / 27 / 20	37 / 30 / 22	48 / 36 / 25
Dimensions (W x H x D)	Body	mm	840 x 204 x 840	840 x 204 x 840	840 x 204 x 840
	Shipping	mm	922 x 276 x 917	922 x 276 x 917	922 x 276 x 917
Fan	Type		Full 3D Turbo Fan	Full 3D Turbo Fan	Full 3D Turbo Fan
	Motor Output x Number	W	51 x 1	51 x 1	51 x 1
	Air Flow Rate (H / M / L)	m ³ /min	18 / 17 / 15	19 / 17 / 15	21 / 19 / 16
	Motor Type		BLDC	BLDC	BLDC
Air Filter			Pre Filter	Pre Filter	Pre Filter
Pipe Connections	Liquid Side	mm (inch)	Ø9.52 (3/8)	Ø9.52 (3/8)	Ø9.52 (3/8)
	Gas Side	mm (inch)	Ø15.88 (5/8)	Ø15.88 (5/8)	Ø15.88 (5/8)
	Drain Pipe (Internal Dia.)	mm (inch)	Ø25 (1)	Ø25 (1)	Ø25 (1)
Weight	Body	kg	21	21	21
Sound Pressure Level (H / M / L)		dB(A)	39 / 37 / 35	40 / 38 / 35	43 / 40 / 36
Sound Power Level (H / M / L)		dB(A)	46 / 44 / 42	50 / 46 / 43	53 / 50 / 45
Power Supply		Ø, V, Hz	1, 220-240, 50	1, 220-240, 50	1, 220-240, 50
Communication Cable (VCTF-SB)		mm ² x cores	1.0 - 1.5 x 2	1.0 - 1.5 x 2	1.0 - 1.5 x 2
Decoration Panel (Accessory)	Model Name		PT-AAGW0 PT-AFGW0	PT-AAGW0 PT-AFGW0	PT-AAGW0 PT-AFGW0
	Exterior Color		White	White	White
	RAL Code		RAL 9003	RAL 9003	RAL 9003
	Net Dimensions (W x H x D)	mm	950 x 35 x 950	950 x 35 x 950	950 x 35 x 950
	Net Weight	kg	7.1 / 7.5	7.1 / 7.5	7.1 / 7.5

Note :

- Performance tested under EN14511
- Capacities are based on the following conditions
 - Cooling : Indoor temp. 27°C (80.6°F) DB / 19°C (66.2°F) WB, Outdoor temp. 35°C (95°F) DB / 24°C (75.2°F) WB, Interconnecting piping length 7.5m, Level difference of zero
 - Heating : Indoor temp. 20°C (68°F) DB / 15°C (59°F) WB, Outdoor temp. 7°C (44.6°F) DB / 6°C (42.8°F) WB, Interconnecting piping length 7.5m, Level difference of zero
- Due to our policy of innovation, some specifications may be changed without notification

Accessories

CHASSIS	ARNU24GTBB4	ARNU28GTBB4	ARNU30GTBB4
Drain Pump		○	
Cassette Cover		PTDCA	
Refrigerant Leakage Detector		PRLDNVSO (R410a)	
EEV Kit		-	
Multi-tenant Power Module		PINPMB001	
Robot Cleaner		-	
Pre Filter (Washable)		○	
Ion Generator		-	
CO ₂ Sensor		-	
Ventilation Kit		-	
IR Receiver		-	
Zone Controller		-	
Dry Contact (with additional accessory)		PDRYCB000 (1 point contact), PDRYCB320, PDRYCB400 (2 points input), PDRYCB500 (Modbus)	
External Input (1 Point)		○	
Wi-Fi		PWFMD200	
Human Detection Sensor		PTVSA00	
Floor Temperature Sensor		PTFSMA0	
Air Purification Kit		PTAHMPO (PT-AFGW0 panel required)	
Elevation Grille		-	

ARNU36GTAB4 / ARNU42GTAB4 ARNU48GTAB4



MODEL		UNIT	ARNU36GTAB4	ARNU42GTAB4	ARNU48GTAB4
Cooling Capacity		kW	10.6	12.3	14.1
Heating Capacity		kW	11.9	13.8	15.9
Power Input (H / M / L)	Nominal	W	69 / 49 / 37	97 / 69 / 49	110 / 76 / 61
Dimensions (W x H x D)	Body	mm	840 x 288 x 840	840 x 288 x 840	840 x 288 x 840
	Shipping	mm	922 x 360 x 917	922 x 360 x 917	922 x 360 x 917
Fan	Type		Full 3D Turbo Fan	Full 3D Turbo Fan	Full 3D Turbo Fan
	Motor Output x Number	W	135 x 1	135 x 1	135 x 1
	Air Flow Rate (H / M / L)	m ³ /min	29 / 26 / 22	33 / 29 / 26	34 / 30 / 28
	Motor Type		BLDC	BLDC	BLDC
Air Filter			Pre Filter	Pre Filter	Pre Filter
Pipe Connections	Liquid Side	mm (inch)	Ø9.52 (3/8)	Ø9.52 (3/8)	Ø9.52 (3/8)
	Gas Side	mm (inch)	Ø15.88 (5/8)	Ø15.88 (5/8)	Ø15.88 (5/8)
	Drain Pipe (Internal Dia.)	mm (inch)	Ø25 (1)	Ø25 (1)	Ø25 (1)
Weight	Body	kg	26	26	26
Sound Pressure Level (H / M / L)		dB(A)	43 / 40 / 37	47 / 43 / 40	48 / 44 / 42
Sound Power Level (H / M / L)		dB(A)	54 / 51 / 47	56 / 53 / 49	58 / 54 / 53
Power Supply		Ø, V, Hz	1, 220-240, 50	1, 220-240, 50	1, 220-240, 50
Communication Cable (VCTF-SB)		mm ² x cores	1.0 ~ 1.5 x 2	1.0 ~ 1.5 x 2	1.0 ~ 1.5 x 2
Decoration Panel (Accessory)	Model Name		PT-AAGW0 PT-AFGW0	PT-AAGW0 PT-AFGW0	PT-AAGW0 PT-AFGW0
	Exterior Color		White	White	White
	RAL Code		RAL 9003	RAL 9003	RAL 9003
	Net Dimensions (W x H x D)	mm	950 x 35 x 950	950 x 35 x 950	950 x 35 x 950
	Net Weight	kg	7.1 / 7.5	7.1 / 7.5	7.1 / 7.5

Note : 1. Performance tested under EN14511

2. Capacities are based on the following conditions

- Cooling : Indoor temp. 27°C (80.6°F) DB / 19°C (66.2°F) WB, Outdoor temp. 35°C (95°F) DB / 24°C (75.2°F) WB, Interconnecting piping length 7.5m, Level difference of zero

- Heating : Indoor temp. 20°C (68°F) DB / 15°C (59°F) WB, Outdoor temp. 7°C (44.6°F) DB / 6°C (42.8°F) WB, Interconnecting piping length 7.5m, Level difference of zero

3. Due to our policy of innovation, some specifications may be changed without notification

Accessories

CHASSIS	ARNU36GTAB4	ARNU42GTAB4	ARNU48GTAB4
Drain Pump		○	
Cassette Cover		PTDCA	
Refrigerant Leakage Detector		PRLDNVSO (R410a)	
EEV Kit		-	
Multi-tenant Power Module		PINPMB001	
Robot Cleaner		-	
Pre Filter (Washable)		○	
Ion Generator		-	
CO ₂ Sensor		-	
Ventilation Kit		-	
IR Receiver		-	
Zone Controller		-	
Dry Contact (with additional accessory)		PDRYCB000 (1 point contact), PDRYCB320, PDRYCB400 (2 points input), PDRYCB500 (Modbus)	
External Input (1 Point)		○	
Wi-Fi		PWFMDD200	
Human Detection Sensor		PTVSA00	
Floor Temperature Sensor		PTFSMA0	
Air Purification Kit		PTAHMP0 (PT-AFGW0 panel required)	
Elevation Grille		-	

High sensible

ARNU05GTAA4 / ARNU07GTAA4 / ARNU09GTAA4
ARNU12GTAA4 / ARNU15GTAA4 / ARNU18GTAA4



MODEL		UNIT	ARNU05GTAA4	ARNU07GTAA4	ARNU09GTAA4	ARNU12GTAA4	ARNU15GTAA4	ARNU18GTAA4
Cooling Capacity		kW	1.6	2.2	2.8	3.6	4.5	5.6
Heating Capacity		kW	1.8	2.5	3.2	4.0	5.0	6.3
Power Input (H / M / L)	Nominal	W	20 / 15 / 11	23 / 16 / 11	25 / 18 / 11	26 / 19 / 13	29 / 20 / 15	31 / 23 / 16
Dimensions (W x H x D)	Body	mm	840 x 288 x 840	840 x 288 x 840	840 x 288 x 840	840 x 288 x 840	840 x 288 x 840	840 x 288 x 840
	Shipping	mm	922 x 360 x 917	922 x 360 x 917	922 x 360 x 917	922 x 360 x 917	922 x 360 x 917	922 x 360 x 917
Fan	Type		Full 3D Turbo Fan	Full 3D Turbo Fan	Full 3D Turbo Fan	Full 3D Turbo Fan	Full 3D Turbo Fan	Full 3D Turbo Fan
	Motor Output x Number	W	166 x 1	166 x 1	166 x 1	166 x 1	166 x 1	166 x 1
	Running Current	A	0.21	0.23	0.25	0.25	0.27	0.28
	Air Flow Rate (H / M / L)	m ³ /min	18 / 15 / 13	19 / 16 / 13	19 / 16 / 13	20 / 17 / 15	20 / 17 / 15	21 / 19 / 16
	Motor Type		BLDC	BLDC	BLDC	BLDC	BLDC	BLDC
Air Filter			Pre Filter	Pre Filter	Pre Filter	Pre Filter	Pre Filter	Pre Filter
Pipe Connections	Liquid Side	mm (inch)	Ø9.52 (3/8)	Ø9.52 (3/8)	Ø9.52 (3/8)	Ø9.52 (3/8)	Ø9.52 (3/8)	Ø9.52 (3/8)
	Gas Side	mm (inch)	Ø15.88 (5/8)	Ø15.88 (5/8)	Ø15.88 (5/8)	Ø15.88 (5/8)	Ø15.88 (5/8)	Ø15.88 (5/8)
	Drain Pipe (Internal Dia.)	mm (inch)	Ø25 (1)	Ø25 (1)	Ø25 (1)	Ø25 (1)	Ø25 (1)	Ø25 (1)
Weight	Body	kg	26	27	27	27	27	27
Sound Pressure Level (H / M / L)		dB(A)	32 / 29 / 26	32 / 30 / 26	33 / 30 / 26	34 / 31 / 27	34 / 32 / 29	35 / 32 / 30
Sound Power Level (H / M / L)		dB(A)	40 / 37 / 36	41 / 38 / 36	42 / 39 / 36	42 / 40 / 37	43 / 40 / 38	44 / 41 / 38
Power Supply		Ø, V, Hz	1, 220-240, 50	1, 220-240, 50	1, 220-240, 50	1, 220-240, 50	1, 220-240, 50	1, 220-240, 50
Communication Cable (VCTF-SB)		mm ² x cores	1.0 - 1.5 x 2	1.0 - 1.5 x 2	1.0 - 1.5 x 2	1.0 - 1.5 x 2	1.0 - 1.5 x 2	1.0 - 1.5 x 2
Decoration Panel (Accessory)	Model Name		PT-AAGW0 PT-AFGW0	PT-AAGW0 PT-AFGW0	PT-AAGW0 PT-AFGW0	PT-AAGW0 PT-AFGW0	PT-AAGW0 PT-AFGW0	PT-AAGW0 PT-AFGW0
	Exterior Color		White	White	White	White	White	White
	RAL Code		RAL 9003	RAL 9003	RAL 9003	RAL 9003	RAL 9003	RAL 9003
	Net Dimensions (W x H x D)	mm	950 x 35 x 950	950 x 35 x 950	950 x 35 x 950	950 x 35 x 950	950 x 35 x 950	950 x 35 x 950
	Net Weight	kg	7.1 / 7.5	7.1 / 7.5	7.1 / 7.5	7.1 / 7.5	7.1 / 7.5	7.1 / 7.5

Note :

- Performance tested under EN14511
- Capacities are based on the following conditions
- Cooling : Indoor temp. 27°C (80.6°F) DB / 19°C (66.2°F) WB, Outdoor temp. 35°C (95°F) DB / 24°C (75.2°F) WB, Interconnecting piping length 7.5m, Level difference of zero
- Heating : Indoor temp. 20°C (68°F) DB / 15°C (59°F) WB, Outdoor temp. 7°C (44.6°F) DB / 6°C (42.8°F) WB, Interconnecting piping length 7.5m, Level difference of zero
- Due to our policy of innovation, some specifications may be changed without notification

Accessories

CHASSIS	ARNU05GTAA4	ARNU07GTAA4	ARNU09GTAA4	ARNU12GTAA4	ARNU15GTAA4	ARNU18GTAA4
Drain Pump				○		
Cassette Cover				PTDCA		
Refrigerant Leakage Detector				PRLDNVSO (R410a)		
EEV Kit				-		
Multi-tenant Power Module				PINPMB001		
Robot Cleaner				-		
Pre Filter (Washable)				○		
Ion Generator				-		
CO ₂ Sensor				-		
Ventilation Kit				-		
IR Receiver				-		
Zone Controller				-		
Dry Contact (with additional accessory)				PDRYCB000 (1 point contact), PDRYCB320, PDRYCB400 (2 points input), PDRYCB500 (Modbus)		
External Input (1 Point)				○		
Wi-Fi				PWFMDD200		
Human Detection Sensor				PTVSAAO		
Floor Temperature Sensor				PTFSMAO		
Air Purification Kit				PTAHMPO (PT-AFGW0 panel required)		
Elevation Grille				-		

High sensible

ARNU24GTAA4 / ARNU28GTAA4 / ARNU36GTAA4
ARNU42GTAA4 / ARNU48GTAA4



MODEL		UNIT	ARNU24GTAA4	ARNU28GTAA4	ARNU36GTAA4	ARNU42GTAA4	ARNU48GTAA4
Cooling Capacity		kW	7.1	8.2	10.6	12.3	14.1
Heating Capacity		kW	8.0	9.2	11.9	13.8	15.9
Power Input (H / M / L)	Nominal	W	40 / 31 / 25	46 / 35 / 26	65 / 43 / 31	86 / 65 / 43	100 / 67 / 53
	Body	mm	840 x 288 x 840	840 x 288 x 840	840 x 288 x 840	840 x 288 x 840	840 x 288 x 840
Dimensions (W x H x D)	Shipping	mm	922 x 360 x 917	922 x 360 x 917	922 x 360 x 917	922 x 360 x 917	922 x 360 x 917
	Type		Full 3D Turbo Fan	Full 3D Turbo Fan	Full 3D Turbo Fan	Full 3D Turbo Fan	Full 3D Turbo Fan
Fan	Motor Output x Number	W	166 x 1	166 x 1	166 x 1	166 x 1	166 x 1
	Running Current	A	0.38	0.46	0.60	0.80	0.88
	Air Flow Rate (H / M / L)	m³/min	23 / 21 / 19	24 / 22 / 20	28 / 24 / 21	31 / 28 / 24	33 / 28 / 26
	Motor Type		BLDC	BLDC	BLDC	BLDC	BLDC
Air Filter			Pre Filter	Pre Filter	Pre Filter	Pre Filter	Pre Filter
Pipe Connections	Liquid Side	mm (inch)	Ø9.52 (3/8)	Ø9.52 (3/8)	Ø9.52 (3/8)	Ø9.52 (3/8)	Ø9.52 (3/8)
	Gas Side	mm (inch)	Ø15.88 (5/8)	Ø15.88 (5/8)	Ø15.88 (5/8)	Ø15.88 (5/8)	Ø15.88 (5/8)
	Drain Pipe (Internal Dia.)	mm (inch)	Ø25 (1)	Ø25 (1)	Ø25 (1)	Ø25 (1)	Ø25 (1)
Weight	Body	kg	27	27	27	27	27
Sound Pressure Level (H / M / L)		dB(A)	39 / 36 / 33	40 / 37 / 34	42 / 39 / 35	46 / 42 / 39	47 / 43 / 41
Sound Power Level (H / M / L)		dB(A)	47 / 45 / 42	48 / 46 / 42	51 / 48 / 44	54 / 51 / 48	56 / 52 / 50
Power Supply		Ø, V, Hz	1, 220-240, 50	1, 220-240, 50	1, 220-240, 50	1, 220-240, 50	1, 220-240, 50
Communication Cable (VCTF-SB)		mm² x cores	1.0 - 1.5 x 2	1.0 - 1.5 x 2	1.0 - 1.5 x 2	1.0-1.5 x 2	1.0 - 1.5 x 2
Decoration Panel (Accessory)	Model Name		PT-AAGW0 PT-AFGW0	PT-AAGW0 PT-AFGW0	PT-AAGW0 PT-AFGW0	PT-AAGW0 PT-AFGW0	PT-AAGW0 PT-AFGW0
	Exterior Color		White	White	White	White	White
	RAL Code		RAL 9003	RAL 9003	RAL 9003	RAL 9003	RAL 9003
	Net Dimensions (W x H x D)	mm	950 x 35 x 950	950 x 35 x 950	950 x 35 x 950	950 x 35 x 950	950 x 35 x 950
	Net Weight	kg	7.1 / 7.5	7.1 / 7.5	7.1 / 7.5	7.1 / 7.5	7.1 / 7.5

Note :
 1. Performance tested under EN14511
 2. Capacities are based on the following conditions
 - Cooling : Indoor temp. 27°C (80.6°F) DB / 19°C (66.2°F) WB, Outdoor temp. 35°C (95°F) DB / 24°C (75.2°F) WB, Interconnecting piping length 7.5m, Level difference of zero
 - Heating : Indoor temp. 20°C (68°F) DB / 15°C (59°F) WB, Outdoor temp. 7°C (44.6°F) DB / 6°C (42.8°F) WB, Interconnecting piping length 7.5m, Level difference of zero
 3. Due to our policy of innovation, some specifications may be changed without notification

Accessories

CHASSIS	ARNU24GTAA4	ARNU28GTAA4	ARNU36GTAA4	ARNU42GTAA4	ARNU48GTAA4
Drain Pump			○		
Cassette Cover			PTDCA		
Refrigerant Leakage Detector			PRLDNV50 (R410a)		
EEV Kit			-		
Multi-tenant Power Module			PINPMB001		
Robot Cleaner			-		
Pre Filter (Washable)			○		
Ion Generator			-		
CO ₂ Sensor			-		
Ventilation Kit			-		
IR Receiver			-		
Zone Controller			-		
Dry Contact (with additional accessory)			PDRYCB000 (1 point contact), PDRYCB320, PDRYCB400 (2 points input), PDRYCB500 (Modbus)		
External Input (1 Point)			○		
Wi-Fi			PWFMDD200		
Human Detection Sensor			PTVSA00		
Floor Temperature Sensor			PTFSMA0		
Air Purification Kit			PTAHMPO (PT-AFGW0 panel required)		
Elevation Grille			-		

**ARNU05GTRB4 / ARNU07GTRB4
ARNU09GTRB4 / ARNU12GTRB4**



MODEL		UNIT	ARNU05GTRB4	ARNU07GTRB4	ARNU09GTRB4	ARNU12GTRB4
Cooling Capacity		kW	1.6	2.2	2.8	3.6
Heating Capacity		kW	1.8	2.5	3.2	4.0
Power Input (H / M / L)	Nominal	W	13 / 12 / 11	13 / 12 / 11	14 / 13 / 12	17 / 15 / 13
	Body	mm	570 x 214 x 570	570 x 214 x 570	570 x 214 x 570	570 x 214 x 570
Dimensions (W x H x D)	Shipping	mm	667 x 285 x 646	667 x 285 x 646	667 x 285 x 646	667 x 285 x 646
	Type		Turbo Fan	Turbo Fan	Turbo Fan	Turbo Fan
Fan	Motor Output x Number	W	43 x 1	43 x 1	43 x 1	43 x 1
	Air Flow Rate (H / M / L)	m³/min	7.5 / 7.0 / 6.6	7.5 / 7.0 / 6.6	8.0 / 7.5 / 7.1	8.7 / 8.0 / 7.0
	Motor Type		BLDC	BLDC	BLDC	BLDC
Air Filter			Pre Filter	Pre Filter	Pre Filter	Pre Filter
Pipe Connections	Liquid Side	mm (inch)	Ø6.35 (1/4)	Ø6.35 (1/4)	Ø6.35 (1/4)	Ø6.35 (1/4)
	Gas Side	mm (inch)	Ø12.7 (1/2)	Ø12.7 (1/2)	Ø12.7 (1/2)	Ø12.7 (1/2)
	Drain Pipe (Internal Dia.)	mm (inch)	Ø25 (1)	Ø25 (1)	Ø25 (1)	Ø25 (1)
Weight	Body	kg	12.6	12.6	13.7	13.7
Sound Pressure Levels (H / M / L)		dB(A)	29 / 27 / 26	29 / 27 / 26	30 / 29 / 27	32 / 30 / 27
Sound Power Levels (H / M / L)		dB(A)	47 / 46 / 45	47 / 46 / 45	48 / 46 / 45	51 / 48 / 45
Power Supply		Ø, V, Hz	1, 220-240, 50	1, 220-240, 50	1, 220-240, 50	1, 220-240, 50
Transmission Cable		mm²	1.0 ~ 1.5 x 2C	1.0 ~ 1.5 x 2C	1.0 ~ 1.5 x 2C	1.0 ~ 1.5 x 2C
Decoration Panel (Accessory)	Model Name		PT-QAGW0	PT-QAGW0	PT-QAGW0	PT-QAGW0
	Exterior Color		White	White	White	White
	RAL Code		RAL 9001	RAL 9001	RAL 9001	RAL 9001
	Net Dimensions (W x H x D)	mm	620 x 35 x 620	620 x 35 x 620	620 x 35 x 620	620 x 35 x 620
	Net Weight	kg	3.2 / 3.0 / 2.9	3.2 / 3.0 / 2.9	3.2 / 3.0 / 2.9	3.2 / 3.0 / 2.9

Note :

1. Performance tested under EN14511

2. Capacities are based on the following conditions

- Cooling : Indoor temp. 27°C (80.6°F) DB / 19°C (66.2°F) WB, Outdoor temp. 35°C (95°F) DB / 24°C (75.2°F) WB, Interconnecting piping length 7.5m, Level difference of zero

- Heating : Indoor temp. 20°C (68°F) DB / 15°C (59°F) WB, Outdoor temp. 7°C (44.6°F) DB / 6°C (42.8°F) WB, Interconnecting piping length 7.5m, Level difference of zero

3. Due to our policy of innovation, some specifications may be changed without notification

Accessories

CHASSIS	ARNU05GTRB4	ARNU07GTRB4	ARNU09GTRB4	ARNU12GTRB4
Drain Pump			○	
Cassette Cover			-	
Refrigerant Leakage Detector		PRLDNVSO (R410a)		
EEV Kit		PRGK024A0 (~4.5kW)		
Multi-tenant Power Module		PINPMB001		
Robot Cleaner		-		
Pre Filter (Washable)			○	
Ion Generator			-	
CO ₂ Sensor			-	
Ventilation Kit		PTVK430		
IR Receiver			-	
Zone Controller			-	
Dry Contact (with additional accessory)		PDRYCB000 (1 point contact), PDRYCB320, PDRYCB400 (2 points input), PDRYCB500 (Modbus)		
External Input (1 point)			○	
Wi-Fi		PWFMDD200		

※ ○ : Applied, - : Not applied

Option : Refer to model name in table

ARNU15GTQB4 / ARNU18GTQB4 ARNU21GTQB4



MODEL		UNIT	ARNU15GTQB4	ARNU18GTQB4	ARNU21GTQB4
Cooling Capacity		kW	4.5	5.6	6.0
Heating Capacity		kW	5.0	6.3	6.8
Power Input (H / M / L)	Nominal	W	24 / 21 / 18	25 / 22 / 19	28 / 23 / 20
Dimensions (W x H x D)	Body	mm	570 x 256 x 570	570 x 256 x 570	570 x 256 x 570
	Shipping	mm	667 x 327 x 646	667 x 327 x 646	667 x 327 x 646
Fan	Type		Turbo Fan	Turbo Fan	Turbo Fan
	Motor Output x Number	W	43 x 1	43 x 1	43 x 1
	Air Flow Rate (H / M / L)	m ³ /min	11.0 / 10.0 / 9.3	11.2 / 11.0 / 10.0	12.0 / 11.1 / 9.4
	Motor Type		BLDC	BLDC	BLDC
Air Filter			Pre Filter	Pre Filter	Pre Filter
Pipe Connections	Liquid Side	mm (inch)	Ø6.35 (1/4)	Ø6.35 (1/4)	Ø9.52 (3/8)
	Gas Side	mm (inch)	Ø12.7 (1/2)	Ø12.7 (1/2)	Ø15.88 (5/8)
	Drain Pipe (Internal Dia.)	mm (inch)	Ø25 (1)	Ø25 (1)	Ø25 (1)
Weight	Body	kg	15.0	15.0	15.0
Sound Pressure Levels (H / M / L)		dB(A)	36 / 34 / 32	37 / 35 / 34	40 / 38 / 34
Sound Power Levels (H / M / L)		dB(A)	52 / 50 / 46	52 / 50 / 46	54 / 52 / 46
Power Supply		Ø, V, Hz	1, 220-240, 50	1, 220-240, 50	1, 220-240, 50
Transmission Cable		mm ²	1.0 - 1.5 x 2C	1.0 - 1.5 x 2C	1.0 - 1.5 x 2C
Decoration Panel (Accessory)	Model Name		PT-QAGW0	PT-QAGW0	PT-QAGW0
	Exterior Color		White	White	White
	RAL Code		RAL 9001	RAL 9001	RAL 9001
	Net Dimensions (W x H x D)	mm	620 x 35 x 620	620 x 35 x 620	620 x 35 x 620
	Net Weight	kg	3.2 / 3.0 / 2.9	3.2 / 3.0 / 2.9	3.2 / 3.0 / 2.9

Note :

1. Performance tested under EN14511

2. Capacities are based on the following conditions

- Cooling : Indoor temp. 27°C (80.6°F) DB / 19°C (66.2°F) WB, Outdoor temp. 35°C (95°F) DB / 24°C (75.2°F) WB, Interconnecting piping length 7.5m, Level difference of zero

- Heating : Indoor temp. 20°C (68°F) DB / 15°C (59°F) WB, Outdoor temp. 7°C (44.6°F) DB / 6°C (42.8°F) WB, Interconnecting piping length 7.5m, Level difference of zero

3. Due to our policy of innovation, some specifications may be changed without notification

Accessories

CHASSIS	ARNU15GTQB4	ARNU18GTQB4	ARNU21GTQB4
Drain Pump		○	
Cassette Cover		-	
Refrigerant Leakage Detector		PRLDNV50 (R410a)	
EEV Kit		PRGK024A0 (-4.5kW)	
Multi-tenant Power Module		PINPMB001	
Robot Cleaner		-	
Pre Filter (Washable)		○	
Ion Generator		-	
CO ₂ Sensor		-	
Ventilation Kit		PTVK430	
IR Receiver		-	
Zone Controller		-	
Dry Contact (with additional accessory)		PDRYCB000 (1 point contact), PDRYCB320, PDRYCB400 (2 points input), PDRYCB500 (Modbus)	
External Input (1 point)		○	
Wi-Fi		PWFMDD200	

※ ○ : Applied, - : Not applied

Option : Refer to model name in table

ARNU09GTSC4 / ARNU12GTSC4



MODEL	UNIT	ARNU09GTSC4	ARNU12GTSC4
Cooling Capacity	kW	2.8	3.6
Heating Capacity	kW	3.2	4.0
Power Input (H / M / L)	Nominal W	16 / 14 / 11	18 / 14 / 11
Dimensions (W x H x D)	Body	830 x 225 x 600	830 x 225 x 600
	Shipping	1,055 x 290 x 682	1,055 x 290 x 682
Fan	Type	Turbo Fan	Turbo Fan
	Motor Output x Number	W x No.	37 x 1
	Air Flow Rate (H / M / L)	m ³ /min	10.8 / 9.8 / 9.1
	Motor Type	BLDC	BLDC
Air Filter		Pre Filter	Pre Filter
Pipe Connections	Liquid Side	mm (inch)	Ø6.35 (1/4)
	Gas Side	mm (inch)	Ø12.7 (1/2)
	Drain Pipe (Internal Dia.)	mm (inch)	Ø25 (1)
Weight	Body	kg	18.1
Sound Pressure Levels (H / M / L)		dB(A)	33 / 31 / 29
Sound Power Levels (H / M / L)		dB(A)	44 / 41 / 40
Power Supply		Ø, V, Hz	1, 220-240, 50
Communication Cable		mm ²	1.0 - 1.5 x 2C
Decoration Panel (Accessory)	Model Name		PT-USC
	Exterior Color		Morning Fog
	RAL Code		RAL 9001
	Net Dimensions (W x H x D)	mm	1,100 x 28 x 690
	Net Weight	kg	4.7

Note:

1. Performance tested under EN14511

2. Capacities are based on the following conditions

- Cooling: Indoor temp. 27°C (80.6°F) DB / 19°C (66.2°F) WB, Outdoor temp. 35°C (95°F) DB / 24°C (75.2°F) WB, Interconnecting piping length 7.5m, Level difference of zero

- Heating: Indoor temp. 20°C (68°F) DB / 15°C (59°F) WB, Outdoor temp. 7°C (44.6°F) DB / 6°C (42.8°F) WB, Interconnecting piping length 7.5m, Level difference of zero

3. Due to our policy of innovation, some specifications may be changed without notification

Accessories

CHASSIS	ARNU09GTSC4	ARNU12GTSC4
Drain Pump		○
Cassette Cover		-
Refrigerant Leakage Detector		PRLDNVSO (R410a)
EEV Kit		PRGK024A0 (-5.6kW)
Multi-tenant Power Module		PINPMB001
Robot Cleaner		-
Pre Filter (Washable)		○
Ion Generator		-
CO ₂ Sensor		-
Ventilation Kit		-
IR Receiver		-
Zone Controller		-
Dry Contact (with additional accessory)		PDRYCB000 (1 point contact), PDRYCB320, PDRYCB400 (2 points input), PDRYCB500 (Modbus)
External Input (1 point)		○
Wi-Fi		PWFMD200

※ ○ : Applied, - : Not applied

Option : Refer to model name in table

ARNU18GTSC4 / ARNU24GTSC4



MODEL	UNIT	ARNU18GTSC4	ARNU24GTSC4
Cooling Capacity	kW	5.6	7.1
Heating Capacity	kW	6.3	8.0
Power Input (H / M / L)	Nominal W	19 / 16 / 14	31 / 22 / 14
Dimensions (W x H x D)	Body	mm	830 x 225 x 600
	Shipping	mm	1,055 x 290 x 682
Fan	Type		Turbo Fan
	Motor Output x Number	W x No.	37 x 1
	Air Flow Rate (H / M / L)	m ³ /min	11.8 / 10.8 / 9.8
	Motor Type		BLDC
Air Filter		Pre Filter	Pre Filter
Pipe Connections	Liquid Side	mm (inch)	Ø6.35 (1/4)
	Gas Side	mm (inch)	Ø12.7 (1/2)
	Drain Pipe (Internal Dia.)	mm (inch)	Ø25 (1)
Weight	Body	kg	18.1
Sound Pressure Levels (H / M / L)		dB(A)	35 / 33 / 31
Sound Power Levels (H / M / L)		dB(A)	45 / 44 / 41
Power Supply		Ø, V, Hz	1, 220-240, 50
Communication Cable		mm ²	1.0 ~ 1.5 x 2C
Decoration Panel (Accessory)	Model Name		PT-USC
	Exterior Color		Morning Fog
	RAL Code		RAL 9001
	Net Dimensions (W x H x D)	mm	1,100 x 28 x 690
	Net Weight	kg	4.7

Note :

1. Performance tested under EN14511

2. Capacities are based on the following conditions

- Cooling : Indoor temp. 27°C (80.6°F) DB / 19°C (66.2°F) WB, Outdoor temp. 35°C (95°F) DB / 24°C (75.2°F) WB, Interconnecting piping length 7.5m, Level difference of zero

- Heating : Indoor temp. 20°C (68°F) DB / 15°C (59°F) WB, Outdoor temp. 7°C (44.6°F) DB / 6°C (42.8°F) WB, Interconnecting piping length 7.5m, Level difference of zero

3. Due to our policy of innovation, some specifications may be changed without notification

Accessories

Chassis	ARNU18GTSC4	ARNU24GTSC4
Drain Pump		○
Cassette Cover		-
Refrigerant Leakage Detector		PRLDNV50 (R410a)
EEV Kit		PRGK024A0 (-5.6kW)
Multi-tenant Power Module		PINPMB001
Robot Cleaner		-
Pre Filter (Washable)		○
Ion Generator		-
CO ₂ Sensor		-
Ventilation Kit		-
IR Receiver		-
Zone Controller		-
Dry Contact (with additional accessory)		PDRYCB000 (1 point contact), PDRYCB320, PDRYCB400 (2 points input), PDRYCB500 (Modbus)
External Input (1 point)		○
Wi-Fi		PWFMDD200

※ ○ : Applied, - : Not applied

Option : Refer to model name in table

**ARNU07GTUB4 / ARNU09GTUB4
ARNU12GTUB4**



MODEL		UNIT	ARNU07GTUB4	ARNU09GTUB4	ARNU12GTUB4
Cooling Capacity		kW	2.2	2.8	3.6
Heating Capacity		kW	2.5	3.2	4.0
Power Input (H / M / L)	Nominal	W	20 / 18 / 16	22 / 20 / 18	24 / 22 / 20
Dimensions (W x H x D)	Body	mm	860 x 132 x 450	860 x 132 x 450	860 x 132 x 450
	Shipping	mm	1,129 x 259 x 538	1,129 x 259 x 538	1,129 x 259 x 538
Fan	Type		Cross Flow Fan	Cross Flow Fan	Cross Flow Fan
	Motor Output x Number	W x No.	30 x 1	30 x 1	30 x 1
	Air Flow Rate (H / M / L)	m ³ /min	8.2 / 7.3 / 6.4	9.2 / 8.6 / 8.2	10.0 / 9.2 / 8.2
	Motor Type		BLDC	BLDC	BLDC
Air Filter			Pre Filter	Pre Filter	Pre Filter
Pipe Connections	Liquid Side	mm (inch)	Ø6.35 (1/4)	Ø6.35 (1/4)	Ø6.35 (1/4)
	Gas Side	mm (inch)	Ø12.7 (1/2)	Ø12.7 (1/2)	Ø12.7 (1/2)
	Drain Pipe (Internal Dia.)	mm (inch)	Ø25 (1)	Ø25 (1)	Ø25 (1)
Weight	Body	kg	12.2	12.2	12.2
Sound Pressure Levels (H / M / L)		dB(A)	32 / 29 / 25	35 / 34 / 32	38 / 35 / 32
Sound Power Levels (H / M / L)		dB(A)	47 / 44 / 41	51 / 49 / 47	52 / 51 / 47
Power Supply		Ø, V, Hz	1, 220-240, 50	1, 220-240, 50	1, 220-240, 50
Transmission Cable		mm ²	1.0 ~ 1.5 x 2C	1.0 ~ 1.5 x 2C	1.0 ~ 1.5 x 2C
Decoration Panel (Accessory)	Model Name		PT-UAHGO, PT-UAHWO, PT-UPHGO	PT-UAHGO, PT-UAHWO, PT-UPHGO	PT-UAHGO, PT-UAHWO, PT-UPHGO
	Exterior Color		Noble White	Noble White	Noble White
	RAL Code		RAL 9003	RAL 9003	RAL 9003
	Net Dimensions (W x H x D)	mm	1,160 x 34 x 500 1,100 x 34 x 500 1,160 x 34 x 500	1,160 x 34 x 500 1,100 x 34 x 500 1,160 x 34 x 500	1,160 x 34 x 500 1,100 x 34 x 500 1,160 x 34 x 500
	Net Weight	kg	3.9 / 3.3 / 4.1	3.9 / 3.3 / 4.1	3.9 / 3.3 / 4.1

Note :

- Performance tested under EN14511
- Capacities are based on the following conditions
 - Cooling : Indoor temp. 27°C (80.6°F) DB / 19°C (66.2°F) WB, Outdoor temp. 35°C (95°F) DB / 24°C (75.2°F) WB, Interconnecting piping length 7.5m, Level difference of zero
 - Heating : Indoor temp. 20°C (68°F) DB / 15°C (59°F) WB, Outdoor temp. 7°C (44.6°F) DB / 6°C (42.8°F) WB, Interconnecting piping length 7.5m, Level difference of zero
- Due to our policy of innovation, some specifications may be changed without notification

Accessories

CHASSIS	ARNU07GTUB4	ARNU09GTUB4	ARNU12GTUB4
Drain Pump		○	
Cassette Cover		-	
Refrigerant Leakage Detector		PRLDNVSO (R410a)	
EEV Kit		PRGK024A0	
Multi-tenant Power Module		PINPMB001	
Robot Cleaner		-	
Pre Filter (Washable)		○	
Ion Generator		-	
CO ₂ Sensor		-	
Ventilation Kit		-	
IR Receiver		-	
Zone Controller		-	
Dry Contact (with additional accessory)		PDRYCB000 (1 point contact), PDRYCB320, PDRYCB400 (2 points input), PDRYCB500 (Modbus)	
External Input (1 point)		○	
Air Purification Kit		PTAHTPO	
Wi-Fi		PWFMD200	

※ ○ : Applied, - : Not applied
Option : Refer to model name in table

ARNU18GTTB4 / ARNU24GTTB4



MODEL	UNIT	ARNU18GTTB4	ARNU24GTTB4
Cooling Capacity	kW	5.6	7.1
Heating Capacity	kW	6.3	7.1
Power Input (H / M / L)	Nominal W	38 / 28 / 24	51 / 33 / 26
Dimensions (W x H x D)	Body	mm	1,180 x 132 x 450
	Shipping	mm	1,499 x 259 x 538
Fan	Type		Cross Flow Fan
	Motor Output x Number	W x No.	30 x 1
	Air Flow Rate (H / M / L)	m³/min	13.3 / 12.1 / 10.9
	Motor Type		BLDC
Air Filter		Pre Filter	Pre Filter
Pipe Connections	Liquid Side	mm (inch)	Ø6.35 (1/4)
	Gas Side	mm (inch)	Ø12.7 (1/2)
	Drain Pipe (Internal Dia.)	mm (inch)	Ø25 (1)
Weight	Body	kg	15.6
Sound Pressure Levels (H / M / L)		dB(A)	40 / 37 / 35
Sound Power Levels (H / M / L)		dB(A)	55 / 51 / 47
Power Supply		Ø, V, Hz	1, 220-240, 50
Transmission Cable		mm²	1.0 ~ 1.5 x 2C
Decoration Panel (Accessory)	Model Name		PT-TAHG0, PT-TAHW0, PT-TPHG0
	Exterior Color		Noble White
	RAL Code		RAL 9003
	Net Dimensions (W x H x D)	mm	1,480 x 34 x 500
	Net Weight	kg	4.8 / 4.5 / 4.9

Note :

- Performance tested under EN14511
- Capacities are based on the following conditions
 - Cooling : Indoor temp. 27°C (80.6°F) DB / 19°C (66.2°F) WB, Outdoor temp. 35°C (95°F) DB / 24°C (75.2°F) WB, Interconnecting piping length 7.5m, Level difference of zero
 - Heating : Indoor temp. 20°C (68°F) DB / 15°C (59°F) WB, Outdoor temp. 7°C (44.6°F) DB / 6°C (42.8°F) WB, Interconnecting piping length 7.5m, Level difference of zero
- Due to our policy of innovation, some specifications may be changed without notification

Accessories

CHASSIS	ARNU18GTTB4	ARNU24GTTB4
Drain Pump		○
Cassette Cover		-
Refrigerant Leakage Detector		PRLDNV50 (R410a)
EEV Kit		-
Multi-tenant Power Module		PINPMB001
Robot Cleaner		-
Pre Filter (Washable)		○
Ion Generator		-
CO ₂ Sensor		-
Ventilation Kit		-
IR Receiver		-
Zone Controller		-
Dry Contact (with additional accessory)		PDRYCB000 (1 point contact), PDRYCB320, PDRYCB400 (2 points input), PDRYCB500 (Modbus)
External Input (1 point)		○
Air Purification Kit		PTAHTP0
Wi-Fi		PWFMDD200

※ ○ : Applied, - : Not applied
Option : Refer to model name in table

CEILING MOUNTED ROUND CASSETTE



Features & Benefits

- Luxury round design can make a luxurious space with a round design considering side view.
- Perfect round air flow without blind spots.

Key Applications

- Retail
- Office
- Restaurant
- Hotel

	CASSETTE	ROUND
Smart	Wi-Fi	○
Energy Efficiency	Human Detect Sensor	-
	Drain Pump	○
	Sleep Mode	○
Comfort	Timer (On / Off)	○
	Timer (Weekly)	○
	Two Thermistor Control	○
	Group Control	○

※ ○: Applied, - : Not applied

Slim and Compact Design

Reduce the height of the body by 15%, save space and maximize the openness of the interior space.

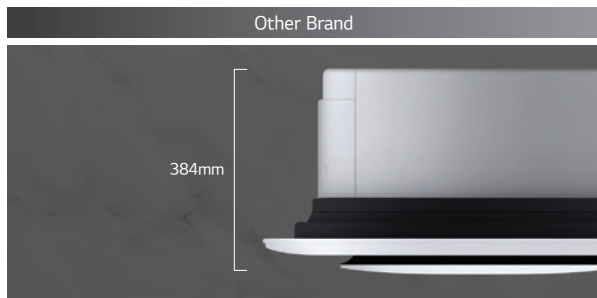

※ Product : 48 kBtu



15% less body height makes room more higher

Minimal Exposure Design

Pipes are brought together in one place to minimize exposure. Hanger covers hide installations to add a clean look.

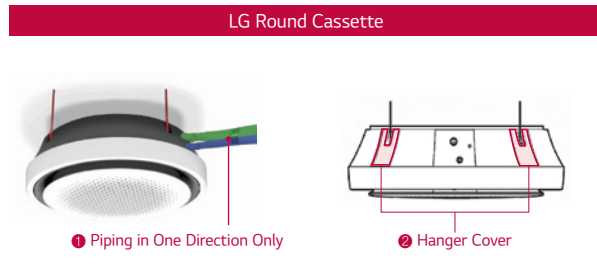
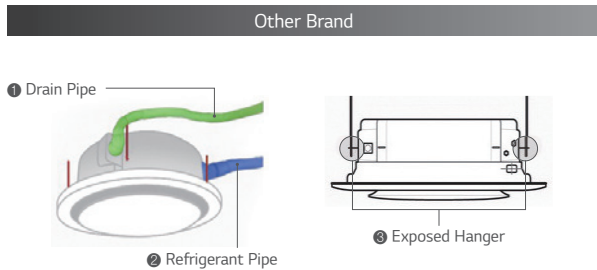

Perfect Round Air Flow

Perfect round flow without blind spots.

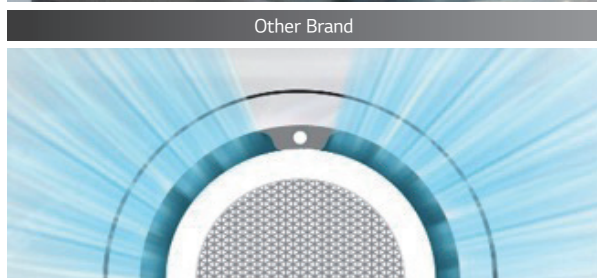

3 Way airflow with blind spot.



Perfect circular airflow without blind spots.

Visible Air Flow

With crystal vein for 6-step precision control, you can send cool / heated air wherever you want.

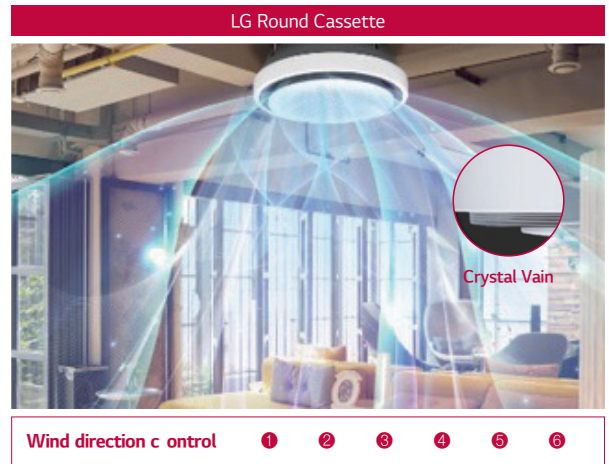
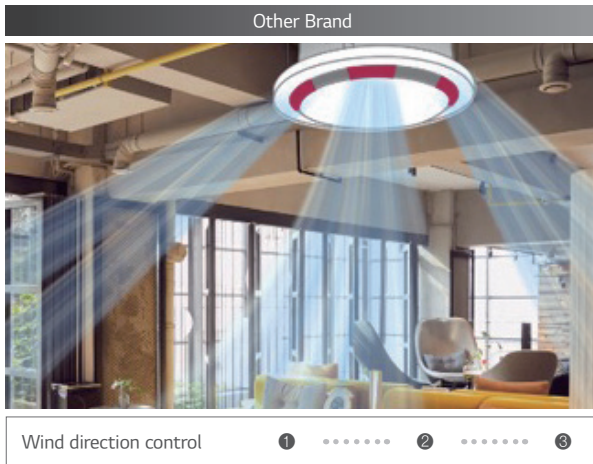

Powerful and Quiet Air Flow

3D fan increases airflow by 5% and noise reduction technology makes a quieter, more comfortable space.

Full 3D Fan, Air flow rate 5% ↑

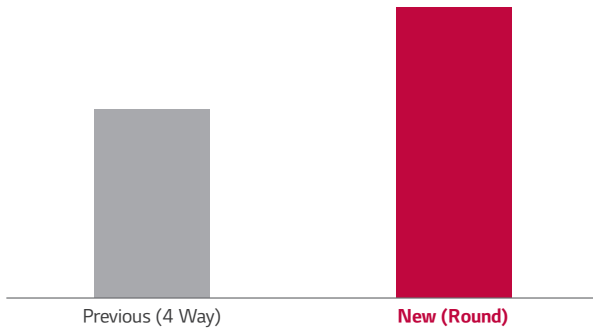

Full 3D Fan, Low noise

※ 48 kBtu, Low flow rate

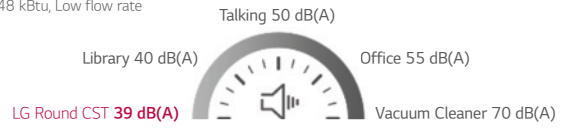

30% Faster in Cooling

Larger airflow rate, cooling rate is faster than 30%.

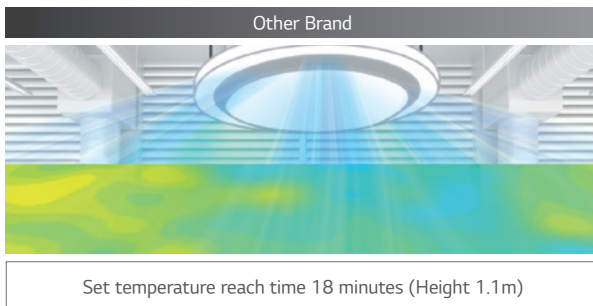

※ Based on test results from LG chamber, this image is designed to help customers understand. Experimental environment: height 3.2m, 48 kBtu, cooling mode, high flow rate, horizontal air flow direction

ARNU24GTYA4 / ARNU36GTYA4 / ARNU48GTYA4



MODEL		UNIT	ARNU24GTYA4	ARNU36GTYA4	ARNU48GTYA4
Cooling Capacity		kW	7.1	10.6	14.1
Heating Capacity		kW	8.0	11.9	15.9
Power Input (H / M / L)	Nominal	W	44 / 36 / 29	63 / 47 / 36	98 / 70 / 44
Dimensions (W x H x D)	Body	mm	1,050 x 330 x 1,050	1,050 x 330 x 1,050	1,050 x 330 x 1,050
	Shipping	mm	1,137 x 395 x 1,132	1,137 x 395 x 1,132	1,137 x 395 x 1,132
Fan	Type		3D Turbo Fan	3D Turbo Fan	3D Turbo Fan
	Motor Output x Number	W	157 x 1	157 x 1	157 x 1
	Air Flow Rate (H / M / L)	m ³ /min	22 / 21 / 19	27 / 24 / 21	32 / 28 / 23
	Motor Type		BLDC	BLDC	BLDC
Air Filter			Long life	Long life	Long life
Pipe Connections	Liquid Side	mm (inch)	Ø9.52 (3/8)	Ø9.52 (3/8)	Ø9.52 (3/8)
	Gas Side	mm (inch)	Ø15.88 (5/8)	Ø15.88 (5/8)	Ø15.88 (5/8)
	Drain Pipe(Internal Dia.)	mm (inch)	Ø25 (1)	Ø25 (1)	Ø25 (1)
Weight	Body	kg	30	30	30
Sound Pressure Level (H / M / L)		dB(A)	39 / 37 / 34	43 / 39 / 37	47 / 44 / 39
Sound Power Level (H / M / L)		dB(A)	48 / 46 / 43	52 / 48 / 46	56 / 53 / 48
Power Supply		Ø, V, Hz	1, 220-240, 50	1, 220-240, 50	1, 220-240, 50
Communication Cable (VCTF-SB)		mm ² x cores	1.0 - 1.5 x 2C	1.0 - 1.5 x 2C	1.0 - 1.5 x 2C

Note :

1. Performance tested under EN14511

2. Capacities are based on the following conditions

- Cooling : Indoor temp. 27°C (80.6°F) DB / 19°C (66.2°F) WB, Outdoor temp. 35°C (95°F) DB / 24°C (75.2°F) WB, Interconnecting piping length 7.5m, Level difference of zero

- Heating : Indoor temp. 20°C (68°F) DB / 15°C (59°F) WB, Outdoor temp. 7°C (44.6°F) DB / 6°C (42.8°F) WB, Interconnecting piping length 7.5m, Level difference of zero

3. Due to our policy of innovation, some specifications may be changed without notification

Accessories

CHASSIS	ARNU24GTYA4	ARNU36GTYA4	ARNU48GTYA4
Drain Pump		○	
Cassette Cover		-	
Refrigerant Leakage Detector		PRLDNVSO (R410a)	
EEV Kit		-	
Multi-tenant Power Module		PINPMB001	
Robot Cleaner		-	
Pre Filter (Washable)		○	
Ion Generator		-	
CO ₂ Sensor		-	
Ventilation Kit		-	
IR Receiver		-	
Zone Controller		-	
Dry Contact (with additional accessory)		PDRYCB000 (1 point contact), PDRYCB320, PDRYCB400 (2 points input), PDRYCB500 (Modbus)	
External Input (1 Point)		○	
Wi-Fi		PWFMDD200	
Human Detection Sensor		-	
Floor Temperature Sensor		-	
Air Purification Kit		PTAHYPO	
Elevation Grille		-	

※ ○ : Applied, - : Not applied

Option : Refer to model name in table



Features & Benefits

- Easy and flexible duct adjusts air volume with External Static Pressure (ESP) control function.
- Minimalist visibility (Hidden within ceiling) to blend seamlessly into any interior

Key Applications

- Office
- Hotel
- Retail
- Residential building

	DUCT	HIGH	MIDDLE	LOW
Smart	Wi-Fi	○	○	○
Energy Efficiency	E.S.P Control	○	○	○
	Drain Pump	○	○	○
Comfort	Timer (On / Off)	○	○	○
	Timer (Weekly)	○	○	○
	Two Thermistor Control	○	○	○
	Group Control	○	○	○

※ ○: Applied, - : Not applied

Wi-Fi Control

Anytime, anywhere access to the unit with Android & iOS-based smartphones.

ThinQ

Search "ThinQ" on Google market or the App Store to download the app.

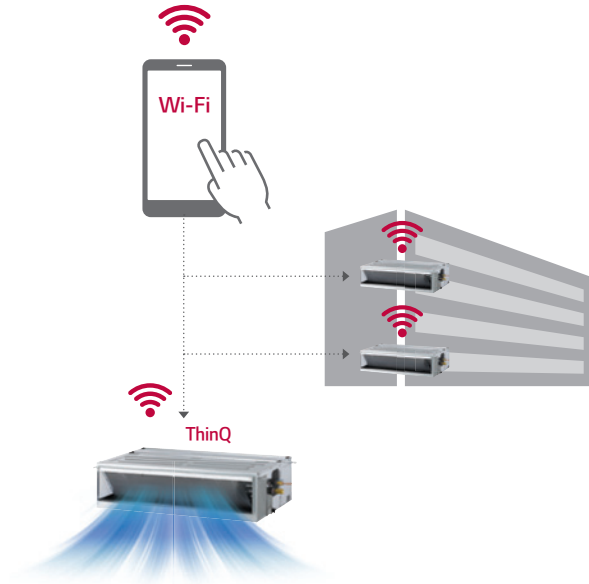

Easy Registration and Log-in

Follow the easy set-up steps that will activate ThinQ's user-friendly features.

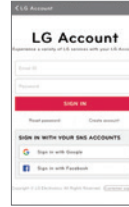

Simple operation for various functions



On / Off, Current Temp



Mode, Set Temp



Zone Control

※ For our policy of continuous ThinQ App improvement, specification, design and features are subject to change without prior notice.

External Static Pressure (ESP) Control

User has easy access to air volume selection via remote controller using the ESP control function. The BLDC motor can control fan speed and air volume. No additional accessories are necessary to control air flow.

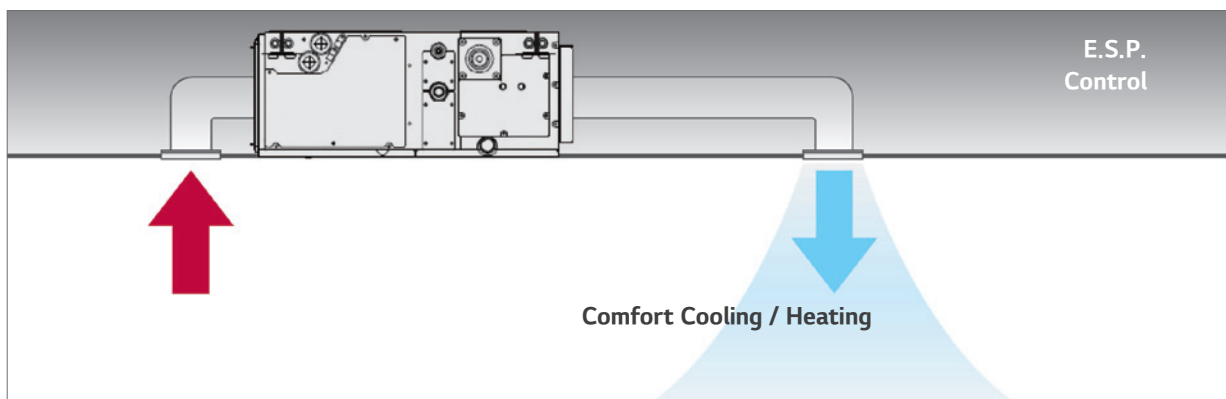
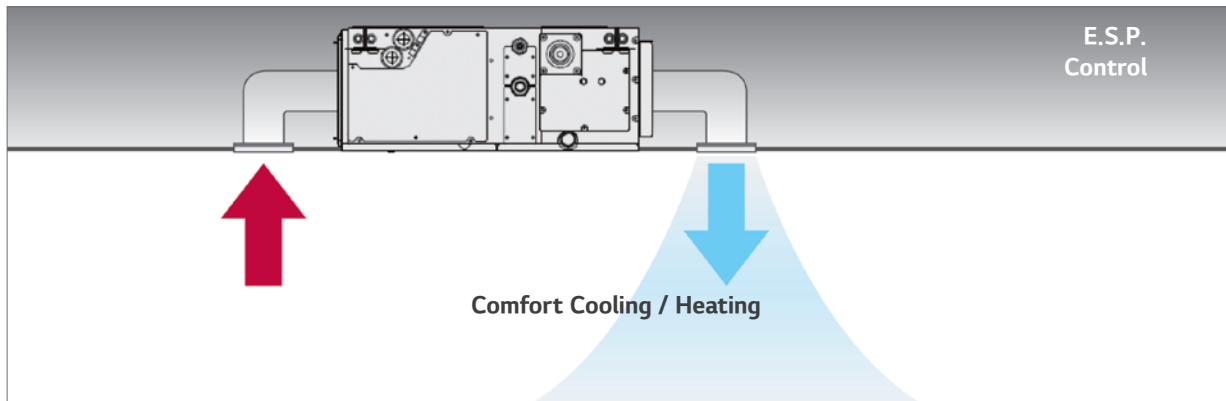

Static Pressure 11- Step Control

Depending on the installation environment, LG's ceiling concealed duct controls the static pressure with 11 steps to provide maximized comfort to any environment.

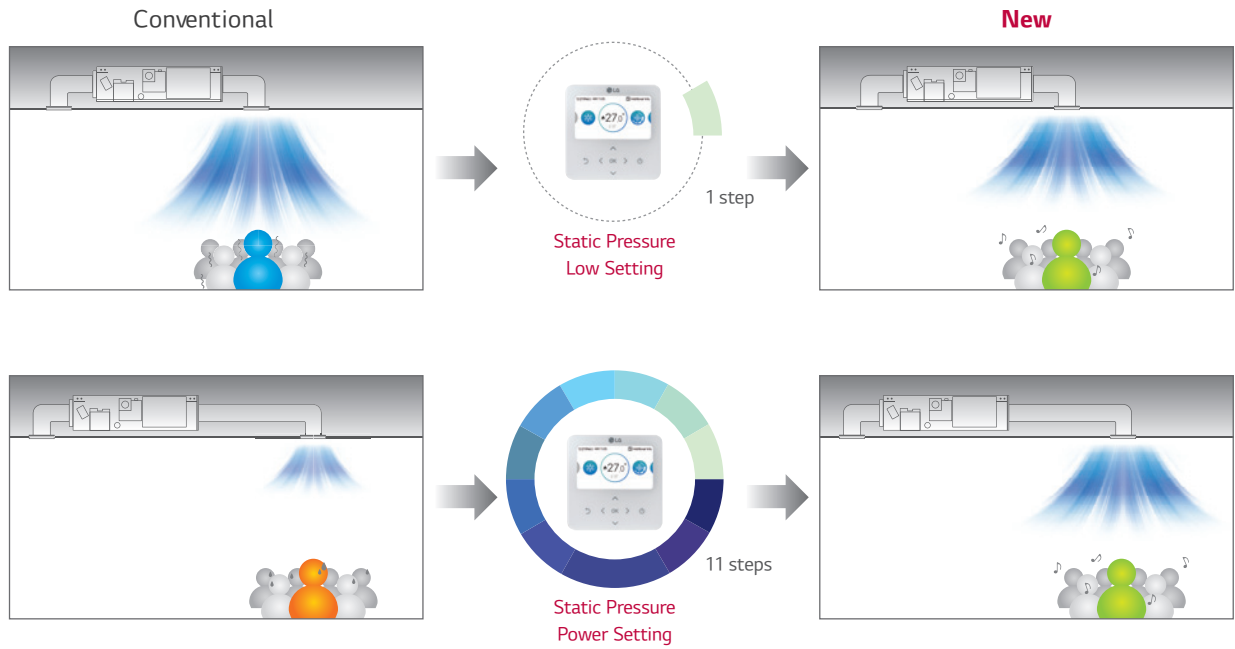

Energy Monitoring

Accumulated electric energy of the indoor unit can be identified with wired remote control, as well as with the central controller. This function is an advantage for energy management.

Install Scene

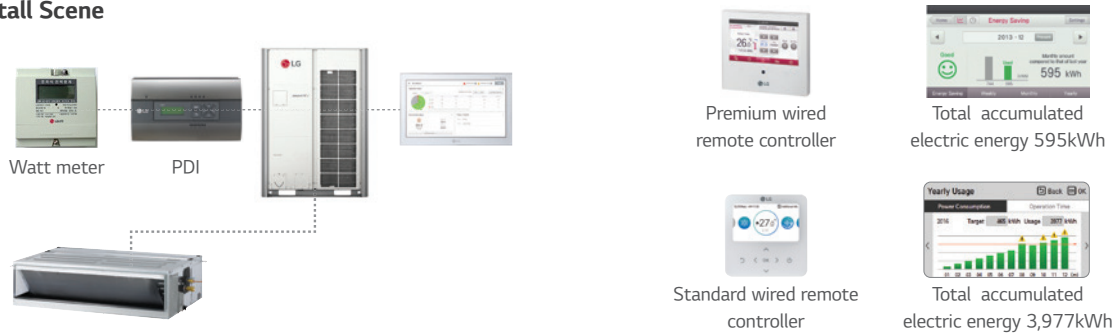

Apply for multistory building



※ Outdoor unit's accumulated electric energy / using rate of individual indoor unit + indoor unit's accumulated electric energy is displayed in wired remote controller, only when central controller, digital integrating electricity meter and PDI are installed and PDI, outdoor unit and indoor unit are connected with power wire. Only total accumulated electric energy is displayed in standard wired remote controller. In premium wired remote controller, that are displayed into week / month / year.

Safe Plus Insulation

Why LG Safe Plus Insulation?

Safe Plus Insulation is an antimicrobial treatment that is applied to LG MULTI V Indoor unit internal insulation components to resistance bacterial growth, and provides cleaner and fresher airflow to customer.

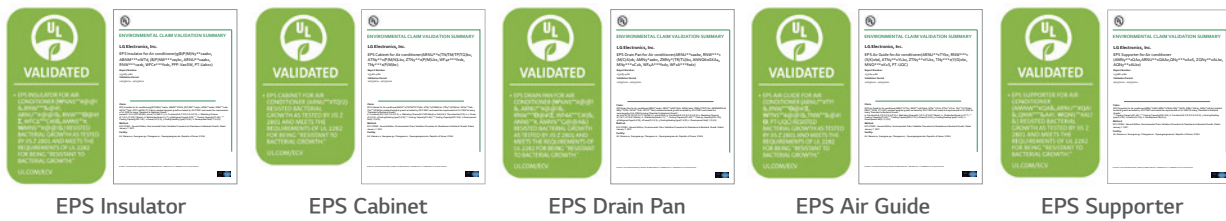
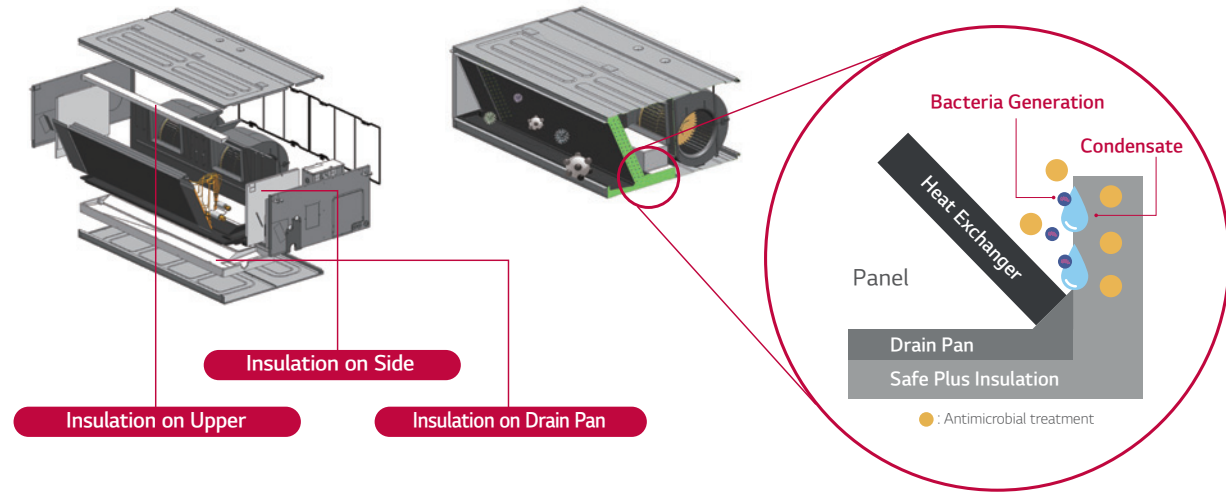

What's the hygiene inside of your air conditioner?



Example of EPS Pollution case.

Today's air conditioners, as well as fast cooling & energy saving are now basic, and all brand communicate each benefit of filtering bacteria, dust and mold and purifying contaminated air. However, What's the hygiene inside the air conditioner? If the inside of the air conditioner is contaminated, what can you do?

Antimicrobial treatment on ***EPS (Cabinet, Drain Pan, Air Guide, Insulator, Supporter)** for Air Conditioners is the first applied technology in the world, and only LG has.

Multiple Room Operation

Using a spiral duct (Embedded or flexible type) and stream chamber, it is possible to operate cooling / heating for several rooms simultaneously.

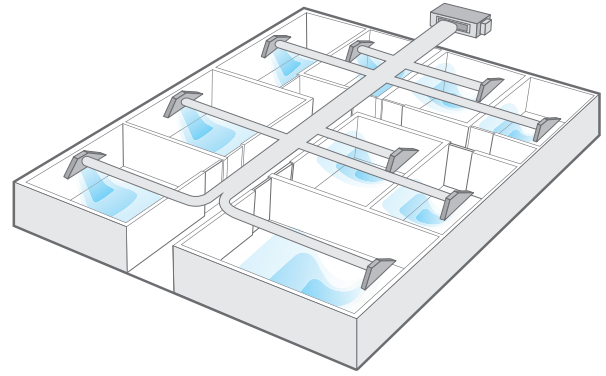

Filter Alert

The alarm is activated when the filter needs to be cleaned, and the time remaining for cleaning is displayed on the screen.

Remain Time Until Indoor Filter Cleaning + Alarm



Standard wired remote controller

Remain time until indoor filter cleaning 2,400hr.

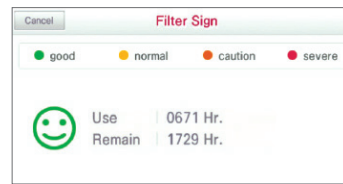

Premium wired remote controller

Remain time until indoor filter cleaning 1,729hr.

Flexible Installation (Low Static Duct Slim Only)

The alarm is activated when the filter needs to be cleaned, and the time remaining for cleaning is displayed on the screen.

Air intake at the rear or bottom

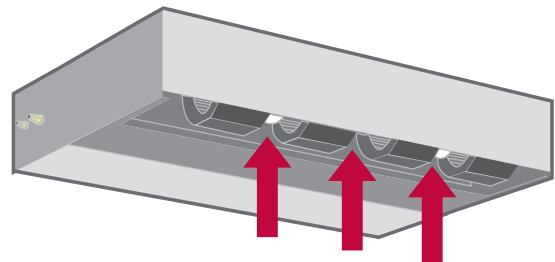
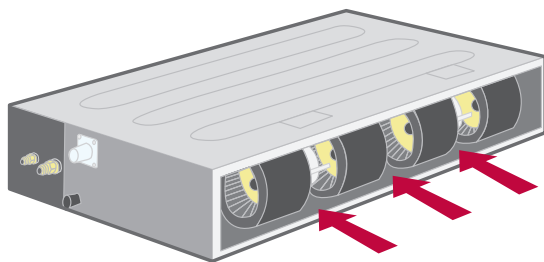
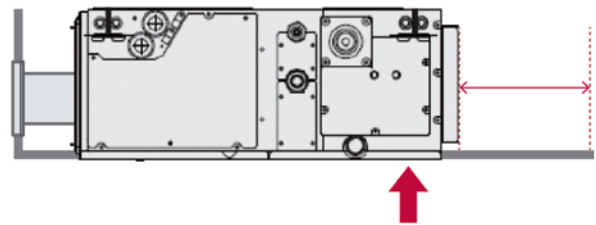
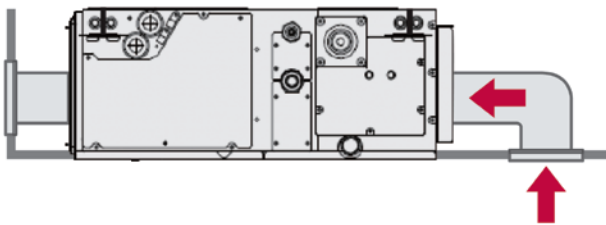

Minimized Height (For Mid Static Duct)

Mid Static Ducts provide ideal solution for installation in limited space.

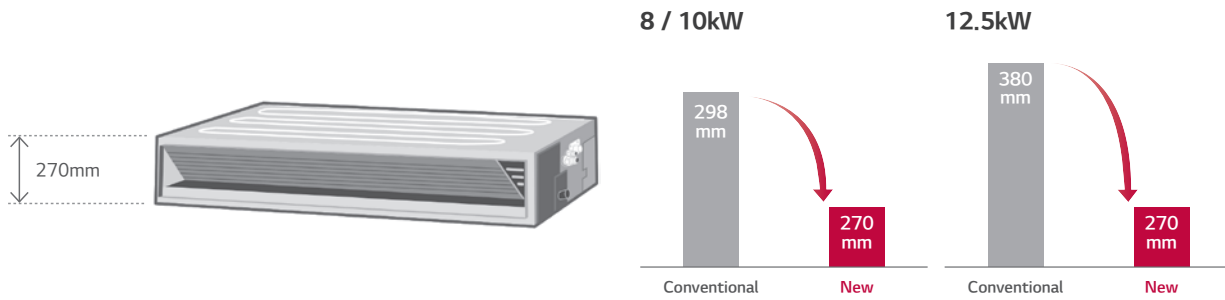

Two Thermistors Control

The indoor temperature can be checked using the thermi-stors in the remote controller as well as from the indoor unit. There may be a significant difference between ceiling and floor air temperature. Two thermistors can optimise indoor air temperature for a more comfortable environment.

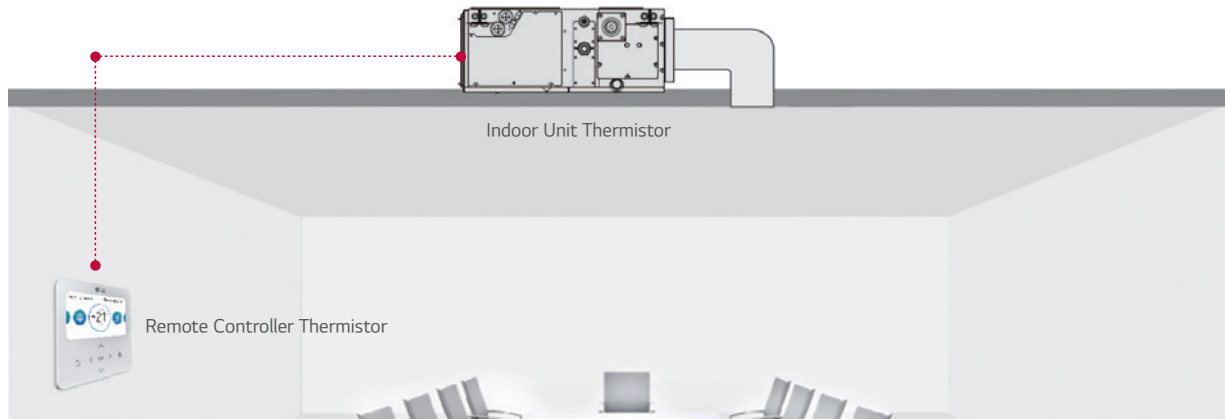

1 Point External Input (On / Off Control)

Indoor unit can be controlled by external devices without dry contact, so customer can save cost of installation.

Connection between an indoor unit and external devices directly

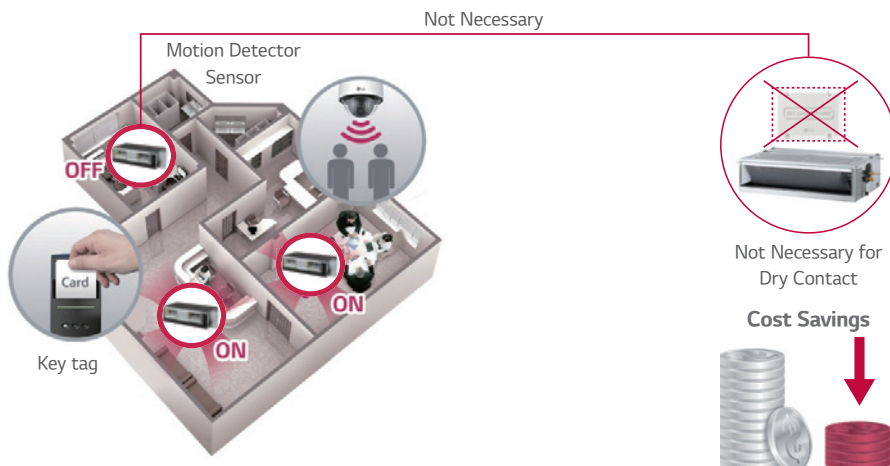

※ In case of needing more functions beside on / off control, a dry contact is required to be installed.

**ARNU07GM1A4 / ARNU09GM1A4
ARNU12GM1A4 / ARNU15GM1A4
ARNU18GM1A4 / ARNU24GM1A4**



MODEL		UNIT	ARNU07GM1A4	ARNU09GM1A4	ARNU12GM1A4	ARNU15GM1A4	ARNU18GM1A4	ARNU24GM1A4
Cooling Capacity		kW	2.2	2.8	3.6	4.5	5.6	7.1
Heating Capacity		kW	2.5	3.2	4.0	5.0	6.3	8.0
Power Input (H / M / L)	Nominal	W	39 / 30 / 25	40 / 32 / 26	46 / 38 / 31	67 / 53 / 46	85 / 63 / 55	91 / 74 / 58
	Body	mm	900 x 270 x 700	900 x 270 x 700	900 x 270 x 700	900 x 270 x 700	900 x 270 x 700	900 x 270 x 700
Dimensions (W x H x D)	Shipping	mm	1,100 x 338 x 773	1,100 x 338 x 773	1,100 x 338 x 773	1,100 x 338 x 773	1,100 x 338 x 773	1,100 x 338 x 773
	Type		Sirocco Fan	Sirocco Fan	Sirocco Fan	Sirocco Fan	Sirocco Fan	Sirocco Fan
Fan	Motor Output x Number	W x No.	136 x 1	136 x 1	136 x 1	136 x 1	136 x 1	136 x 1
	Air Flow Rate (H / M / L)	m ³ /min	9.0 / 7.5 / 6.0	9.5 / 7.5 / 6.0	11.0 / 9.0 / 7.0	16.0 / 12.0 / 9.0	17.0 / 14.5 / 12.0	19.0 / 16.0 / 14.0
	External Static Pressure (High Mode)	mmAq (Pa)	6 (59)	6 (59)	6 (59)	6 (59)	6 (59)	6 (59)
	Air Flow Rate (H / M / L) (Standard Mode)	m ³ /min	9.0 / 7.5 / 6.0	9.5 / 7.5 / 6.0	11.0 / 9.0 / 7.0	16.0 / 12.0 / 9.0	17.0 / 14.5 / 12.0	19.0 / 16.0 / 14.0
	External Static Pressure (Standard Mode)	mmAq (Pa)	2.5 (25)	2.5 (25)	2.5 (25)	2.5 (25)	2.5 (25)	2.5 (25)
	Motor Type		BLDC	BLDC	BLDC	BLDC	BLDC	BLDC
Air Filter			Pre Filter	Pre Filter	Pre Filter	Pre Filter	Pre Filter	Pre Filter
Pipe Connections	Liquid Side	mm (inch)	Ø6.35 (1/4)	Ø6.35 (1/4)	Ø6.35 (1/4)	Ø6.35 (1/4)	Ø6.35 (1/4)	Ø9.52 (3/8)
	Gas Side	mm (inch)	Ø12.7 (1/2)	Ø12.7 (1/2)	Ø12.7 (1/2)	Ø12.7 (1/2)	Ø12.7 (1/2)	Ø15.88 (5/8)
	Drain Pipe (Internal Dia.)	mm (inch)	25 (1)	25 (1)	Ø25 (1)	Ø25 (1)	Ø25 (1)	Ø25 (1)
Weight	Body	kg	25.0	25.0	25.0	25.0	25.0	25.9
Sound Pressure Levels (H / M / L)		dB(A)	26 / 24 / 23	27 / 25 / 23	27 / 25 / 23	30 / 27 / 23	31 / 28 / 25	32 / 29 / 26
Sound Power Levels (H / M / L)		dB(A)	55 / 54 / 51	55 / 54 / 52	56 / 54 / 52	59 / 57 / 55	59 / 57 / 55	59 / 58 / 56
Power Supply		Ø, V, Hz	1, 220-240, 50	1, 220-240, 50	1, 220-240, 50	1, 220-240, 50	1, 220-240, 50	1, 220-240, 50
Transmission Cable		mm ²	1.0 - 1.5 x 2C	1.0 - 1.5 x 2C	1.0 - 1.5 x 2C	1.0 - 1.5 x 2C	1.0 - 1.5 x 2C	1.0-1.5 x 2C

Note :

1. Performance tested under EN14511

2. Capacities are based on the following conditions

- Cooling : Indoor temp. 27°C (80.6°F) DB / 19°C (66.2°F) WB, Outdoor temp. 35°C (95°F) DB / 24°C (75.2°F) WB, Interconnecting piping length 7.5m, Level difference of zero

- Heating : Indoor temp. 20°C (68°F) DB / 15°C (59°F) WB, Outdoor temp. 7°C (44.6°F) DB / 6°C (42.8°F) WB, Interconnecting piping length 7.5m, Level difference of zero

3. Due to our policy of innovation, some specifications may be changed without notification

Accessories

CHASSIS	ARNU07GM1A4	ARNU09GM1A4	ARNU12GM1A4	ARNU15GM1A4	ARNU18GM1A4	ARNU24GM1A4
Drain Pump				○		
Cassette Cover				-		
Refrigerant Leakage Detector				PRLDNVSO (R410a)		
EEV Kit				PRGK024A0 (-5.6kW)		
Multi-tenant Power Module				PINPMB001		
Robot Cleaner				-		
Pre Filter (Washable)				○		
Ion Generator				-		
CO ₂ Sensor				-		
Ventilation Kit				-		
IR Receiver				PWLRVN000		
Zone Controller				ABZCA		
Dry Contact (with additional accessory)				PDRYCB000 (1 point contact), PDRYCB320, PDRYCB400 (2 points input), PDRYCB500 (Modbus)		
External Input (1 point)				○		
Wi-Fi				PWFMD200		

※ ○ : Applied, - : Not applied

Option : Refer to model name in table

ARNU28GM2A4 / ARNU36GM2A4
ARNU42GM2A4 / ARNU48GM3A4
ARNU54GM3A4

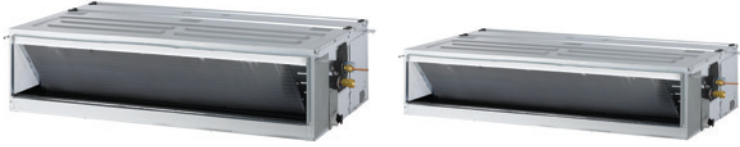

MODEL		UNIT	ARNU28GM2A4	ARNU36GM2A4	ARNU42GM2A4	ARNU48GM3A4	ARNU54GM3A4	
Cooling Capacity		kW	8.2	10.6	12.3	14.1	15.8	
Heating Capacity		kW	9.2	11.9	13.8	15.9	18.0	
Power Input (H / M / L)		Nominal W	123 / 81 / 57	184 / 123 / 81	231 / 162 / 111	172 / 105 / 65	260 / 215 / 172	
Dimensions (W x H x D)		Body	mm	1,250 x 270 x 700	1,250 x 270 x 700	1,250 x 270 x 700	1,250 x 360 x 700	1,250 x 360 x 700
		Shipping	mm	1,450 x 338 x 773	1,450 x 338 x 773	1,450 x 338 x 773	1,450 x 428 x 773	1,450 x 428 x 773
Fan		Type		Sirocco Fan	Sirocco Fan	Sirocco Fan	Sirocco Fan	Sirocco Fan
		Motor Output x Number	W x No.	350 x 1	350 x 1	350 x 1	400 x 1	400 x 1
		Air Flow Rate (H / M / L)	m ³ /min	28.0 / 24.0 / 21.0	32.0 / 28.0 / 24.0	38.0 / 33.0 / 28.0	40.0 / 34.0 / 28.0	50.0 / 45.0 / 40.0
		External Static Pressure (High Mode)	mmAq (Pa)	6 (59)	6 (59)	6 (59)	6 (59)	6 (59)
		Air Flow Rate (H / M / L) (Standard Mode)	m ³ /min	28.0 / 24.0 / 21.0	32.0 / 28.0 / 24.0	38.0 / 33.0 / 28.0	40.0 / 34.0 / 28.0	50.0 / 45.0 / 40.0
		External Static Pressure (Standard Mode)	mmAq (Pa)	5 (49)	5 (49)	5 (49)	5 (49)	5 (49)
		Motor Type		BLDC	BLDC	BLDC	BLDC	BLDC
Air Filter			Pre Filter	Pre Filter	Pre Filter	Pre Filter	Pre Filter	
Pipe Connections		Liquid Side	mm (inch)	Ø9.52 (3/8)	Ø9.52 (3/8)	Ø9.52 (3/8)	Ø9.52 (3/8)	Ø9.52 (3/8)
		Gas Side	mm (inch)	Ø15.88 (5/8)	Ø15.88 (5/8)	Ø15.88 (5/8)	Ø15.88 (5/8)	Ø19.05 (3/4)
		Drain Pipe (Internal Dia.)	mm (inch)	Ø25 (1)	Ø25 (1)	Ø25 (1)	Ø25 (1)	Ø25 (1)
Weight		Body	kg	36.0	36.0	37.2	42.2	42.2
Sound Pressure Levels (H / M / L)			dB(A)	38 / 36 / 35	40 / 38 / 36	42 / 41 / 39	41 / 38 / 37	42 / 41 / 40
Sound Power Levels (H / M / L)			dB(A)	59 / 57 / 55	60 / 59 / 57	62 / 61 / 60	63 / 60 / 59	65 / 64 / 62
Power Supply			Ø, V, Hz	1, 220-240, 50	1, 220-240, 50	1, 220-240, 50	1, 220-240, 50	1, 220-240, 50
Transmission Cable			mm ²	1.0 ~ 1.5 x 2C	1.0 ~ 1.5 x 2C	1.0 ~ 1.5 x 2C	1.0 ~ 1.5 x 2C	1.0 ~ 1.5 x 2C

Note :

1. Performance tested under EN14511

2. Capacities are based on the following conditions

- Cooling : Indoor temp. 27°C (80.6°F) DB / 19°C (66.2°F) WB, Outdoor temp. 35°C (95°F) DB / 24°C (75.2°F) WB, Interconnecting piping length 7.5m, Level difference of zero

- Heating : Indoor temp. 20°C (68°F) DB / 15°C (59°F) WB, Outdoor temp. 7°C (44.6°F) DB / 6°C (42.8°F) WB, Interconnecting piping length 7.5m, Level difference of zero

3. Due to our policy of innovation, some specifications may be changed without notification

Accessories

CHASSIS	ARNU28GM2A4	ARNU36GM2A4	ARNU42GM2A4	ARNU48GM3A4	ARNU54GM3A4
Drain Pump				○	
Cassette Cover				-	
Refrigerant Leakage Detector				PRLDNV50 (R410a)	
EEV Kit				-	
Multi-tenant Power Module				PINPMB001	
Robot Cleaner				-	
Pre Filter (Washable)				○	
Ion Generator				-	
CO ₂ Sensor				-	
Ventilation Kit				-	
IR Receiver				PWLRVN000	
Zone Controller				ABZCA	
Dry Contact (with additional accessory)				PDRYCB000 (1 point contact), PDRYCB320, PDRYCB400 (2 points input), PDRYCB500 (Modbus)	
External Input (1 point)				○	
Wi-Fi				PWFMD200	

※ ○ : Applied, - : Not applied

Option : Refer to model name in table

ARNU76GB8A4 / ARNU96GB8A4



MODEL		UNIT	ARNU76GB8A4	ARNU96GB8A4
Cooling Capacity		kW	22.4	28.0
Heating Capacity		kW	25.2	31.5
Power Input (H / M / L)	Nominal	W	765 / 500 / 500	800 / 750 / 750
	Body	mm	1,562 x 460 x 688	1,562 x 460 x 688
Dimensions (W x H x D)	Shipping	mm	1,806 x 537 x 825	1,806 x 537 x 825
	Type		Sirocco Fan	Sirocco Fan
Fan	Motor Output x Number	W x No.	375 x 2	375 x 2
	Air Flow Rate (H / M / L) (High Mode-Factory Set)	m ³ /min	60.0 / 50.0 / 50.0	72.0 / 64.0 / 64.0
	External Static Pressure (High Mode)	mmAq (Pa)	22 (216)	22 (216)
	Air Flow Rate (H / M / L) (Standard Mode)	m ³ /min	64.0 / 50.0 / 50.0	76.0 / 64.0 / 64.0
	External Static Pressure (Standard Mode)	mmAq (Pa)	15 (147)	15 (147)
	Motor Type		BLDC	BLDC
	Air Filter		Pre Filter	Pre Filter
Pipe Connections	Liquid Side	mm (inch)	Ø9.52 (3/8)	Ø9.52 (3/8)
	Gas Side	mm (inch)	Ø19.05 (3/4)	Ø22.2 (7/8)
	Drain Pipe (Internal Dia.)	mm (inch)	Ø25 (1)	Ø25 (1)
Weight	Body	kg	87.0	87.0
Sound Pressure Levels (H / M / L)		dB(A)	45 / 41 / 40	47 / 42 / 41
Sound Power Levels (H / M / L)		dB(A)	67 / 62 / 60	68 / 64 / 62
Power Supply		Ø, V, Hz	1, 220-240, 50	1, 220-240, 50
Transmission Cable		mm ²	1.0 - 1.5 x 2C	1.0 - 1.5 x 2C

Note:

- Performance tested under EN14511
- Capacities are based on the following conditions
 - Cooling : Indoor temp. 27°C (80.6°F) DB / 19°C (66.2°F) WB, Outdoor temp. 35°C (95°F) DB / 24°C (75.2°F) WB, Interconnecting piping length 7.5m, Level difference of zero
 - Heating : Indoor temp. 20°C (68°F) DB / 15°C (59°F) WB, Outdoor temp. 7°C (44.6°F) DB / 6°C (42.8°F) WB, Interconnecting piping length 7.5m, Level difference of zero
- Due to our policy of innovation, some specifications may be changed without notification

Accessories

CHASSIS	ARNU76GB8A4	ARNU96GB8A4
Drain Pump		○
Cassette Cover		-
Refrigerant Leakage Detector		PRLDNV50 (R410a)
EEV Kit		○
Multi-tenant Power Module		PINPMB001
Robot Cleaner		-
Pre Filter (Washable)		○
Ion Generator		-
CO ₂ Sensor		-
Ventilation Kit		-
IR Receiver		PWLRVN000
Zone Controller		ABZCA
Dry Contact (with additional accessory)		PDRYCB000 (1 point contact), PDRYCB320, PDRYCB400 (2 points input), PDRYCB500 (Modbus)
External Input (1 point)		○
Wi-Fi		PWFMD200

※ ○ : Applied, - : Not applied
Option : Refer to model name in table

**ARNU05GL4G4 / ARNU07GL4G4
ARNU09GL4G4 / ARNU12GL5G4**



MODEL		UNIT	ARNU05GL4G4	ARNU07GL4G4	ARNU09GL4G4	ARNU12GL5G4	
Cooling Capacity		kW	1.8	2.2	2.8	3.6	
Heating Capacity		kW	2.2	2.5	3.2	4	
Power Input (H / M / L)		Nominal W	15 / 13 / 11	28 / 24 / 21	28 / 24 / 21	43 / 38 / 35	
Dimensions (W x H x D)		Body	700 x 190 x 460	700 x 190 x 460	700 x 190 x 460	900 x 190 x 460	
		Shipping	925 x 255 x 561	925 x 255 x 561	925 x 255 x 561	1,125 x 255 x 561	
Fan		Type	Sirocco Fan	Sirocco Fan	Sirocco Fan	Sirocco Fan	
		Motor Output x Number	W x No.	19 x 1	19 x 1	19 x 1	19 x 1+5x 1
		Air Flow Rate (H / M / L) (High Mode-Factory Set)	m³/min	7.0 / 6.5 / 5.5	7.5 / 6.5 / 5.5	9.0 / 7.0 / 5.5	10.0 / 8.5 / 7.0
		External Static Pressure (High Mode)	mmAq (Pa)	1 (10)	1 (10)	1 (10)	1 (10)
		Air Flow Rate (H / M / L) (Standard Mode)	m³/min	7.0 / 6.5 / 5.5	7.5 / 6.5 / 5.5	9.0 / 7.0 / 5.5	10.0 / 8.5 / 7.0
		External Static Pressure (Standard Mode)	mmAq (Pa)	0 (0)	0 (0)	0 (0)	0 (0)
		Motor Type		BLDC	BLDC	BLDC	BLDC
		Air Filter			Pre Filter	Pre Filter	Pre Filter
Pipe Connections		Liquid Side	mm (inch)	6.35 (1/4)	6.35 (1/4)	6.35 (1/4)	
		Gas Side	mm (inch)	12.7 (1/2)	12.7 (1/2)	12.7 (1/2)	
		Drain Pipe (Internal Dia.)	mm (inch)	Ø25.4 (1)	Ø25.4 (1)	Ø25.4 (1)	Ø25.4 (1)
Weight		Body	kg	14.6	14.6	14.6	20
Sound Pressure Levels (H / M / L)			dB(A)	25 / 24 / 22	26 / 24 / 22	28 / 25 / 22	29 / 27 / 25
Sound Power Levels (H / M / L)			dB(A)	32.5 / 31.4 / 29.6	34 / 31.4 / 29.6	36.1 / 32.5 / 29.6	35.1 / 32.7 / 30.7
Power Supply			∅, V, Hz	1, 220-230-240, 50/60	1, 220-230-240, 50/60	1, 220-230-240, 50/60	1, 220-230-240, 50/60
Transmission Cable			mm²	1.0-1.5 x 2C	1.0-1.5 x 2C	1.0-1.5 x 2C	1.0-1.5 x 2C

Note :

1. Performance tested under EN14511

2. Capacities are based on the following conditions

- Cooling : Indoor temp. 27°C (80.6°F) DB / 19°C (66.2°F) WB, Outdoor temp. 35°C (95°F) DB / 24°C (75.2°F) WB, Interconnecting piping length 7.5m, Level difference of zero

- Heating : Indoor temp. 20°C (68°F) DB / 15°C (59°F) WB, Outdoor temp. 7°C (44.6°F) DB / 6°C (42.8°F) WB, Interconnecting piping length 7.5m, Level difference of zero

3. Due to our policy of innovation, some specifications may be changed without notification

Accessories

CHASSIS	ARNU05GL4G4	ARNU07GL4G4	ARNU09GL4G4	ARNU12GL5G4
Drain Pump			○	
Cassette Cover			-	
Refrigerant Leakage Detector			PRLDNVS0 (R410a)	
EEV Kit			PRGK024A0 (ARNU**GL4G4 Only)	
Multi-tenant Power Module			PINPMB001	
Robot Cleaner			-	
Pre Filter (Washable)			○	
Ion Generator			-	
CO ₂ Sensor			-	
Ventilation Kit			-	
IR Receiver			PWLRVN000	
Zone Controller			-	
Dry Contact (with additional accessory)			PDRYCB000 (1 point contact), PDRYCB320, PDRYCB400 (2 points input), PDRYCB500 (Modbus)	
External Input (1 point)			○	
Wi-Fi			PWFMD200	

※ ○ : Applied, - : Not applied

Option : Refer to model name in table

**ARNU15GL5G4 / ARNU18GL5G4
ARNU21GL6G4 / ARNU24GL6G4**



MODEL		UNIT	ARNU15GL5G4	ARNU18GL5G4	ARNU21GL6G4	ARNU24GL6G4
Cooling Capacity		kW	4.5	5.6	6.3	7.1
Heating Capacity		kW	5	6.3	7.1	8
Power Input (H / M / L)	Nominal	W	54 / 45 / 38	57 / 39 / 30	65 / 50 / 42	81 / 59 / 43
Dimensions (W x H x D)	Body	mm	900 x 190 x 460	900 x 190 x 460	1,100 x 190 x 460	1,100 x 190 x 460
	Shipping	mm	1,125 x 255 x 561	1,125 x 255 x 561	1,325 x 255 x 561	1,325 x 255 x 561
Fan	Type		Sirocco Fan	Sirocco Fan	Sirocco Fan	Sirocco Fan
	Motor Output x Number	W x No.	19 x 1+5x 1	19 x 1+5x 1	19 x 2	19 x 2
	Air Flow Rate (H / M / L) (High Mode-Factory Set)	m³/min	12.5 / 10.0 / 8.5	15.0 / 12.5 / 10.0	17.5 / 14.0 / 12.0	20.0 / 16.0 / 12.0
	External Static Pressure (High Mode)	mmAq (Pa)	1 (10)	1 (10)	1 (10)	1 (10)
	Air Flow Rate (H / M / L) (Standard Mode)	m³/min	12.5 / 10.0 / 8.5	15.0 / 12.5 / 10.0	17.5 / 14.0 / 12.0	20.0 / 16.0 / 12.0
	External Static Pressure (Standard Mode)	mmAq (Pa)	0 (0)	0 (0)	0 (0)	0 (0)
	Motor Type		BLDC	BLDC	BLDC	BLDC
Air Filter			Pre Filter	Pre Filter	Pre Filter	Pre Filter
Pipe Connections	Liquid Side	mm (inch)	6.35 (1/4)	6.35 (1/4)	9.52 (3/8)	9.52 (3/8)
	Gas Side	mm (inch)	12.7 (1/2)	12.7 (1/2)	15.88 (5/8)	15.88 (5/8)
	Drain Pipe (Internal Dia.)	mm (inch)	Ø25.4 (1)	Ø25.4 (1)	Ø25.4 (1)	Ø25.4 (1)
Weight	Body	kg	20	20	22	22
Sound Pressure Levels (H / M / L)		dB(A)	32 / 29 / 27	35 / 32 / 29	35 / 30 / 29	36 / 33 / 29
Sound Power Levels (H / M / L)		dB(A)	38.4 / 35.1 / 32.7	42.1 / 38.4 / 35.1	42.5 / 38.3 / 36.0	45.0 / 40.7 / 36.0
Power Supply		Ø, V, Hz	1, 220-230-240, 50/60	1, 220-230-240, 50/60	1, 220-230-240, 50/60	1, 220-230-240, 50/60
Transmission Cable		mm²	1.0-1.5 x 2C	1.0-1.5 x 2C	1.0-1.5 x 2C	1.0-1.5 x 2C

Note :

- Performance tested under EN14511
- Capacities are based on the following conditions
 - Cooling : Indoor temp. 27°C (80.6°F) DB / 19°C (66.2°F) WB, Outdoor temp. 35°C (95°F) DB / 24°C (75.2°F) WB, Interconnecting piping length 7.5m, Level difference of zero
 - Heating : Indoor temp. 20°C (68°F) DB / 15°C (59°F) WB, Outdoor temp. 7°C (44.6°F) DB / 6°C (42.8°F) WB, Interconnecting piping length 7.5m, Level difference of zero
- Due to our policy of innovation, some specifications may be changed without notification

Accessories

CHASSIS	ARNU15GL5G4	ARNU18GL5G4	ARNU21GL6G4	ARNU24GL6G4
Drain Pump			○	
Cassette Cover			-	
Refrigerant Leakage Detector			PRLDNVSO (R410a)	
EEV Kit			-	
Multi-tenant Power Module			PINPMB001	
Robot Cleaner			-	
Pre Filter (Washable)			○	
Ion Generator			-	
CO ₂ Sensor			-	
Ventilation Kit			-	
IR Receiver			PWLRVN000	
Zone Controller			-	
Dry Contact (with additional accessory)			PDRYCB000 (1 point contact), PDRYCB320, PDRYCB400 (2 points input), PDRYCB500 (Modbus)	
External Input (1 point)			○	
Wi-Fi			PWFMD200	

※ ○ : Applied, - : Not applied
Option : Refer to model name in table

**ARNU07GM2A4 / ARNU09GM2A4
ARNU12GM2A4 / ARNU15GM2A4
ARNU18GM3A4**



MODEL		UNIT	ARNU07GM2A4	ARNU09GM2A4	ARNU12GM2A4	ARNU15GM2A4	ARNU18GM3A4
Cooling Capacity		kW	2.2	2.8	3.6	4.5	5.6
Heating Capacity		kW	2.5	3.2	4.0	5.0	6.3
Power Input (H / M / L)		W	32 / 29 / 27	32 / 29 / 27	33 / 30 / 28	33 / 30 / 28	97 / 70 / 51
Dimensions (W x H x D)	Body	mm	1,250 x 270 x 700	1,250 x 270 x 700	1,250 x 270 x 700	1,250 x 270 x 700	1,250 x 360 x 700
	Type		Sirocco Fan	Sirocco Fan	Sirocco Fan	Sirocco Fan	Sirocco Fan
	Motor Output x Number	W x No.	350 x 1	350 x 1	350 x 1	350 x 1	500 x 1
Fan	Air Flow Rate (H / M / L) (High static Mode - factory set)	m ³ /min	13.3 / 9.4 / 6.8	13.3 / 9.4 / 6.8	14.8 / 10.2 / 7.4	14.8 / 10.2 / 7.4	32.7 / 26.7 / 23.0
	External Static Pressure	mmAq (Pa)	6 (59)	6 (59)	6 (59)	6 (59)	6 (59)
	Air Flow Rate (H / M / L) (Standard Mode)	m ³ /min	13.3 / 9.4 / 6.8	13.3 / 9.4 / 6.8	14.8 / 10.2 / 7.4	14.8 / 10.2 / 7.4	32.7 / 26.7 / 23.0
	External Static Pressure	mmAq (Pa)	5 (49)	5 (49)	5 (49)	5 (49)	5 (49)
	Motor type		BLDC	BLDC	BLDC	BLDC	BLDC
	Air Filter		-	-	-	-	-
Pipe Connections	Liquid Side	mm (inch)	Ø9.52 (3/8)	Ø9.52 (3/8)	Ø9.52 (3/8)	Ø9.52 (3/8)	Ø9.52 (3/8)
	Gas Side	mm (inch)	Ø15.88 (5/8)	Ø15.88 (5/8)	Ø15.88 (5/8)	Ø15.88 (5/8)	Ø15.88 (5/8)
	Drain Pipe (Internal Dia.)	mm (inch)	25 (1)	25 (1)	25 (1)	25 (1)	25 (1)
Net Weight	kg	36	36	36	36	44	
Sound Pressure Levels (H / M / L)		dB(A)	33 / 33 / 32	33 / 33 / 32	34 / 33 / 32	34 / 33 / 32	38 / 36 / 34
Sound Power Levels (H / M / L)		dB(A)	52 / 52 / 52	52 / 52 / 52	53 / 52 / 52	53 / 52 / 52	52 / 51 / 50
Power Supply		Ø, V, Hz	1, 220-240, 50	1, 220-240, 50	1, 220-240, 50	1, 220-240, 50	1, 220-240, 50
Transmission Cable		mm ²	1.0 ~ 1.5 x 2C	1.0 ~ 1.5 x 2C	1.0 ~ 1.5 x 2C	1.0 ~ 1.5 x 2C	1.0 ~ 1.5 x 2C

Note :

1. Due to our policy of innovation some specifications may be changed without notification.
2. Wiring cable size must comply with the applicable local and national code. And "Electric characteristics" chapter should be considered for electrical work and design. Especially the power cable and circuit breaker should be selected in accordance with that.
3. Sound pressure level is measured on the rated condition in the anechoic rooms by ISO 3745 standard. Sound power level is measured on the rated condition in the reverberation rooms by ISO 3741 standard. Therefore, these values can be increased owing to ambient conditions during operation.
4. Capacities are net capacities and based on the following conditions. Refer to the Outdoor Unit Specifications for calculating the real capacity.
- Cooling : Indoor Ambient Temp. 27°CDB / 19°CWB, Outdoor Ambient Temp. 35°CDB / 24°CWB
- Heating : Indoor Ambient Temp. 20°CDB / 15°CWB, Outdoor Ambient Temp. 7°CDB / 6°CWB
- Interconnected Pipe is standard length and difference of Elevation (Outdoor - Indoor Unit) is Zero.
5. Sound levels are measured at 50Pa External Static Pressure condition.
6. * : Air flow rate could be different in accordance with External Static Pressure and setting value.

Accessories

CHASSIS	ARNU07GM2A4	ARNU09GM2A4	ARNU12GM2A4	ARNU15GM2A4	ARNU18GM3A4
Drain Pump			○		
Cassette Cover			-		
Refrigerant Leakage Detector			PRLDNV50 (R410a)		
EEV Kit			-		
Multi-tenant Power Module			PINPMB001		
Robot Cleaner			-		
Pre Filter (Washable)			○		
Ion Generator			-		
CO ₂ Sensor			-		
Ventilation Kit			-		
IR Receiver			PWLRV/N000		
Zone Controller			ABZCA		
Dry Contact (with additional accessory)			PDRYCB000 (1 point contact), PDRYCB320, PDRYCB400 (2 points input), PDRYCB500 (Modbus)		
External Input (1 point)			○		
Wi-Fi			PWFMD200		

※ ○ : Applied, - : Not applied
Option : Refer to model name in table

**ARNU24GM3A4 / ARNU28GM3A4
ARNU36GB8A4 / ARNU42GB8A4
ARNU48GB8A4**



MODEL		UNIT	ARNU24GM3A4	ARNU28GM3A4	ARNU36GB8A4	ARNU42GB8A4	ARNU48GB8A4
Cooling Capacity		kW	7.1	8.2	10.6	12.3	14.1
Heating Capacity		kW	8.0	9.2	11.9	13.8	15.9
Power Input (H / M / L)		W	109 / 83 / 60	109 / 83 / 60	420 / 403 / 478	528 / 497 / 465	538 / 505 / 482
Dimensions (W x H x D)	Body	mm	1,250 x 360 x 700	1,250 x 360 x 700	1,562 x 460 x 688	1,562 x 460 x 688	1,562 x 460 x 688
	Type		Sirocco Fan	Sirocco Fan	Sirocco Fan	Sirocco Fan	Sirocco Fan
Fan	Motor Output x Number	W x No.	500 x 1	500 x 1	375 x 2	375 x 2	375 x 2
	Air Flow Rate (H / M / L) (High static Mode - factory set)	m ³ /min	35.5 / 30.6 / 26.2	35.5 / 30.6 / 26.2	49.0 / 37.3 / 30.2	54.2 / 41.3 / 31.8	57.2 / 43.0 / 34.0
	External Static Pressure	mmAq (Pa)	6 (59)	6 (59)	18 (176)	18 (176)	18 (176)
	Air Flow Rate (H / M / L) (Standard Mode)	m ³ /min	35.5 / 30.6 / 26.2	35.5 / 30.6 / 26.2	53.7 / 49.5 / 43.9	55.6 / 50.6 / 45.0	58.0 / 52.3 / 47.3
	External Static Pressure	mmAq (Pa)	5 (49)	5 (49)	9 (88)	9 (88)	9 (88)
	Motor type		BLDC	BLDC	BLDC	BLDC	BLDC
Air Filter			-	-	-	-	-
Pipe Connections	Liquid Side	mm (inch)	Ø9.52 (3/8)	Ø9.52 (3/8)	Ø9.52 (3/8)	Ø9.52 (3/8)	Ø9.52 (3/8)
	Gas Side	mm (inch)	Ø15.88 (5/8)	Ø15.88 (5/8)	Ø19.05 (3/4)	Ø19.05 (3/4)	Ø19.05 (3/4)
	Drain Pipe (Internal Dia.)	mm (inch)	25 (1)	25 (1)	25 (1)	25 (1)	25 (1)
Net Weight		kg	42.2	42.2	87	87	87
Sound Pressure Levels (H / M / L)		dB(A)	39 / 37 / 35	39 / 37 / 35	46 / 45 / 42	47 / 46 / 43	47 / 46 / 44
Sound Power Levels (H / M / L)		dB(A)	53 / 52 / 51	53 / 52 / 51	65 / 64 / 62	66 / 65 / 63	66 / 65 / 64
Power Supply		Ø, V, Hz	1, 220-240, 50	1, 220-240, 50	1, 220-240, 50	1, 220-240, 50	1, 220-240, 50
Transmission Cable		mm ²	1.0 ~ 1.5 x 2C	1.0 ~ 1.5 x 2C	1.0 ~ 1.5 x 2C	1.0 ~ 1.5 x 2C	1.0 ~ 1.5 x 2C

Note :

1. Due to our policy of innovation some specifications may be changed without notification.
2. Wiring cable size must comply with the applicable local and national code. And "Electric characteristics" chapter should be considered for electrical work and design. Especially the power cable and circuit breaker should be selected in accordance with that.
3. Sound pressure level is measured on the rated condition in the anechoic rooms by ISO 3745 standard. Sound power level is measured on the rated condition in the reverberation rooms by ISO 3741 standard. Therefore, these values can be increased owing to ambient conditions during operation.
4. Capacities are net capacities and based on the following conditions. Refer to the Outdoor Unit Specifications for calculating the real capacity.
 - Cooling : Indoor Ambient Temp. 27°CDB / 19°CWB, Outdoor Ambient Temp. 35°CDB / 24°CWB
 - Heating : Indoor Ambient Temp. 20°CDB / 15°CWB, Outdoor Ambient Temp. 7°CDB / 6°CWB
 - Interconnected Pipe is standard length and difference of Elevation (Outdoor - Indoor Unit) is Zero.
5. Sound levels are measured at 50Pa External Static Pressure condition.
6. * : Air flow rate could be different in accordance with External Static Pressure and setting value.

Accessories

CHASSIS	ARNU24GM3A4	ARNU28GM3A4	ARNU36GB8A4	ARNU42GB8A4	ARNU48GB8A4
Drain Pump			○		
Cassette Cover			-		
Refrigerant Leakage Detector			PRLDNVSO (R410a)		
EEV Kit			-		
Multi-tenant Power Module			PINPMB001		
Robot Cleaner			-		
Pre Filter (Washable)			○		
Ion Generator			-		
CO ₂ Sensor			-		
Ventilation Kit			-		
IR Receiver			PWLRVN000		
Zone Controller			ABZCA		
Dry Contact (with additional accessory)			PDRYCB000 (1 point contact), PDRYCB320, PDRYCB400 (2 points input), PDRYCB500 (Modbus)		
External Input (1 point)			○		
Wi-Fi			PWFMD200		

※ ○ : Applied, - : Not applied
Option : Refer to model name in table

Fresh Outdoor Air Supply

The LG Fresh Air Intake Unit (FAU) is the alternative solution for ventilation, which supplies the fresh outdoor air indoors as well as and simultaneously cools and heats the air inside. It means the indoor space can have positive air pressure consistently, which can block cold, hot or contaminated air from outside. This allows the indoor space to have consistent positive air pressure blocking cold air.

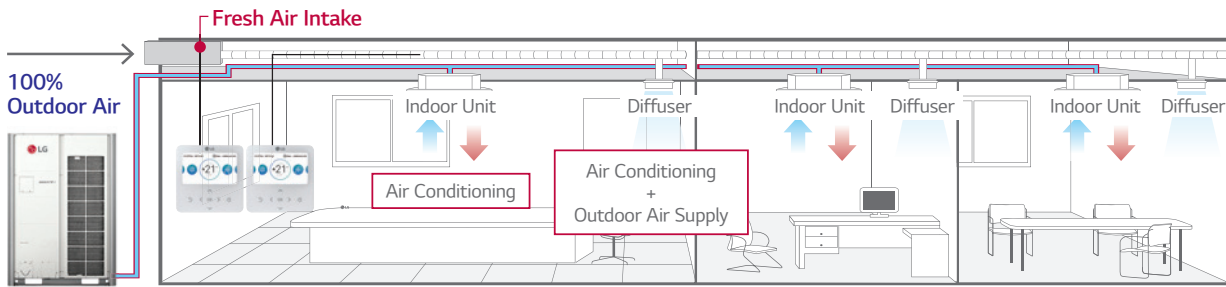

MULTI V i Outdoor unit

Economic Operation

Natural outdoor air is utilized as seasons change for cost efficiency.

Spring Season

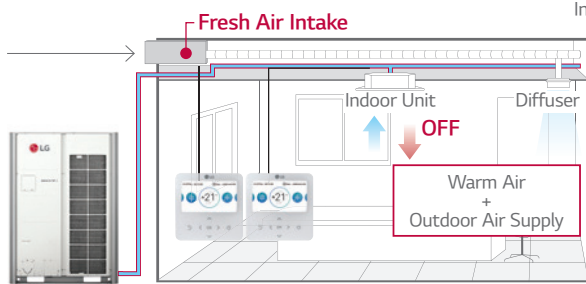

MULTI V i Outdoor unit

Autumn Season

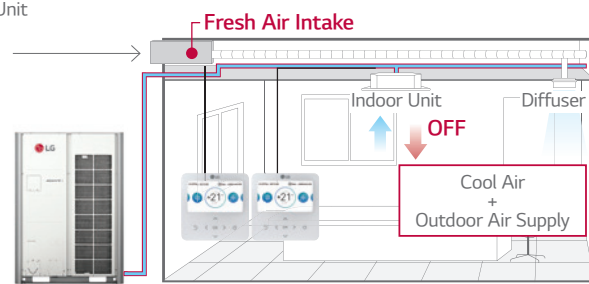

MULTI V i Outdoor unit

Installation Scene

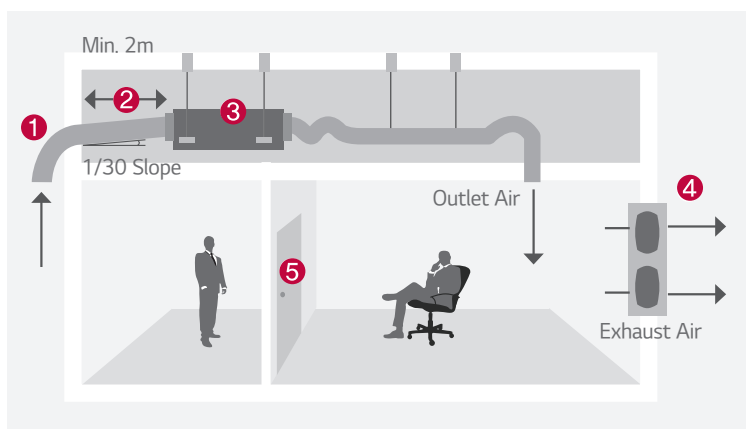

- ① Inlet Hood
- ② Intake Air Duct
- ③ Fresh Air Intake Unit
- ④ Exhaust Fan
- ⑤ Door

ARNU76GB8Z4 / ARNU96GB8Z4



MODEL	UNIT	ARNU76GB8Z4	ARNU96GB8Z4
Cooling Capacity	kW	22.4	28.0
Heating Capacity	kW	21.4	26.7
Power Input (H / M / L)	Nominal W	230 / 200 / 200	360 / 230 / 230
Dimensions (W x H x D)	Body	mm	1,562 x 460 x 688
	Shipping	mm	1,806 x 537 x 825
Fan	Type		Sirocco Fan
	Motor Output x Number	W x No.	375 x 1
	Air Flow Rate (H / M / L) (High Mode-Factory Set)	m ³ /min	23.7 / 13.2 / 13.2
	External Static Pressure	mmAq (Pa)	22 (216)
	Motor Type		BLDC
Air Filter		Long Life Filter	Long Life Filter
Pipe Connections	Liquid Side	mm (inch)	Ø9.52 (3/8)
	Gas Side	mm (inch)	Ø19.05 (3/4)
	Drain Pipe (Internal Dia.)	mm (inch)	Ø25 (1)
Weight	Body	kg	73.0
Sound Pressure Levels (H / M / L)		dB(A)	45 / 43 / 43
Sound Power Levels (H / M / L)		dB(A)	70 / 67 / 67
Power Supply		Ø, V, Hz	1, 220-240, 50
Transmission Cable		mm ²	1.0 - 1.5 x 2C

Note : 1. Performance tested under EN14511
 2. Capacities are based on the following conditions
 - Cooling : Indoor temp. 27°C (80.6°F) DB / 19°C (66.2°F) WB, Outdoor temp. 35°C (95°F) DB / 24°C (75.2°F) WB, Interconnecting piping length 7.5m, Level difference of zero
 - Heating : Indoor temp. 20°C (68°F) DB / 15°C (59°F) WB, Outdoor temp. 7°C (44.6°F) DB / 6°C (42.8°F) WB, Interconnecting piping length 7.5m, Level difference of zero
 3. Due to our policy of innovation, some specifications may be changed without notification

NO	CONNECTION CONDITION	COMBINATION
1	Fresh air intake units only are connected with outdoor units	1) The total capacity of fresh air intake unit should be 50 - 100% of outdoor unit. 2) The max quantity of fresh air intake is 4 units.
2	Mixture connection with general indoor unit and fresh intake units	1) The total capacity of indoor units (Standard Indoor Unit + Fresh Air Intake Unit) should be 50 - 100% of outdoor unit. 2) The total capacity of fresh air intake unit should be less than 30% of the total capacity of indoor units.

Accessories

CHASSIS	ARNU76GB8Z4	ARNU96GB8Z4
Drain Pump		○
Cassette Cover		-
Refrigerant Leakage Detector		PRLDNV50 (R410a)
EEV Kit		-
Multi-tenant Power Module		PINPMB001
Robot Cleaner		-
Pre Filter (Washable)		○
Ion Generator		-
CO ₂ Sensor		-
Ventilation Kit		-
IR Receiver		PWLRVN000
Zone Controller		-
Dry Contact (with additional accessory)		PDRYCB000 (1 point contact), PDRYCB320, PDRYCB400 (2 points input), PDRYCB500 (Modbus)
External Input (1 point)		○
Wi-Fi		PWFMD200

※ ○ : Applied, - : Not applied
 Option : Refer to model name in table

CEILING & FLOOR CONVERTIBLE, CEILING SUSPENDED



Features & Benefits

- Modern design with V-shape and black vane
- Powerful air speed and volume can reach up to 15m

Key Applications

- Retail
- Restaurant
- Shop

	CEILINGS	CEILING & FLOOR CONVERTIBLE	CEILING SUSPENDED
Smart	Wi-Fi	○	○
Fast Cooling & Heating	Jet Cool	○	○
Comfort	Sleep mode	○	○
	Timer (On / Off)	○	○
	Timer (Weekly)	○	○
	Two thermistor control	○	○
	Group control	○	○

※ ○: Applied, - : Not applied

Wi-Fi Control

Access your air conditioner anytime and from anywhere.

ThinQ

Search "ThinQ" on Google market or the App Store to download the app.

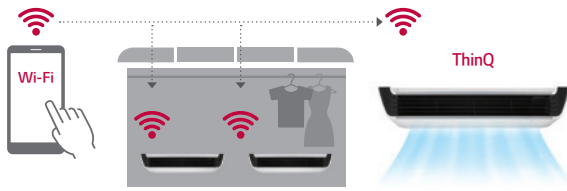

Easy Registration and Log-in

Follow the easy set-up steps that will activate ThinQ's impressive feature.

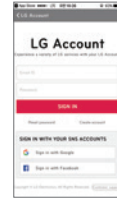

※ For our policy of continuous ThinQ App improvement, specification, design and features are subject to change without prior notice.

Flexible

The ceiling and floor models can be installed either on the ceiling or on the floor.

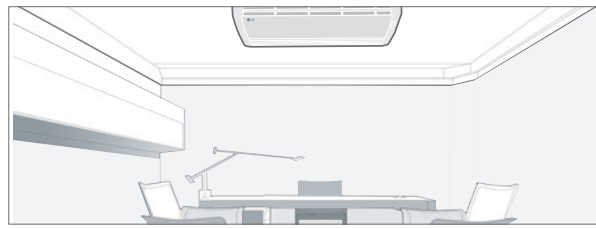
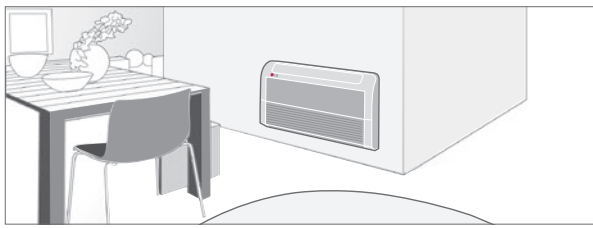

Filter Change Alarm

The filter change alarm informs you when the unit has been operating for 2,400 hours.



One Touch Filter

Filter Change Alarm

Air Flow Direction Control

Vertical air flow direction can be adjusted using remote controller, and horizontal air flow direction can be adjusted manually.

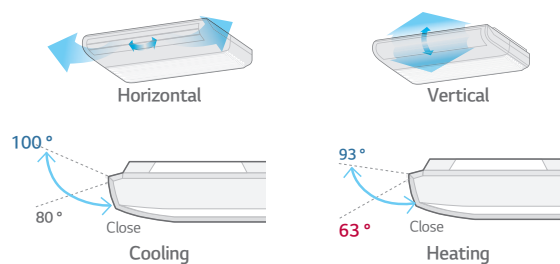

Differentiated Design

Modern elegance design with V-shape and black vane is appropriate for any commercial space. It received iF Design Award.



Powerful Cooling & Heating

High ceiling mode provides powerful cooling and heating up to 4.2m in height from floor, 15m away from ceiling.



One Touch & 2 Piece Filter

Easy in / out filter structure as well as a simplified two-piece filter, which slides out for easy cleaning and maintenance.

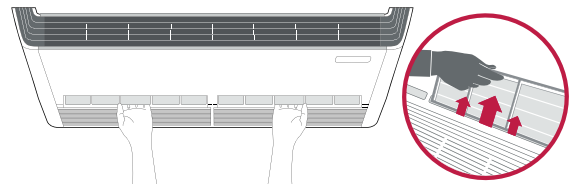

One Touch Filter

Two Thermistors Control

Users can purchase a wired remote controller that includes a second thermistor, allowing for temperature checks from multiple locations.

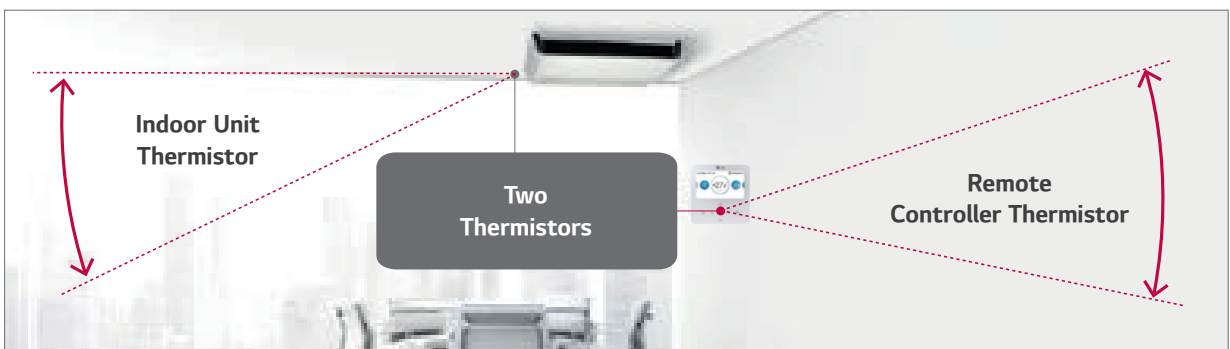

ARNU09GVEA4 / ARNU12GVEA4



MODEL		UNIT	ARNU09GVEA4	ARNU12GVEA4
Cooling Capacity		kW	2.8	3.6
Heating Capacity		kW	3.2	4.0
Power Input (H / M / L) Nominal		W	19 / 15 / 11	28 / 19 / 15
Exterior Color			Morning Fog	Morning Fog
RAL Code			RAL 9001	RAL 9001
Dimensions (W x H x D)	Body	mm	900 x 490 x 200	900 x 490 x 200
	Shipping	mm	975 x 562 x 279	975 x 562 x 279
Fan			Cross Flow Fan	Cross Flow Fan
Motor Output x Number		W x No.	27 x 1	27 x 1
Air Flow Rate (H / M / L)		m ³ /min	7.6 / 6.9 / 6.2	9.2 / 7.6 / 6.9
		cfm	268 / 244 / 219	325 / 268 / 244
Motor Type			BLDC	BLDC
Air Filter			Pre Filter	Pre Filter
Pipe Connections	Liquid Side	mm (inch)	Ø6.35 (1/4)	Ø6.35 (1/4)
	Gas Side	mm (inch)	Ø12.7 (1/2)	Ø12.7 (1/2)
	Drain Pipe (Internal Dia.)	mm (inch)	Ø16 (5/8)	Ø16 (5/8)
Weight		kg	13.3	13.3
Sound Pressure Levels (H / M / L)		dB(A)	36 / 32 / 28	38 / 36 / 30
Sound Power Levels (H / M / L)		dB(A)	55 / 51 / 45	56 / 55 / 49
Power Supply		Ø, V, Hz	1, 220-240, 50	1, 220-240, 50
Transmission Cable		mm ² x cores	1.0 ~ 1.5 x 2C	1.0 ~ 1.5 x 2C

Note : 1. Performance tested under EN14511
 2. Capacities are based on the following conditions
 - Cooling : Indoor temp. 27°C (80.6°F) DB / 19°C (66.2°F) WB, Outdoor temp. 35°C (95°F) DB / 24°C (75.2°F) WB, Interconnecting piping length 7.5m, Level difference of zero
 - Heating : Indoor temp. 20°C (68°F) DB / 15°C (59°F) WB, Outdoor temp. 7°C (44.6°F) DB / 6°C (42.8°F) WB, Interconnecting piping length 7.5m, Level difference of zero
 3. Due to our policy of innovation, some specifications may be changed without notification

Accessories

CHASSIS	ARNU09GVEA4	ARNU12GVEA4
Drain Pump		-
Refrigerant Leakage Detector		PRLDNV50 (R410a)
EEV Kit		PRGK024A0
Multi-tenant Power Module		PINPMB001
Plasma Kit		-
Robot Cleaner		-
Pre Filter (Washable)		○
Ion Generator		-
CO ₂ Sensor		-
Ventilation Kit		-
IR Receiver		-
Zone Controller		-
Dry Contact (with additional accessory)		PDRYCB000 (1 point contact), PDRYCB320, PDRYCB400 (2 points input), PDRYCB500 (Modbus)
External Input (1 point)		○
Wi-Fi		PWFMD200 ¹⁾

※ ○ : Applied, - : Not Applied
 Option: Refer to model name in table

ARNU18GV1A4 / ARNU24GV1A4
ARNU36GV2A4 / ARNU48GV2A4



MODEL		UNIT	ARNU18GV1A4	ARNU24GV1A4	ARNU36GV2A4	ARNU48GV2A4
Cooling Capacity		kW	5.6	7.1	10.6	14.1
Heating Capacity		kW	6.3	8.0	11.9	15.9
Power Input (H / M / L)		Nominal W	23 / 20 / 17	25 / 21 / 17	84 / 77 / 66	91 / 79 / 66
Exterior Color			Morning Fog	Morning Fog	Morning Fog	Morning Fog
RAL Code			RAL 9001	RAL 9001	RAL 9001	RAL 9001
Dimensions (W x H x D)	Body	mm	1,200 x 235 x 690	1,200 x 235 x 690	1,600 x 235 x 690	1,600 x 235 x 690
	Shipping	mm	1,315 x 320 x 772	1,315 x 320 x 772	1,715 x 320 x 772	1,715 x 320 x 772
Fan		Type	Cross Flow Fan	Cross Flow Fan	Cross Flow Fan	Cross Flow Fan
		Motor Output x Number	W x No.	85.9 x 1	85.9 x 1	125 x 1
		Air Flow Rate (H / M / L)	m ³ /min	13.5 / 12.5 / 12.0	14.0 / 13.0 / 12.0	27.0 / 24.0 / 20.0
		Motor Type	BLDC	BLDC	BLDC	BLDC
Air Filter			Pre Filter	Pre Filter	Pre Filter	Pre Filter
Pipe Connections	Liquid Side	mm (inch)	Ø6.35 (1/4)	Ø9.52 (3/8)	Ø9.52 (3/8)	Ø9.52 (3/8)
	Gas Side	mm (inch)	Ø12.7 (1/2)	Ø15.88 (5/8)	Ø15.88 (5/8)	Ø15.88 (5/8)
	Drain Pipe (Internal Dia.)	mm (inch)	Ø16 (5/8)	Ø16 (5/8)	Ø16 (5/8)	Ø16 (5/8)
Weight	Body	kg	29.0	29.0	37.0	37.0
Sound Pressure Levels (H / M / L)		dB(A)	36 / 34 / 33	37 / 35 / 33	45 / 44 / 40.5	47 / 44 / 40.5
Sound Power Levels (H / M / L)		dB(A)	61 / 59 / 56	62 / 59 / 56	68 / 66 / 64	68 / 67 / 66
Power Supply		Ø, V, Hz	1, 220-240, 50	1, 220-240, 50	1, 220-240, 50	1, 220-240, 50
Transmission Cable		mm ² x cores	1.0 ~ 1.5 × 2C	1.0 ~ 1.5 × 2C	1.0 ~ 1.5 × 2C	1.0 ~ 1.5 × 2C

Note : 1. Performance tested under EN14511

2. Capacities are based on the following conditions

- Cooling : Indoor temp. 27°C (80.6°F) DB / 19°C (66.2°F) WB, Outdoor temp. 35°C (95°F) DB / 24°C (75.2°F) WB, Interconnecting piping length 7.5m, Level difference of zero

- Heating : Indoor temp. 20°C (68°F) DB / 15°C (59°F) WB, Outdoor temp. 7°C (44.6°F) DB / 6°C (42.8°F) WB, Interconnecting piping length 7.5m, Level difference of zero

3. Due to our policy of innovation, some specifications may be changed without notification

Accessories

CHASSIS	ARNU18GV1A4	ARNU24GV1A4	ARNU36GV2A4	ARNU48GV2A4
Drain Pump				-
Cassette Cover				-
Refrigerant Leakage Detector		PRLDNV50 (R410a)		
EEV Kit				-
Multi-tenant Power Module		PINPMB001		
Robot Cleaner				-
Pre Filter (Washable)			○	
Ion Generator				-
CO ₂ Sensor				-
Ventilation Kit				-
IR Receiver				-
Zone Controller				-
Dry Contact (with additional accessory)		PDRYCB000 (1 point contact), PDRYCB320, PDRYCB400 (2 points input), PDRYCB500 (Modbus)		
External Input (1 point)			○	
Wi-Fi		PWFMD200		

※ ○ : Applied, - : Not Applied

Option: Refer to model name in table

CONSOLE & FLOOR STANDING



Features & Benefits

- 6 way flexible piping
- Cold draft window protection
- Condensation protection

Key Applications

- Residential building
- Historical building
- Hotel

	FLOOR STANDING	CONSOLE	FLOOR STANDING
Smart	Wi-Fi	○	○
Energy Efficiency	Jet Cool	-	○
Health	Ionizer	○	-
Fast Cooling & Heating	Jet Cool	○	-
Comfort	Sleep Mode	○	○
	Timer (On / Off)	○	○
	Timer (Weekly)	○	○
	Two Thermistor Control	○	○
	Group Control	○	○

※ ○: Applied, - : Not applied

Wi-Fi Control

Access your air conditioner anytime and from anywhere.

ThinQ

Search "ThinQ" on Google market or the App Store to download the app.

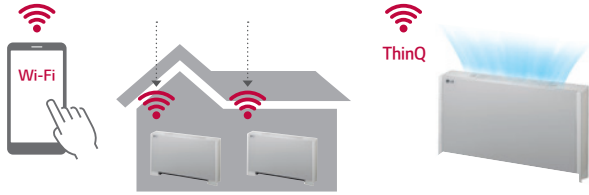

※ For our policy of continuous ThinQ App improvement, specification, design and features are subject to change without prior notice.

Air Flow Direction Change

During the cooling operation, the vane adjusts upwards to direct the air flow towards the ceiling. When heating, the vane directs the warm air downwards to balance the room temperature especially for floor.

Cooling

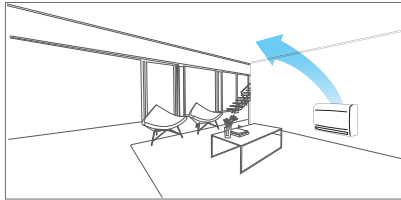

Heating (Normal)

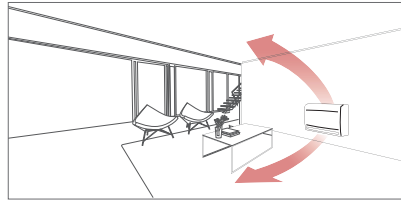

Heating (Option)

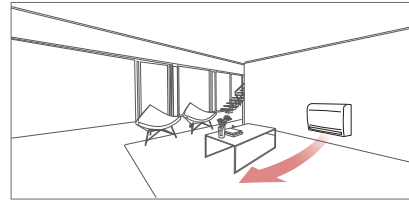

Cold Draft Protection

The console protects cold draft from windows to provide comfortable environment.



5-Step Vane Control

There are 5 different stages to control air flow direction.

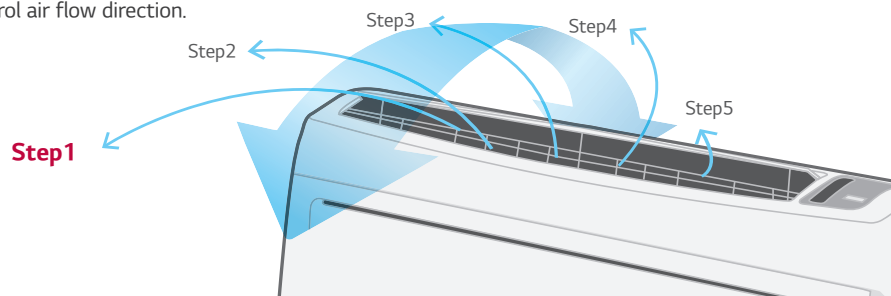

6 Way Flexible Piping

It is possible to install and connect the outdoor unit in 6 different ways. (Right Side, Right Back, Right Floor, Left Side, Left Back, Left Floor)

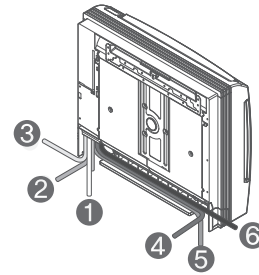

Protect Cold Draft

The floor standing unit protects cold draft coming from window and preventing condensation.

Without Floor Standing

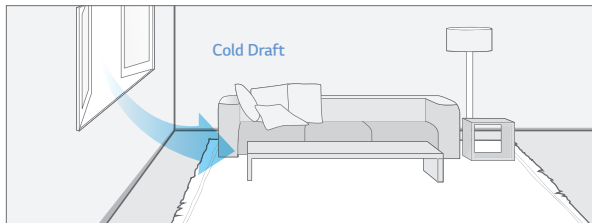

With Floor Standing

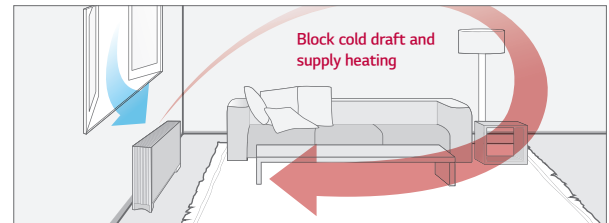

3 Way Flexible Piping

It is possible to install and connect the outdoor unit in 3 different ways. (Side, Back, Floor)

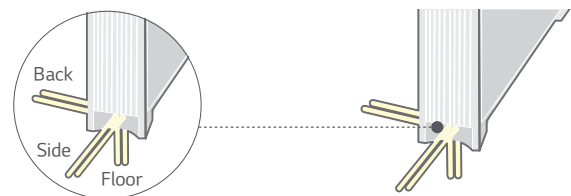

Sliding Type Filter

Easy maintenance and extended product life with sliding type filter.

Sliding type

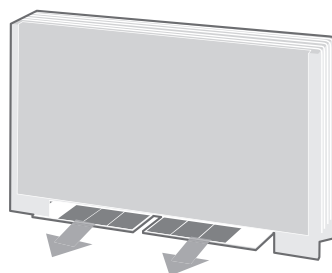

Easy cleaning

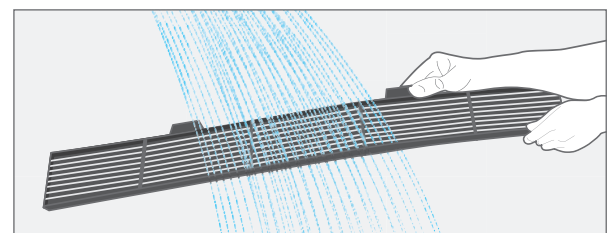

ARNU07GQAA4 / ARNU09GQAA4



MODEL		UNIT	ARNU07GQAA4	ARNU09GQAA4
Cooling Capacity		kW	2.2	2.8
Heating Capacity		kW	2.5	3.2
Power Input (H / M / L) Nominal		W	15 / 12 / 10	15 / 12 / 10
Exterior Color			Morning Fog	Morning Fog
RAL Code			RAL 9001	RAL 9001
Dimensions (W x H x D)	Body	mm	700 x 600 x 210	700 x 600 x 210
	Shipping	mm	775 x 662 x 284	775 x 662 x 284
Fan	Type		Turbo fan	Turbo fan
	Motor Output x Number	W x No.	48 x 1	48 x 1
	Air Flow Rate (H / M / L)	m ³ /min	6.7 / 5.9 / 4.8	6.7 / 5.9 / 4.8
	Motor Type		BLDC	BLDC
Air Filter			Pre Filter	Pre Filter
Pipe Connections	Liquid Side	mm (inch)	Ø6.35 (1/4)	Ø6.35 (1/4)
	Gas Side	mm (inch)	Ø12.7 (1/2)	Ø12.7 (1/2)
	Drain Pipe (Internal Dia.)	mm (inch)	Ø12 (15/32)	Ø12 (15/32)
Weight	Body	kg	14.0	14.0
Sound Pressure Levels (H / M / L)		dB(A)	37 / 34 / 28	37 / 34 / 28
Sound Power Levels (H / M / L)		dB(A)	53 / 50 / 44	53 / 50 / 44
Power Supply		Ø, V, Hz	1, 220-240, 50	1, 220-240, 50
Transmission Cable		mm ²	1.0 ~ 1.5 x 2C	1.0 ~ 1.5 x 2C

Note :

- Performance tested under EN14511
- Capacities are based on the following conditions
 - Cooling : Indoor temp. 27°C (80.6°F) DB / 19°C (66.2°F) WB, Outdoor temp. 35°C (95°F) DB / 24°C (75.2°F) WB, Interconnecting piping length 7.5m, Level difference of zero
 - Heating : Indoor temp. 20°C (68°F) DB / 15°C (59°F) WB, Outdoor temp. 7°C (44.6°F) DB / 6°C (42.8°F) WB, Interconnecting piping length 7.5m, Level difference of zero
- Due to our policy of innovation, some specifications may be changed without notification

Accessories

CHASSIS	ARNU07GQAA4	ARNU09GQAA4
Drain Pump		-
Cassette Cover		-
Refrigerant Leakage Detector		PRLDNV50 (R410a)
EEV Kit		PRGK024A0
Multi-tenant Power Module		PINPMB001
Robot Cleaner		-
Pre Filter (Washable)		○
Ion Generator		○
CO ₂ Sensor		-
Ventilation Kit		-
IR Receiver		-
Zone Controller		-
Dry Contact (with additional accessory)		PDRYCB000 (1 point contact), PDRYCB320, PDRYCB400 (2 points input), PDRYCB500 (Modbus)
External Input (1 point)		○
Wi-Fi		PWFMD200

※ ○ : Applied, - : Not Applied
Option: Refer to model name in table

ARNU12GQAA4 / ARNU15GQAA4



MODEL		UNIT	ARNU12GQAA4	ARNU15GQAA4
Cooling Capacity		kW	3.6	4.5
Heating Capacity		kW	4.0	5.0
Power Input (H / M / L)	Nominal	W	18 / 15 / 13	24 / 19 / 17
Exterior Color			Morning Fog	Morning Fog
RAL Code			RAL 9001	RAL 9001
Dimensions (W x H x D)	Body	mm	700 x 600 x 210	700 x 600 x 210
	Shipping	mm	775 x 662 x 284	775 x 662 x 284
Fan	Type		Turbo fan	Turbo fan
	Motor Output x Number	W x No.	48 x 1	48 x 1
	Air Flow Rate (H / M / L)	m ³ /min	7.5 / 5.9 / 4.8	8.7 / 6.7 / 5.9
	Motor Type		BLDC	BLDC
Air Filter			Pre Filter	Pre Filter
Pipe Connections	Liquid Side	mm (inch)	Ø6.35 (1/4)	Ø6.35 (1/4)
	Gas Side	mm (inch)	Ø12.7 (1/2)	Ø12.7 (1/2)
	Drain Pipe (Internal Dia.)	mm (inch)	Ø12 (15/32)	Ø12 (15/32)
Weight	Body	kg	14.0	14.0
Sound Pressure Levels (H / M / L)		dB(A)	39 / 34 / 28	42 / 37 / 31
Sound Power Levels (H / M / L)		dB(A)	56 / 50 / 44	58 / 53 / 50
Power Supply		Ø, V, Hz	1, 220-240, 50	1, 220-240, 50
Transmission Cable		mm ²	1.0 ~ 1.5 x 2C	1.0 ~ 1.5 x 2C

Note :

- Performance tested under EN14511
- Capacities are based on the following conditions
 - Cooling : Indoor temp. 27°C (80.6°F) DB / 19°C (66.2°F) WB, Outdoor temp. 35°C (95°F) DB / 24°C (75.2°F) WB, Interconnecting piping length 7.5m, Level difference of zero
 - Heating : Indoor temp. 20°C (68°F) DB / 15°C (59°F) WB, Outdoor temp. 7°C (44.6°F) DB / 6°C (42.8°F) WB, Interconnecting piping length 7.5m, Level difference of zero
- Due to our policy of innovation, some specifications may be changed without notification

Accessories

CHASSIS	ARNU12GQAA4	ARNU15GQAA4
Drain Pump		-
Cassette Cover		-
Refrigerant Leakage Detector		PRLDNVSO (R410a)
EEV Kit		PRGK024A0
Multi-tenant Power Module		PINPMB001
Robot Cleaner		-
Pre Filter (Washable)		○
Ion Generator		○
CO ₂ Sensor		-
Ventilation Kit		-
IR Receiver		-
Zone Controller		-
Dry Contact (with additional accessory)		PDRYCB000 (1 point contact), PDRYCB320, PDRYCB400 (2 points input), PDRYCB500 (Modbus)
External Input (1 point)		○
Wi-Fi		PWFMD200

※ ○ : Applied, - : Not Applied
Option: Refer to model name in table

ARNU07GCEA4 / ARNU09GCEA4
ARNU12GCEA4 / ARNU15GCEA4
ARNU18GCFA4 / ARNU24GCFA4



※ A : Floor Standing with case

MODEL		UNIT	ARNU07GCEA4	ARNU09GCEA4	ARNU12GCEA4	ARNU15GCEA4	ARNU18GCFA4	ARNU24GCFA4
Cooling Capacity		kW	2.2	2.8	3.6	4.5	5.6	7.1
Heating Capacity		kW	2.5	3.2	4.0	5.0	6.3	8.0
Power Input (H / M / L) Nominal		W	24 / 17 / 14	30 / 24 / 17	36 / 30 / 24	44 / 35 / 28	54 / 41 / 29	84 / 54 / 41
Exterior Color			Morning Fog	Morning Fog	Morning Fog	Morning Fog	Morning Fog	Morning Fog
RAL Code			RAL 9001	RAL 9001	RAL 9001	RAL 9001	RAL 9001	RAL 9001
Dimensions (W x H x D)	Body	mm	1,067 x 635 x 203	1,067 x 635 x 203	1,067 x 635 x 203	1,067 x 635 x 203	1,345 x 635 x 203	1,345 x 635 x 203
	Shipping	mm	1,154 x 705 x 289	1,154 x 705 x 289	1,154 x 705 x 289	1,154 x 705 x 289	1,432 x 705 x 289	1,432 x 705 x 289
Fan	Type		Sirocco Fan	Sirocco Fan	Sirocco Fan	Sirocco Fan	Sirocco Fan	Sirocco Fan
	Motor Output x Number	W x No.	19 x 1, 5 x 1	19 x 1, 5 x 1	19 x 1, 5 x 1	19 x 1, 5 x 1	19 x 2	19 x 2
	Air Flow Rate (H / M / L)	m ³ /min	8.5 / 7.5 / 6.5	9.5 / 8.5 / 7.5	10.5 / 9.5 / 8.5	11.5 / 10.0 / 9.5	16.0 / 14.0 / 12.0	18.0 / 16.0 / 14.0
	Motor Type		BLDC	BLDC	BLDC	BLDC	BLDC	BLDC
Air Filter			Pre Filter	Pre Filter	Pre Filter	Pre Filter	Pre Filter	Pre Filter
Pipe Connections	Liquid Side	mm (inch)	Ø6.35 (1/4)	Ø6.35 (1/4)	Ø6.35 (1/4)	Ø6.35 (1/4)	Ø6.35 (1/4)	Ø9.52 (3/8)
	Gas Side	mm (inch)	Ø12.7 (1/2)	Ø12.7 (1/2)	Ø12.7 (1/2)	Ø12.7 (1/2)	Ø12.7 (1/2)	Ø15.88 (5/8)
	Drain Pipe (Internal Dia.)	mm (inch)	Ø12 (15/32)	Ø12 (15/32)	Ø12 (15/32)	Ø12 (15/32)	Ø12 (15/32)	Ø12 (15/32)
Weight	Body	kg	27.0	27.0	27.0	27.0	34.0	34.0
Sound Pressure Levels (H / M / L)		dB(A)	35 / 33 / 31	36 / 34 / 32	37 / 35 / 33	38 / 37 / 35	40 / 37 / 34	43 / 40 / 37
Sound Power Levels (H / M / L)		dB(A)	52 / 47 / 43	54 / 51 / 47	54 / 51 / 50	55 / 54 / 51	57 / 54 / 50	61 / 57 / 54
Power Supply		Ø, V, Hz	1, 220-240, 50	1, 220-240, 50	1, 220-240, 50	1, 220-240, 50	1, 220-240, 50	1, 220-240, 50
Transmission Cable		mm ²	1.0 ~ 1.5 x 2C	1.0 ~ 1.5 x 2C	1.0 ~ 1.5 x 2C	1.0 ~ 1.5 x 2C	1.0 ~ 1.5 x 2C	1.0 ~ 1.5 x 2C

Note :

1. Performance tested under EN14511

2. Capacities are based on the following conditions

- Cooling : Indoor temp. 27°C (80.6°F) DB / 19°C (66.2°F) WB, Outdoor temp. 35°C (95°F) DB / 24°C (75.2°F) WB, Interconnecting piping length 7.5m, Level difference of zero

- Heating : Indoor temp. 20°C (68°F) DB / 15°C (59°F) WB, Outdoor temp. 7°C (44.6°F) DB / 6°C (42.8°F) WB, Interconnecting piping length 7.5m, Level difference of zero

3. Due to our policy of innovation, some specifications may be changed without notification

Accessories

CHASSIS	ARNU07GCEA4	ARNU09GCEA4	ARNU12GCEA4	ARNU15GCEA4	ARNU18GCFA4	ARNU24GCFA4
Drain Pump			-			-
Cassette Cover			-			-
Refrigerant Leakage Detector		PRLDNVSO (R410a)			PRLDNVSO (R410a)	
EEV Kit		PRGK024A0				-
Multi-tenant Power Module		PINPMB001			PINPMB001	
Robot Cleaner			-			-
Pre Filter (Washable)			○			○
Ion Generator			-			-
CO ₂ Sensor			-			-
Ventilation Kit			-			-
IR Receiver		PWLRVN000			PWLRVN000	
Zone Controller			-			-
Dry Contact (with additional accessory)			PDRYCB000 (1 point contact), PDRYCB320, PDRYCB400 (2 points input), PDRYCB500 (Modbus)			
External Input (1 point)			○			○
Wi-Fi		PWFMDD200			PWFMDD200	

※ ○ : Applied, - : Not Applied

Option: Refer to model name in table

**ARNU07GCEU4 / ARNU09GCEU4
ARNU12GCEU4 / ARNU15GCEU4
ARNU18GCFU4 / ARNU24GCFU4**



※ U : Floor Standing without case

MODEL		UNIT	ARNU07GCEU4	ARNU09GCEU4	ARNU12GCEU4	ARNU15GCEU4	ARNU18GCFU4	ARNU24GCFU4
Cooling Capacity		kW	2.2	2.8	3.6	4.5	5.6	7.1
Heating Capacity		kW	2.5	3.2	4.0	5.0	6.3	8.0
Power Input (H / M / L)	Nominal	W	24 / 17 / 14	30 / 24 / 17	36 / 30 / 24	44 / 35 / 28	54 / 41 / 29	84 / 54 / 41
Dimensions (W x H x D)	Body	mm	978 x 639 x 190	978 x 639 x 190	978 x 639 x 190	978 x 639 x 190	1,256 x 639 x 190	1,256 x 639 x 190
	Shipping	mm	1,055 x 702 x 260	1,055 x 702 x 260	1,055 x 702 x 260	1,055 x 702 x 260	1,333 x 702 x 260	1,333 x 702 x 260
Fan	Type		Sirocco Fan	Sirocco Fan	Sirocco Fan	Sirocco Fan	Sirocco Fan	Sirocco Fan
	Motor Output x Number	W x No.	19 x 1, 5 x 1	19 x 1, 5 x 1	19 x 1, 5 x 1	19 x 1, 5 x 1	19 x 2	19 x 2
	Air Flow Rate (H / M / L)	m ³ /min	8.5 / 7.5 / 6.5	9.5 / 8.5 / 7.5	10.5 / 9.5 / 8.5	11.5 / 10.0 / 9.5	16.0 / 14.0 / 12.0	18.0 / 16.0 / 14.0
	Motor Type		BLDC	BLDC	BLDC	BLDC	BLDC	BLDC
Air Filter			Pre Filter	Pre Filter	Pre Filter	Pre Filter	Pre Filter	Pre Filter
Pipe Connections	Liquid Side	mm (inch)	Ø6.35 (1/4)	Ø6.35 (1/4)	Ø6.35 (1/4)	Ø6.35 (1/4)	Ø6.35 (1/4)	Ø9.52 (3/8)
	Gas Side	mm (inch)	Ø12.7 (1/2)	Ø12.7 (1/2)	Ø12.7 (1/2)	Ø12.7 (1/2)	Ø12.7 (1/2)	Ø15.88 (5/8)
	Drain Pipe (Internal Dia.)	mm (inch)	Ø12 (15/32)	Ø12 (15/32)	Ø12 (15/32)	Ø12 (15/32)	Ø12 (15/32)	Ø12 (15/32)
Weight	Body	kg	20.0	20.0	20.0	20.0	26.0	26.0
Sound Pressure Levels (H / M / L)		dB(A)	35 / 33 / 31	36 / 34 / 32	37 / 35 / 33	38 / 37 / 35	40 / 37 / 34	43 / 40 / 37
Sound Power Levels (H / M / L)		dB(A)	52 / 47 / 43	54 / 51 / 47	54 / 51 / 50	55 / 54 / 51	57 / 54 / 50	61 / 57 / 54
Power Supply		Ø, V, Hz	1, 220-240, 50	1, 220-240, 50	1, 220-240, 50	1, 220-240, 50	1, 220-240, 50	1, 220-240, 50
Transmission Cable		mm ²	1.0 ~ 1.5 x 2C	1.0 ~ 1.5 x 2C	1.0 ~ 1.5 x 2C	1.0 ~ 1.5 x 2C	1.0 ~ 1.5 x 2C	1.0 ~ 1.5 x 2C

Note :

1. Performance tested under EN14511

2. Capacities are based on the following conditions

- Cooling : Indoor temp. 27°C (80.6°F) DB / 19°C (66.2°F) WB, Outdoor temp. 35°C (95°F) DB / 24°C (75.2°F) WB, Interconnecting piping length 7.5m, Level difference of zero

- Heating : Indoor temp. 20°C (68°F) DB / 15°C (59°F) WB, Outdoor temp. 7°C (44.6°F) DB / 6°C (42.8°F) WB, Interconnecting piping length 7.5m, Level difference of zero

3. Due to our policy of innovation, some specifications may be changed without notification

Accessories

CHASSIS	ARNU07GCEU4	ARNU09GCEU4	ARNU12GCEU4	ARNU15GCEU4	ARNU18GCFU4	ARNU24GCFU4
Drain Pump			-			-
Cassette Cover			-			-
Refrigerant Leakage Detector		PRLDNVSO (R410a)			PRLDNVSO (R410a)	
EEV Kit		PRGK024A0				-
Multi-tenant Power Module		PINPMB001				PINPMB001
Robot Cleaner			-			-
Pre Filter (Washable)			○			○
Ion Generator			-			-
CO ₂ Sensor			-			-
Ventilation Kit			-			-
IR Receiver		PWLRVN000				PWLRVN000
Zone Controller			-			-
Dry Contact (with additional accessory)			PDRYCB000 (1 point contact), PDRYCB320, PDRYCB400 (2 points input), PDRYCB500 (Modbus)			
External Input (1 point)			○			○
Wi-Fi		PWFMD200				PWFMD200

※ ○ : Applied, - : Not Applied

Option: Refer to model name in table



Features & Benefits

- The powerful air speed and volume means the air flow can reach up to 20m away from the air conditioner

Key Applications

- Factory
- Retail
- Shop
- Office
- Restaurant

FLOOR STANDING (PAC)		FLOOR STANDING (PAC)	
Smart	Wi-Fi*		○
Energy Efficiency	Jet Cool		○
Health	Ionizer		-
Fast Cooling & Heating	Jet Cool		○
	Sleep Mode		○
Comfort	Timer (On / Off)		○
	Timer (Weekly)		-
	Two Thermistor Control		○
	Group Control		○

※ ○: Applied, - : Not applied
 * Extra module is necessary for Wi-fi (module: PWFMD200)

Stylish Design

The new LG floor standing air conditioner which is Red Dot design award winner 2013, is ideal for modern interiors in your home or office.



reddot design award
winner 2013



Powerful Air Flow

The new LG floor standing air conditioner is efficient for using in large areas due to its powerful cooling and heating operation. The powerful air speed and volume means the air flow can reach up to 20m away from the air conditioner.

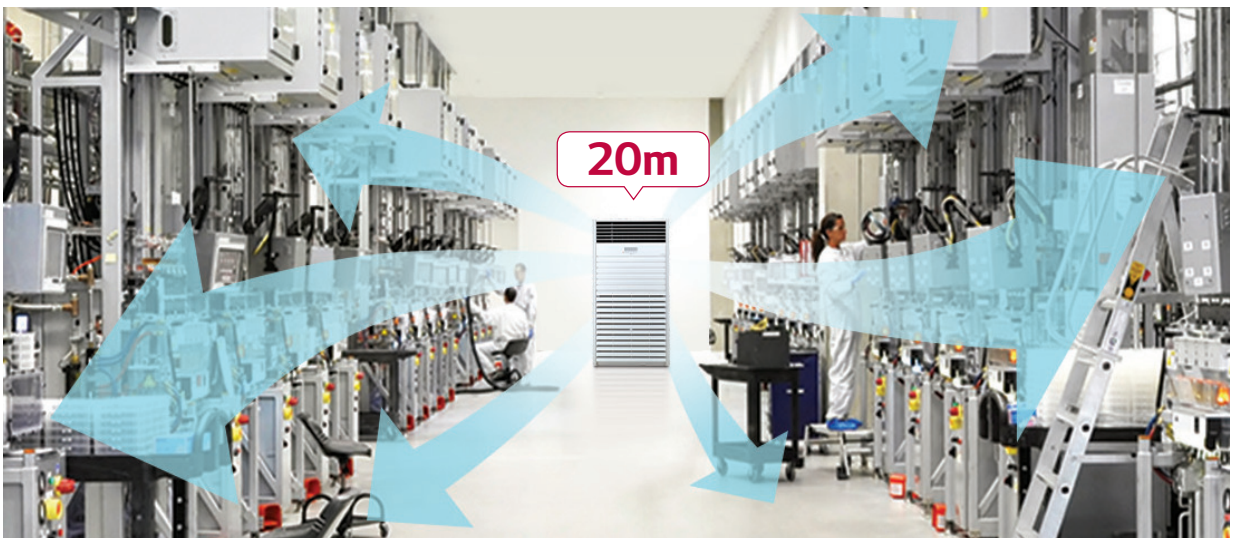

ARNU48GPTA4 / ARNU96GPFA4





















MODEL	UNIT	ARNU48GPTA4	ARNU96GPFA4
Cooling Capacity	kW	14.1	28.0
Heating Capacity	kW	15.9	31.5
Power Input	Cooling (SH / H / M / L)	260 / 190 / 140 / 110	400 / 280 / - / 180
	Heating (SH / H / M / L)	260 / 190 / 140 / 110	400 / 280 / - / 180
FLA (Full Load Ampere)	A	1.3	2.3
Casing		Galvanized Steel Plate	
Dimensions (WxHxD)	Body	590 × 1,840 × 440	1,050 × 1,880 × 495
	Rows × Columns × FPI	3 × 38 × 19	3 × 40 × 19
Coil	Face Area	0.39	0.77
	Type	Blower Fan	Blower Fan
Fan	Motor Output x Number	224 × 1	700 × 1
	Air Flow Rate (SH / H / M / L) (Standard Mode)	37 / 33 / 28 / 24	68 / 61 / - / 50
	Drive	Direct	
	Motor Type	BLDC	
	Temperature Control	Microprocessor, Thermostat for cooling and heating	
Sound Absorbing Thermal Insulation Material		Foamed polystyrene	
Air Filter		-	-
Safety Device		Fuse	
Pipe Connections	Liquid Side	9.52 (3/8)	9.52 (3/8)
	Gas Side	15.88 (5/8)	22.2 (7/8)
	Drain(ID)	19	22
Net Weight	kg (lbs)	48 (105.8)	103 (227.0)
Sound Pressure Level (SH / H / M / L)	dB (A)	54 / 51 / 49 / 45	60 / 57 / - / 53
Power Supply	Ø, V, Hz	1, 220, 60	1, 220, 60
	Ø, V, Hz	1, 220-240, 50	1, 220-240, 50
Refrigerant Control		EEV	
Communication Cable	mm ² (VCTF-SB)	1.0-1.5 × 2C	1.0-1.5 × 2C

NO.	NEW FUNCTION NAME (4 TH GENERATION INDOOR)	FUNCTION DESCRIPTION	REQUIRED CONTROLLER		REMARKS
			WIRED REMOTE CONTROLLER	CENTRALIZED CONTROLLER	
1	Energy Monitoring (Accumulated Electric Energy Check)	Monitoring accumulated power consumption by Wired Remote Controller	○	○	* Necessary to install the PDI (Power Distribution Indicator) and central controller * Combined with Multi V Water S outdoor unit, this function is not available.
		Monitoring accumulated power consumption by Central Control Device / PDI	-	○	* Necessary to install the PDI (Power Distribution Indicator) * To make a report, central controller must be installed
2	2 Set Point	1) 2 set point control by Indoor and central controller 2) Synchronization function with remote control (Synchronization Setting and Monitoring)	○	○	* Wired remote controller and central controller must be installed * Combined with Multi V Water S outdoor unit, this function is not available.
3	Occupied / Unoccupied Scheduling Function (Sub Func. Enable)	1) Synchronization according to occupied / unoccupied by Indoor and Central control 2) Synchronization icon with remote controller (Synchronization Monitoring)	○	○	* Centralized control is able to when you combine only 4th generation indoor units (Use together with 2nd generation and 4th generation indoors, only wired remote controller is able to set this function as existing way) * Wired remote controller or central controller must be installed (Function can be activated using just one control device.) * Combined with Multi V Water S outdoor unit, this function is not available.
4	Group Control	Group Control can use Additional function	○	○	* Check more details in PDB (Product Data Book) * Central controller can create and control group.
5	Test Run (Heating)	Test run mode can be operated in cooling mode and heating mode for easy service	○	-	
6	Model Information Monitoring	Product Type / Indoor Type / Indoor capacity information can be monitored by remote controller	○	-	
7	Indoor unit address checking	Wired remote controller can check indoor unit address information	○	-	
8	Refrigerant Leakage Detection	Function error sign display when refrigerant leakage occurred	○	○	* Central controller has been installed, CH230 error code can be recognized (Old / New Same) * Without Central Controller, it is able to recognize with wired remote controller (CH230) * Combined with Multi V Water S outdoor unit, this function is not available. * Accessory PRLDNV50 must be separately ordered
9	Thermo On / Off range Setting (Cooling)	User can set cooling thermo on/off range with wired remote controller for prevention overcooling	○	-	* Thermo On / Off temperature setting (3 step)
10	Thermo On / Off range Setting (Heating)	User can set heating thermo on/off range with wired remote controller for prevention overheating. (4 Step)	○	-	* Thermo On / Off temperature setting (4 step)
11	Static Pressure 11 Step Control (Only for Ceiling Concealed Duct Type)	Depends on the installation environment, 4th generation Ceiling Concealed Duct can control the static pressure by 11 steps for providing comfortable environment	○	-	* Only applied in Ceiling Concealed Duct
12	1 point External Input (On / Off control)	Indoor unit can be controlled by external devices without purchasing Dry contact as an accessory (All 4th generation indoors)	○	-	* Simple On/Off control by Dry Contact at Indoor [Example of Contact port by product type] * 2 Way Cassette : CN-CC Port (Wired remote controller installation function mode 41 is required) * 1 Way / 4 Way Cassette / Ceiling Concealed Duct / Wall Mounted Unit / Console / FAU / Floor Standing (with case / without case) : CN-EXT Port
13	Filter Sign (Remaining Time)	The alarm activates when the filter needs to be cleaned, and the time remaining for cleaning is displayed on the screen.	○	○	* The alarm activates on the central controller, but the remaining time is not displayed.
14	Auto restart function Disable / Enable	After the power failure compensation, stand by at OFF mode Restore the operation for the status before the power off	○	-	
15	Indoor Humidity display	Monitoring indoor humidity Wired Remote Controller	○	○	* Available only with Multi V <i>i</i>
16	Comfort Cooling setting	set the outdoor unit comfort cooling operation value	○	○	* Available only with Multi V <i>i</i>
17	Smart Load Control setting	Change the outdoor unit's Smart Load Control stage value.	○	○	* Available only with Multi V <i>i</i>
18	ODU Refrigerant Noise Reduction setting	set the outdoor unit's refrigerant noise reduction function	○	○	* Available only with Multi V <i>i</i>
19	Low noise mode time setting	set the start and end time of the outdoor unit's low noise mode operation	○	○	* Available only with Multi V <i>i</i>

Note : 1) No.1, 2, 3, 8 : Functions are available to use together with 4th generation Indoor units only. If used together 2nd generation indoor unit and 4th generation indoor unit functions will not be activate. Combined with MULTI V Water S outdoor unit this function is not available
 2) No. 4, 5, 6, 7, 9, 10, 11, 12, 13, 14 : If used together 2nd generation indoor unit and 4th generation indoor unit these functions will be activate only in 4th generation indoor
 3) 2nd generation indoor unit : Ceiling & Floor Convertible Unit, Ceiling Suspended Unit, HYDRO KIT (Low Temp. / High Temp.), ERV DX (with Humidifier, without Humidifier), AHU Communication Kit

WIRED REMOTE CONTROLLER					CENTRALIZED CONTROLLER				
PREMIUM (PREMTA000 PREMTA000A PREMTA000B)	STANDARD III (PREMTB100 PREMTBB10)	STANDARD II (PREMTBB01 PREMTB001)	SIMPLE		AC EZ (PQCSZ250S0)	AC EZ TOUCH (PACEZA000)	AC SMART 5 (PACS5A000)	ACP 5 (PACP5A000)	AC MANAGER 5 (PACM5A000)
			SIMPLE FOR HOTEL (PQRCHCA0Q / QW)	SIMPLE (PQRCVCL0Q / QW)					
○	○	○	-	-	-	○	○	○	○
-	-	-	-	-	-	○	○	○	○
○	○	-	-	-	-	○	○	○	○
○	○	-	-	-	-	○	○	○	○
○	○	○	-	-	-	-	○	○	○
○	○	○	-	-	-	-	-	-	-
○	○	○	-	-	-	-	-	-	-
○	○	○	-	-	-	-	-	-	-
○	○	○	-	-	-	-	○	○	-
○	○	○	-	-	-	-	-	-	-
○ (4 step)	○ (4 step)	○ (3 step)	○ (3 step)	○ (3 step)	-	-	-	-	-
○	○	○	○	○	-	-	-	-	-
○	○	○	-	-	-	-	-	-	-
○	○	○	-	-	○	○	○	○	○
○	○	○	-	-	-	-	-	-	-
○	○	-	-	-	-	-	○	○	-
○	○	-	-	-	-	-	○	○	-
○	○	-	-	-	-	-	○	○	-
○	○	-	-	-	-	○	○	○	-

※ ○ : Applied, - : Not applied

Controller Product		Premium	Standard III	Standard II	Simple	Simple for Hotel	Wireless	Dry Contact						
		PREMTA000 PREMTA000A PREMTA000B	PREMTBB10	PREMTB100	PREMTBB01	PREMTB001	PQRCVCL0Q	PQRCVCL0QW	PQRCHCA0Q	PQRCHCA0QW	PWLSSB21H (H/P)	Simple Dry Contact PDRYCB000	2 points Dry Contact PDRYCB400	Dry Contact for Thermostat PDRYCB320
MULTI V	 ARNU-A4 ARNU-B4 4 Way	○	○	○	○	○	○	○	○	○	○	○	○	○
	 ARNU-B4 ARNU-C4 2 Way / 1 Way	○	○	○	○	○	○	○	○	○	○	○	○	○
	 ARNU-A4	○	○	○	○	○	○	○	○	○	○	○	○	○
	 ARNU-A4	○	○	○	○	○	○	△	○	○	○	○	○	○
	 ARNU-A4	○	○	○	○	○	○	△	○	○	○	○	○	○
	 ARNU-G4	○	○	○	○	○	○	△	○	○	○	○	○	○
	 ARNU-Z4	○	○	○	○	○	○	△	○	○	○	○	○	○
	 ARNU-A4	○	○	○	○	○	○	○	○	○	○	○	○	○
	 ARNU-A4	○	○	○	○	○	○	○	○	○	○	○	○	○
	 ARNU-A4	○	○	○	○	○	○	○	○	○	○	○	○	○
 ARNU-A4 ARNU-U4	○	○	○	○	○	○	○	○	○	○	○	○	○	
 ARNU-A4	○	○	○	○	○	○	○	○	○	○	○	○	○	
 ARNU-A4	○	○	○	○	○	○	○	○	○	○	○	○	○	
 ARNU-A4 ARNU-C4 ARNU-N4	○	○	○	○	○	○	○	○	○	○	○	○	○	
 ARNH-A4	-	-	-	-	-	-	-	○	-	○	-	-	-	
 Energy Recovery Ventilator	○	○	○	-	-	-	○	-	-	○	-	-	○	
 Energy Recovery Ventilator with DX coil	○	○	○	-	-	-	○	-	-	○	-	-	○	
 AHU Communication Kit	○	○	○	-	-	-	△	-	-	-	-	-	-	

※ ○ : Compatible, △ : Need wired remote controller / IR receiver, - : Not compatible
1) It has a separate remote controller

Controller Name		Wired Remote Controller					Wireless Remote Controller	Wi-Fi Modem
		Premium	Standard III	Standard II	Simple	Simple (Hotel)		
Model Name								
		PREMTA000 PREMTA000A PREMTA000B	PREMTB100 PREMTBB10	PREMTB001 PREMTBB01	PQRCVCL0Q PQRCVCL0QW	PQRCHCA0Q PQRCHCA0QW	PWLSSB21H (H/P)	PWFMDD200
Basic	On / Off	○	○	○	○	○	○	○
	Fan Speed Control	○	○	○	○	○	○	○
	Temperature Setting	○	○	○	○	○	○	○
	Mode Change	○	○	○	○	-	○	○
	Auto Swing	○	○	○	○	○	○	○
	Vane Control (Louver Angle)	○	○	○	○	○	○	○
	E.S.P (External Static Pressure)	○	○	○	○	○	-	-
	Electric Failure Compensation	○	○	○	○	○	-	○
	Indoor Temperature Display	○	○	○	○	○	○	-
ALL Button Lock (Child Lock)	○	○	○	○	○	-	-	
Advanced	Schedule / Timer	Weekly - Yearly	Weekly - Yearly	Weekly	-	-	Sleep / On / Off	Weekly
	Additional Mode Setting ¹⁾	○	○	○	-	-	-	-
	Time Display	○	○	○	-	-	○	-
	Humid. Display	○	○	-	-	-	-	-
	Advanced Lock (mode, set point, set point range, on/off Lock)	Advanced Lock	Advanced Lock	-	-	-	-	-
	Filter Sign	○	○	○	-	-	-	-
	Energy Management ²⁾	○	○	○	-	-	-	-
	Dual Set Point	○	○	-	-	-	-	-
	Human Detection	-	○	-	-	-	-	-
Temp. Humidity Compensation	○	○	-	-	-	-	-	
Wi-Fi AP mode setting	○	○	○	○	○	○	-	
ETC	Operation Status LED	○	○	○	○	○	-	-
	Wireless Remote Controller Receiver	○ ³⁾	-	○ ³⁾	○ ³⁾	○ ³⁾	-	-
	Display	5 inch Color	4.3 inch Color	4.3 inch mono	2.6 inch mono	2.6 inch mono	2 inch mono	-
	Size (W x H x D, mm)	137 x 121 x 16.5	120 x 120 x 16	120 x 121 x 16	70 x 121 x 16	70 x 121 x 16	51 x 153 x 26	48 x 68 x 14
Black Control for Screen Saver	○	○	-	-	-	-	-	

※ ○ : Applied, - : Not Applied

1) It might not be indicated or operated at the partial product

2) Centralized control (PACEZA000 / PACSSA000 / PACPSA000 / PLNWKB000) and PDI (PQNUD1S40 / PPWRDB000) should be installed for this function

3) For ceiling type duct

Note

- Indoor unit should have functions requested by the controller

- If you need more detail, please refer to the manual of product. (<http://partner.lge.com>: Home > DocLibrary > Manual)

HOT WATER SOLUTION

190 ~ 199

HYDRO KIT





HYDRO KIT

Features & Benefits

- Lower operation cost compared to fossil fuel-based systems such as boilers.
- More energy saving through MULTI V heat recovery system.

Key Applications

- Where Hot Water is needed such as domestic Hot Water, underfloor heating, or radiator. Where cold water is needed such as Fan coil unit and chilled beam.

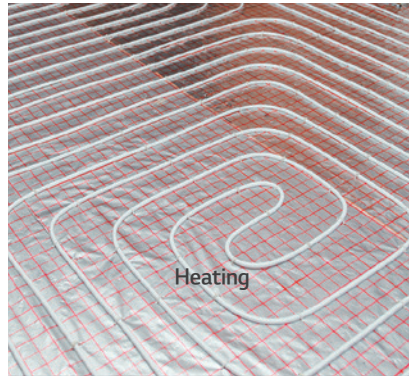

Radiant Heating / Cooling

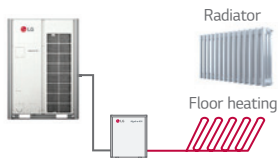

Fan Coil Unit Heating / Cooling

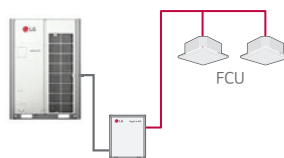

Hot Water / Cold Water

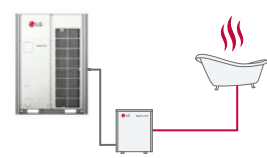

Combination



Hot water+ Underfloor heating

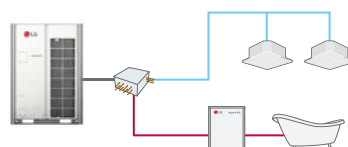

HR unit (Cooling & Hot water)

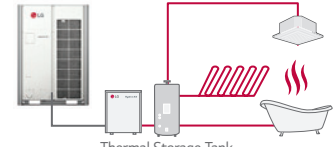

Thermal Storage System

Total Solution

Total solution provided with heat pump, air conditioning (Cooling by refrigerant and cold water / heating by refrigerant hot water) and domestic hot water supply.

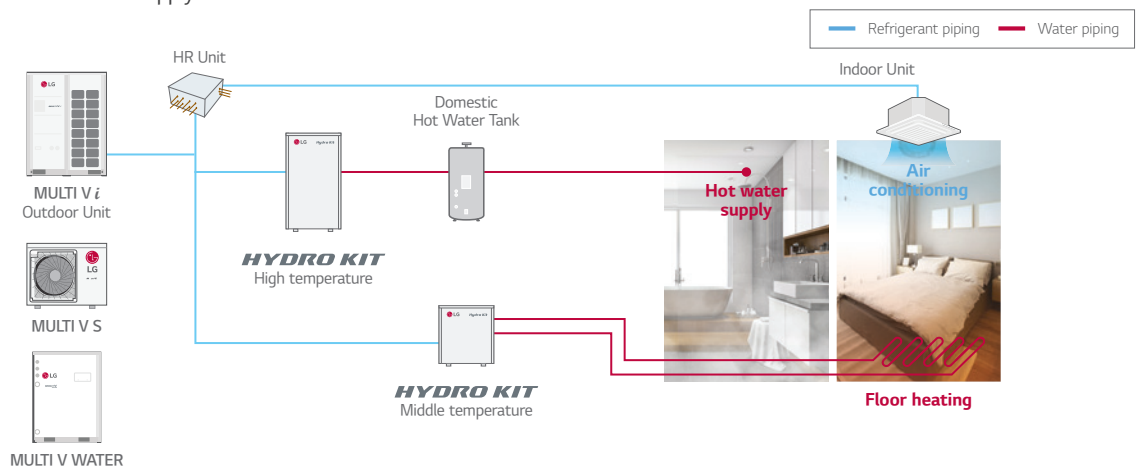

CONVENIENCE

High Temperature HYDRO KIT Cycle Diagram

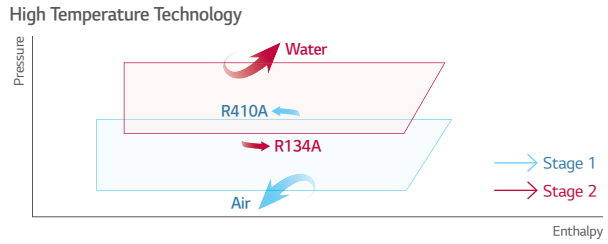
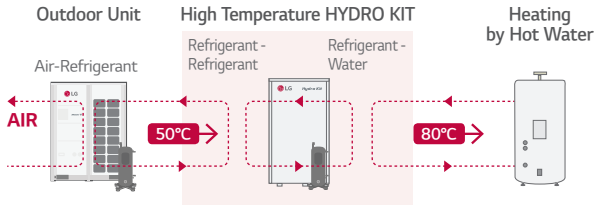

Various Applications

Applicable to a variety of facilities including hospitals, residences and resorts that need heating and domestic hot water supply.



Dormitory

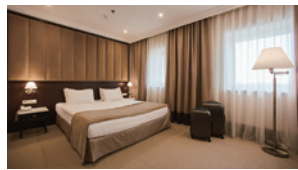

Hotel



Office



Restaurant



Fitness



Hospital



Factory



Residential

Hotel Application

Simultaneous cooling and heating operation during summer to produce hot water by using heat energy recovered from indoor cooling process.

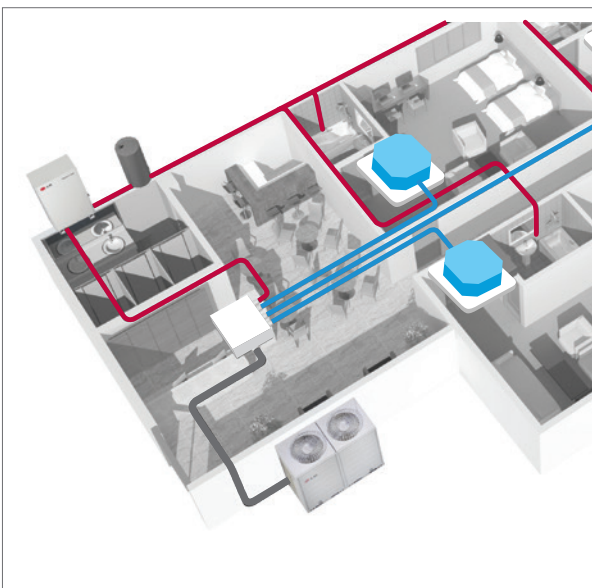

Office Application

The energy recovered from office cooling can be used to generate hot water for use in the offices.

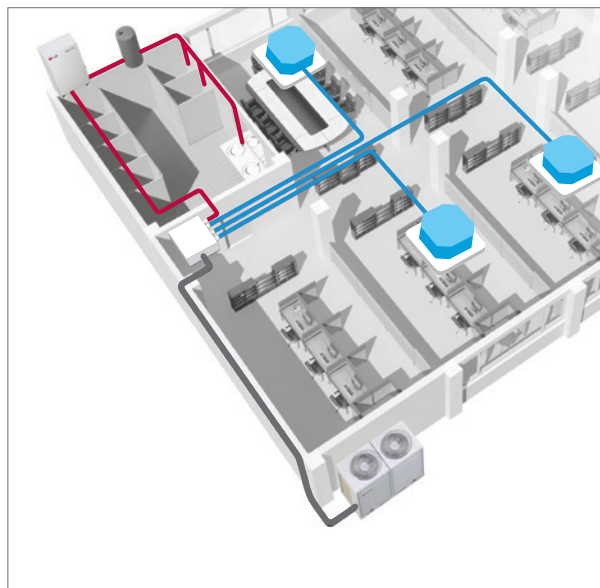

**ARNH18GK1A4 / ARNH24GK1A4
ARNH30GK1A4**



MODEL		UNIT	ARNH18GK1A4	ARNH24GK1A4	ARNH30GK1A4	
Power Supply	-	V, Ø, Hz	220-230-240, 1, 50/60	220-230-240, 1, 50/60	220-230-240, 1, 50/60	
Capacity (Rated)	Cooling	kW	5.6	7.1	9.0	
		kcal/h	4,800	6,100	7,700	
		Btu/h	19,100	24,200	30,700	
	Heating	kW	5.6	7.1	9.0	
		kcal/h	4,800	6,100	7,700	
		Btu/h	19,100	24,200	30,700	
Input (Rated)	Cooling	W	75	75	75	
	Heating	W	75	75	75	
Running Current (220 - 230 - 240V)	Cooling / Heating	A	0.70 - 0.67 - 0.64	0.70 - 0.67 - 0.64	0.70 - 0.67 - 0.64	
Casing	Material	-	Painted Steel Plate	Painted Steel Plate	Painted Steel Plate	
	RAL (Classic)	-	RAL 9003	RAL 9003	RAL 9003	
Dimensions	Net(W x H x D)	mm	490 x 850 x 315	490 x 850 x 315	490 x 850 x 315	
	Shipping(W x H x D)	mm	1,082 x 563 x 375	1,082 x 563 x 375	1,082 x 563 x 375	
Weight	Net	kg	42.0	42.0	42.0	
	Shipping	kg	47.0	42.0	42.0	
Heat Exchanger	Refrigerant to Water	Type	-	Brazed Plate HEX	Brazed Plate HEX	Brazed Plate HEX
		Quantity	EA	1	1	1
		Number of Plate	EA	54	54	54
		Water Volume	ℓ	0.7	0.7	0.7
		Rated Water Flow	ℓ/min	15.8	20.1	25.9
Head Loss		m	0.22	0.30	0.40	
Water Pump	Type	-	Canned type for hot water circulation	Canned type for hot water circulation	Canned type for hot water circulation	
	Model	-	GRUNDFOS UPM3K 20-75 CHBL	GRUNDFOS UPM3K 20-75 CHBL	GRUNDFOS UPM3K 20-75 CHBL	
	Motor Type	-	AC Motor	AC Motor	AC Motor	
	Steps of Pump Performance	-	Variable capacity 10% to 100%	Variable capacity 10% to 100%	Variable capacity 10% to 100%	
	Power input Min. - Max.	W	3 - 60	3 - 60	3 - 60	
Expansion Vessel	Volume	Max.	ℓ	8.0	8.0	8.0
	Water pressure	Max.	bar	3.0	3.0	3.0
	Water pressure	Pre-charged	bar	1.0	1.0	1.0
Strainer	Mesh size	-	28 mesh	28 mesh	28 mesh	
	Material	-	Stainless Steel	Stainless Steel	Stainless Steel	
Relief valve	Pressure Limit	Upper Limit	bar	3.0	3.0	3.0



MODEL		UNIT	ARNH18GK1A4	ARNH24GK1A4	ARNH30GK1A4	
Backup Heater	Type	-	Sheath	Sheath	Sheath	
	Number of Heating Coil	EA	2	2	2	
	Capacity Combination	kW	3.0 + 3.0	3.0 + 3.0	3.0 + 3.0	
	Operation	-	Automatic	Automatic	Automatic	
	Heating Steps	Step	2	2	2	
	Power Supply	V, Ø, Hz	220-240, 1, 50	220-240, 1, 50	220-240, 1, 50	
	FLA	A	31.0	31.0	31.0	
Power Cable (H07RN-F) (Included Eath)		mm2x cores	4.0 x 3C	4.0 x 3C	4.0 x 3C	
Flow Sensor	Type	-	Vortex	Vortex	Vortex	
	Model	-	SIKA VVX20	SIKA VVX20	SIKA VVX20	
	Measuring Range	Min. ~ Max.	ℓ/min	5 ~ 80	5 ~ 80	
	Flow (Trigger Point)	Min.	ℓ/min	7.0	7.0	
Temperature Control		-	Microprocessor, Thermostat for cooling and heating	Microprocessor, Thermostat for cooling and heating	Microprocessor, Thermostat for cooling and heating	
Water Tank Temperature Sensor	Type(Sensor Holder)	-	Male PT 1/2 inch	Male PT 1/2 inch	Male PT 1/2 inch	
	Length	m	12	12	12	
Sound Absorbing Thermal Insulation Material		-	Foamed polystrene	Foamed polystrene	Foamed polystrene	
Safety Device		-	Fuse	Fuse	Fuse	
Piping Connections	Water Side	Inlet	-	Male PT 1 inch	Male PT 1 inch	Male PT 1 inch
		Outlet	-	Male PT 1 inch	Male PT 1 inch	Male PT 1 inch
	Refrigerant Side	Liquid	mm(inch)	Ø 9.52 (3/8)	Ø 9.52 (3/8)	Ø 9.52 (3/8)
		Gas	mm(inch)	Ø 15.88 (5/8)	Ø 15.88 (5/8)	Ø 15.88 (5/8)
Power Cable Supply Cable (H07RN-F)		mm ² x cores	2.5 x 3C	2.5 x 3C	2.5 x 3C	
Communication Cable (VCTF-SB)		mm ² x cores	1.0-1.5 x 2C	1.0-1.5 x 2C	1.0-1.5 x 2C	
Sound Pressure Level	Cooling / Heating	Rated	dB(A)	35	35	
Sound Power Level	Cooling / Heating	Rated	dB(A)	44	44	

ARNH04GK2A4 / ARNH10GK2A4



MODEL		UNIT	ARNH04GK2A4	ARNH10GK2A4
Cooling Capacity		kW	12.3	28.0
Heating Capacity		kW	13.8	31.5
Power Input Nominal ¹⁾		W	10	10
Exterior Color			Morning Gray	Morning Gray
RAL Code			RAL 7030	RAL 7030
Dimensions (W x H x D)	Body	mm	520 x 631 x 330	520 x 631 x 330
	Shipping	mm	677 x 687 x 418	677 x 687 x 418
Pipe Connections	Liquid Side	mm (inch)	Ø9.52 (3/8)	Ø9.52 (3/8)
	Gas Side	mm (inch)	Ø15.88 (5/8)	Ø22.2 (7/8)
	Drain Pipe (Internal Dia.)	A (inch)	25A (Male PT 1)	25A (Male PT 1)
Water Pipe Connections	Inlet	A (inch)	25A (Male PT 1)	25A (Male PT 1)
	Outlet	A (inch)	25A (Male PT 1)	25A (Male PT 1)
Weight	Body	kg	29.2	33.7
Sound Pressure Levels (H / M / L)		dB(A)	26	26
Power Supply		Ø, V, Hz	1, 220-240, 50	1, 220-240, 50
Communication Cable		mm ² x No.	1.0 - 1.5 x 2C	1.0 - 1.5 x 2C

1) Nominal : Performance tested under EN14511

Note :

1. Capacities are based on the following conditions :

- Cooling : Indoor 27°C (80.6°F) DB / 19° C (66.2°F) WB, Outdoor 35°C (95°F) DB / 24°C (75.2°F) WB, Water Inlet 23°C (73.4°F) / Outlet 18°C (64.4°F)
- Heating : Indoor 20°C (68°F) DB / 15°C (59°F) WB, Outdoor 7°C (44.6°F) DB / 6°C (42.8°F) WB, Water Inlet 30°C (86°F) / Outlet 35°C (95°F)

2. Piping Length : Interconnected Pipe Length = 7.5m

3. Difference Limit of Elevation (Outdoor - Indoor Unit) is Zero.

4. MULTI V S 4HP (ARUN040GSS0, ARUN040LSS0) cannot be connected to Hydro Kit.

5. MULTI V Water S cannot be connected to Hydro Kit.

6. Anti freezing liquid should be added under 10°C (outdoor temp.) during cooling mode.

Accessories

CHASSIS	ARNH04GK2A4	ARNH10GK2A4
Drain Pump		-
Cassette Cover		-
Refrigerant Leakage Detector		PRLDNVSO
EEV Kit		-
Multi-tenant Power Module		○
Robot Cleaner		-
Pre Filter (Washable)		-
Ion Generator		-
CO ₂ Sensor		-
Ventilation Kit		-
IR Receiver		-
Zone Controller		-
Dry Contact (with additional accessory)		PDRYCB000 (1 point contact), PDRYCB320
External Input (1 point)		○
Wi-Fi		PWFMDD200

※ ○ : Applied, - : Not applied

Option : Refer to model name in table

ARNH04GK3A4 / ARNH08GK3A4



MODEL		UNIT	ARNH04GK3A4	ARNH08GK3A4
Heating Capacity		kW	13.8	25.2
Power Input Nominal ¹⁾		W	2,300	5,000
Exterior Color			Morning Gray	Morning Gray
RAL Code			RAL 7030	RAL 7030
Dimensions (W x H x D)	Body	mm	520 x 1,080 x 330	520 x 1,080 x 330
	Shipping	mm	682 x 1,168 x 423	682 x 1,168 x 423
Pipe Connections	Liquid Side	mm (inch)	Ø9.52 (3/8)	Ø9.52 (3/8)
	Gas Side	mm (inch)	Ø15.88 (5/8)	Ø19.05 (3/4)
	Drain Pipe (Internal Dia.)	A (inch)	25A (Male PT 1)	25A (Male PT 1)
Water Pipe Connections	Inlet	A (inch)	25A (Male PT 1)	25A (Male PT 1)
	Outlet	A (inch)	25A (Male PT 1)	25A (Male PT 1)
Weight	Body	kg	87.0	91.0
Sound Pressure Levels (H / M / L)		dB(A)	43	46
Power Supply		Ø, V, Hz	1, 220-240, 50	1, 220-240, 50
Communication Cable		mm ² x No.	1.0 - 1.5 x 2C	1.0 - 1.5 x 2C

1) Nominal : Performance tested under EN14511

Note :

1. Capacities are based on the following conditions :

- Heating : Indoor 20°C (68°F) DB / 15°C (59°F) WB, Outdoor 7°C (44.6°F) DB / 6°C (42.8°F) WB, Water Inlet 55°C (131°F) / Outlet 65°C (149°F)

2. Piping Length : Interconnected Pipe Length = 7.5m

3. Difference Limit of Elevation (Outdoor - Indoor Unit) is Zero.

4. MULTI V S 4HP (ARUN040GSS0, ARUN040LSS0) cannot be connected to Hydro Kit.

5. MULTI V Water S cannot be connected to Hydro Kit.

Accessories

CHASSIS	ARNH04GK3A4	ARNH08GK3A4
Drain Pump		-
Cassette Cover		-
Refrigerant Leakage Detector		PRLDNV50
EEV Kit		-
Multi-tenant Power Module		○
Robot Cleaner		-
Pre Filter (Washable)		-
Ion Generator		-
CO ₂ Sensor		-
Ventilation Kit		-
IR Receiver		-
Zone Controller		-
Dry Contact (with additional accessory)		PDRYCB000 (1 point contact), PDRYCB320
External Input (1 point)		○
Wi-Fi		PWFMD200

※ ○ : Applied, - : Not applied

Option : Refer to model name in table

VENTILATION SOLUTIONS

198 ~ 213

ERV / ERV WITH DX COIL
/ RESIDENTIAL ERV







Necessity of ERV

Energy Recovery Ventilation (ERV)

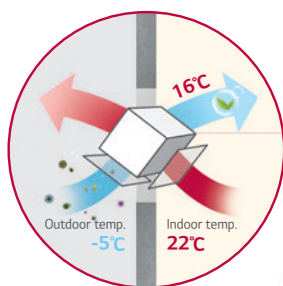

Comfort air + Energy Saving
 Compare to natural ventilation
 Heat exchanger collects wasted energy while ventilating.



24%
 Energy Saving

Natural Ventilation

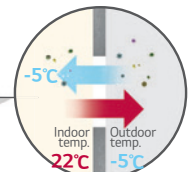

Natural Ventilation
 loss heat energy.

※ Comparing to ventilation without heat recovery. ERV vs. Natural Ventilation.

High Efficiency Heat Exchanger

Efficiency and comfort is ensured through the high-efficiency energy recovery central core which recovers energy from outgoing indoor air and transfers it to the fresh incoming air without mixing the air stream.

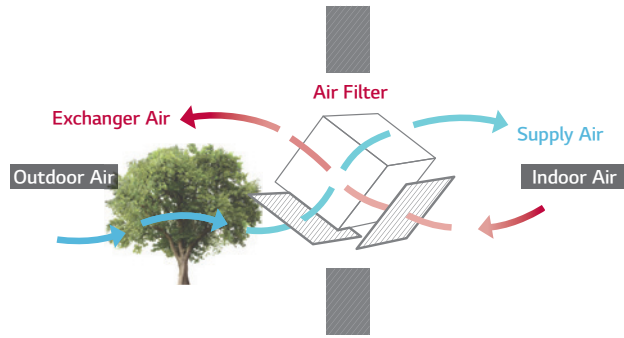

Cross Flow System

The exhaust system uses a high static sirocco fan to remove stale indoor air. Supply and exhaust air flows are completely separated in the heat exchanger, allowing the LG ERV to filter out particles before supplying outdoor air to ensure indoor air is fresh and healthy.

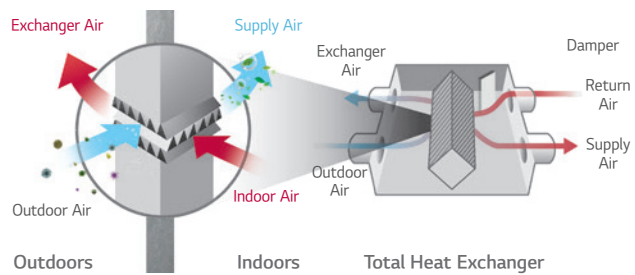

Night Time Free Cooling

During summer nights, indoor heat can be discharged outdoors and cool outdoor air can be brought indoors for energy savings.

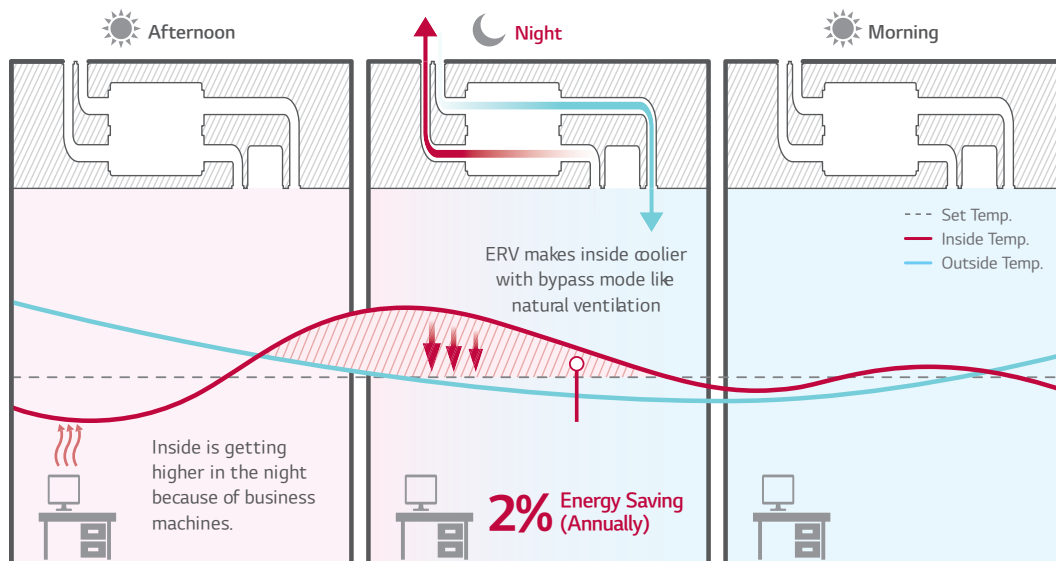

※ Comparing to if this Night Time Free Cooling function is not used.
 ※ This function is operated with 'Night Time Free Cooling' on remote controller. (with MULTI V only)
 ※ Energy saving ratio can be differed by weather condition.
 ※ Test Condition
 - Office (49,000ft²) / Occupancy : 30 / Area : London, UK
 - ERV (1000 CMH) + MULTI V 4 (1.2HP) Unit Combination
 - Other conditions are subject to BREEAM.

CO₂ Auto Operation

LG ERV reduces energy loss with auto fan speed control following CO₂ level.

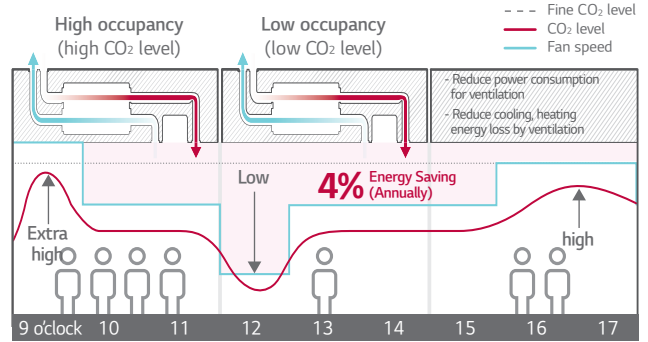

※ This function is operated with 'Night Time Free Cooling' on remote controller. (with MULTI V only)
 ※ Energy saving ratio can be differed by weather condition.
 ※ Test Condition - Office (49,000ft²) / Occupancy : 30 / Area : London, UK
 - ERV (1000 CMH) + MULTI V 4 (12HP) Unit Combination
 - Other conditions are subject to BREEAM

※ Comparing to if this CO₂ Auto Operation function is not used.

Seasonal Auto Operation

LG ERV senses outdoor temperature and operates automatically following weather conditions.

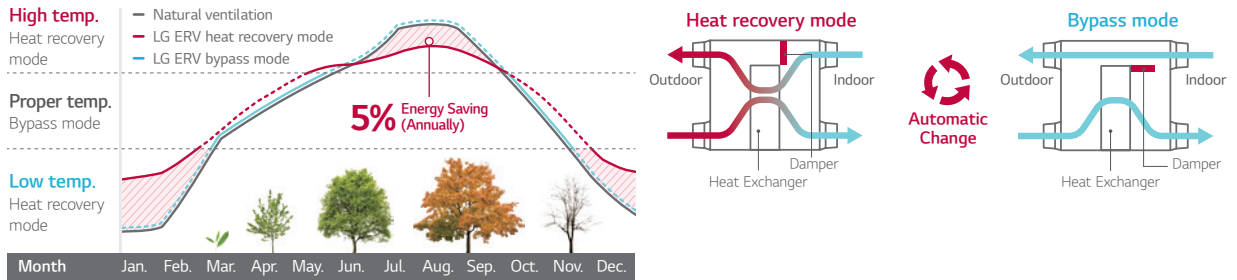

※ Comparing to if this Seasonal Auto Operation function is not used.
 ※ This function is operated with 'Auto' mode by wired remote control.
 ※ Energy saving ratio can be differed by weather condition.
 ※ Test Condition - Office (49,000ft²) / Occupancy : 30 / Area : London, UK
 - ERV (1,000 CMH) + MULTI V 4 (12HP) Unit Combination
 - Other conditions are subject to BREEAM

Delay Operation

When the air conditioner and ERV are switched on simultaneously, delay operation can reduce unnecessary heating and cooling energy loss by slowing down automatic ERV operation.

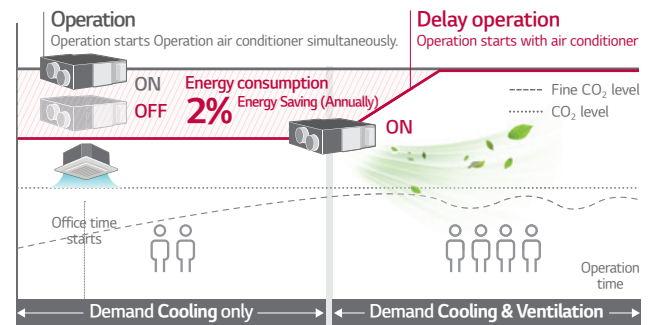

※ This function is operated with 'Night Time Free Cooling' on remote controller. (with MULTI V only)
 ※ Energy saving ratio can be differed by weather condition.
 ※ Test Condition - Office (49,000ft²) / Occupancy : 30 / Area : London, UK
 - ERV (1000 CMH) + MULTI V 4 (12HP) Unit Combination
 - Other conditions are subject to BREEAM

※ Comparing to if this Delay Operation function is not used.

CO₂ Level Monitoring

CO₂ sensor senses CO₂ level in the room. Users can monitor CO₂ level on new wired remote controller, and ERV controls the fan speed automatically following the level.

CO₂ Level Visualization

CO₂ sensor senses indoor CO₂ level and displays it on new wired remote controller.



Main display

If the CO₂ level is above 900ppm in the room, the red mark is on.

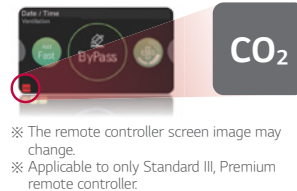

Further information

CO₂ level and room condition are displayed continuously.



CO₂ Concentration Control

Using CO₂ sensor, LG ERV controls exhaust air flow automatically to keep indoor air fresh under settled CO₂ concentration.

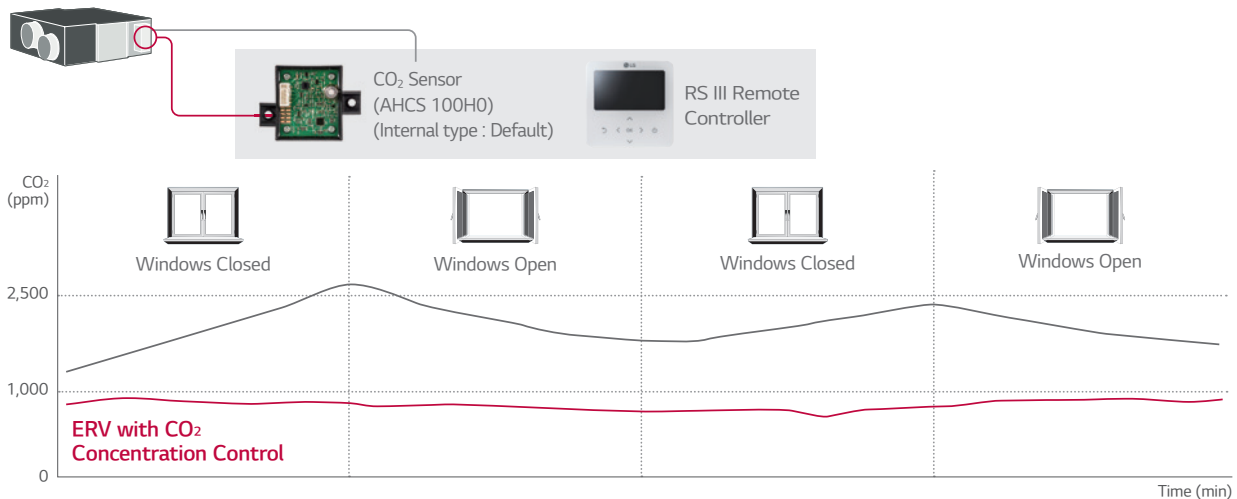

High Durability

There is no moving part within the heat exchanger and therefore it has higher durability and reliability. The heat exchanger is made of special thin paper membranes which are bacteria-resistant to prevent harmful bacteria growth, and flame-retardant treated for fire safety.

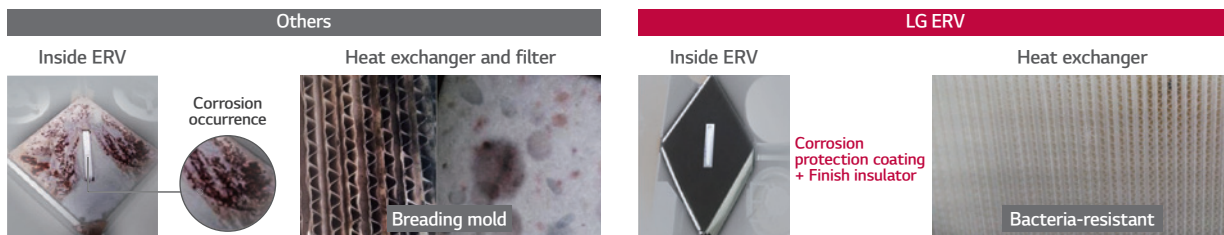

Easy Control

Wired remote controller is easy for usage.



Easy

- Navigation buttons, easy to use.
- Easy installation setting

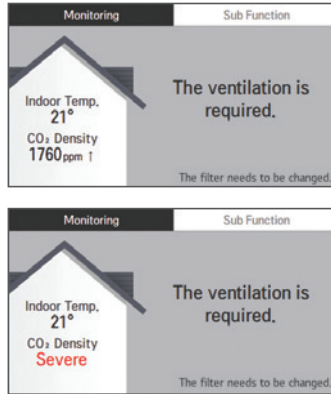

Display

- Indoor CO₂ level
- Alarm for filter change / remaining time to change filters

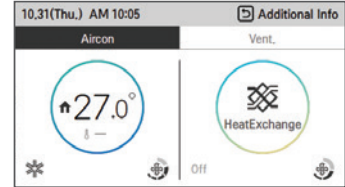

Convenient

- Flexible display
- Dual display with air conditioner
- Zoom selected directory to increase legibility

Group Control

1 wired remote controller up to 16 ERV (Including air conditioner). It is convenient for large common space such as lobby.

Several units combination

16 units group control is available with 1 remote controller.

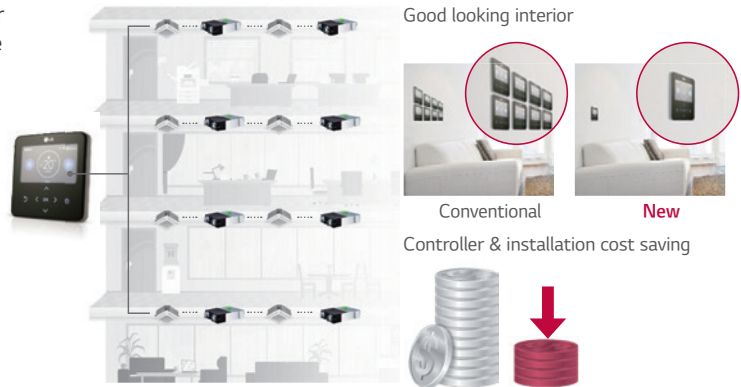

Interlocking with Air Conditioning System

- LG ERV can be interlocked with air conditioners and controlled individually.
- This function can be operated when the system is connected with 1 remote controller.

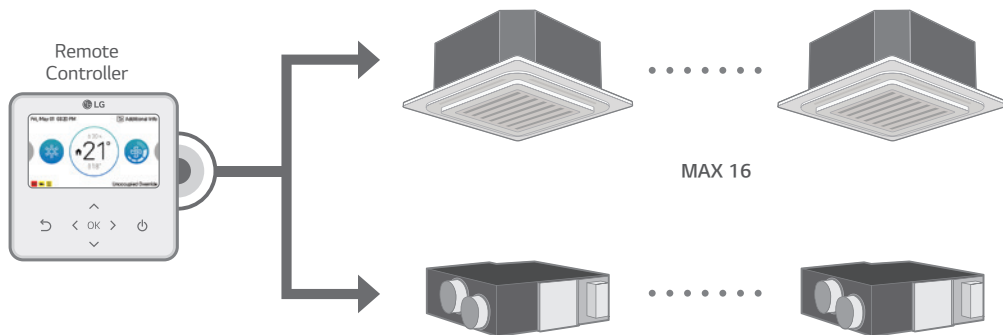

Fast Ventilation Mode

Fast ventilation mode prevents the spread of contaminants under negative indoor pressure, and makes indoor air fresh and comfortable quickly.

Only Exhausting

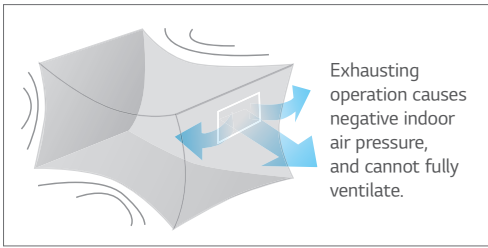

Exhausting and Supplying Simultaneously

Fast Ventilation Mode

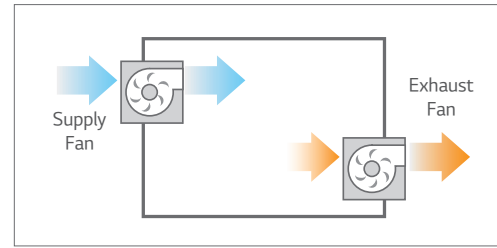

External Static Pressure Control

The high static pressure fan can control the air volume depending on the length of the duct. It is also easy to control the pressure level by using the remote controller for a more flexible duct installation and easier testing.

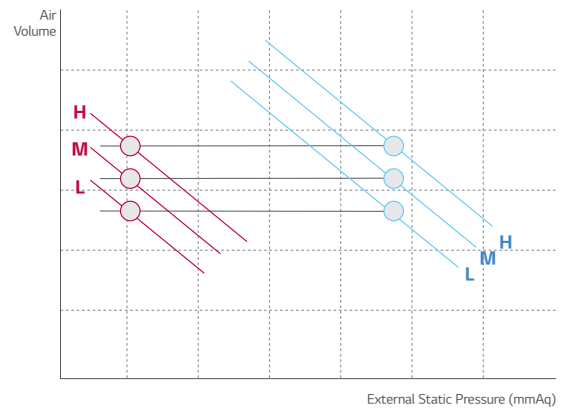

Easy Cleaning and Filter Change

Filter can be conveniently changed and cleaned.

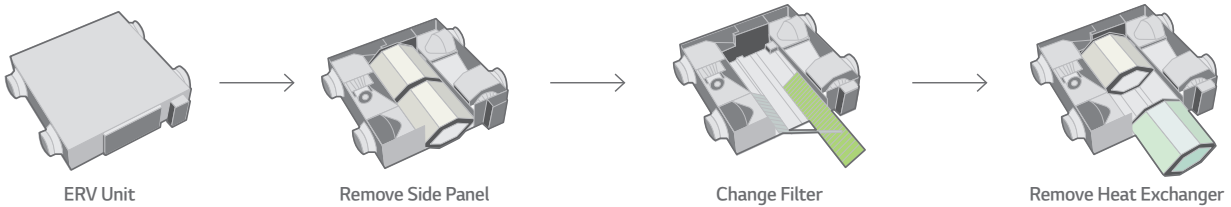

LZ-H025GBA4 / LZ-H035GBA5
LZ-H050GBA5



MODEL		UNIT	LZ-H025GBA4	LZ-H035GBA5	LZ-H050GBA5
Dimensions (W x H x D)	Body	mm	988 x 273 x 1,014		
Weight	Body	kg	44		
Power Supply		Ø, V, Hz	1, 220-240, 50		
Normal Air flow		m³/h	250	350	500
ERV Mode	Operating Step		Super-high / High / Low		
	Current	SH / H / L A	0.70 / 0.60 / 0.42	1.05 / 0.90 / 0.50	1.65 / 1.56 / 0.80
	Power Input	SH / H / L W	97 / 87 / 52	150 / 125 / 60	247 / 230 / 95
	Air Flow	SH / H / L m³/h	250 / 250 / 150	350 / 350 / 210	500 / 500 / 320
	External Static Pressure	SH / H / L Pa	100 / 70 / 50	150 / 100 / 50	150 / 100 / 50
	Temperature Exchange Efficiency	SH / H / L %	80 / 80 / 83	80 / 80 / 82	79 / 79 / 82
	Enthalpy Exchange Efficiency	Heating (SH / H / L) %	70 / 70 / 72	75 / 75 / 80	75 / 75 / 78
		Cooling (SH / H / L) %	66 / 66 / 68	71 / 71 / 75	68 / 68 / 75
	Energy Label	A+ to G Scale	A	B	B
	Sound Pressure Level	SH / H / L dB(A)	29 / 28 / 24	35 / 32 / 26	37 / 36 / 28
Sound Power Level	SH / H / L dB(A)	50	53 / 50 / 42	57 / 56 / 46	
Bypass Mode	Operating Step		Super-high / High / Low		
	Current	SH / H / L A	0.70 / 0.60 / 0.42	1.05 / 0.90 / 0.50	1.65 / 1.56 / 0.80
	Power Input	SH / H / L W	97 / 87 / 52	150 / 125 / 60	247 / 230 / 95
	Air Flow	SH / H / L m³/h	250 / 250 / 150	350 / 350 / 210	500 / 500 / 320
	External Static Pressure	SH / H / L Pa	100 / 70 / 50	150 / 100 / 50	150 / 100 / 50
	Sound Pressure Level	SH / H / L dB(A)	29 / 29 / 25	35 / 33 / 26	37 / 37 / 28
Duct Work	Qty	EA	4		
	Size (Ø)	mm	Ø200		
Supply Air Fan	Qty	EA	1		
	Type		Direct-Drive Sirocco		
Exhaust Air Fan	Qty	EA	1		
	Type		Direct-Drive Sirocco		
Filters	Qty	EA	2		
	Type		Cleanable fibrous fleeces		
	Size (W x H x D)	mm	855 x 10 x 166		

Note :

1. ERV mode : Total Heat Recovery Ventilation mode

2. Refer to dimensional drawings.

3. Noise level :

- The operating conditions are assumed to be standard
- Sound measured at : 1.5m below the center the body.

- Sound level will vary depending on a range of factors such as the construction(acoustic absorption coefficient) of particular room in which the equipment is installed.

- The sound level at the air discharge port is about 8 dB(A) higher than the unit's operating sound.

4. Temperature and Enthalpy Exchange Efficiency at cooling Indoor Temperature : 26.5°C DB, 64.5% RH, Outdoor Temperature : 34.5°C DB, 75% RH

5. Temperature and Enthalpy Exchange Efficiency at heating Indoor Temperature : 20.5°C DB, 59.5% RH, Outdoor Temperature : 5°C DB, 65% RH

6. Temperature Exchange efficiency is tested at heating condition.

Accessories

CHASSIS	LZ-H025GBA4	LZ-H035GBA5	LZ-H050GBA5
Drain Pump		-	
Cassette Cover		-	
Refrigerant Leakage Detector		-	
EEV Kit		-	
Multi-tenant Power Module		-	
Robot Cleaner		-	
Pre Filter (Washable)		-	
Ion Generator		-	
CO ₂ Sensor		○	
Ventilation Kit		-	
IR Receiver		-	
Zone Controller		-	
Dry Contact (with additional accessory)		PDRYCB000 (1 point contact), PDRYCB500 (Modbus)	
External Input (1 point)		-	
Wi-Fi		-	

※ ○ : Applied, - : Not applied

Option : Refer to model name in table

LZ-H080GBA5 / LZ-H100GBA5
LZ-H150GBA5 / LZ-H200GBA5



MODEL		UNIT	LZ-H080GBA5	LZ-H100GBA5	LZ-H150GBA5	LZ-H200GBA5
Dimensions (W x H x D)	Body	mm	1,101 x 405 x 1,230		1,353 x 815 x 1,230	
Weight	Body	kg	63		130	
Power Supply		Ø, V, Hz	1, 220-240, 50		1, 220-240, 50	
Normal Air flow		m³/h	800	1,000	1,500	2,000
ERV Mode	Operating Step		Super-high / High / Low		Super-high / High / Low	
	Current	SH / H / L A	2.13 / 1.75 / 1.00	2.92 / 2.38 / 1.40	4.26 / 3.50 / 2.00	5.92 / 4.76 / 2.80
	Power Input	SH / H / L W	328 / 266 / 144	463 / 370 / 208	660 / 530 / 290	926 / 740 / 420
	Air Flow	SH / H / L m³/h	800 / 800 / 660	1,000 / 1,000 / 800	1,500 / 1,500 / 1,200	2,000 / 2,000 / 1,600
	External Static Pressure	SH / H / L Pa	160 / 100 / 50	160 / 100 / 50	160 / 100 / 50	160 / 100 / 50
	Temperature Exchange Efficiency	SH / H / L %	82 / 82 / 83	80 / 80 / 81	82 / 82 / 83	80 / 80 / 81
	Enthalpy Exchange Efficiency	Heating (SH / H / L) %	73 / 73 / 76	71 / 71 / 73	73 / 73 / 76	71 / 71 / 73
		Cooling (SH / H / L) %	66 / 66 / 70	64 / 64 / 67	66 / 66 / 70	64 / 64 / 67
	Sound Pressure Level	SH / H / L dB(A)	40 / 36 / 32	40 / 37 / 33	43 / 39 / 35	43 / 40 / 36
Sound Power Level	SH / H / L dB(A)	56 / 53 / 47	59 / 56 / 52	59 / 56 / 50	62 / 59 / 55	
Bypass Mode	Operating Step		Super-high / High / Low		Super-high / High / Low	
	Current	SH / H / L A	2.13 / 1.75 / 1.00	2.92 / 2.38 / 1.40	4.26 / 3.50 / 2.00	5.92 / 4.76 / 2.80
	Power Input	SH / H / L W	328 / 266 / 144	463 / 370 / 208	660 / 530 / 290	926 / 740 / 420
	Air Flow	SH / H / L m³/h	800 / 800 / 660	1,000 / 1,000 / 800	1,500 / 1,500 / 1,200	2,000 / 2,000 / 1,600
	External Static Pressure	SH / H / L Pa	160 / 100 / 50	160 / 100 / 50	160 / 100 / 50	160 / 100 / 50
	Sound Pressure Level	SH / H / L dB(A)	41 / 37 / 33	41 / 38 / 34	44 / 40 / 36	44 / 41 / 37
Duct Work	Qty	EA	4		4 + 2	
	Size (Ø)	mm	Ø250		Ø250 + Ø350	
Supply Air Fan	Qty	EA	1		2	
	Type		Direct-Drive Sirocco		Direct-Drive Sirocco	
Exhaust Air Fan	Qty	EA	1		2	
	Type		Direct-Drive Sirocco		Direct-Drive Sirocco	
Filters	Qty	EA	2		4	
	Type		Cleanable fibrous fleeces		Cleanable fibrous fleeces	
	Size (W x H x D)	mm	1,148 x 6 x 245		1,148 x 6 x 245	

Note :

- ERV mode : Total Heat Recovery Ventilation mode
- Refer to dimensional drawings.
- Noise level :
 - The operating conditions are assumed to be standard
 - Sound measured at 1.5m below the center the body.
 - Sound level will vary depending on a range of factors such as the construction(acoustic absorption coefficient) of particular room in which the equipment is installed.
 - The sound level at the air discharge port is about 8 dB(A) higher than the unit's operating sound.
- Temperature and Enthalpy Exchange Efficiency at cooling Indoor Temperature : 26.5°C DB, 64.5% RH, Outdoor Temperature : 34.5°C DB, 75% RH
- Temperature and Enthalpy Exchange Efficiency at heating Indoor Temperature : 20.5°C DB, 59.5% RH, Outdoor Temperature : 5°C DB, 65% RH
- Temperature Exchange efficiency is tested at heating condition.

Accessories

CHASSIS	LZ-H080GBA5	LZ-H100GBA5	LZ-H150GBA5	LZ-H200GBA5
Drain Pump			-	-
Cassette Cover			-	-
Refrigerant Leakage Detector			-	-
EEV Kit			-	-
Multi-tenant Power Module			-	-
Robot Cleaner			-	-
Pre Filter (Washable)			-	-
Ion Generator			-	-
CO ₂ Sensor			O	-
Ventilation Kit			-	-
IR Receiver			-	-
Zone Controller			-	-
Dry Contact (with additional accessory)			PDRYCB000 (1 point contact), PDRYCB500 (Modbus)	
External Input (1 point)			-	-
Wi-Fi			-	-

※ O : Applied, - : Not applied

Option : Refer to model name in table

Providing Cool & Warm Fresh Air

During the summer, ERV DX can transform outdoor warm air into cool air for indoors, and it can prevent cold draft during the winter by supplying warm air.

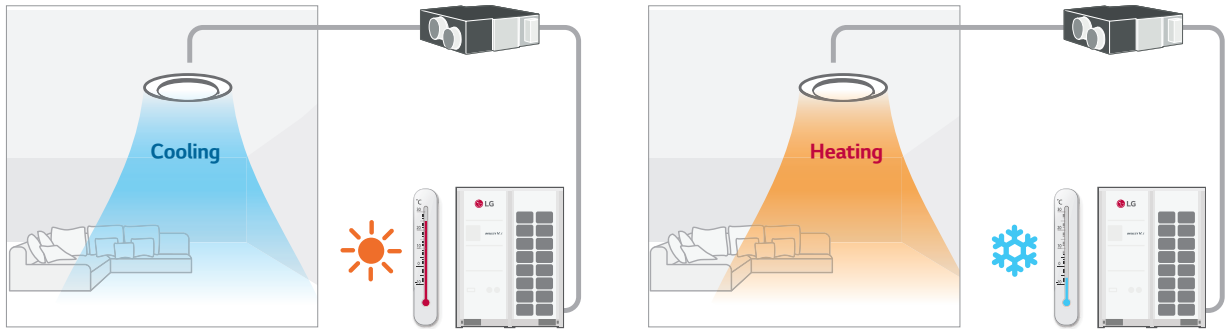

Total Air Conditioning Solution

LG ERV DX can be used as a Total Air Conditioning Solution. It can control condition of incoming air with the DX coil and humidifier for making comfortable indoor air. In the summer, LG ERV DX provides air conditioning by cooling and dehumidifying incoming air. During winter, warm air is provided by heating and humidifying incoming air.

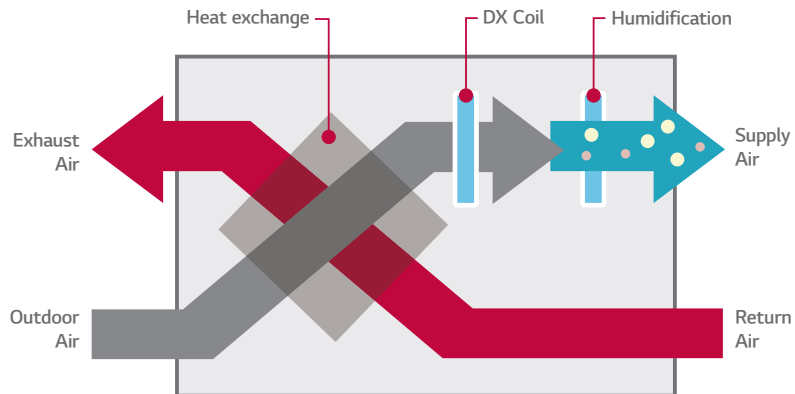

Interlocking with MULTI V

LG ERV DX can be interlocked with MULTI V. It can be controlled individually by a wired remote controller connected to MULTI V indoor units.

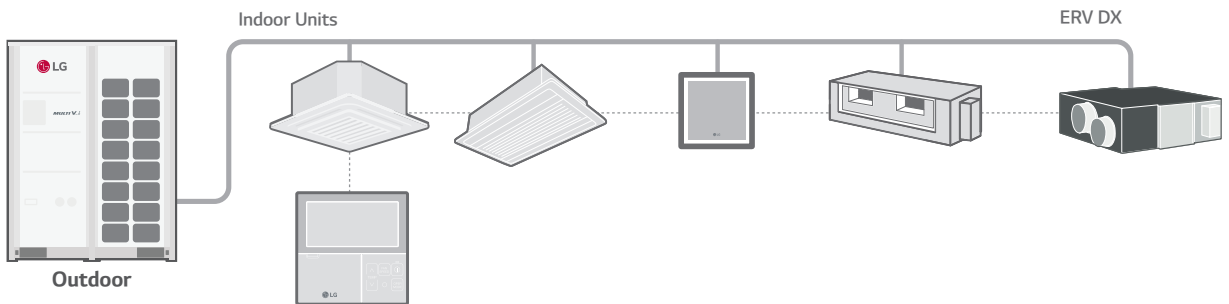

LZ-H050GXH4 / LZ-H080GXH4
LZ-H100GXH4 / LZ-H050GXN4
LZ-H080GXN4 / LZ-H100GXN4



MODEL		UNIT	LZ-H050GXH4	LZ-H080GXH4	LZ-H100GXH4	LZ-H050GXN4	LZ-H080GXN4	LZ-H100GXN4	
Fresh Air Conditioning Load	Cooling	kW	4.93	7.46	9.12	4.93	7.46	9.12	
	Heating	kW	6.73	9.80	11.72	6.73	9.80	11.72	
Temperature Exchange Efficiency	SH / H / L	%	86 / 86 / 87	80 / 80 / 81	76 / 76 / 78	86 / 86 / 87	80 / 80 / 81	76 / 76 / 78	
Enthalpy Exchange Efficiency	Cooling (SH / H / L)	%	61 / 61 / 63	50 / 50 / 53	45 / 45 / 50	61 / 61 / 63	50 / 50 / 53	45 / 45 / 50	
	Heating (SH / H / L)	%	76 / 76 / 77	67 / 67 / 69	64 / 64 / 66	76 / 76 / 77	67 / 67 / 69	64 / 64 / 66	
Operation Range	Outdoor air Temperature	°C	-15 ~ 45	-15 ~ 45	-15 ~ 45	-15 ~ 45	-15 ~ 45	-15 ~ 45	
Air Flow Rate	Heat Exchange Mode (SH / H / L)	CMH	500 / 500 / 440	800 / 800 / 640	1,000 / 1,000 / 820	500 / 500 / 440	800 / 800 / 640	1,000 / 1,000 / 820	
	Bypass Mode (SH / H / L)	CMH	500 / 500 / 440	800 / 800 / 640	1,000 / 1,000 / 820	500 / 500 / 440	800 / 800 / 640	1,000 / 1,000 / 820	
Fan	External Static Pressure (SH / H / L)	Pa	160 / 120 / 100	140 / 90 / 70	110 / 70 / 60	180 / 150 / 110	170 / 120 / 80	150 / 100 / 70	
	System		Natural Evaporating Type						
Humidifier	Amount	kg/h	2.70	4.00	5.40				
	Pressure Feed Water	Mpa	0.02 ~ 0.49						
Sound Pressure	Heat Exchange Mode (SH / H / L)	dB(A)	38 / 36 / 33	39 / 37 / 34	40 / 38 / 35	39 / 37 / 35	41 / 38 / 36	41 / 39 / 36	
	Bypass Mode (SH / H / L)	dB(A)	39 / 37 / 34	40 / 38 / 35	40 / 38 / 35	39 / 37 / 35	41 / 38 / 36	41 / 39 / 36	
Refrigerant		R410A							
Power Supply	Ø, V, Hz	1, 220-240, 50, 60							
Power Input (Nominal)	Heat Exchange Mode (SH / H / L)	kW	0.25 / 0.20 / 0.15	0.42 / 0.35 / 0.25	0.48 / 0.42 / 0.27	0.25 / 0.20 / 0.15	0.42 / 0.35 / 0.25	0.48 / 0.42 / 0.27	
	Bypass Mode (SH / H / L)	kW	0.25 / 0.20 / 0.15	0.42 / 0.35 / 0.25	0.48 / 0.42 / 0.27	0.25 / 0.20 / 0.15	0.42 / 0.35 / 0.25	0.48 / 0.42 / 0.27	
Nominal Running Current (RLA)	Heat Exchange Mode (SH / H / L)	A	1.5 / 1.3 / 1.0	2.5 / 2.0 / 1.5	3.6 / 3.2 / 2.3	1.5 / 1.3 / 1.0	2.5 / 2.0 / 1.5	3.6 / 3.2 / 2.3	
	Bypass Mode (SH / H / L)	A	1.5 / 1.3 / 1.0	2.5 / 2.0 / 1.5	3.6 / 3.2 / 2.3	1.5 / 1.3 / 1.0	2.5 / 2.0 / 1.5	3.6 / 3.2 / 2.3	
Heat Exchange System		Air to air cross flow total heat (Sensible + Latent heat) exchange				Air to air cross flow total heat (Sensible + Latent heat) exchange			
Heat Exchange Element		Specially processed non-flammable paper				Specially processed non-flammable paper			
Air Filter		Multidirectional fibrous fleeces				Multidirectional fibrous fleeces			
Dimensions	W x H x D	mm	1,667 x 365 x 1,140			1,667 x 365 x 1,140			
Net Weight		kg	105			98			
	Liquid	mm	Ø6.35			Ø6.35			
Piping Connection	Gas	mm	Ø12.7			Ø12.7			
	Water	mm	Ø6.35						
Connection Duct Diameter	Drain Pipe (Internal Dia.)	mm (inch)	Ø25 (1)			Ø25 (1)			
		mm	Ø250			Ø250			

Note :

- Cooling Capacity Test condition - Indoor temperature : 27°C DB, 19°C WB / Outdoor temperature : 35°C DB
- Heating Capacity Test condition - Indoor temperature : 20°C DB / Outdoor temperature : 7°C DB, 6°C WB
- Humidifying capacity is based on the following conditions - Indoor temperature : 20°C DB, 15°C WB / Outdoor temperature : 7°C DB, 6°C WB
- Cooling and heating capacities are based on the following conditions : Fan is based on High and Super-high.
- The operating sound measured at the point 1.5 m below the center of the unit is converted to that measured at an anechoic chamber.
- The specifications, designs and information here are subject to change without notice.

Accessories

CHASSIS	LZ-H050GXH4	LZ-H080GXH4	LZ-H100GXH4	LZ-H050GXN4	LZ-H080GXN4	LZ-H100GXN4
Drain Pump				-		
Cassette Cover				-		
Refrigerant Leakage Detector				PRLDNVSO		
EEV Kit				-		
Multi-tenant Power Module				-		
Robot Cleaner				-		
Pre Filter (Washable)				-		
Ion Generator				-		
CO ₂ Sensor				AHCS100H0		
Ventilation Kit				-		
IR Receiver				-		
Zone Controller				-		
Dry Contact (with additional accessory)				PDRYCB000 (1 point contact), PDRYCB500 (Modbus)		
External Input (1 point)				○		
Wi-Fi				-		

※ ○ : Applied, - : Not applied

Option : Refer to model name in table

Supply Clean Air

① Remove Up to 99.99% of Harmful Particles on Pre-Filter with UV nano



UV nano

UV nano is a compound word of UV (ultraviolet) LED which reduces harmful bacteria, and nanometer which is the UV wavelength unit.

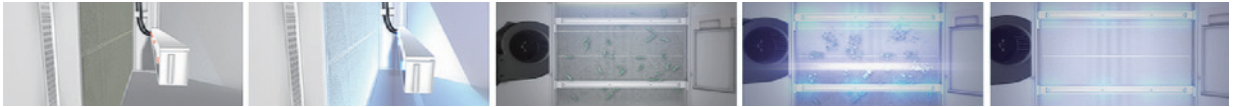

UV nano Technology Applied

It Prevents 99.99 % of Bacteria and Viruses from Growing

Easy Filter Maintenance

Via the one-touch button, the user can open the access door at the bottom of the unit, pull down the heat exchanger to change the filters. It is easy and simple without the need of any additional tools.

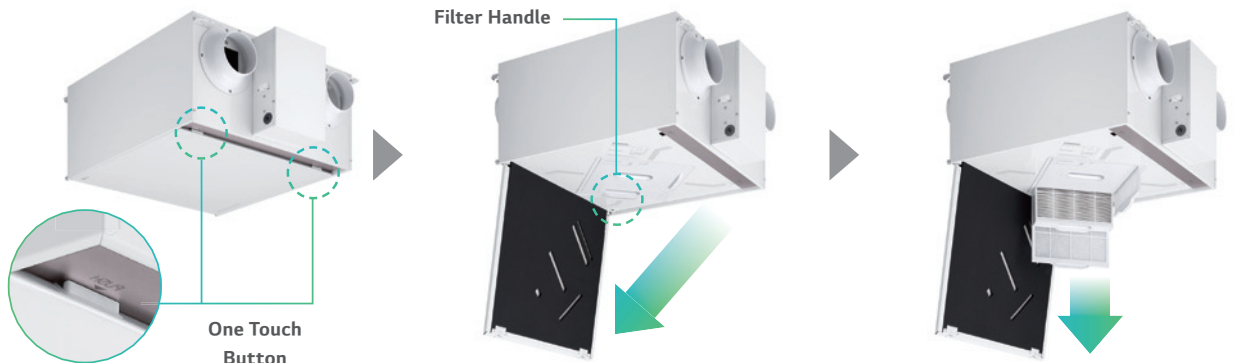

After pressing the one-touch button, unhook the safety hooks that holds door from failing to fully open the door.

Hold the filter handle and pull it out down.

Smart Control

① Dual Laser Fine Dust Sensor

Two fine dust sensors monitor the incoming air and the supplied air to the room in real time to ensure that clean air is always supplied.

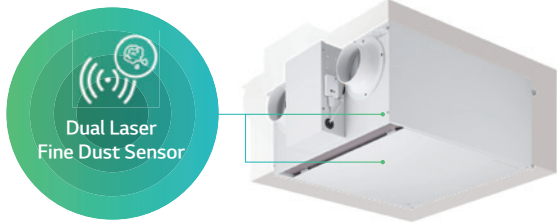

When the measured dust concentration in the air supplied to the room is higher than the pre-set value, a notification or text message will be sent out for filter replacement.

* Wi-Fi Modem is Optional.

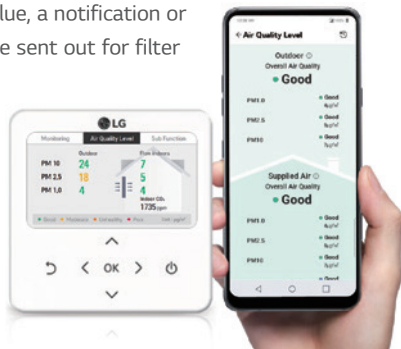

② CO₂ Monitoring

The embedded CO₂ sensor monitors the carbon dioxide concentration in the room in real time and automatically controls the ventilation rate.

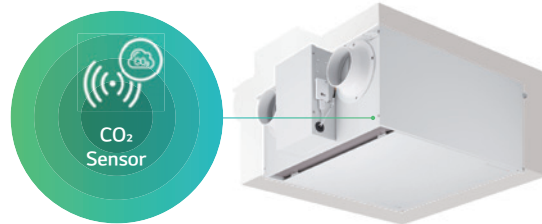



It monitor CO₂ concentration in the room. It increases the ventilation rate. when the concentration of carbon dioxide is high, and automatically reduces the ventilation rate. if it is low.

* Wi-Fi Modem is Optional.

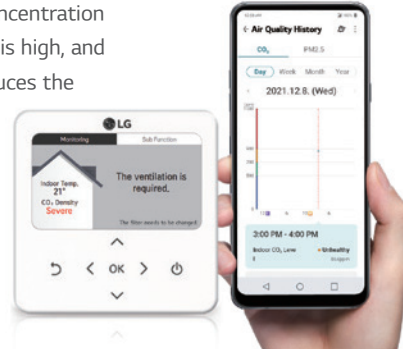
* CO₂ Sensor is Embedded.

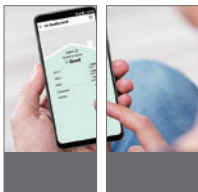

③ Control ERV Anytime, Anywhere

Wired Remote Control	Mobile	Third-Party Compatibility
		
<ul style="list-style-type: none"> - Indoor CO₂ concentration - Dust concentration in the supply air - Dust concentration in outdoor air 	<p>Check and Control the Indoor air conditioner Anytime, Anywhere</p>	<p>With the dry contact connected, Modbus protocol is available.</p>

* To use 3rd party wall pad, please contact Sales Engineer.

④ Filter Maintenance Alarm

The filter replacement notification and text message are sent when the fine dust concentration is higher than the pre-set point.

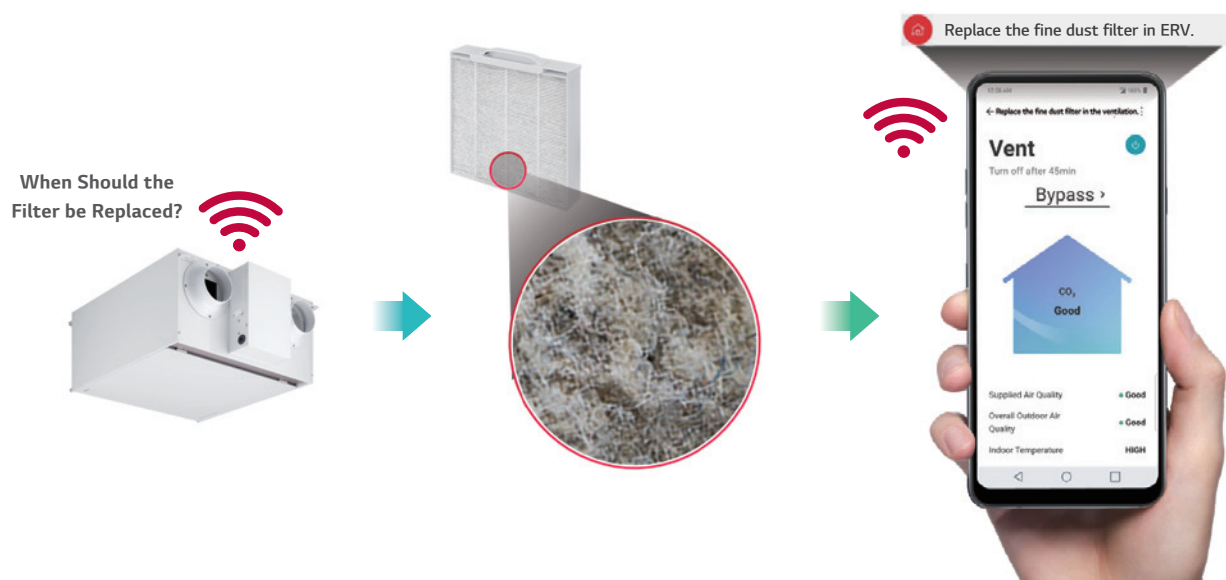

LZ-H015GBA6 / LZ-H020GBA6



MODEL		UNIT	LZ-H015GBA6	LZ-H020GBA6	
Dimensions (W x H x D)	Body	mm	640 x 320 x 640	640 x 320 x 640	
	Weight	kg	23	23	
Power Supply		Ø, V, Hz	1,230,50	1,230,50	
ERV Mode	Operating Step		SH / H / L	SH / H / L	
	Current	SH / H / L A	0.43 / 0.38 / 0.23	0.59 / 0.51 / 0.26	
	Power Input	SH / H / L W	56 / 49 / 26	79 / 71 / 30	
	Air Flow	SH / H / L CMH	150 / 150 / 80	200 / 200 / 100	
	External Static Pressure	SH / H / L Pa	100 / 70 / 50	100 / 70 / 50	
	Temperature Exchange Efficiency	Heating (SH / H / L) (ErP) %		85	82
		Heating (SH / H / L) (JIS) %		80 / 80 / 84	78 / 78 / 82
		Cooling (SH / H / L) (JIS) %		74 / 74 / 83	70 / 70 / 81
	Enthalpy Exchange Efficiency	Heating (SH / H / L) (JIS) %		79 / 79 / 83	75 / 75 / 81
		Cooling (SH / H / L) (JIS) %		74 / 74 / 80	68 / 68 / 76
	Energy Label		A+ to G Scale	A	A
	Sound Power Level	SH / H / L	dB(A)	53 / 51 / 45	55 / 53 / 46
Sound Pressure Level	SH / H / L	dB(A)	28 / 26 / 21	30 / 28 / 22	
Bypass Mode	Current	SH / H / L A	0.45 / 0.40 / 0.26	0.60 / 0.52 / 0.29	
	Power Input	SH / H / L W	63 / 53 / 31	84 / 73 / 35	
	Air Flow	SH / H / L CMH	150 / 150 / 80	200 / 200 / 100	
	External Static Pressure	SH / H / L Pa	100 / 70 / 50	100 / 70 / 50	
Operation Range	Outdoor Air Temperature / Relative Humidity	°C / %	-10 ~ 40 / 20 ~ 80	-10 ~ 40 / 20 ~ 80	
Duct Work	Qty	EA	4	4	
	Size (Ø)	mm	125	125	
Fan Motor	Supply Air Fan	RPM	1,850 / 1,710 / 1,300	2,050 / 1,910 / 1,400	
	Exhaust Air Fan	RPM	1,750 / 1,600 / 1,250	1,910 / 1,770 / 1,320	
	Max.	RPM	2,100	2100	
	Min.	RPM	1,000	1,000	
Filters	Grade ⁽¹⁾	-	ePM ₁ 95%	ePM ₁ 95%	
	Size (W x H x D)	mm	278 x 276 x 50	278 x 276 x 50	

Note :

1. Cooling Capacity Test condition - Indoor temperature : 27°C DB, 19°C WB / Outdoor temperature : 35°C DB
2. Heating Capacity Test condition - Indoor temperature : 20°C DB / Outdoor temperature : 7°C DB, 6°C WB
3. Humidifying capacity is based on the following conditions - Indoor temperature : 20°C DB, 15°C WB / Outdoor temperature : 7°C DB, 6°C WB
4. Cooling and heating capacities are based on the following conditions. : Fan is based on High and Super-high.
5. The operating sound measured at the point 1.5 m below the center of the unit is converted to that measured at an anechoic chamber.
6. The specifications, designs and information here are subject to change without notice.

Accessories

CHASSIS	LZ-H015GBA6	LZ-H020GBA6
CO ₂ Sensor		Embedded
UVnano		Embedded
Pre Filter (Washable)		Embedded
Dual Laser Fine Dust Sensor		Embedded
Remote Controller (PREMTB100 / PREMTBB10)		○
Wi-Fi Modem (PWFMD200)		○

※ ○ : Applied, - : Not applied
Option : Refer to model name in table

Functions

MODEL	LZ-H015GBA6	LZ-H020GBA6
Air Purification	UVnano	○
	Pre-Filter	○
	Fine Filter (ePM ₁ 95%)	○
Reliability	Self Diagnosis	○
Convenience	Auto Restart	○
	Child Lock*	○
	Forced Operation	○
	Group Control*	○
	Turn On / Off Reservation	○
	Schedule*	○
	Night Silent Cooling Operation	○
	Delayed Operation	○
	Airflow Amount Customized Operation	○
	Seasonal Customized Operation	○
	Seasonal Auto Operation	○
Installation	E.S.P. Control*	○
ETC	Central Control (LGAP)	○
	Filter Alarm	○
	CO ₂ Sensor	○
	Wi-Fi	Accessory

Note

- : Applied, X : Not applied
Accessory : Ordered and purchased separately the accessory package referring to the model name provided and install at field.
Accessory line-ups varies by region, so check your local catalogue or local sales material.
- Some functions can be limited by remote controller.
- * : These functions need to connect the wired remote controller

214 ~ 293

CONTROL SOLUTIONS

INDIVIDUAL CONTROL

CENTRALIZED CONTROL

INTEGRATION DEVICE





The perfect choice for innovative building management

LG BECON HVAC SOLUTION

Innovative building management solution in your hands.
Our optimized solutions provide integrated control for customers configuration of various equipment in building and intuitive interface to maximize efficiency of operations.



**ENERGY
SAVING**



**SMART
MANAGEMENT**



**EASY
EXPANDABILITY**

ENERGY SAVING



PDI



AC Smart 5



AC Manager 5



AC Ez Touch



SMART MANAGEMENT



Standard III Remote Controller



Premium Remote Controller



Wi-Fi Modem (with ThinQ)

EASY EXPANDABILITY



Modbus Gateway



ACU IO Module



Dry Contact



ACP 5

* -64, Lonworks with U60FT



ACS IO Module



CONTROL SYSTEM ARCHITECTURE

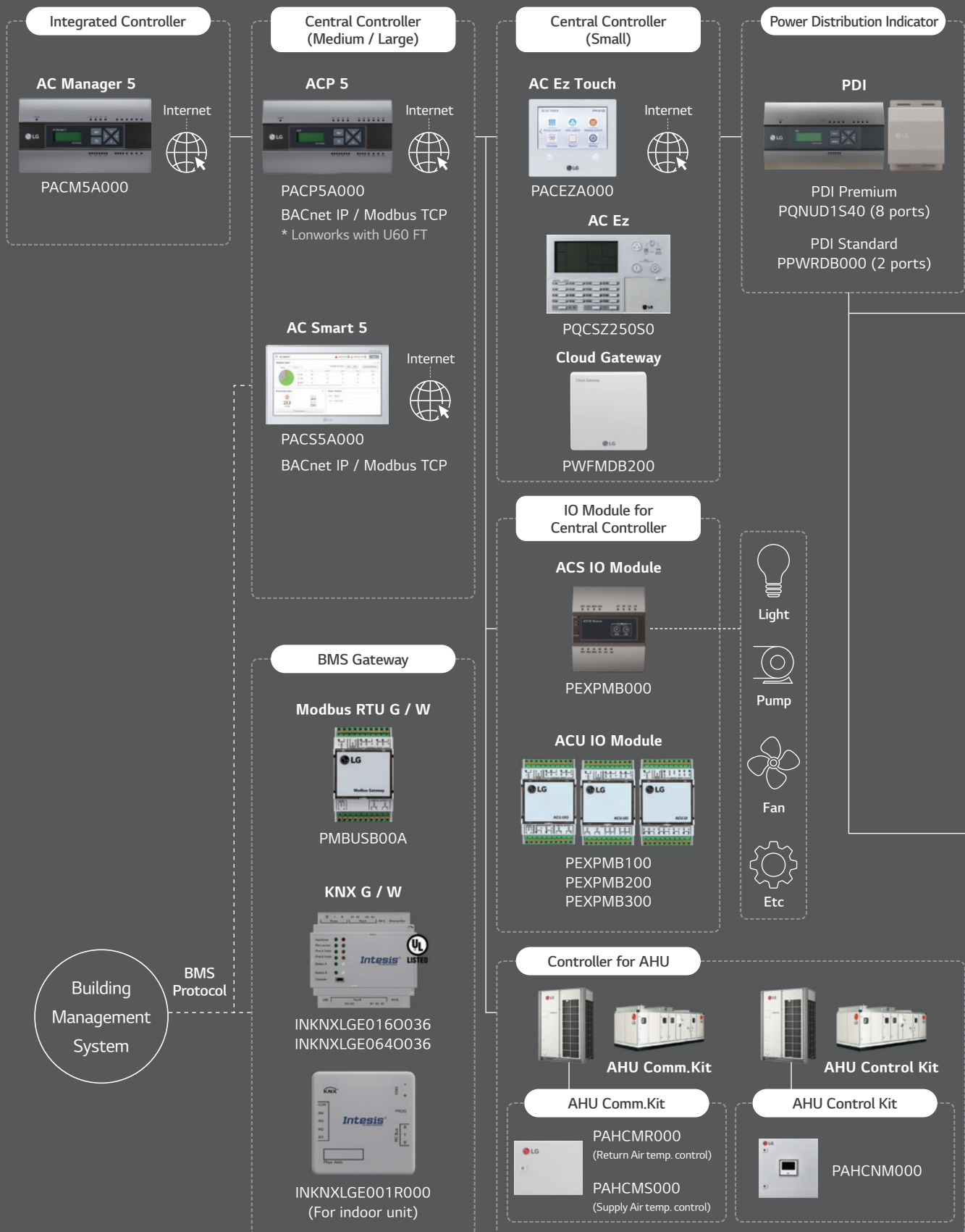



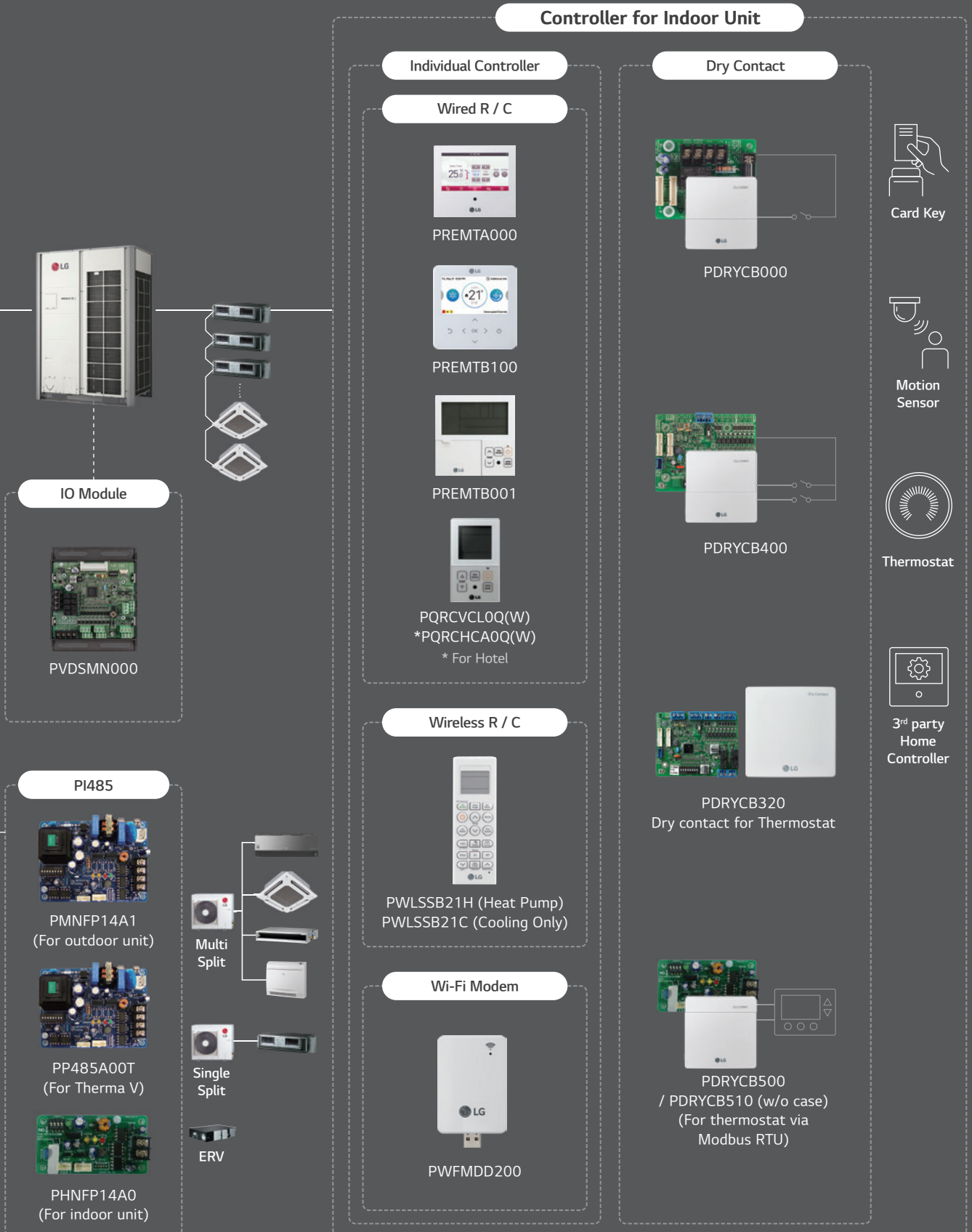

LG BECON HVAC SOLUTION offers a diverse range of effective control solutions that satisfy specific needs of each building and its user scene. These control systems are equipped with user-friendly interface, flexible interlocking environment, energy management and smart individual controller for optimized controlling conditions and smart building management.



INDIVIDUAL CONTROL



Feature Functions

Controller Name		Wired Remote Controller					Wireless Remote Controller	Wi-Fi Modem
		Premium	Standard III	Standard II	Simple	Simple (Hotel)		
Model Name								
		PREMTA000 PREMTA000A PREMTA000B	PREMTB100 PREMTBB10	PREMTB001 PREMTBB01	PQRCVCL0Q PQRCVCL0QW	PQRCHCA0Q PQRCHCA0QW	PWLSSB21H (H/P) PWLSSB21C (C/O)	PWFMDD200
Basic	On / Off	○	○	○	○	○	○	○
	Fan Speed Control	○	○	○	○	○	○	○
	Temperature Setting	○	○	○	○	○	○	○
	Mode	○	○	○	○	-	○	○
	Auto Swing	○	○	○	○	○	○	○
	Vane Control (Louver Angle)	○	○	○	○	○	○	○
	E.S.P (External Static Pressure)	○	○	○	○	○	-	-
	Electric Failure Compensation	○	○	○	○	○	-	○
	Indoor Temperature Display	○	○	○	○	○	○	○
	All Button Lock (Child Lock)	○	○	○	○	○	-	-
	Schedule / Timer	Weekly - Yearly	Weekly - Yearly	Weekly	-	-	Sleep / On / Off	Weekly
	Wi-Fi AP Mode Setting	○	○	○	○	○	○	-
Advanced	Additional Mode Setting ¹⁾	○	○	○	-	-	-	-
	Time Display	○	○	○	-	-	○	-
	Humidity Display	○	○	-	-	-	-	-
	Advanced Lock (Mode, Set point, Set point range, On / Off Lock)	Advanced Lock	Advanced Lock	-	-	-	-	-
	Filter Sign	○	○	○	-	-	-	-
	Energy Management ²⁾	○	○	○	-	-	-	-
	Dual Set Point	○	○	-	-	-	-	-
	Human Detection	-	○	-	-	-	-	-
	Temp, Humidity Compensation	○	○	-	-	-	-	-
	Air Purify Control	-	○	-	-	-	○	○
	Air Quality Level	-	○	-	-	-	-	○
	Dual Vane (6 Airflows mode)	-	○	-	-	-	○	○
ETC	Operation Status LED	○	○	○	○	○	-	-
	Wireless Remote Controller Receiver	○ ³⁾	-	○ ³⁾	○ ³⁾	○ ³⁾	-	-
	Display	5 inch Color	4.3 inch Color	4.3 inch mono	2.6 inch mono	2.6 inch mono	2 inch mono	-
	Size (W x H x D, mm)	137 x 121 x 16.5	120 x 120 x 16	120 x 121 x 16	70 x 121 x 16	70 x 121 x 16	51 x 153 x 26	48 x 68 x 14
	Black Control for Screen Saver	○	○	-	-	-	-	-

※ ○ : Applied, - : Not Applied

1) It might not be indicated or operated at the partial product.

2) Centralized control (PACEZA000 / PACSSA000 / PACPSA000 / PLNWKB000) and PDI (PQNUD1S40 / PPWRDB000) should be installed for this function.

3) For ceiling type duct

Note :

1. Indoor unit should have functions requested by the controller

2. If you need more detail, please refer to the manual of product. (<http://partnerlge.com> : Home > Doc.Library > Manual)



Design

- 4.3 inch color LCD / Intuitive GUI
- Seamless design / Touch button
- Humidity sensor embedded

Comfort & Air Purification

- CO₂ level monitoring (For ERV)
- Air quality level monitoring
- Air purify control

Energy Contents

- Power consumption monitoring
- Operation time monitoring
- Temperature setback
- Time limit control

Advanced Functions

- Comfort cooling setting
- Smart Load Control setting
- Outdoor unit low noise setting
- Defrost noise setting
- ODU capacity control
- Schedule functions



Touch Button

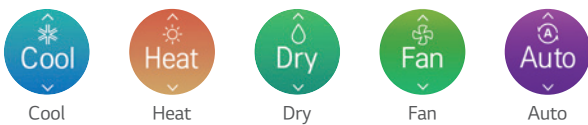

Cool

Heat

Dry

Fan

Auto

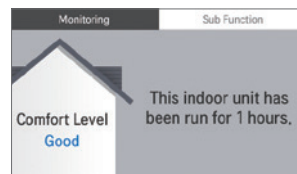

Comfort Level

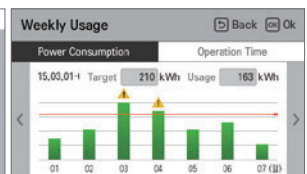

Energy Contents

Error History

06:19 21:15	>
06:19 21:15	>
06:19 14:08	>
06:19 14:04	>

Error History

Standard III Wired Remote Controller

PREMTB100 (White) / PREMTBB10 (Black)

4.3 inch colored screen with modern design.



MODEL NAME	PREMTB100 / PREMTBB10
On / Off	○
Fan Speed Control	○
Temperature Setting	○
Mode	Cool / Heat / Dry / Fan / Auto
Additional Mode Setting ¹⁾	Energy-Saving Cooling / Robot Cleaning / Heater / Humidification / Comfort Cooling
Auto Swing	○
Vane Control (Louver direction)	○
E.S.P (External Static Pressure) ²⁾	○
Reservation	Simple / Sleep / On & Off timer / Weekly / Yearly / Holiday
Time Display	○
Electric Failure Compensation	○
Lock	All / On & Off / Mode / Set temperature range
Filter Sign	○ (Remain time + Alarm)
Energy Management	Check Energy Usage ³⁾ / Check Operation Time / Target Setting (Energy, Operation Time) / Time Limit Operation / Alarm Popup / Initialization Usage Data
Operation Status LED	○
Air Purify Control ⁴⁾	○
Air Quality Level ⁴⁾	○
Indoor Temperature Display	○
Indoor Humidity Display	○
Human Detection	○
Display	4.3 inch TFT color LCD (480 x 272)
Size (W x H x D, mm)	120 x 120 x 16
Black Light for Screen Saver	○
Home Leave	2 set points control

※ ○ : Applied, - : Not Applied

1) The function is available in some product. (Refer to the product data Book).

2) This function is available for duct type.

3) This function requires PDI (PQNUD1S40 / PPWRDB000) to be installed.

4) This function is available for indoor units that provide corresponding function.

Note :

1. Indoor unit needs to have functions requested by the controller

2. 2 set points control works normally with MULTI V Heat Recovery and Single Split Heat Pump. But in case of MULTI V Heat Pump, it may not work properly.

Standard III Wired Remote Controller

Air Quality Level Display

Easy check for indoor air quality

· PM10 / PM2.5 / PM1.0 · Status / Monitoring



CLASSIFICATION	GOOD	MODERATE	UNHEALTHY	POOR
* PM10 (µg / m3)	0 ~ 54	55 ~ 154	155 ~ 254	255 ~
* PM2.5 (µg / m3)	0 ~ 12	13 ~ 35	36 ~ 55	56 ~
* PM1.0 (µg / m3)	0 ~ 12	13 ~ 35	36 ~ 55	56 ~

Note : Display color may change depending on the region / country.
This function is available for indoor units that provide corresponding function.

* PM (Particulate matter)
- PM10 : Coarse Particulate matter / PM2.5 : Fine Particulate matter / PM1.0 : Ultra Fine Particulate matter
- PM designated as a carcinogen as like an asbestos, widely known as carcinogen.
If the dust diameter is under 10 micrometers, it is PM10. And under 2.5 micrometers, it's PM2.5.

Environment Display

Displaying environment information for the more user comfort

Temperature / Humidity / Comfort level / CO₂ concentration

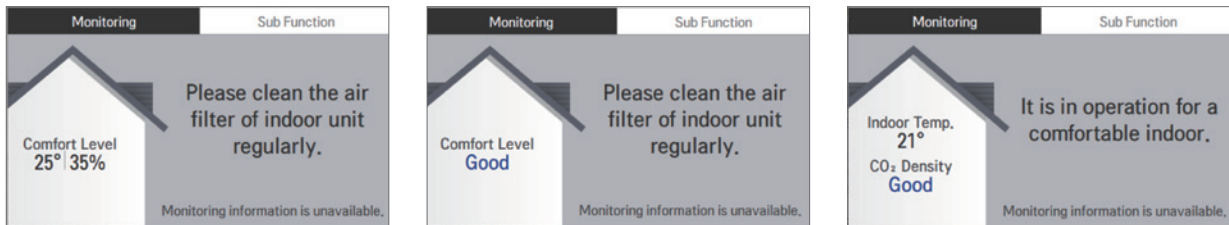

Dual Set Point

Auto changeover for convenience

- Indoor unit will keep the indoor temperature within the range of dual set point by automatically switching the unit operation.

Setback for energy savings and comfort

- In the user's absence, the room temperature will remain between two set points rather than switching off, providing quick comfort when the mode is changed to 'occupied'.

※ This function is for Heat Recovery system or Single heat pump.
Otherwise it is not guaranteed.

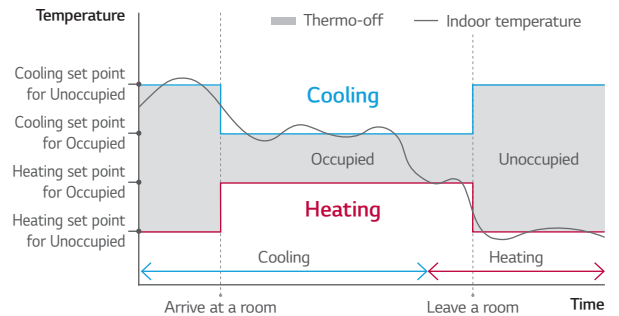

Energy Savings

Energy Management

- Energy Monitoring & Alarm

Real-time and day / week / month / year energy usage monitoring is possible. In addition, it can set target for energy usage and operation time, and alarm will be displayed when exceeded.

※ PDI (PQNUD1S40 / PPWRDB000) is required.

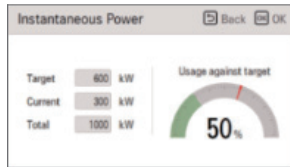

Instantaneous Power Check

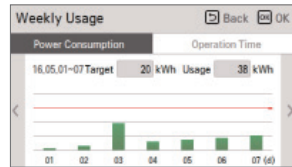

Energy Usage Target Setting

Time Limit Control

- Monitoring the unit's continuous running time.

And prevent the wasting energy by turning the unit off automatically.



Schedule Function

Simple Schedule Status

Standard III remote controller provides clock type daily schedule.

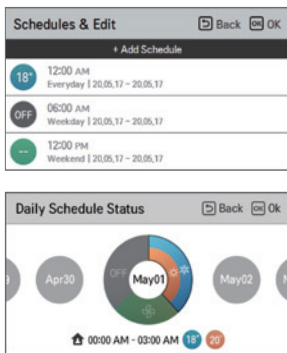

Exception Day Settings

Possible to set up exceptional date on regular schedule.

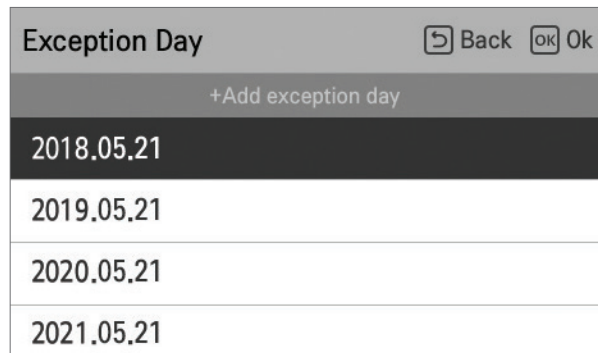

External Device On / Off

External Equipment Control

User can control the external equipment through additional contact signal output.

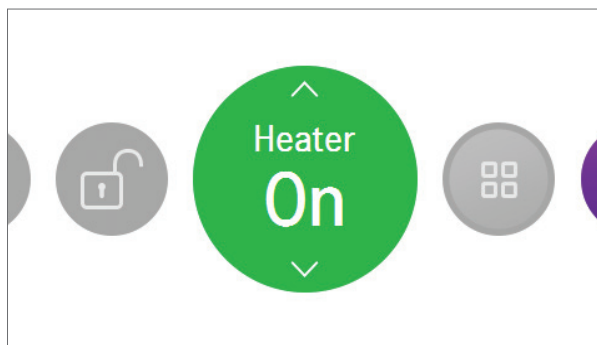

Customized Interlocking Control

User can create a automatic control pattern. For example, turning the temperature drops below or rises above a certain temperature.

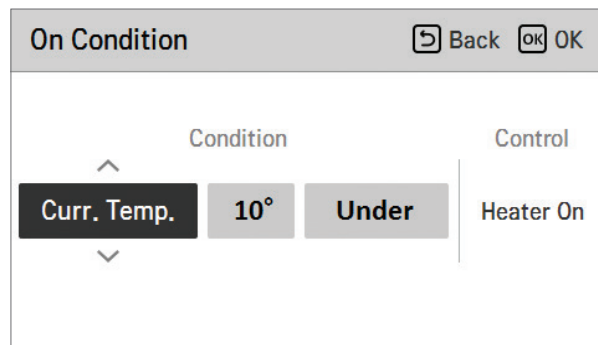

Premium Wired Remote Controller



Full Touch Screen

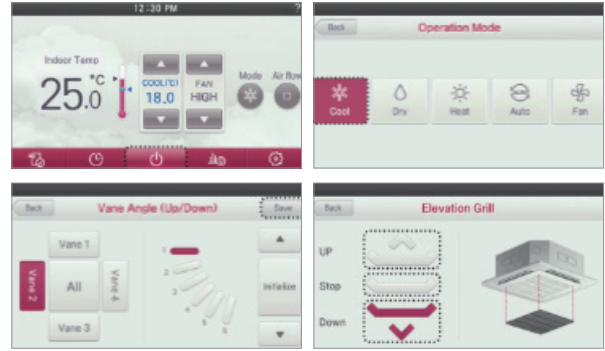

PREMTA000 ¹⁾ / PREMTA000A ²⁾ / PREMTA000B ³⁾

5 inch full touch screen with a premium design.



* Supported languages list
 1) English / Portuguese / Spanish / French
 2) English / Italian / Russian / Chinese
 3) English / German / Polish / Czech

MODEL NAME	PREMTA000 / PREMTA000A / PREMTA000B
On / Off	○
Fan Speed Control	○
Temperature Setting	○
Mode	Cool / Heat / Dry / Fan / Auto
Additional Mode Setting ¹⁾	Energy-Saving Cooling / Robot Cleaning / Heater / Humidification
Auto Swing	○
Vane Control (Louver direction)	○
E.S.P (External Static Pressure) ²⁾	○
Reservation	Simple / Sleep / On / Off / Weekly / Yearly / Holiday
Time Display	○
Electric Failure Compensation	○
Child Lock	○
Filter Sign	○ (Remain time + Alarm)
Energy Management	Check Energy Usage ³⁾ / Check Operation Time / Target Setting (Energy, Operation Time) / Time Limit Operation / Alarm Popup / Initialization Usage Data
Operation Status LED	○
Indoor Temperature Display	○
Wireless Remote Controller Receiver	○ ⁴⁾
Display	5 inch TFT color LCD (480 x 272)
Size (W x H x D, mm)	137 x 121 x 16.5
Black Light for Screen Saver	○
Home Leave	2 set points control

※ ○ : Applied, - : Not Applied

1) It might not be indicated or operated at the partial product.

2) This function is available for duct type.

3) This function requires PDI (PQNUD1S40 / PPWRDB000) to be installed.

4) For ceiling type ducted unit

Note : 1. Indoor unit needs to have functions requested by the controller

2. 2 set points control works normally with MULTI V Heat Recovery and Single Split Heat Pump. But in case of MULTI V Heat Pump, it may not work properly

Easy Energy Management

- Check the operation hour or electricity usage
- Comparison of usage by year
- Set the target usage and time



Easy Scheduling

- Daily, Weekly, Yearly schedule function
- Schedule pattern setting
- Schedule copy



Dual Set Point

- Auto changeover switching the operation mode automatically
- Setback (Leave Home) Changing status by occupied / unoccupied

* This function is only for Heat Recovery system and Single heat pump.

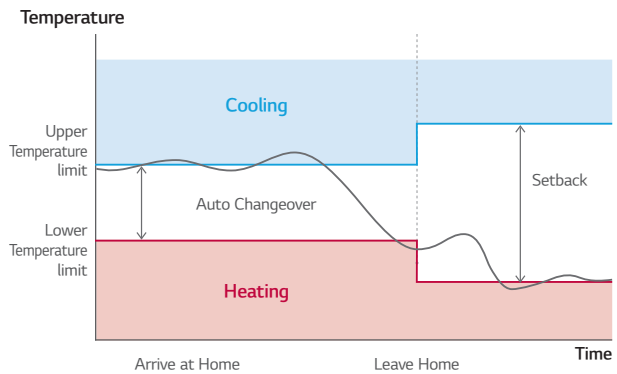

Group Control

- Max. 16 Indoor units by one remote controller

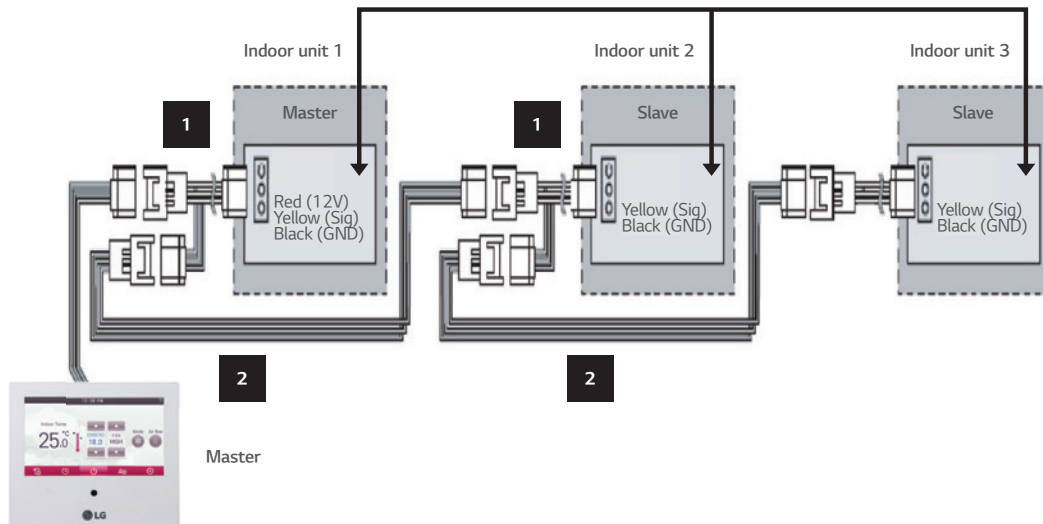

Standard II Wired Remote Controller

PREMTB001 / PREMTBB01

Providing easy control of one or a group of indoor units with various functions.



Features & Benefits

- Wired remote controller that can implement various functions such as scheduling or filter alert.

MODEL NAME	PREMTB001 / PREMTBB01
On / Off	○
Fan Speed Control	○
Temperature Setting	○
Mode	Cool / Heat / Dry / Fan / Auto
Additional Mode Setting	Energy-Saving Cooling / Robot Cleaning / Heater / Humidification
Auto Swing	○
Vane Control (Louver direction)	○
E.S.P (External Static Pressure)	○
Reservation	Simple / Sleep / On / Off / Weekly / Holiday
Time Display	○
Electric Failure Compensation	○
Child Lock	○
Filter Sign	○ (Remain time + Alarm)
Operation Status LED	○
Indoor Temperature Display	○
Wireless Remote Controller Receiver	○ ¹⁾
Size (W x H x D, mm)	120 x 121 x 16
Black Light	○
Power Consumption Monitoring	○ ²⁾
Check Model Information	○

※ ○ : Applied, - : Not Applied

1) For ceiling type ducted unit

2) This function requires PDI (PQNUD1S40 / PPWRDB000) to be installed.

Note : Indoor unit needs to have functions requested by the controller.

Simple Wired Remote Controller

PQRCVCL0QW (White) / PQRCVCL0Q (Black) / PQRCHCA0QW (White) / PQRCHCA0Q (Black)

A simple way to control office or hotel systems in a compact design.



Features & Benefits

- Small remote control with minimal functionality.

MODEL NAME	PQRCVCL0QW / PQRCVCL0Q	PQRCHCA0QW / PQRCHCA0Q
On / Off	○	○
Fan Speed Control	○	○
Temperature Setting	○	○
Mode	Cool / Heat / Dry / Fan / Auto	-
Auto Swing	○	○
Vane Control (Louver direction)	○	○
E.S.P (External Static Pressure)	○	○
Electric Failure Compensation	○	○
Child Lock	○	○
Indoor Temperature Display	○	○
Wireless Remote Controller Receiver	○ ¹⁾	○ ¹⁾
Size (W x H x D, mm)	70 x 121 x 16	70 x 121 x 16
Black Light	○	○

※ ○ : Applied, - : Not Applied

1) For ceiling type ducted unit

Note : Indoor unit needs to have functions requested by the controller.

Wireless Remote Controller

PWLSSB21H (Heat Pump), PWLSSB21C (Cooling Only)

Handy and portable wireless type.



Features & Benefits

- Easy to use while moving.
- Main functions are available.

MODEL NAME	PWLSSB21H (H/P), PWLSSB21C (C/O)
On / Off	○
Fan Speed Control	○ ¹⁾
Temperature Setting	○
Mode	Cool / Heat / Dry / Fan / Auto
Additional Mode Setting	Air Purification / Energy-Saving Cooling / Rbot Cleaning / Auto Dry
Auto Swing	○
Vane Control (Louver direction)	○
Reservation	Sleep / On / Off
Time Display	○
Indoor Temperature Display	○
Sleep Mode Auto	Max. 7 hours
Size (W x H x D, mm)	51 x 153 x 26

※ ○ : Applied, - : Not Applied

1) For some products, you can use "slow" fan speed function.

Wi-Fi Modem

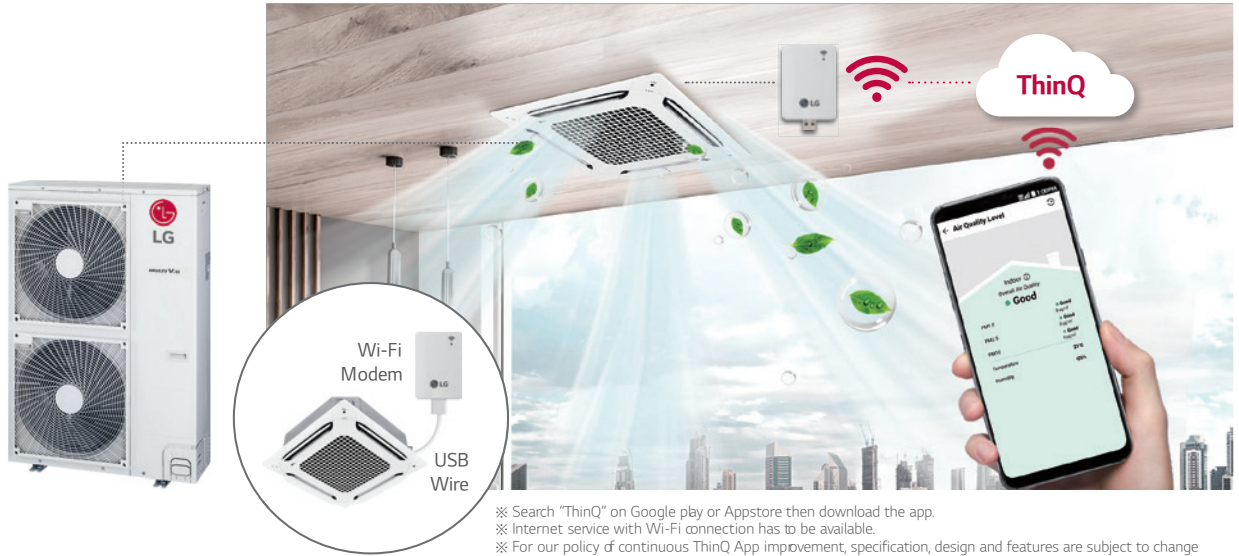

※ Search "ThinQ" on Google play or Appstore then download the app.
 ※ Internet service with Wi-Fi connection has to be available.
 ※ For our policy of continuous ThinQ App improvement, specification, design and features are subject to change without prior notice.

PWFMDD200

Control conditioners by using internet devices as Android or iOS smartphones.



Features & Benefits

- User can enjoy anytime, anywhere access with Wi-Fi equipped device through LG's ThinQ mobile app.
 - This allows the user to access the unit remotely to switch unit on or off before or after leaving the vicinity.
 - LG's exclusive Home Appliances control app (ThinQ) is available.
 - Simple operation for various functions.
- | | |
|----------------------------------------------------------------------------------------------------------------------------------------------------------------------------------------|-----------------------------------------------------------------------------------------------------------------------------------------------------------------------------------------------------------------------------|
| <ul style="list-style-type: none"> - On / Off - Operation Mode - Current / Set Temperature - Fan Speed - Vane Control ¹⁾ | <ul style="list-style-type: none"> - Reservation (Sleep, Weekly On / Off) - Energy Monitoring ²⁾ - Filter Management - Error Check - Air Purify ³⁾ |
|----------------------------------------------------------------------------------------------------------------------------------------------------------------------------------------|-----------------------------------------------------------------------------------------------------------------------------------------------------------------------------------------------------------------------------|

MODEL NAME	PWFMDD200
Size (W x H x D, mm)	48 x 68 x 14
Interfaceable Products	System Air Conditioner ³⁾
Connection Type	Indoor unit 1:1
Communication Frequency	2.4 GHz
Wireless Standards	IEEE 802.11b / g / n
Mobile Application	ThinQ (Android v4.1(Jellybean) or higher) iPhone iOS 9.0 or higher)
Optional Extension Cable	PWYREW000 (10m extension)

1) Vane Control may not be possible according to the type of Indoor unit.
 2) LG Centralized controller and PDI installation is required for this function.
 3) For the compatibility with Indoor unit, please contact regional LG office.
 Note :
 1. Functionality may be different according to each IDU model.
 2. User interface of application shall be revised for its design and contents improvement.
 3. Application is optimized for smartphone use, so it may not be well functioning with tablet devices.

Installation Scene

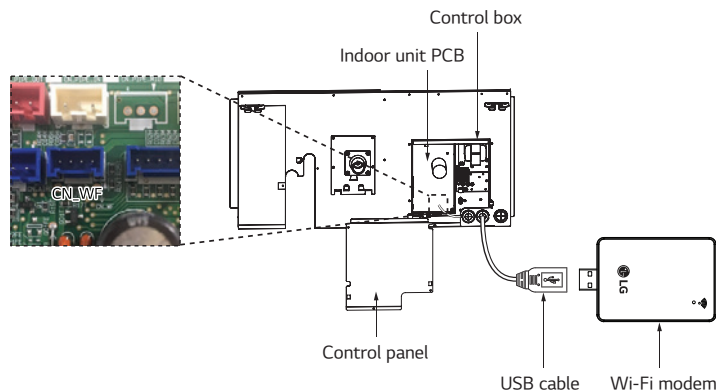

※ The Wi-Fi communication distance and reliability may vary due to the type of Wi-Fi router and the installation environment, Please refer to the manual.

ThinQ Connectivity

Connection (Pairing) Order

- 1 Make LG account on ThinQ (Application) and login.
- 2 Select the installed product and set AP (Access Point) mode by wired / wireless remote controller.
- 3 Select the Wi-Fi network that will be used and insert the passwords.
- 4 Product registration progress is completed.

* 5GHz networks may not be supported.

4 ThinQ

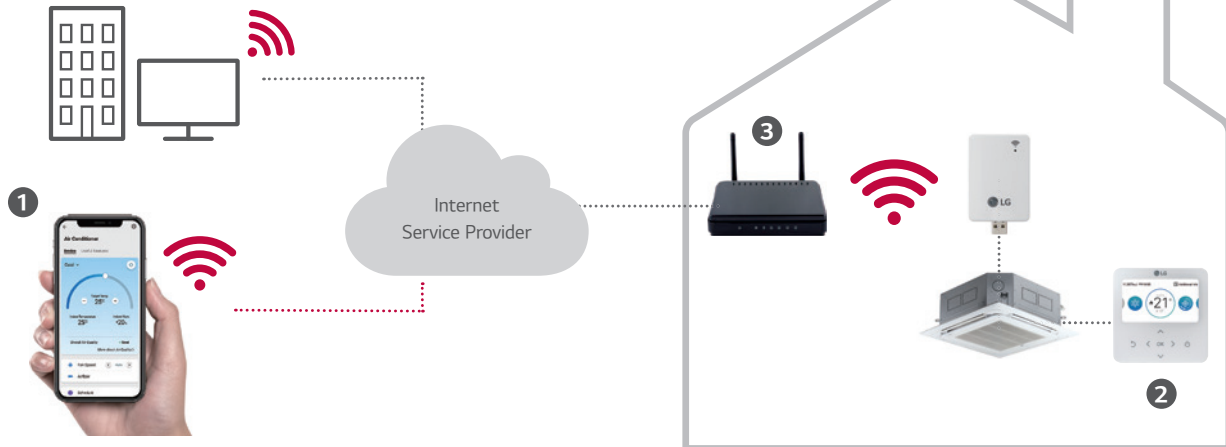

ThinQ Mobile App

Simple operation for various functions

On, Off, Current Temp., Mode, Set Temp.

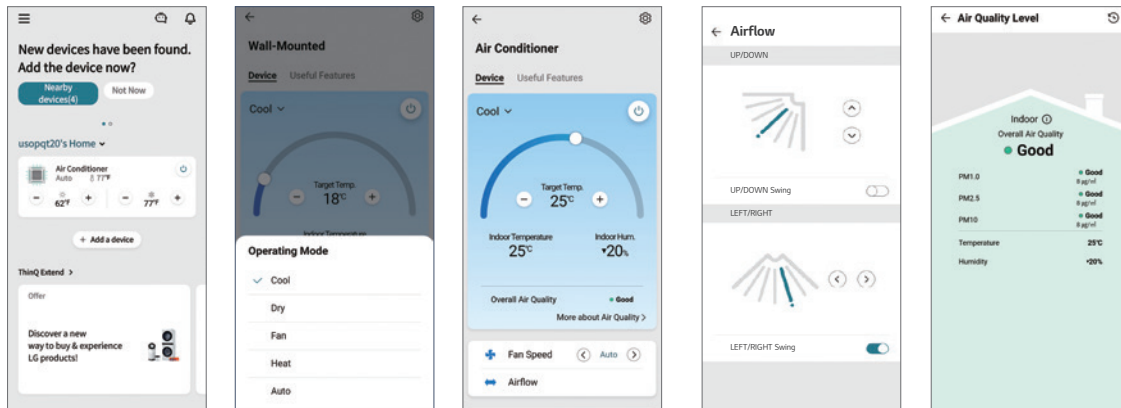

Easy Management

Reservation

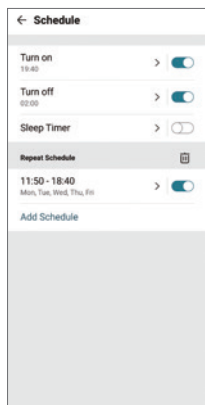

Energy Monitoring

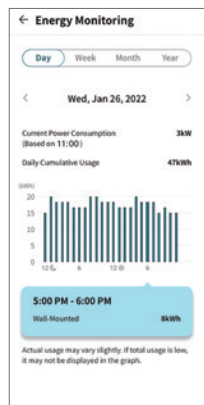

Smart Diagnosis





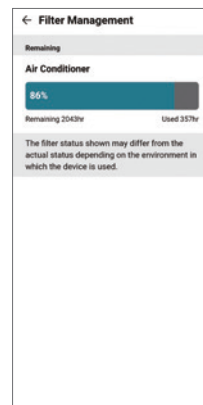



Filter Management



※ For our policy of continuous ThinQ App improvement, specification, design and features are subject to change without prior notice.



Feature Functions

Controller Name		AC Ez	AC Ez Touch	AC Smart 5 ⁶⁾	ACP 5 ⁶⁾	AC Manager 5 ⁷⁾	Cloud Gateway		
Model Name									
		PQCSZ250S0	PACEZA000	PACSS5A000	PACP5A000	Using Lonworks	PACM5A000	PWFMD200	
Product	DO	-	-	2	4	2	-	-	
	DI	-	1	2	10	2	-	-	
	Max. Connectable No.	IDUs	32	64	128	256	64	8,192	16
		ERV	32	64	128	256	64	8,192	16
		A / C + ERV	32	64	128	256	64	8,192	16
		AHU	-	-	16	16	16 ⁵⁾	16 x 32	-
Chiller		-	-	5	10	-	10 x 32	-	
Commercial Air Purifier ¹⁾	-	-	64	128	-	128 x 32	-		
Compatibility	Air Conditioner	○ ³⁾	○	○	○	○	○	○	
	Ventilation (ERV / ERV DX)	○ ⁴⁾	○	○	○	○	○	○	
	Heating	-	○	○	○	○	○	○ ⁸⁾	
	AHU	-	-	○	○	○	○	-	
	Chiller	-	-	○ ⁵⁾	○ ⁵⁾	-	○	-	
	Commercial Air Purifier ¹⁾	-	-	○ ⁵⁾	○ ⁵⁾	-	○	-	
	ACS IO	-	-	○	○	○ ⁵⁾	○	-	
Additional Function	Add Drawing	-	-	○ ⁵⁾	○ ⁵⁾	○ ⁵⁾	○	-	
	Group Management	-	○	○ ⁵⁾	○ ⁵⁾	○ ⁵⁾	○	-	
	Auto Changer Over	-	○	○ ⁵⁾	○ ⁵⁾	○ ⁵⁾	○	-	
	Set Back	-	○	○ ⁵⁾	○ ⁵⁾	○ ⁵⁾	○	-	
	Dual Setpoint	-	○	○	○	○ ⁵⁾	○	-	
	Change Alarm	-	Filter	Filter	Filter	Filter	Filter	-	
	Indoor Unit Lock	○ ²⁾	○	○	○	○ ⁵⁾	-	-	
	Cycle Monitoring	-	-	○	○	○ ⁵⁾	○	○	
	Air Purify	-	○ ⁵⁾	○ ⁵⁾	○ ⁵⁾	-	○	-	
Schedule	○	○	○ ⁵⁾	○ ⁵⁾	○ ⁵⁾	○	○ ⁹⁾		
Auto Control	Peak Control	Energy & Priority Control	-	○	○	○	○ ⁵⁾	○	-
		Outdoor Unit Capacity Control	-	-	○ ⁵⁾	○ ⁵⁾	○ ⁵⁾	○	-
	Time limit control	-	-	○ ⁵⁾	○ ⁵⁾	○ ⁵⁾	○	-	
	Interlocking	-	-	○ ⁵⁾	○ ⁵⁾	○ ⁵⁾	○	-	
Energy Navigation	-	-	○ ⁵⁾	○ ⁵⁾	-	○	-		
Energy Report	Power	-	○	○	○	○ ⁵⁾	○	○ ⁸⁾	
	Gas	-	-	○	○	○ ⁵⁾	○	-	
	Run time	-	-	○ ⁵⁾	○ ⁵⁾	○ ⁵⁾	○	-	
	Save to PC / USB (Excel)	-	-	PC / USB ⁵⁾	PC	PC	PC	-	
Trend Reporting	-	-	○ ⁵⁾	○ ⁵⁾	-	○	-		
History	Report (Control / Error)	-	Error	○ ⁵⁾	○ ⁵⁾	○ ⁵⁾	○	○	
	Send Email	-	-	○ ⁵⁾	○ ⁵⁾	○ ⁵⁾	○	-	
	Save to PC / USB (Excel)	-	-	PC / USB	PC	○ ⁵⁾	PC	-	
etc	Summer Time	-	○	○ ⁵⁾	○ ⁵⁾	○ ⁵⁾	○	-	
	Outdoor Unit Oil-Return Operation	-	-	○ ⁵⁾	○ ⁵⁾	○ ⁵⁾	-	-	
	User Authority	-	Password	○ ⁵⁾	○ ⁵⁾	○ ⁵⁾	○	-	
	PC Access	-	○	○ ⁵⁾	○ ⁵⁾	○ ⁵⁾	○	-	

※ ○ : Applied, - : Not Applied
 1) The Commercial Air purifier must additionally install PI485 (PHNFP14A0).
 2) Hard Lock
 3) Except for some feature (Individual lock, Limit temp., etc.)
 4) Except for some feature (User mode, additional function, etc.)
 5) This function is not applied for BMS points.
 6) Without additional device, ACP 5 and AC Smart 5 provide BACnet IP and Modbus TCP interface for BMS.
 7) ACP 5 or AC Smart 5 is required.
 8) Only for Therna V
 9) It will be released until 1Q in 2023.

AC Ez Touch

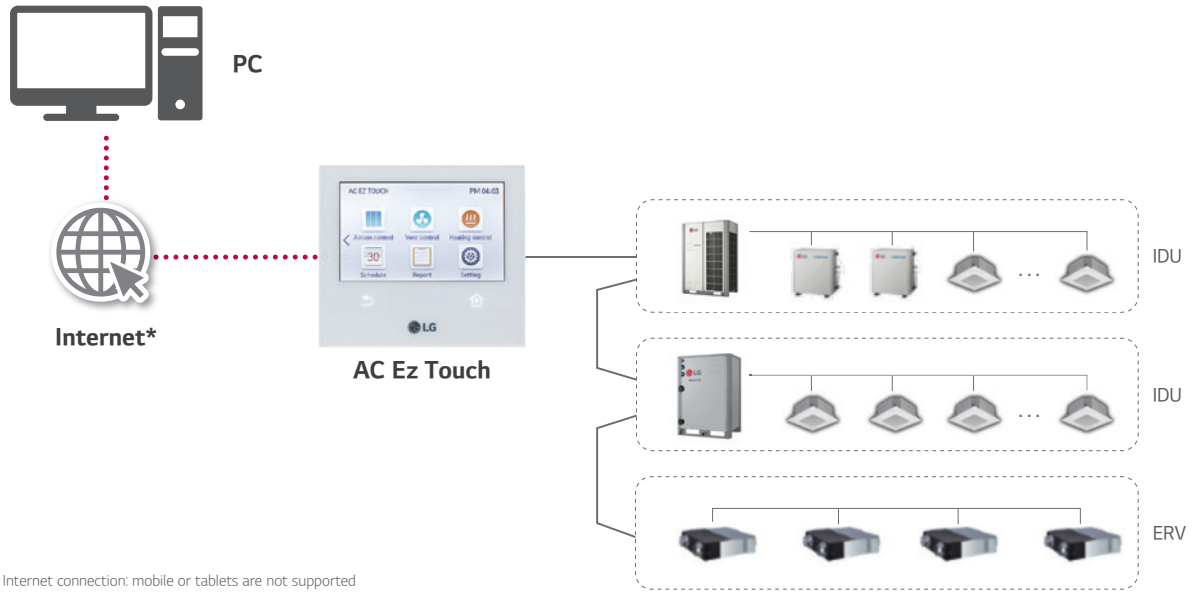

* Internet connection: mobile or tablets are not supported
 * Appropriate PI485 should be used according to PDB.

PACEZA000

Smart management with 5 inch touch screen for small site.



MODEL NAME	PACEZA000
Size (W x H x D, mm)	137 x 121 x 25
Interfaceable Products	MULTI V / ERV / ERV DX / Hydro Kit / THERMA V
Maximum number of units	64
Individual / Group Control	On & Off / Mode / Temperature / Fan speed
Individual Controller Lock	Temperature / Mode / Fan speed / All
Error Check	○
Slave Mode (Interlocking with higher level controller)	○
Schedule	Weekly / Monthly / Yearly / Exception day
Remote Access	By client SW (Neither Andoid nor IOS are supported)
Emergency Stop & Alarm Display	○
Power Consumption Monitoring (with PDI)	○
Auto Changeover / Setback	○
Temperature Limit	○
Operation History	Error record
ODU Low Noise ¹⁾	○
Daylight Saving Time	○
External IO Port	DI 1
IPv6 Support	○
Air Purify Control	○
Air Quality Level	○

※ ○ : Applied, - : Not Applied
 1) It is only available in some products.

PC Access

Users can control each space efficiently through PC access.

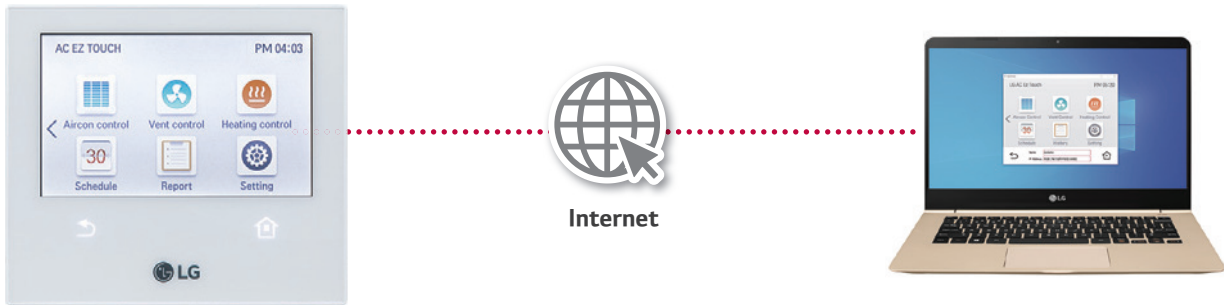

* IPv6 supported
 - Open port 80 & 9300
 - Fix public IP is mandatory. Router configuration of NAT is required.

Energy Statistics (with PDI)

Statistics of operational status (Time, Power consumption) are provided to help make intelligent system operation decisions.

Energy		
2020.2.8 ~ 2020.3.19		
Today Week Month		
Name	Usage(kWh)	Accumulated(kWh)
Group1	110	3021
Group2	150	6186
Group3	130	4267
Group4	120	7614

Energy Mode

When using energy mode function, operation Modes from cooling to fan or heating to off mode by force. (It is available only for operating indoor unit)

The screenshot shows the 'Aircon Control' interface. It displays a grid of units with their current modes and temperatures. A green 'e' icon is overlaid on the interface, indicating the Energy Mode function. The units shown include Group (0) with 1 unit, Group (1) with 2 units, and individual units AC_03 through AC_0E. Modes range from FAN, HEAT, AUTO, and DRY.

Air Purify Control & Monitoring

The screenshot shows the 'AC_UNIT_00' control window. It displays the room temperature as 23.0° and indicates that the unit is 'Now working'. The UVnano feature is turned ON. Below this, the 'Air Purification' status is shown as ON, and the 'Overall Air Quality' is monitored with PM10, PM2.5, and PM1.0 levels.

The screenshot shows the 'Aircon control(1unit)' dialog box. It allows for setting the temperature to 23.0° and includes options for 'Air Clean' (ON), 'Swing' (OFF), and 'UVnano' (ON). There are also controls for 'Set temp range' (16.0°~30.0°) and '2set point' (OFF).

AC Ez Touch

Alarm Indicator

It shows errors and alarm information. Users can respond immediately according to alarm indicator therefore HVAC system is monitored consistently.

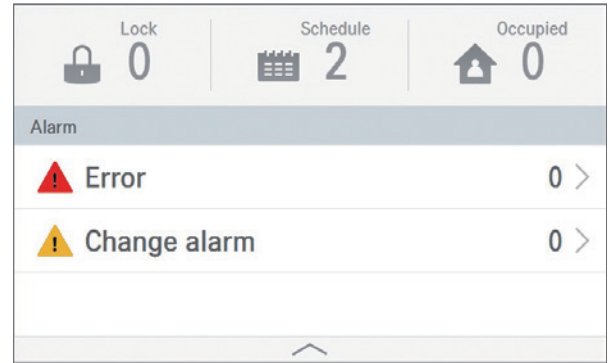

Schedule

Schedule control allows user to set the events in advance to maximize system performance. Also, by blocking unnecessary operation, it prevents a waste of energy.

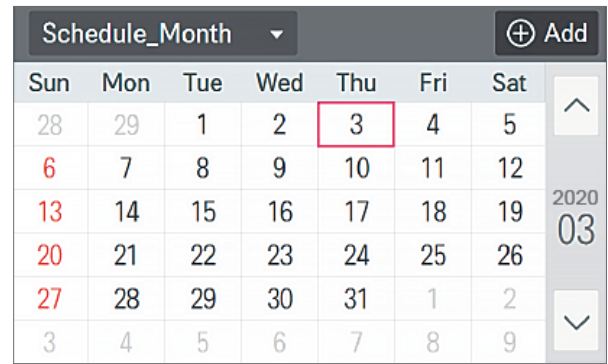

Group / Individual Control

User can control each indoor unit individually or by group by simply clicking each unit on control screen.

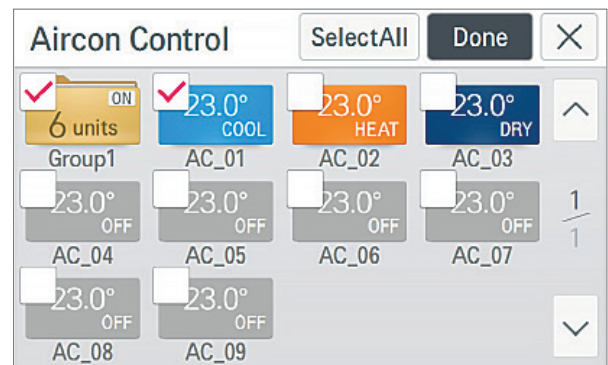

AC Ez

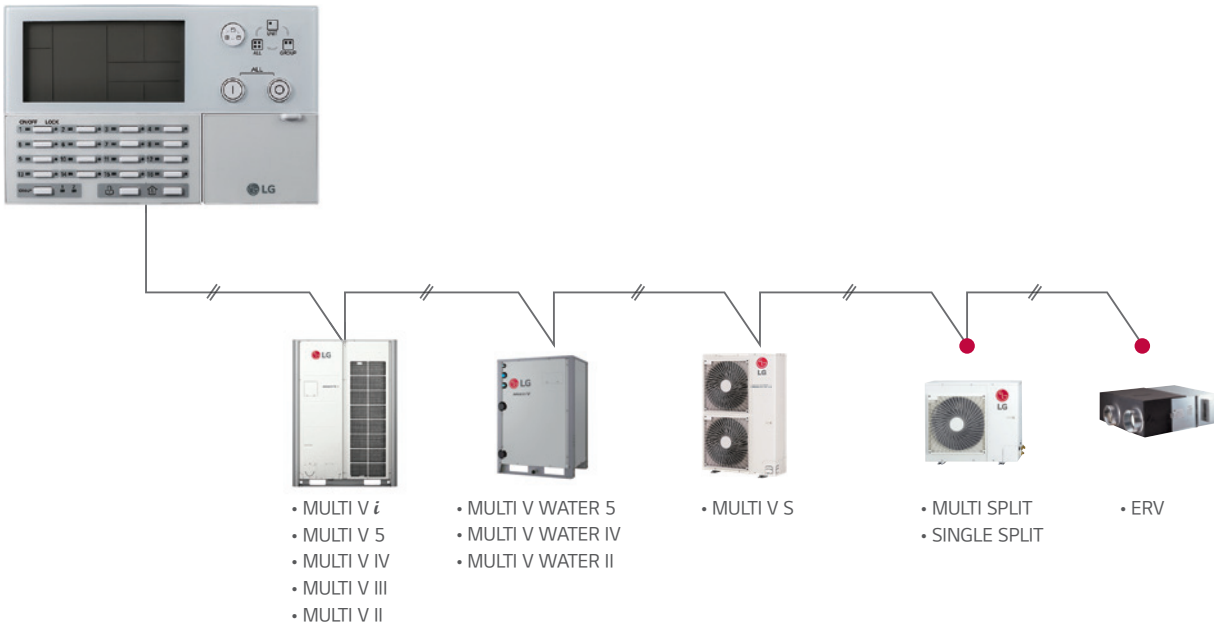

• Appropriate PI485 should be used according to PDB.

PQCSZ250S0

Easy to manage up to 32 indoor units, including ERV with simple interface.



Features & Benefits

- 32 indoor units control
- Weekly Schedule
- Individual / Group Control

MODEL NAME	PQCSZ250S0
Size (W x H x D, mm)	190 x 120 x 20
Interfaceable Products	MULTI V / ERV / ERV DX
Display	LED / LCD Display
Power	DC12V, 1A
Maximum number of units	32
Individual / Group Control	On & Off / Mode / Temperature / Fan speed
Individual Controller Lock	All
Error Check	○
Slave Mode (Interlocking with higher level controller)	○
Schedule	Weekly

※ ○ : Applied, - : Not Applied

Cloud Gateway

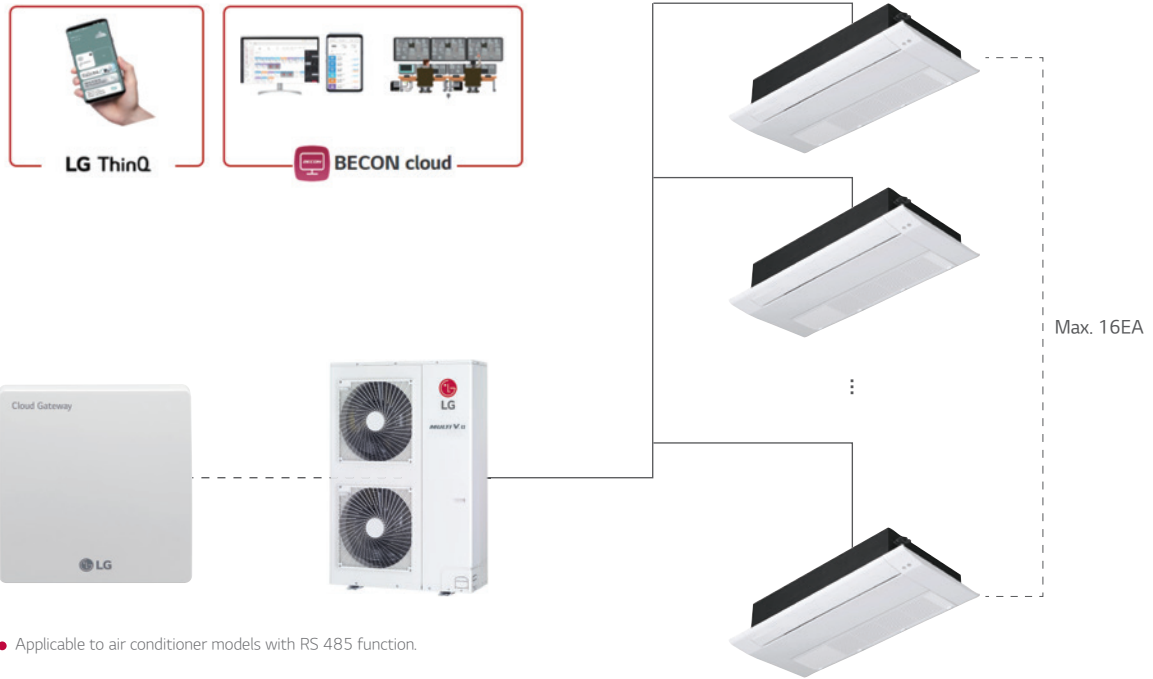

PWFMDB200

Cloud Gateway can remotely control up to 16 indoor units through LG ThinQ or BECON Cloud.

NEW

Cloud Gateway

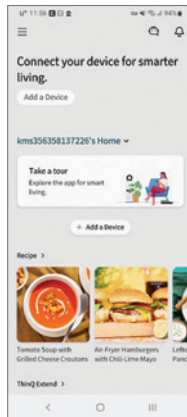

MODEL NAME	PWFMDB200
Size (W x H x D, mm)	120 x 120 x 29
Interfaceable Products	System Air Conditioner
Maximum Number of Units	16
Communication Frequency	2.4 GHz
Wireless Standards	IEEE 802.11b/g/n
Mobile Application	LG ThinQ (Android 8.0 ↑, iOS 13.0 ↑)

Function		ThinQ	BECON Cloud ¹⁾
Max. number of unit		16	
Remote Control	Operation Start / Stop	○	○
	Operation Mode	○	○
	Target Temperature	○	○
	Fan speed	○	○
	Swing	○	○
	Air Purify	○	○
Interlocking Product	MULTI V	○ ²⁾	○
	GHP	○	○
	MULTI	○	○
	Single	○	○
	ERV	X	○
	Heating	X	○ ³⁾
Etc	Schedule	○	△ ⁴⁾
	Electricity Monitoring	X	○ ³⁾
	History	X	○
Maintenance	Smart Diagnosis	○	X
	Cycle Monitoring	X	○

1) Depending on the region, BECON Cloud may not be available. Please contact to BECON Cloud administrator for checking availability. (BECONcloud-biz@lge.com)

2) Hydrokits are excluded

3) Only for Therma V

4) It will be released until 1Q in 2023.

CENTRALIZED CONTROL

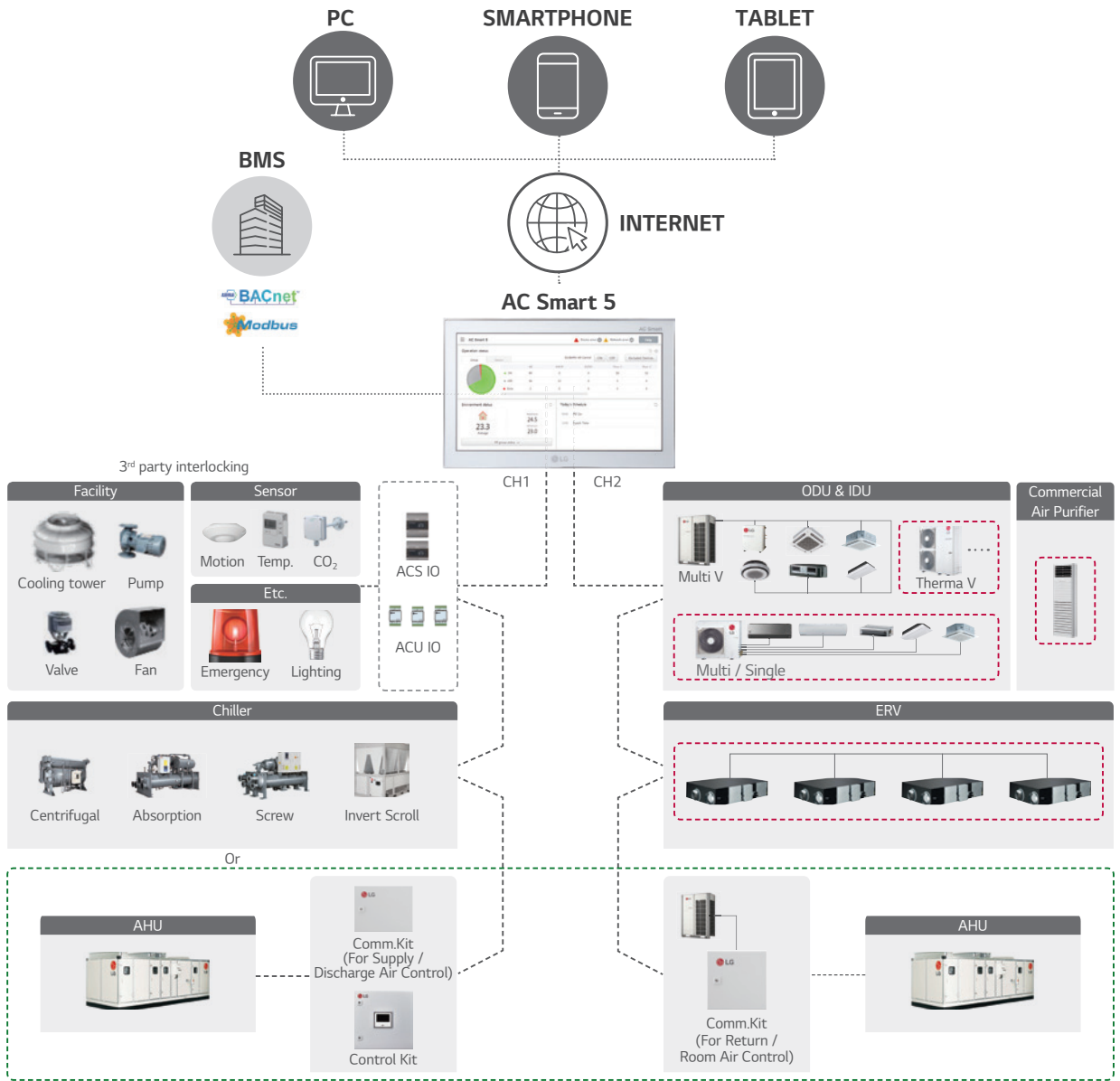

- ⌘ According to CH1 setting, normal ODU can be connected to CH1. (Flexible wiring design with 2 ports)
- ⌘ Appropriate PI485 should be used according to PDB (Product Data Book).
- ⌘ For details, refer to the product PDB or manual.

AC Smart 5

PACS5A000

10-inch touch screen with HTML5 GUI (Graphic User Interface) for easy control.



Max. 128 IDU control



Schedule



Map view
(Visual navigation)



Energy monitoring



Air Purify



Multi level grouping

MODEL NAME	PACS5A000
Size (W x H x D, mm)	253.2 x 167.7 x 28.9
Interfaceable Products	MULTI V / ERV / ERV DX / Hydro kit / THERMA V / AHU Kit / LG Chiller / Commercial Air Purifier
Maximum number of units	128
Individual / Group Control	On & Off / Mode / Temperature / Fan speed
Individual Controller Lock	Temperature / Mode / Fan speed / All
Advanced Function Setting and Display ¹⁾	Comfort Cooling / ODU Low Noise / ODU Defrost Mode / Comfort Level display / CO ₂ Level display (for ERV / ERV DX) / Night Time Free Cooling (for ERV / ERV DX)
Error Check	○
Slave Mode (Interlocking with higher level controller)	○
Schedule	Weekly / Monthly / Yearly / Exception day
Web Access	○
Emergency Stop & Alarm Display	○
Power Consumption Monitoring (with PDI)	○
Auto Changeover / Setback	○
Temperature Limit	○
Operation Time Limit	○
Visual Navigation	○
Operation Trend	○
Air Purify Control	○
Air Quality Level	○
Interlock Control	○
Virtual Group Control	○
ODU Capacity Control	○
Energy Navigation (with PDI)	○
Daylight Saving Time	○
External IO Port	DI 2 / DO 2
BMS Integration ²⁾	BACnet IP / Modbus TCP
IPv6 Support	○

※ ○ : Applied, - : Not Applied

1) It is only available in some products.

2) For the detail point list, please refer to the installation manual.

AC Smart 5

Air Purify Total Solution

Air Purify Control

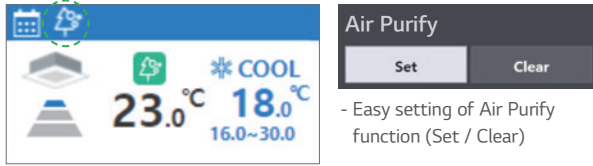

Air Quality Level Monitoring



System Air Conditioner

Commercial Air Purifier

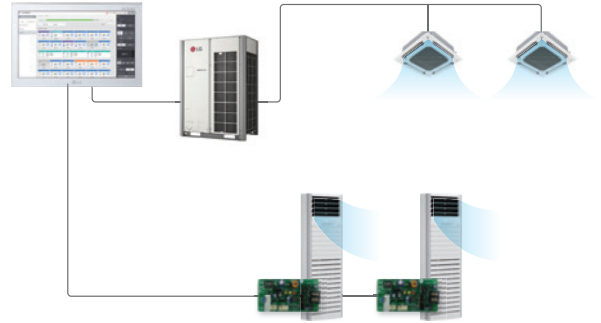

* The Commercial Air purifier must additionally install PI485(PHNFP14A0).

Advanced Network Accessibility

AC Smart 5 reflects the state of the art of network technology trend. IPv6 (Internet Protocol version 6), which is the most recent version of the Internet Protocol provides accessibility to the IPv6 compatible network environment. In addition, HTML5 allows you to easily control LG HVAC system on a variety of platforms (PC, Mobile, Tablet), at any time and from any location, not just on the touch screen.



Visualized Control

Visual navigation enables controlling and monitoring the unit on floor, plan view for the intuitive management.

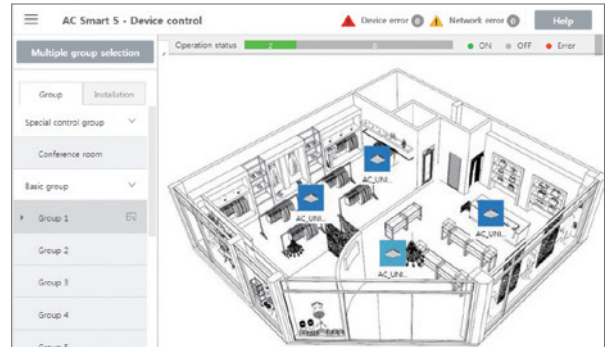

Multi Level Group Composition

User can make frequent and multi level group to control and monitor the device easily.



Energy Management

The energy navigation function allows the air conditioner's operational energy usage to be managed monthly, weekly and yearly. By analyzing present energy consumption and comparing with the plan, overuse of system operational costs can be prevented.

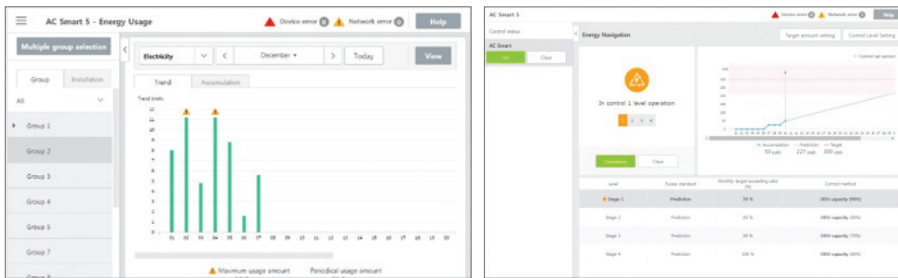

Building Management System (BMS) Integration

Without additional device, AC Smart 5 provides BACnet IP & Modbus TCP interface for BMS integration as well as its own management function.

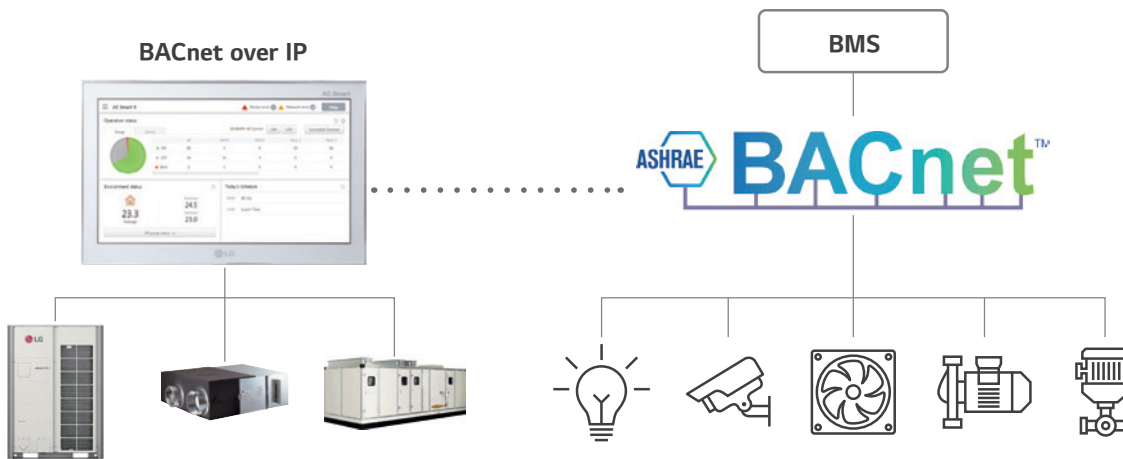

Interlocking with 3rd Party Equipment

AC Smart 5 can make operation scenario with 3rd party equipment by ACS IO Module and ACU IO Module. Control coverage is expanded.

(Air conditioner only → Sensors, Fans, Pumps, Switches...)

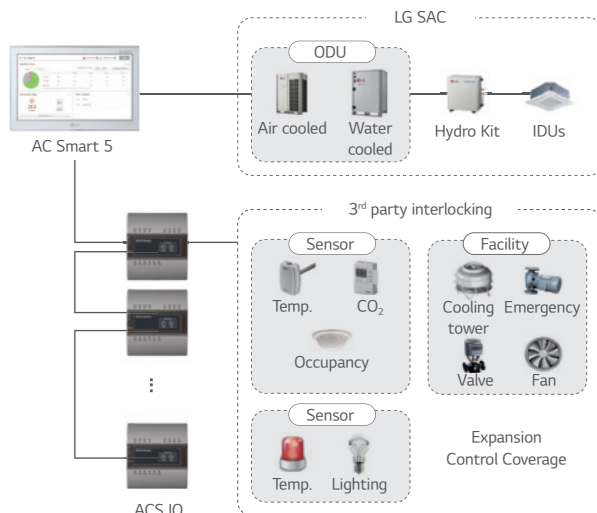

ACP 5

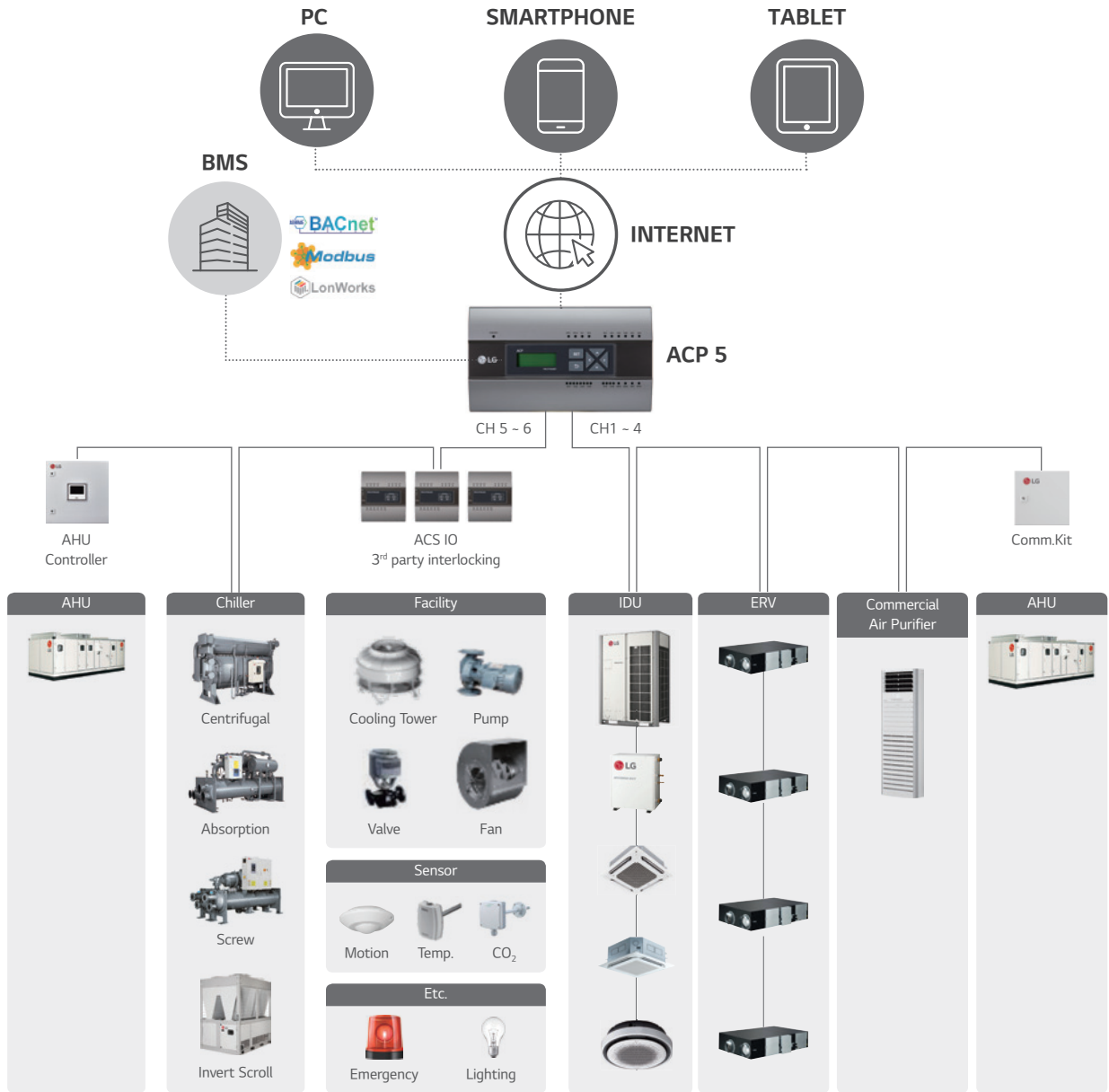

Advanced Network Accessibility



* Fix Public IP is mandatory.
 * Router's Configuration of NAT is mandatory. Open port 80 & 9300.

Energy Navigation



BACnet IP & Modbus TCP

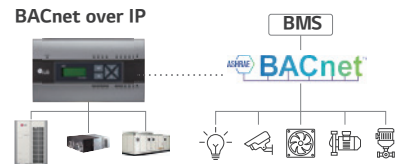

PACP5A000

Advanced solution for BMS integration up to 256 units via BACnet and Modbus protocol as well as its own smart management function with web server interface.



MODEL NAME	PACP5A000
Size (W x H x D, mm)	270 x 155 x 65
Interfaceable Products	MULTI V / ERV / ERV DX / Hydro kit / THERMA V / AHU Kit / LG Chiller / Commercial Air Purifier
Maximum number of units	256
Individual / Group Control	On & Off / Mode / Temperature / Fan speed
Individual Controller Lock	Temperature / Mode / Fan speed / All
Advanced Function Setting and Display ¹⁾	Comfort Cooling / ODU Low Noise / ODU Defrost Mode / Comfort Level display / CO ₂ Level display (for ERV / ERV DX) / Night Time Free Cooling (for ERV / ERV DX)
Error Check	○
Schedule	Weekly / Monthly / Yearly / Exception day
Web Access	○
Emergency Stop & Alarm Display	○
Power Consumption Monitoring (with PDI)	○
Auto Changeover / Setback	○
Temperature Limit	○
Operation Time Limit	○
Visual Navigation	○
Operation Trend	○
Air Purify Control	○
Air Quality Level	○
Interlock Control	○
Virtual Group Control	○
ODU Capacity Control	○
Energy Navigation (with PDI)	○
Daylight Saving Time	○
External IO Port	DI 10 / DO 4
BMS Integration ²⁾	BACnet IP / Modbus TCP
IPv6 Support	○

※ ○ : Applied, - : Not Applied

1) It is only available in some products.

2) For the detail point list, please refer to the installation manual.

Air Purify Control / Monitoring

Integrated Management

The Commercial Air Purifier can be used with LG central controller to monitor and control.

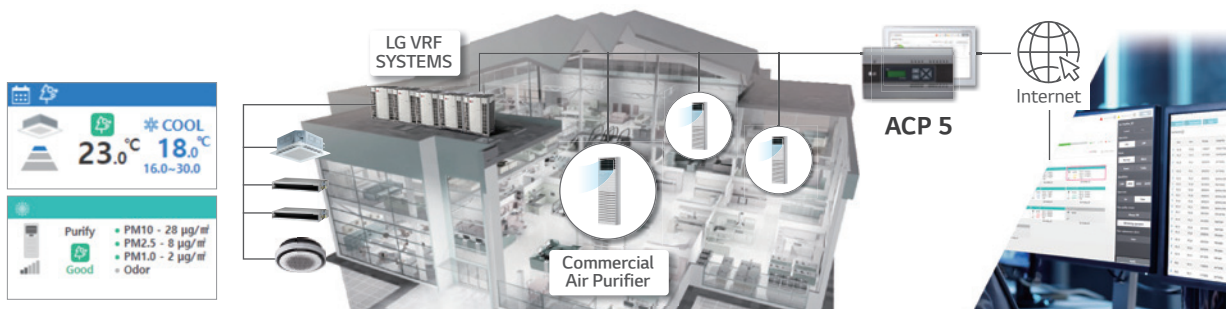

For Lonworks

For using Lonworks Protocol, Only ACP 5 provides interface for BMS integration, And, need to U60FT Module between ACP 5 and BMS System Interface between Lonworks FT-10 BMS and LG HVAC unit

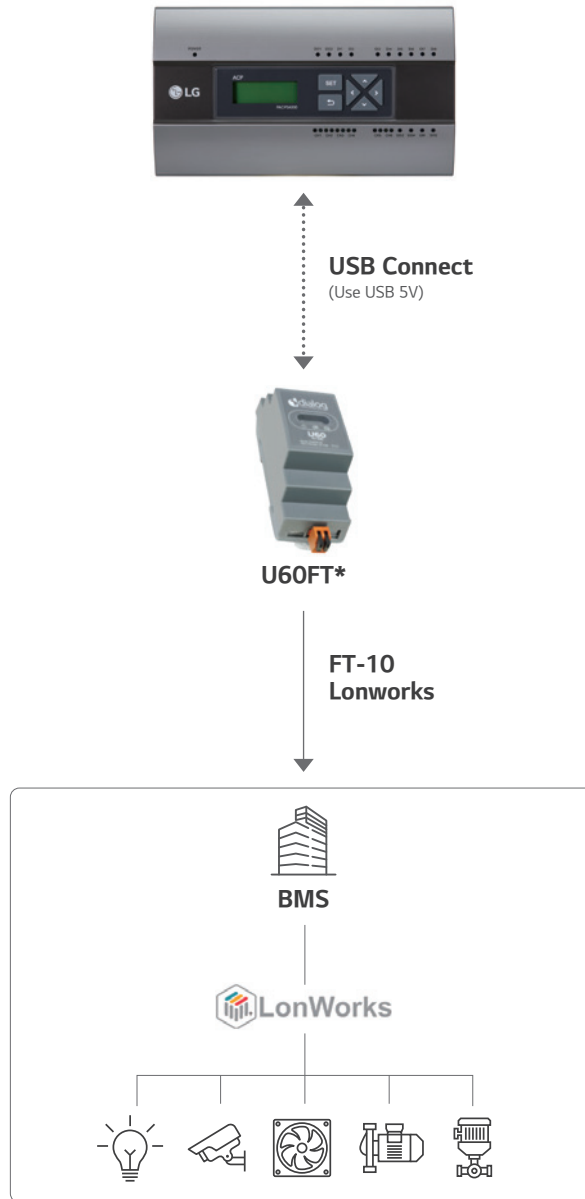

UNIT TYPE	BACNET IP	MODBUS TCP	LONWORKS
IDU	○	○	○
ERV, DX ERV	○	○	○
ODU	Monitoring Only	-	-
Heating	○	○	○
AHU	○	○	-
Scroll Air Inv Gen2	○	-	-
EXP I/O	○	-	-
Air Purifier	○	-	-

※ ○: Applied, - : Not applied

*U60FT : This device should be purchased separately from 3rd party supplier. Please contact regional LG office for more detailed information.

CONTROL	MONITORING
On / Off Command	On / Off
Operation Mode Setting	Operation Mode
Lock	Lock
Temperature	Temperature
Fan Level	Fan Level
Fan Direction Auto	Fan Direction Auto
Mode Lock	Mode Lock
Fan Level Lock	Fan Level Lock
Temperature Lock	Temperature Lock
Temperature Lower Limit	Temperature Lower Limit
Temperature Higher Limit	Temperature Higher Limit
Peak Convert Cycle	Peak Convert Cycle
Peak Setting	Peak Setting
Temperature Unit	Temperature Unit
Total Temperature Lock	-
Total On / Off	-
Total Temperature	-
-	Product Type
-	Product Address
-	Current Temperature
-	Alarm
-	Power
-	Error Code
-	Peak Current Operating Percent
-	Total Accumulate Power

※ O : Applied, - : Not Applied

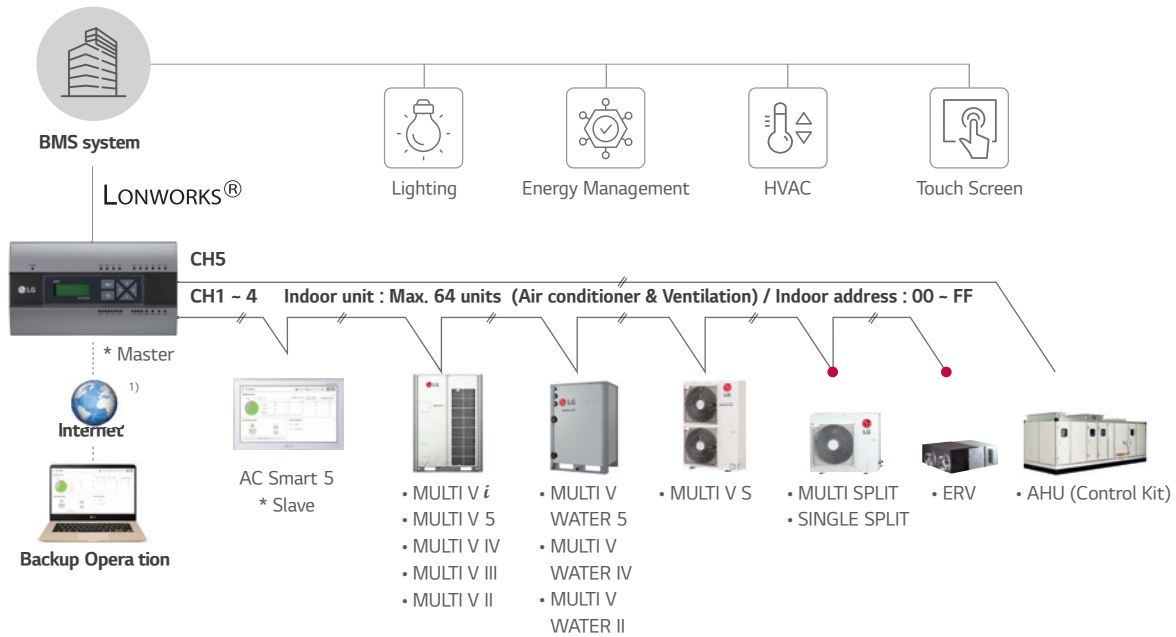

1) Assignment of public IP address is required to access central controller through internet.

● Appropriate PI485 should be used according to PDB (Product Data Book).

AC Manager 5

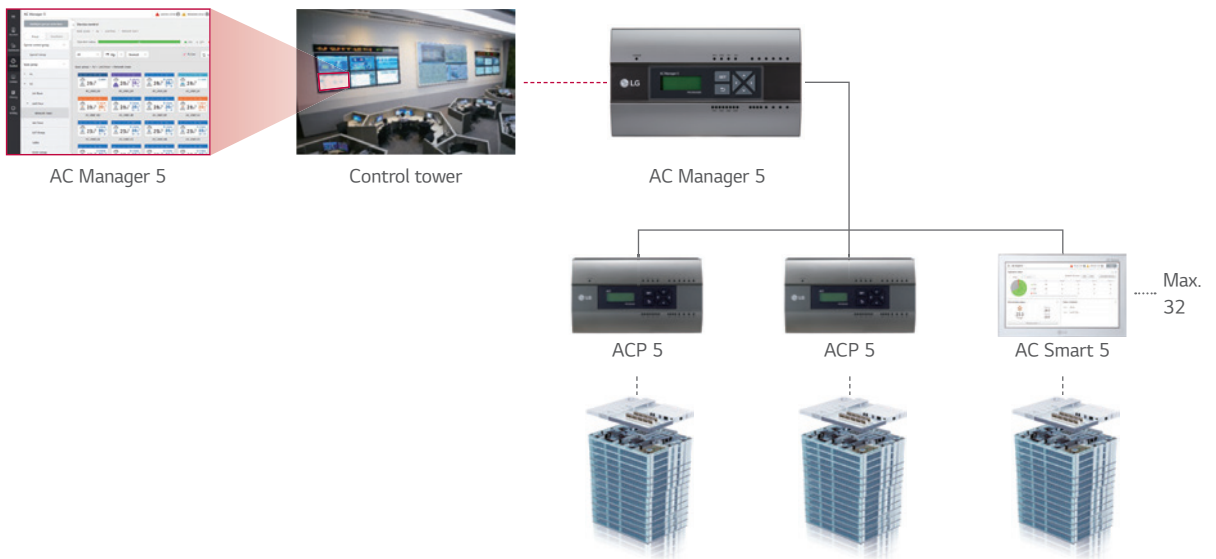
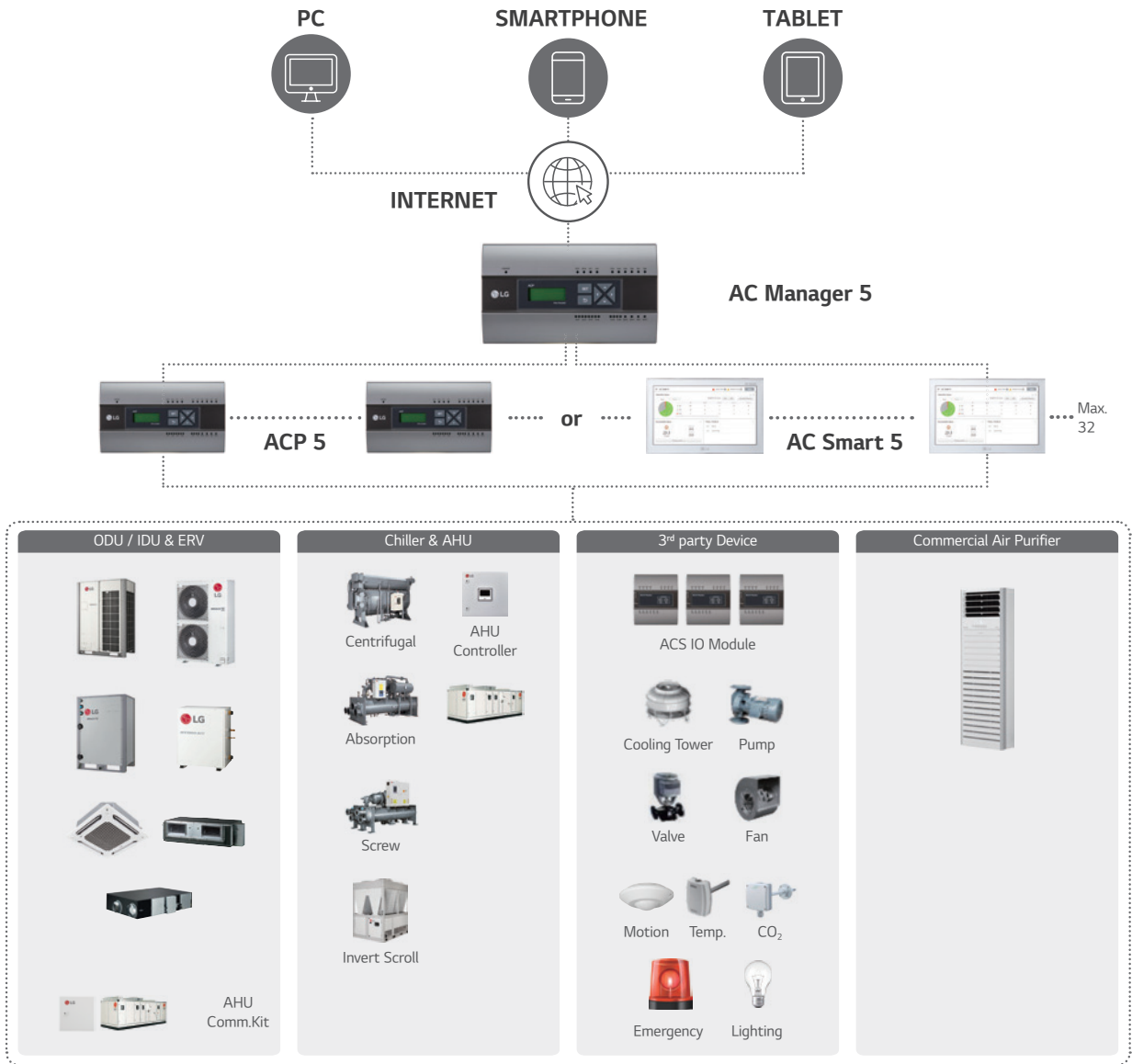

PACM5A000

Multiple ACP and AC Smart integration solution to manage multi sites up to 8,192 units as a single system.



reddot award
User Interface Design

MODEL NAME	PACM5A000
Size (W x H x D, mm)	270 x 155 x 65
Interfaceable Products	MULTI V / ERV / ERV DX / Hydro kit / THERMA V / AHU Kit / LG Chiller / Commercial Air Purifier
Maximum number of units	8,192 (Supports 32 ACP 5 or AC Smart 5)
Individual / Group Control	On & Off / Mode / Temperature / Fan speed
Individual Controller Lock	Temperature / Mode / Fan speed / All
Error Check	○
Schedule	Weekly / Monthly / Yearly / Exception day
Web Access	○
Emergency Alarm Display	○
Power Consumption Monitoring (with PDI)	○
Auto Changeover / Setback	○
Temperature Limit	○
Operation Time Limit	○
Visual Navigation	○
Operation Trend	○
Air Purify Control	○
Air Quality Level	○
Interlock Control	○
Virtual Group Control	○
ODU Capacity Control	○
Energy Navigation (with PDI)	○

※ ○ : Applied, - : Not Applied

Note : AC Manager 5 required for ACP 5 or AC Smart 5

Up to 8,192 Connections for Indoor Units

Administrators can easily and conveniently manage a variety of LG HVAC equipment. Also, it is available to manage many buildings or areas at one place via AC Manager 5.



AC Manager 5

Smart Air Purify Solution

Total management of air purify function creates clean environment everyday.

Air Quality Multi Sta tus view

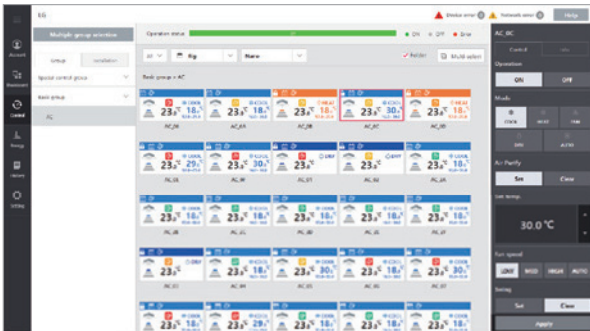

Air Quality Summary Widget

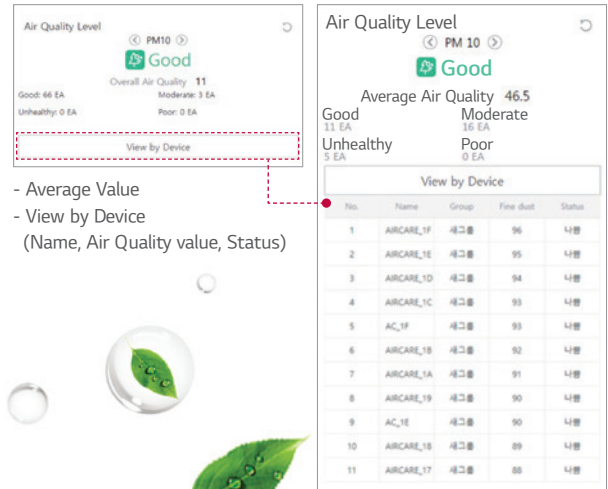

- Average Value
- View by Device (Name, Air Quality value, Status)

Air Purify Control

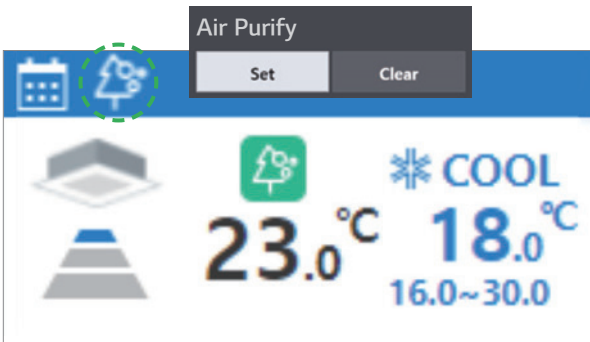

- Easy setting of Air Purify function (Set / Clear)

View Air Quality Trends

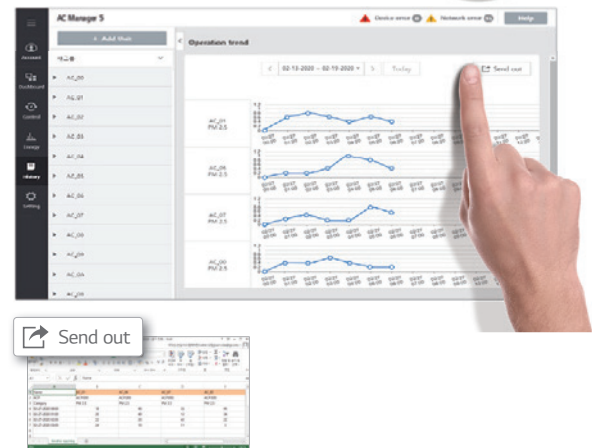

- Daily (per hour), period (30 days) shows trends
- Excel output / easy to manage

Advanced Network Accessibility & User Friendly GUI

As an advanced central controller, AC Manager 5 offers flexible interface for each user by assessing the device screen and automatically customizing the layout to provide the most optimized interface.



Energy Navigation & Energy Usage Graph

Energy navigation is the function to set the target usage amount to limit the monthly power consumption and to control so that the total accumulated power consumption does not exceed the target usage amount. It performs total of 7 control levels with the estimated / actual usage amount exceeding ratio compared to the monthly target usage amount. For the control method, there are indoor unit operation ratio, outdoor unit capacity control, and indoor unit operation control.

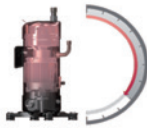
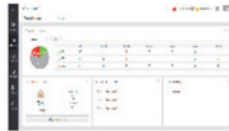

Compressor Capacity Control



IDU Operation Ratio Control

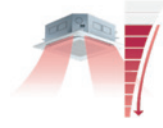

IDU Operation Level

Peak Control

This function can reduce electricity use. There are two kinds of control logic. Energy saving effect by indoor unit operation rate control. Load management effect by outdoor unit capacity control.

Operation ratio (IDUs) Control



ODU Capacity Control

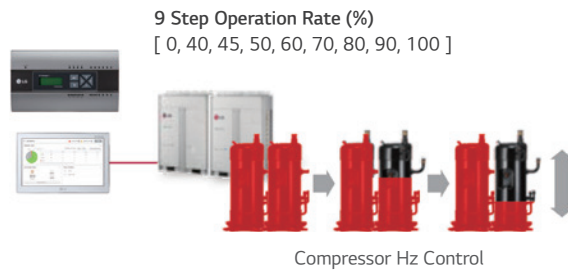

Multi Level Group Composition

User can make frequent and multi level group to control and monitor the device easily.

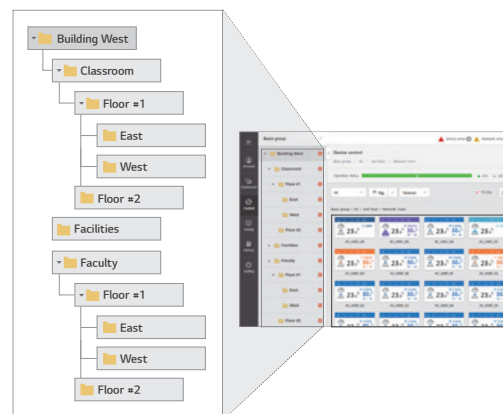

MODBUS RTU Gateway

PMBUSB00A

Providing Modbus RTU connection between LG Air conditioners and BMS.



Features & Benefits

- Function
 - Modbus RTU communication with Modbus master controller
 - Modbus RTU slave (RS485) / 9,600 bps
 - Applicable for MULTI V ĩ, MULTI V 5, ERV, Heating
 - Size (W x H x D, mm) : 53.6 x 89.7 x 60.7
 - Max. 16 IDUs with single module / Max. 64 IDUs with 4 modules
 - Power : DC 12V (250mA)
 - No slave allowed in LGAP

Installation Scene

Single Module

Max. 16 indoor units with a single module

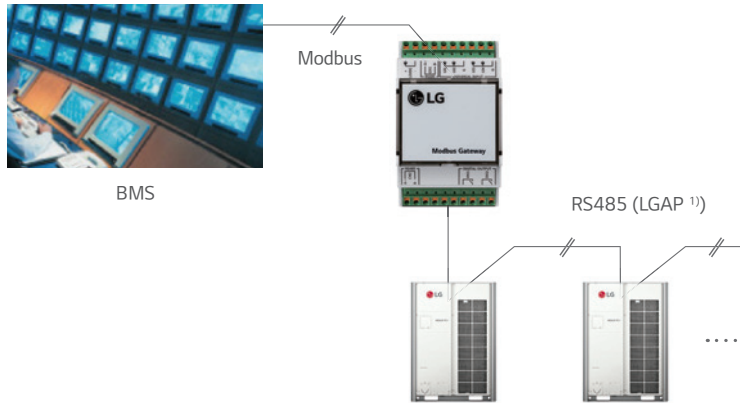

Multiple Module

Max. 64 indoor units with 4 modules in one Modbus communication line

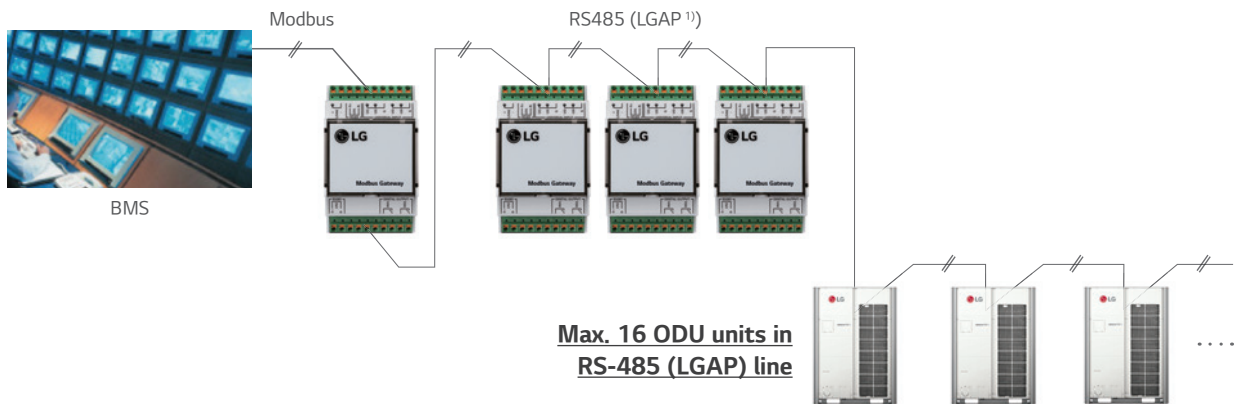

1) LGAP is LG Protocol.
Max. 16 ODU units in RS-485

Modbus Gateway Memory Map

Baud Rate : 9,600 bps, Stop Bit : 1 stop bit, Parity : None Parity, Byte size : 8 bits

Coil Register (0 x 01)

NO.	DATA BIT			FUNCTION	REGISTER
	AIR CONDITIONER	ERV / DX ERV	HYDRO KIT & THERMA V		
1	Operate (On / Off)	Operate (On / Off)	Operate (On / Off)	0 : Stop / 1 : Run	Register = N X 16 + ① (N = Indoor Unit Cental Address)
2	Auto Swing	Aircon Operate (On / Off)	Hot Water Mode (On / Off)	0 : Disable / 1 : Enable	
3	Filter Alarm Release	Filter Alarm Release ¹⁾	Reserved	0 : Normal / 1 : Alarm Release	
4	Lock Remote Controller	Lock Remote Controller	Lock Remote Controller	0 : UnLock / 1 : Lock	
5	Lock Operate Mode	Lock Operate Mode ¹⁾	Reserved	0 : UnLock / 1 : Lock	
6	Lock Fan Speed	Lock Fan Speed ¹⁾	Reserved	0 : UnLock / 1 : Lock	
7	Lock Target Temp.	Lock Target Temp. ¹⁾	Reserved	0 : UnLock / 1 : Lock	
8	Lock IDU Address	Lock IDU Address ¹⁾	Reserved	0 : UnLock / 1 : Lock	
9	Reserved	Quick Ventilate	Reserved	0 : Disable / 1 : Enable	
10	Reserved	Energy Save	Reserved	0 : Disable / 1 : Enable	

1) : This register value is applied 'DX Ventilator' ONLY.

Discrete Register (0 x 02)

NO.	DATA BIT			FUNCTION	REGISTER
	AIR CONDITIONER	ERV / DX ERV	HYDRO KIT & THERMA V		
1	Connected IDU	Connected IDU	Connected IDU	0 : Disconnected / 1 : Connected	Register = N X 16 + ① (N = Indoor Unit Cental Address)
2	Alarm	Alarm	Alarm	0 : Normal / 1 : Alarm	
3	Filter Alarm	Filter Alarm ¹⁾	Hot Water Only ²⁾	• 0 : Normal / 1 : Alarm Hydro Kit • 0 : Normal / 1 : Hot Water Only	
4	Reserved	Reserved	Target Temp. Select	0 : Air / 1 : Water	
5	Reserved	Reserved	Error Division ²⁾	0 : CH type error / 1 : BC type error	

1) : This register value is applied 'DX Ventilator' ONLY.

2) : This register value is applied 'Hydro Kit' ONLY.

Holding Register (0 x 03)

NO.	DATA BIT			FUNCTION	REGISTER
	AIR CONDITIONER	ERV / DX ERV	HYDRO KIT & THERMA V		
1	Operate Mode	Operate Mode	Operate Mode	• 0 : Cooling, 1 : Dehumidifying, 2 : Fan, 3 : Auto, 4 : Heating Hydro Kit (Middle Temp. DHW) / AWHP • 0 : Cooling, 3 : Auto, 4 : Heating Hydro Kit (High Temp. DHW)	Register = N X 20 + ① (N = Indoor Unit Cental Address)
2	Fan Speed	Fan Speed	Target Temp. DHW ²⁾	1 : Low, 2 : Mid, 3 : High, 4 : Auto	
3	Target Temp.	Target Temp. ¹⁾	Target Temp. ²⁾	16.0 ~ 30.0 [°C] x 10	
4	Target Temp. Limit (Upper)	Target Temp. Limit ¹⁾ (Upper)	Reserved	16.0 ~ 30.0 [°C] x 10	
5	Target Temp. Limit (Lower)	Target Temp. Limit ¹⁾ (Lower)	Reserved	16.0 ~ 30.0 [°C] x 10	
6	Reserved	Vent. Operate Mode	Reserved	0 : HEX, 1 : Auto, 2 : Normal	

1) : This register value is applied 'DX Ventilator' ONLY.

2) : This value range can be between 0 ~ 127 [°C]. And it would be limited by upper & lower value according to the setting of remote controller.

Input Register (0 x 04)

NO.	DATA BIT			FUNCTION	REGISTER
	AIR CONDITIONER	ERV / DX ERV	HYDRO KIT & THERMA V		
1	Error Code	Error Code	Error Code	0 ~ 255 ※ Please refer to the product error table.	Register = N X 20 + ① (N = Indoor Unit Cental Address)
2	Room Temp.	RA Temp.	Room Temp.	-99.0 ~ 99.0 [°C] x 10	
3	Pipe In Temp.	OA Temp. ¹⁾	Water Inlet Temp.	-99.0 ~ 99.0 [°C] x 10	
4	Pipe Out Temp.	SA Temp. ¹⁾	Water Outlet Temp.	-99.0 ~ 99.0 [°C] x 10	
5	Reserved	Pipe In Temp. ¹⁾	Sanitary Tank Temp.	-99.0 ~ 99.0 [°C] x 10	
6	Reserved	Pipe Out Temp. ¹⁾	Solar Temp. ²⁾	-99.0 ~ 99.0 [°C] x 10	

1) : This register value is applied 'DX Ventilator' ONLY.

2) : This register value is applied 'AWHP' ONLY.

KNX Gateway

Technical and service support must come from Intesis directly.
 LG Electronics Inc. warrants and assumes no liability for this product.
 - This is the landing page of INTESIS MAPS: <https://www.intesis.com/products/intesis-maps-home>.

INKNXLGE0160036 (Indoor Unit ~16) / INKNXLGE0640036 (Indoor Unit ~64)

Specially designed to allow monitoring and bidirectional control of all the parameters and functionality of LG air conditioners from KNX protocol.



Key features

- 2 model types
- Up to 64 connectable indoor units
- Direct connection to KNX TP1 bus
- Independent management of communications
- Power supply : 9 to 36V DC or 24V AC (not included)
- KNX Power consumption : 5mA
- Standard DIN-Rail 6 modules enclosure
- LG Slave Central controller (for example, AC Smart) and PDI can be operated with KNX gateway

Key benefits

- Easy & quick installation : user comfort
- Flexible integration (Intesis MAPS & KNX) Export Group Address by "csv" file to ETS5/6
- Compatibility with all LG products (Air-Conditioning, ERV, Hydrokits and AWHP)
- Ergonomic & friendly user interface (using the supplied software Intesis MAPS)
- One single tool for settings, commissioning, SW update and troubleshooting

Key messages

- Manage your building with an advanced building automation solution
- Energy savings
- Power consumption measurement using additional LG PDI device
- Bidirectional communication between LG & KNX
- Your system diagnostics accessible through LG Error codes

MODEL NAME	MAX. CONNECTION INDOOR UNITS
INKNXLGE0160036	16
INKNXLGE0640036	64

Intesis MAPS is Configuration Software for Intesis KNX Gateway Series

Easy to use tool for the configuration of Intesis gateway, in a fast and effective way.
 It offers the maximum integration possibilities with a minimal knowledge required on the system to be integrated.

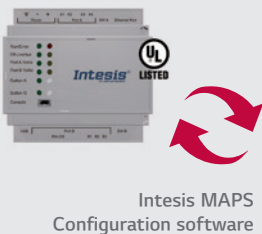

- Only needed during configuration.
- One single tool for the configuration of the whole range of Intesis KNX gateway series.
- Supplied with Intesis gateway with no additional cost.
- Configuration examples for all systems that can be integrated.
- Mapping table editable using excel, allowing a simple and fast association of KNX Group Addresses, exported from ETS, to Intesis gateway's datapoints.
- Includes powerful and useful features for configuration, setup and troubleshooting.

Installation Scene

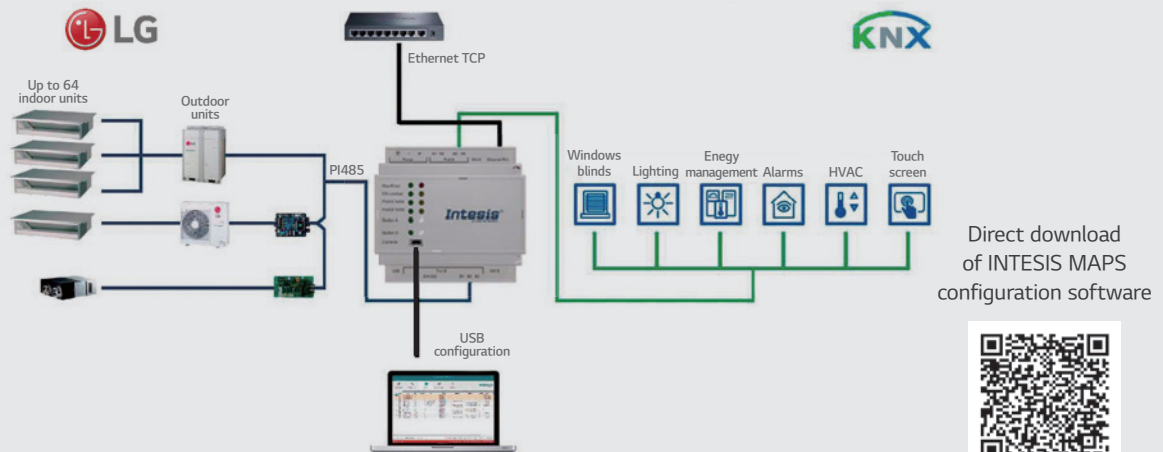

Direct download of INTESIS MAPS configuration software



Integration of LG VRF systems into KNX control systems

INKNXLGE001R000 (For Indoor Unit)

LG-KNX gateway allows fully bi-directional communication between LG VRF systems and KNX installations.

One gateway, one AC unit : This is the solution of **ONE-TO-ONE** integration. All required KNX DPT objects are full compatible with all KNX thermostats in the market. The gateway is wired directly to an indoor unit. This allows not only the control of the main AC functions such as operating mode, fan speed, temperature setpoint, also monitoring errors and alarms.



Key features

- KNX certified.
- Configured by ETS standard configuration tool.
- KNX database available on ETS5 / 6
- Reduced dimensions allowing a quick installation inside the Air Conditioner unit.
- Offered all the required DPT objects 100% be compatible with all KNX thermostats in the market.
- Energy efficiency functions, such as "timeout", "open window" or "Occupancy".
- Smooth integration of KNX thermostats allowing the control of the AC unit by the own temperature sensor of the thermostat (Virtual Temperature)
- Simultaneous control of the AC unit by LG remote controller and KNX.

Key benefits

- Optimization cost for small or medium installations.
- Decentralized device control : one gateway connected to each indoor unit.
- Easy integration on KNX installations
- Intuitive configuration

Key messages

- Total control and monitoring of the AC unit from KNX, including AC unit's internal variables, running hours counter (for filter maintenance control) and error indication (CH Error Codes).
- Fully integrated solution on Engineering Tool Software ETS5 / 6 by database product

KNX LG solution concept

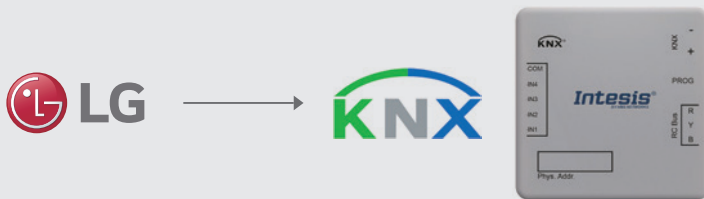

Installation Scene & LG Topology

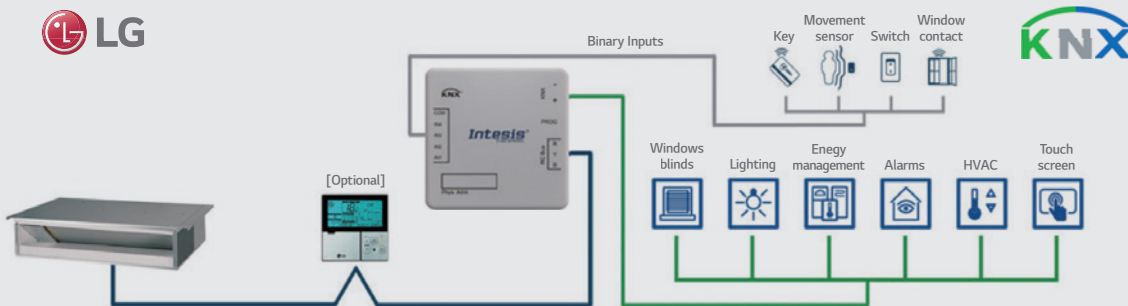

KNX Product

Database available directly on ETS5/6 under INTESIS manufacturer

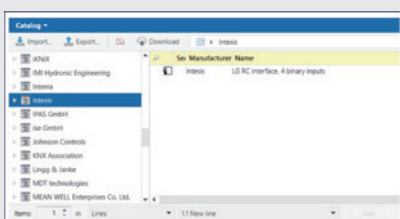

Configuration by ETS Data Base

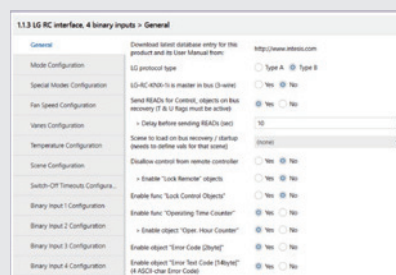

Web landing page of the product



PI485

PI485 converts LG Air conditioners protocol to the RS485 protocol for the central controller.

PMNFP14A1

Easy to manage up to 64 indoor units.

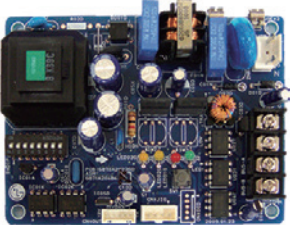

- Power : Single phase AC 220V 50 / 60Hz

- **1 for Each Outdoor Unit**

- Multi V MINI (ARUN40GS2A / ARUV40GS2A Only needs PI485)
- Single Split
- Multi Split

PP485A00T

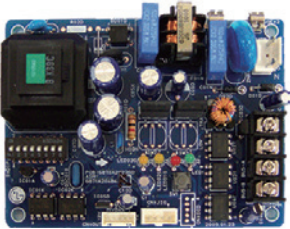

- Power : Single phase AC 220V 50 / 60 Hz

- **1 for Each Indoor Unit**

- Therma V

PHNFP14A0



- Power : Connected with the Indoor Units

- **1 for Each Indoor Unit**

- Indoor Unit (ERV)

INTEGRATION DEVICE





INTEGRATION DEVICE

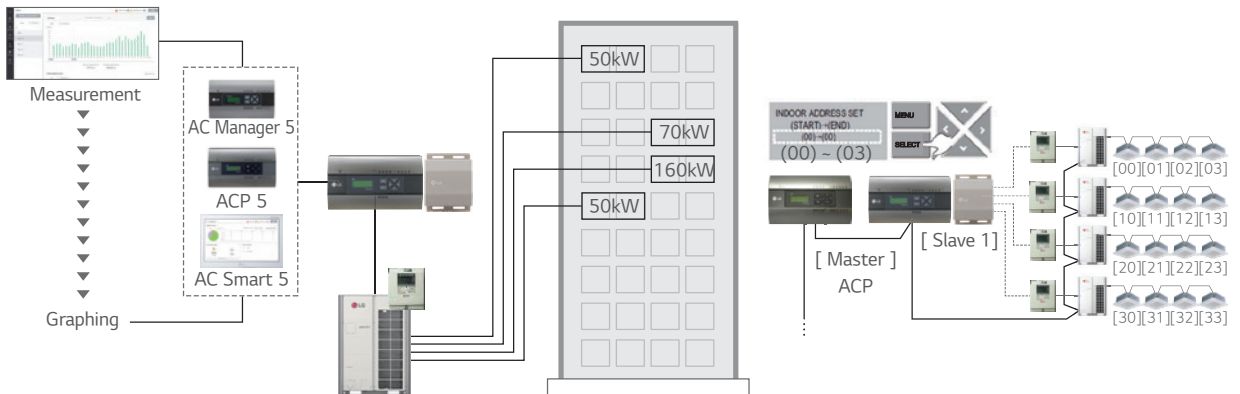
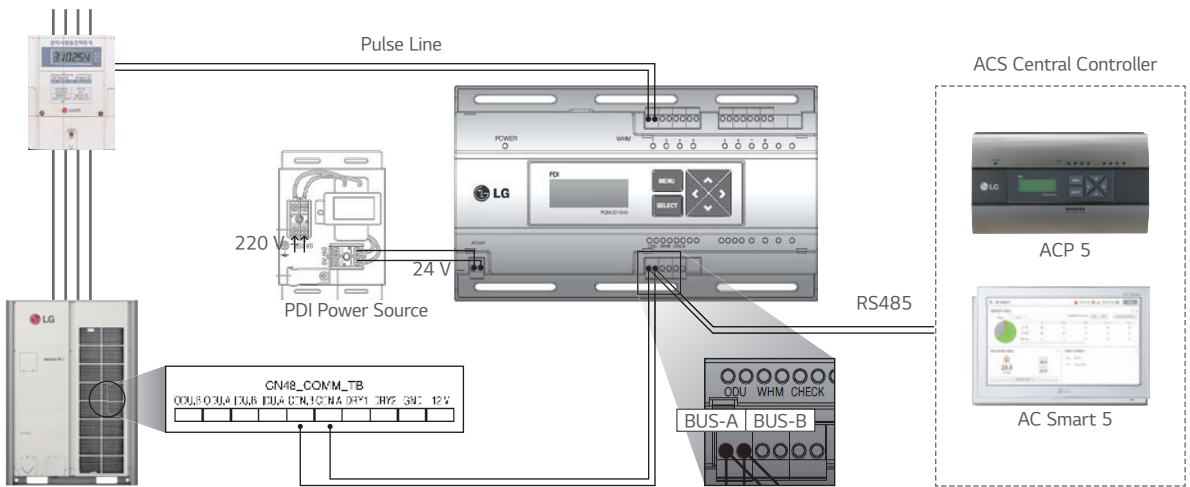

- Note :
1. Power cable and type could be different from this scene depending on the Outdoor unit's specification.
 2. Measured power consumption could be different between PDI and Watt meter.
 3. Applicable Central Controller : ACP 5, ACP LonWorks, AC Smart 5, AC Ez Touch
(Combination : we recommend to connect separated watt meter for Outdoor units to have correct power distribution value)

PDI (Power Distribution Indicator)

PQNUD1S40 (Premium, 8 ports) / PPWRDB000 (Standard, 2 ports)

PDI shows distributed power consumption of up to 128 indoor units.

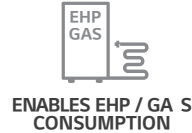
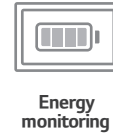
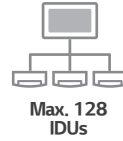

Features & Benefits

- Enables total and indoor power consumption monitoring.
- With LG central control connectivity, energy monitoring, energy savings operations and target usage setting functions are enabled.
- Enables gas consumption and electricity distribution.

MODEL NAME	PQNUD1S40	PPWRDB000
Size (W x H x D, mm)	270 x 155 x 65	
Interfaceable Products	Air conditioner, ERV DX, Hydro kit, Thermal V	
Maximum Number of Power Meters	EHP : 8 Watt meter GHP : 4 Watt meter / 4 Gas meter	EHP : 2 Watt meter GHP : 1 Watt meter / 1 Gas meter
Maximum Number of Indoor Units	EHP : 128 GHP : 64	
Data Backup When Power Outage	○	
Power Input	PDI : AC 24V, Transformer : AC 220V	

※ ○ : Applied, - : Not Applied

ACS IO Module

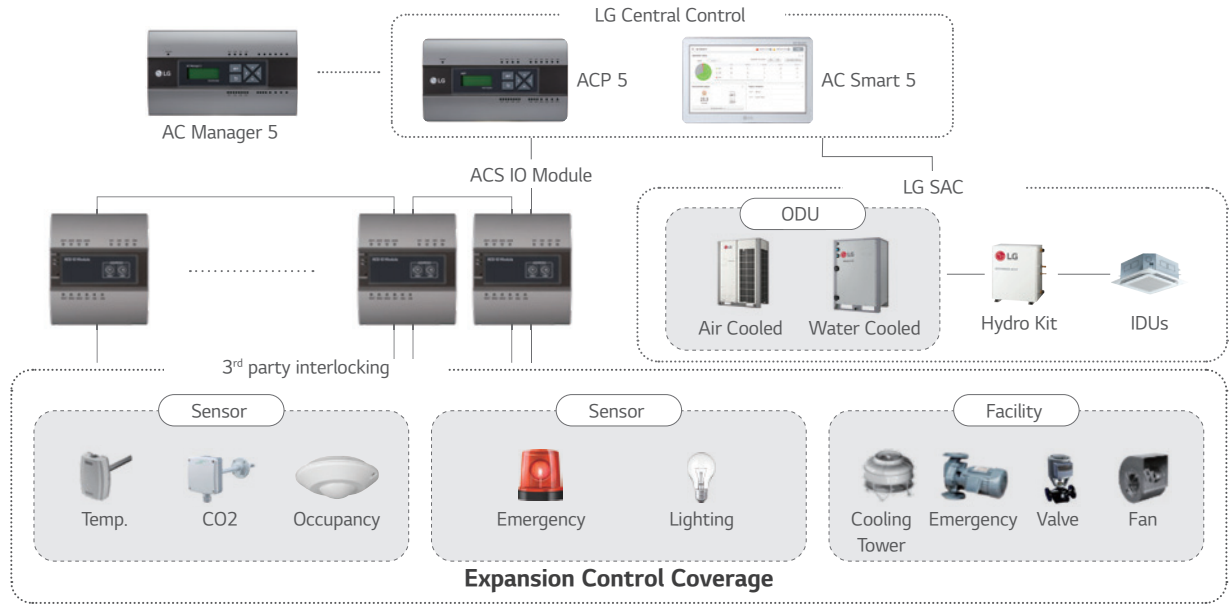

※ DI : Digital Input, DO : Digital Output, UI : Universal Input, AO : Analog Output

Case. 1

Parking Lot Ventilation

Turning on ventilator when CO₂ Level is high

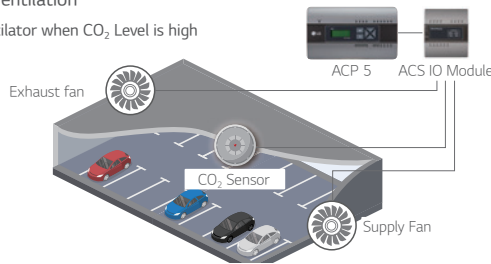

Case. 1

Auxiliary Heater

Turning on aux. heater when outside temp. is very low

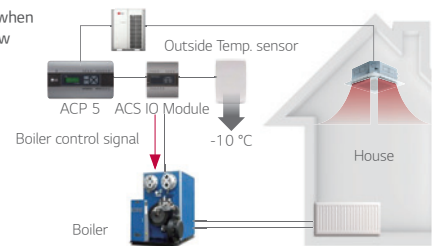

PEXPMB000

This module can be connected with ACP 5 or AC Smart 5 controller if additional I / O points such as DI / DO and AI / AO for 3rd party devices control and monitoring are needed.



Features & Benefits

- Interlocking with 3rd party equipment, LG Central controller can make operation scenario with 3rd party equipment by ACS IO Module.
- Control coverage is expanded. (Air conditioner only → Sensors, Fans, Pumps, Switches ...)
- Power : AC 24V (60Hz / 500mA)

MODEL NAME		PEXPMB000	
Linkable Products		PACS5A000, PACP5A000	
Communication	RS-485	1 ch	
I / O	Digital Input	3 ports	
	Digital Output	3 ports	
	Universal Input ¹⁾	4 ports	
	Analog Output	4 ports	
VALUE SPEC		MIN.	MAX.
Analog Input	NTC 10k	0.68kΩ	177kΩ
	PT 1000	803Ω	1,573Ω
	Ni 1000	871.7Ω	1,675.2Ω
	DC (Voltage)	0V	10V
	DC (Current)	0mA	20mA
Analog Output	-	0V	10V
Digital Input	Binary Input (Non Voltage)	-	-
Digital Output	Normal open	-	30VAC / 30VDC, 2A

※ O : Applied, - : Not Applied
 1) The type of UI (Universal Input) is selectable among Digital Input and Analog Input.
 Note : ACS IO & ACU IO are not a replacement for Direct Digital Controller(DDC) or PLC.

ACU IO Module

PEXPMB300, PEXPMB200, PEXPMB100

This module can be connected with ACP 5 or AC Smart 5 controller if additional I / O points such as UIO / UI / UO for 3rd party devices control and monitoring are needed.



ACU.UIO
PEXPMB300



ACU.UO
PEXPMB200



ACU.UI
PEXPMB100

Features & Benefits

- Interlocking with 3rd party equipment LG Central controller can make operation scenario with 3rd party equipment by ACU IO Module.
- Applicable devices are expanded. (Air conditioner only → Sensors, Fans, Pumps, Switches ...)
- Power : 12VDC / 250mA (External Power)

MODULE NAME	PEXPMB300	PEXPMB200	PEXPMB100
Linkable Products	PACS5A000, PACP5A000		
Communication RS-485	1 ch	1 ch	1 ch
Digital Input	-	-	3 ports
Digital Output	2 ports	6 ports	-
Universal Input ¹⁾	4 ports	-	6 ports
Analog Output	2 ports	4 ports	-

VALUE SPEC	MIN.	MAX.
Analog Input DC (Voltage)	0V	10V
Analog Output DC (Voltage)	0V	10V
Digital Input Binary Input (Non Voltage)	-	-
Digital Output Normal Open	-	30VDC, 1A

※ O : Applied, - : Not Applied

¹⁾ The type of UI (Universal Input) is selectable among Digital Input and Analog Input.

DRY CONTACT

PDRYCB000

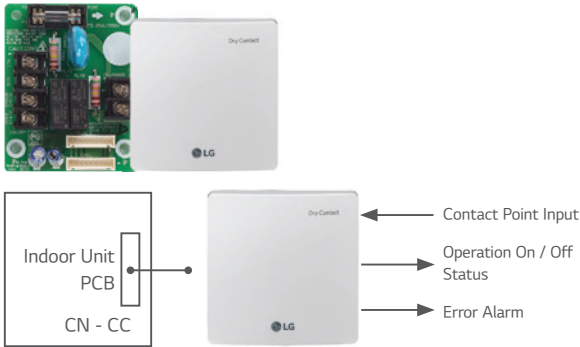

Simple Dry Contact (1 input)

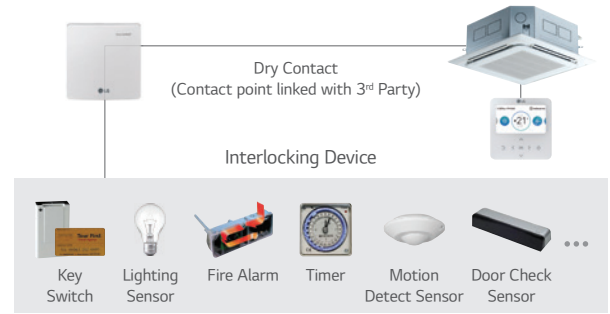

PDRYCB400

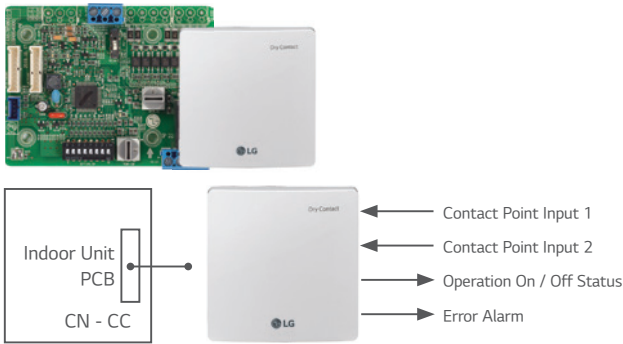

Dry Contact for 2 Input



Refrigerant Leakage Detection Alarm



PDRYCB320



Dry Contact for Thermostat

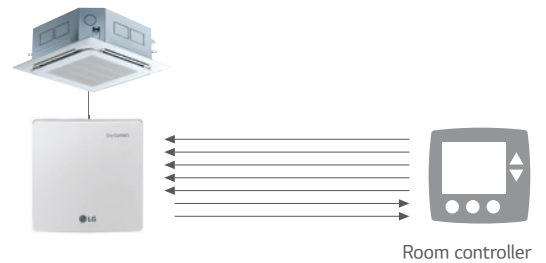

※ Please contact our regional office to have full compatible room controller list.

PDRYCB500 / PDRYCB510*

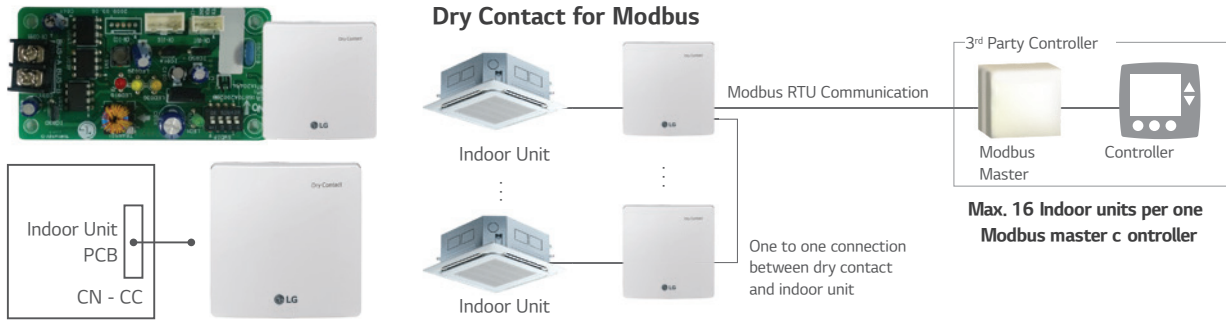

※ Please contact our regional office to check the compatibility with 3rd party room controller.
*No case for PDRYCB510

Specification

Connection between an indoor unit and external devices to control various functions.

MODEL NAME		PDRYCB000	PDRYCB400	PDRYCB320	PDRYCB500 / PDRYCB510*
Case		○	○	○	○
Input Port		1	2	8	-
Universal Input port		-	-	1	-
Comm. Protocol		-	-	-	Modbus RTU
Power		AC 220V	Connect to Indoor unit PCB (CN_CC) : DC 12V		
IDU	On / Off	○	○	○	○
	Operation Mode	-	○	○	○
	Set Temp.	-	(Select & Fix)	(Select & Fix)	○
	Fan Speed	-	-	○	○
	Thermo-Off	-	(Select & Fix)	○	-
	Energy Saving	-	(Select & Fix)	-	-
	Lock / Unlock	-	(Select & Fix)	-	-
Control	Heating	○	-	○	-
	DHW On / Off	-	-	○	-
	Thermo-Off	-	-	○	-
	Operation Mode	-	-	○	-
	Silent Mode	-	-	○	-
	Emergency Mode	-	-	○	-
ERV	On / Off	○	-	-	○
	Operation Mode	-	-	-	○
	Aircon Mode	-	-	-	○
	Additional Mode	-	-	-	○
	Fan Speed	-	-	-	○
Output	Operation Status	○	○	○	○
	Error	○	○	○	○
	Room Temp.	-	-	-	○

※ ○ : Applied, - : Not Applied
*No case for PDRYCB510

Note :
1. Compatibility of PDRYCB320
- Can use with all types of aircon indoor units after 2010.
(Cassette, Ducted, Convertible, Applied PAC, Wall mounted, Console)
- Can use with new single package AK-W model after 2020. 1Q
(The previous version Single package is not compatible)
- Heating : 3 series AWHP split and Monobloc models 4 generation Hydro Kit

2. Compatibility of PDRYCB400
- Can use with all types of air conditioner indoor units after 2010.
(Cassette, Ducted, Convertible, Applied PAC, Wall mounted, Console)
- Can use with new single package AK-W model after 2020. 1Q
(The previous version Single package is not compatible)
- Can not use with AWHP, Hydro Kit models.
3. (Select & Fix) : This function is preset by rotary switch.

Group Control Wire

PZCWRCG3

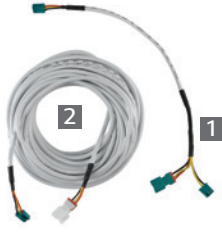

MODEL NAME	PZCWRCG3
1 Y-type Cable	0.25m Length
2 Long Cable	9.6m Length

Installation Scene

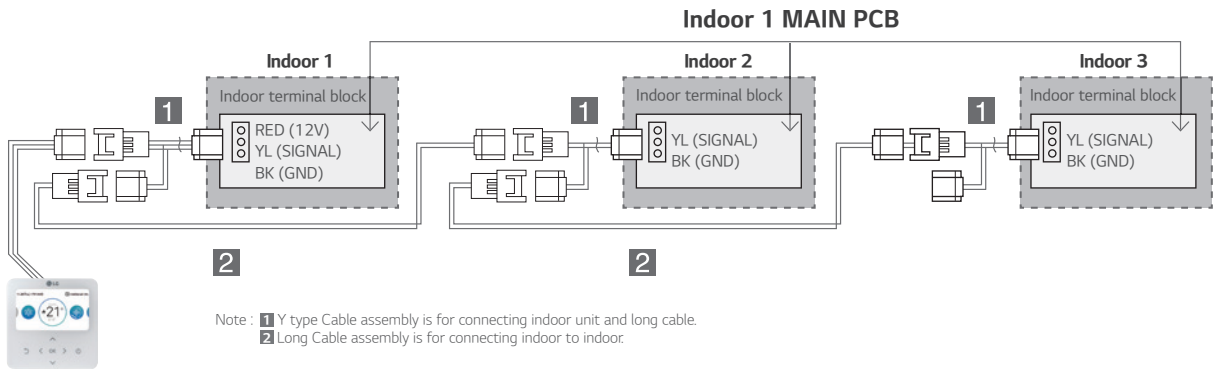

Remote Temperature Sensor

PQRSTA0

Sensor for detecting the room temperature.



Features & Benefits

- It detects the exact room temperature instead of indoor unit's air temperature sensor.
- Applied to Ceiling Mounted Cassette, Ceiling Concealed Duct, THERMA V and Hydro Kit.
- Extension cable (1.5m) is included.

Installation Scene

1. Wire to the control box in the indoor unit by removing the existing thermistor and connect the extension cable its place.
2. Cut the extension cable to the appropriate length and connect the screw terminal of the remote sensor.

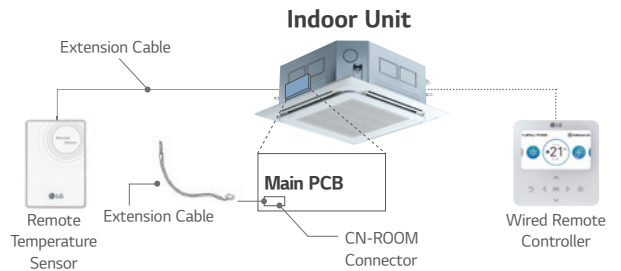

Zone Controller

ABZCA

Controls air conditioning in up to 4 zones by external thermostat.

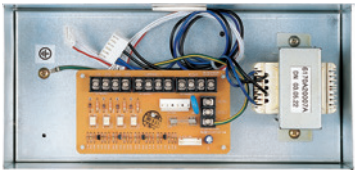

Features & Benefits

- Controls different zones (up to 4 zones) by external thermostat (AC 24V)
- Maintain proper air volume of each zone
- Auto variation of dampers
- Auto control of fan speed and On / Off operation

Installation Scene

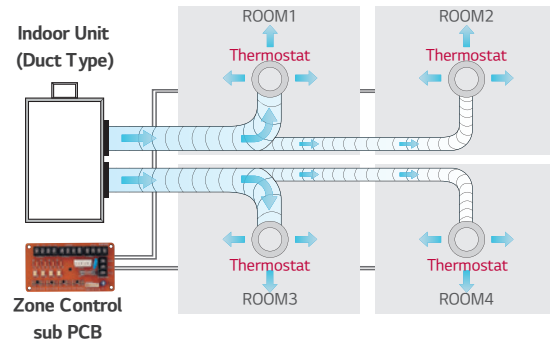
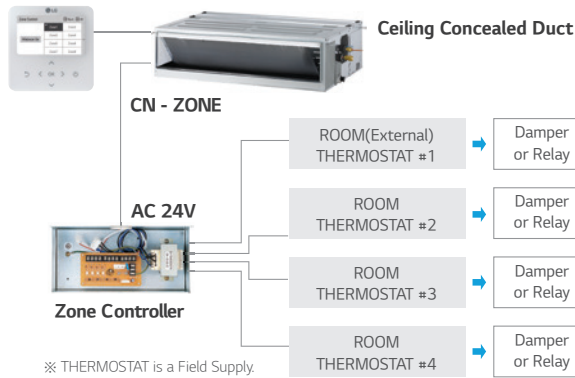

IO Module

PVDSMN000

Interface module between the outdoor unit of system air conditioner and the external device.



Features & Benefits

- Function
- Demand control
 - Low noise operation
 - Output outdoor or indoor unit operation status
 - Output error status

Description

- IO Module is communication interface module for connection between MULTI V *i* and external IO (Input / Output Module) devices.

Models Applied

- MULTI V IV, 5, *i*
- MULTI V WATER 5
- MULTI V S

Note : IO Module is not compatible for Multi V III and Multi V S R32.

Part Description

- 1) Digital Input Part (DI : Dry Contact Input)
 - Demand control by contact input (3 Step)
 - Low Noise Operation input
 - Priority Setting input : Setting the priority of demand control command (Capacity control for external signal from DDC vs Peak control by LG Central controller)
 - Open : External signal has priority to central controller (Default)
 - Close : Central controller has priority to external signal
- 2) Analog Input Part (AI : DC 0 ~ 10V)
 - Demand control by analog input (10 Step)
- 3) Digital Output Part (DO : AC 250V, Max. 1A)
 - Error status relay output
 - Operation status relay output
 - Valve control

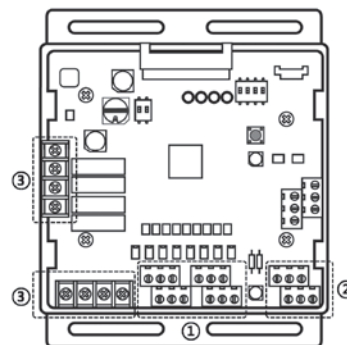

IO Module

ODU Capacity Control

Provides variable settings for ODU Capacity Control according to input method to reduce the power consumption. IO Module supports 2 types of input signal : Analog Inputs (0 ~ 10V, 10 steps) and contact signals (3 steps)

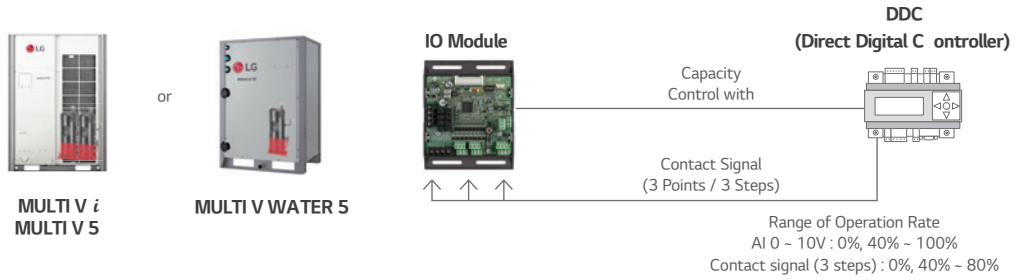

Low Noise Operation

To reduce noise level, control outdoor unit's fan speed by dry contact input.

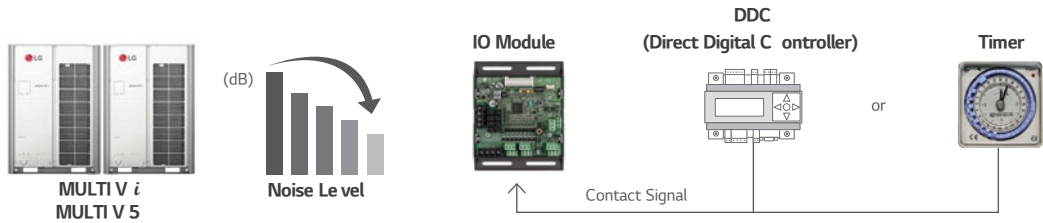

※ 8 HP (22.4kW) model, Sound power level can be changed by outdoor unit operation status and low noise operation input signal.

Refrigerant Leakage Detection with Pump-down

For safety, IO module closes refrigerant valve during Pump-down operation.

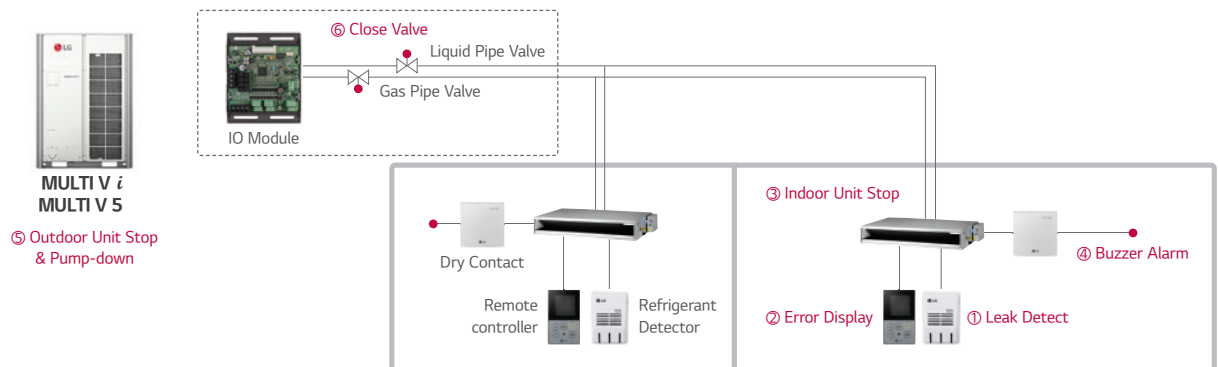

※ If the concentration of the refrigerant in the air exceeds 6,000 ppm more than 5 seconds, the function will be activated. (Refer to operation sequence which written in red, 1-6)

Variable Water Flow Control Kit

PWFCKN000 (MULTI V WATER 5)

Accessory for controlling the water flow.

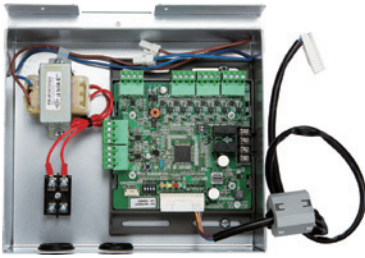

Features

Function

- Water pump or valve control (0 ~ 10V)
- Minimum output voltage setting available
- Operation, error output (AC 250V, Max. 1A)
- Dry contact input and analog output for demand control
- Digital output for operation, error status (AC 250V, Max. 1A)

Description

- Water flow consumption reduction
- Pump electricity consumption reduction
- Including IO Module (Dry contact input, Analog input / output, Digital output)
- : Using Dry contact and variable water flow control function simultaneously.

Installation Scene

- Flow Control Valve : Regulates the flow or pressure of a fluid, normally responding to signals generated by independent devices.
- Flow Meter : Measures mass flow rate of a fluid traveling through a tube.
(The mass flow rate is the mass of the fluid traveling past a fixed point per unit time.)
- Pressure Sensor : Measures the pressure.

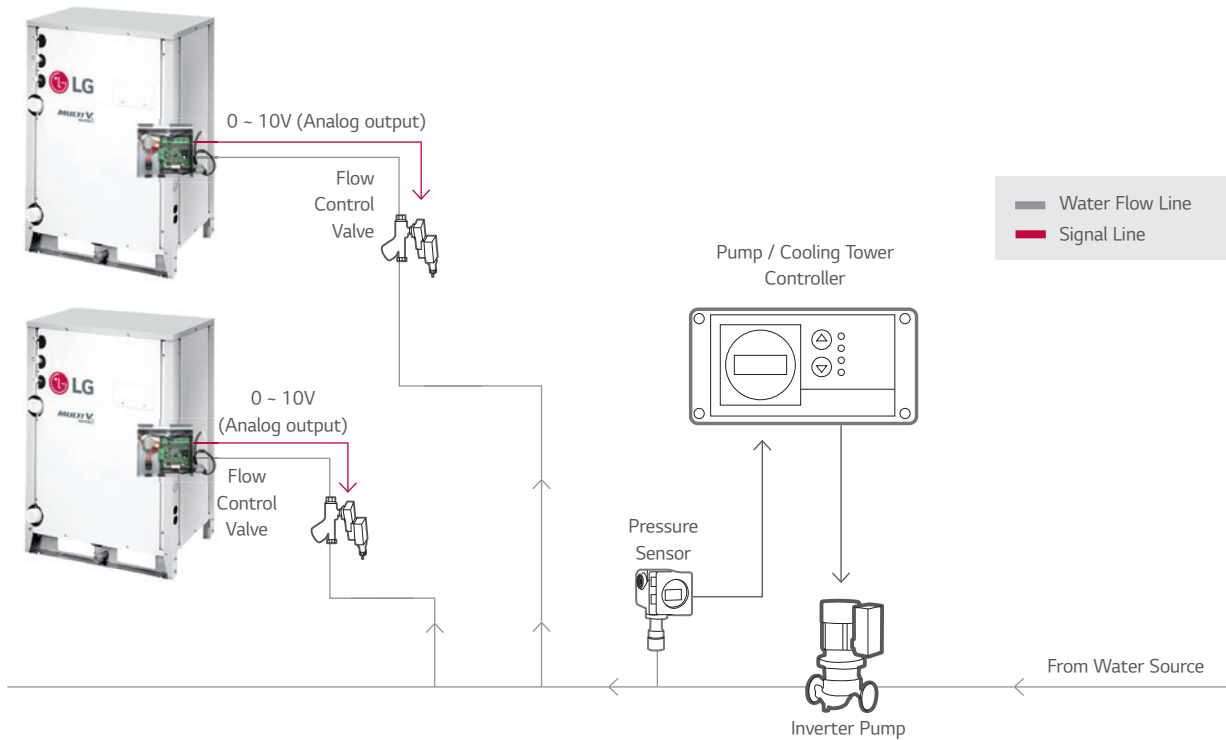

Low Ambient Kit

PRVC2

External integration module for cooling operation with -25 °C low ambient temperature.

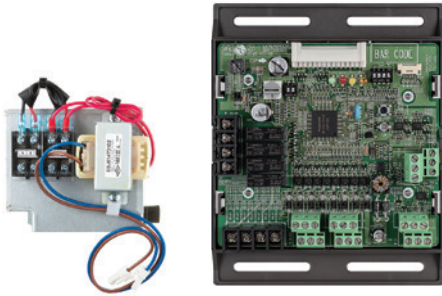

Features

Function

- -25 °C Low ambient cooling operation by Low ambient kit and hood with damper (Analog output 0 ~ 10V)
- Demand control
- Low noise operation
- Output outdoor or indoor unit operation status (AC 250V, Max. 1A)
- Output error status (AC 250V, Max. 1A)

Description

- Low ambient kit supports -25 °C cooling operation by making stable condensing pressure with reducing air flow rate from hood and damper control given 0 ~ 10V proportional to condensing pressure.
- Low ambient kit provides IO Module function.
- External snow hood and air damper are required for this item.
- Transformer and terminal block are included.

Models Applied

- MULTI V i
- MULTI V 5

Installation Scene

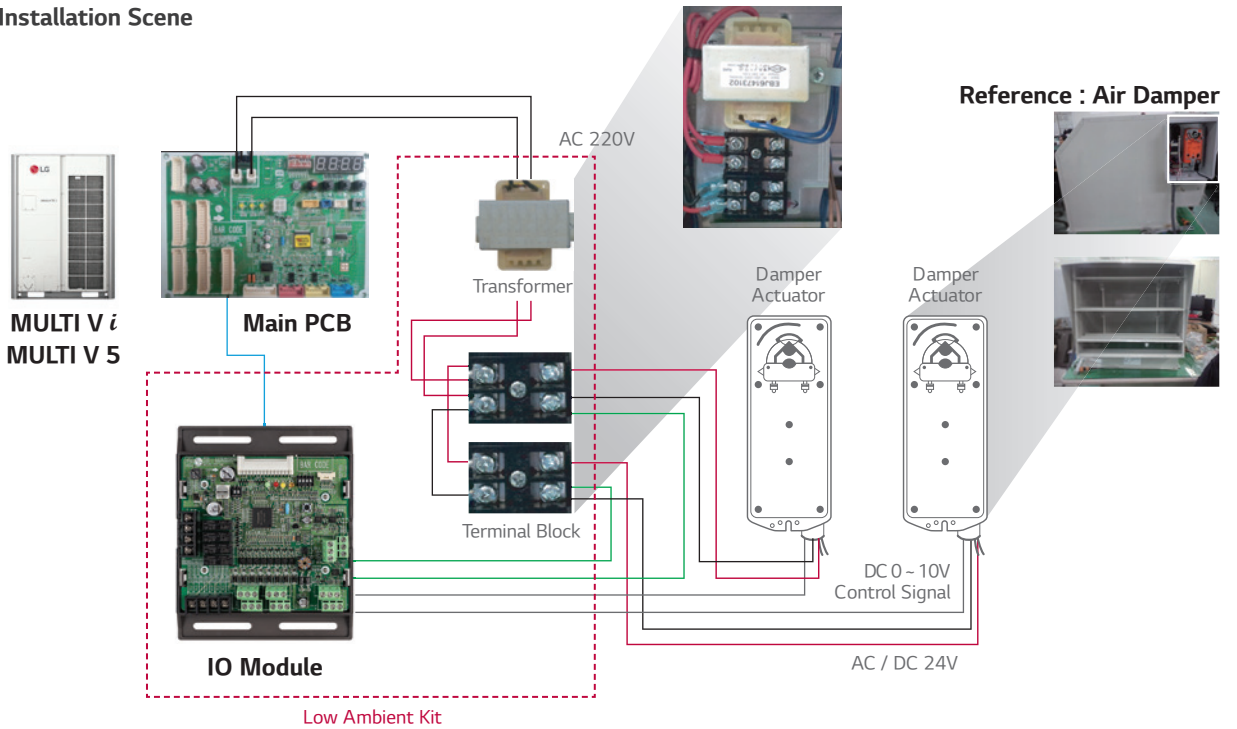

Note

1. Damper Actuator can accept only DC 24V power input.
2. Do not input AC power. Otherwise it will cause a serious damage.
3. The IO Module can control maximum three actuators.
4. Case of one valve, the slave signal connector must not use.
5. The power (AC / DC 24V) and signal (DC 0 ~ 10V) line is recommended by AWG22 (1/32 in, (0.644 mm), 0.016 Ω / ft (0.053 Ω / m)).

Cool / Heat Selector

PRDSBM

Cooling only, heating only, and fan mode can be selected.



Features

- Indoor unit mode control without central controller.
- Select operation mode : Cooling, Heating, Fan mode
- Mode lock for cooling & heating mixing error-proof during the change of season.

Models Applied

- MULTI V i
- MULTI V 5
- MULTI V IV
- MULTI V WATER S
- MULTI V WATER II
- MULTI V S
- MUL TI V PLUS II, MULTI V PLUS
- MULTI V WATER IV
- MULTI V WATER 5

Note : Cool / Heat Selector is not compatible for Multi V S R32.

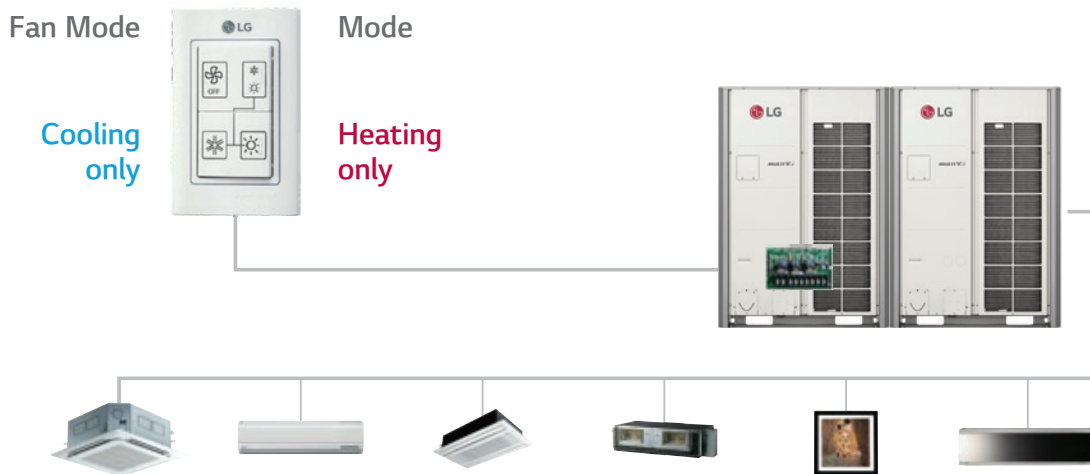

Installation Scene

<Outdoor Main PCB >

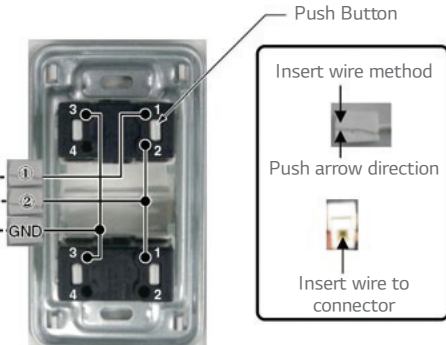

- Connect Terminals (1, 2, GND) on the back side of the outdoor dry contact to terminals (1, 2, GND) of outdoor as shown below.

Communication line length can be maximum 300m, use Communication line as thick 1.25mm.

----- Field wiring
 ——— Connected wiring

AHU Kit

A solution to connect LG's high efficiency system to the DX coil of an air handling unit for maximum energy savings.

COMMUNICATION KIT



PAHCMR000

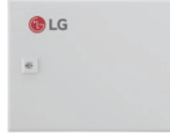

PAHCMS000

CONTROL KIT



PAHCNM000

EEV KIT



PRLK048A0
PRLK096A0

CONTROLLER MODULE

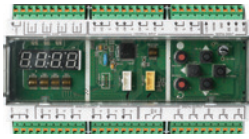

PAHCMM000

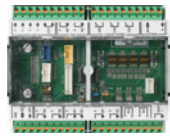

PAHCMC000



PRLK396A0

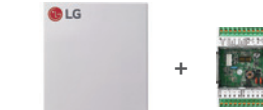

PRLK594A0

Specification

Control Application Kit

TYPE	MODEL	DIMENSIONS (MM)			POWER SUPPLY	IP RATING	DESCRIPTION
		W	H	D			
Communication Kit	PAHCMR000	300	300	155	1Ø, 220 – 240 V, 50 / 60 Hz	IP66	Return / Room air temperature control by DDC or LG individual / centralized controller.
	PAHCMS000	380	300	155	1Ø, 220 – 240 V, 50 / 60 Hz	IP66	Discharge air / Supply air temperature control by DDC or LG individual / centralized controller
Controller Module	PAHCMM000	162	90	61	DC 12V	IP20	Main Controller module
	PAHCMC000	108	90	61	DC 12V	IP20	Communication Controller module
Control Kit	PAHCNM000	500	500	210	1Ø, 220 – 240 V, 50 / 60 Hz		Various AHU control functions with multiple DX coils (Maximum connectable ODU is 3 units)

Expansion Application Kit

TYPE	MODEL	DIMENSIONS (MM)			PIPE DIAMETER (MM)	CAPACITY INDEX RANGE
		W	H	D	LIQUID	
EEV Kit	PRLK048A0	217	404	83	12.7	3.6 – 28 kW
	PRLK096A0	217	404	83	12.7	28.1 – 56 kW
	PRLK396A0	349.5	345.5	180	19.05	56.1 – 112 kW
	PRLK594A0	409.5	345.5	180	19.05	112.1 – 168 kW

Communication Kit

High Energy Efficiency

LG's DX AHU solutions' superior performance provides a highly efficient heat source system.

- High energy efficiency inverter system
- Large range of expansion application Kit : Max. 168 kW EEV Kit 1)
- Connected to various heat sources : MULTI V, MULTI V WATER, MULTI V S, SINGLE SPLIT

1) Maximum connectable EEV capacity for PAHCMR000, PAHCMC000 is 112 kW.

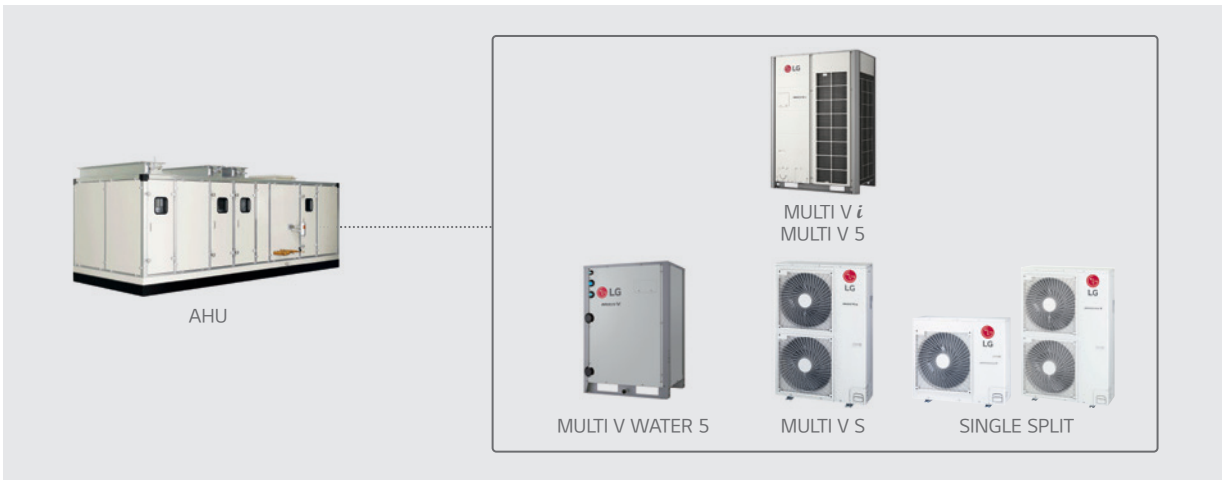

Diverse Options for Control

AHU communication kit can be connected to various control systems such as LG individual / central controller and DDC.¹⁾

It can be directly connected to DDC without separated controller, so DDC can receive product control and monitor information through contact signal or Modbus protocol.

- LG Individual / Central controller supported
 - LG controller stand alone or combination with DDC
- Direct wiring between DDC and AHU communication kit
 - Embedded Digital I / O and Analog Input
 - Modbus RTU protocol supported

1) DDC : Direct Digital Controller

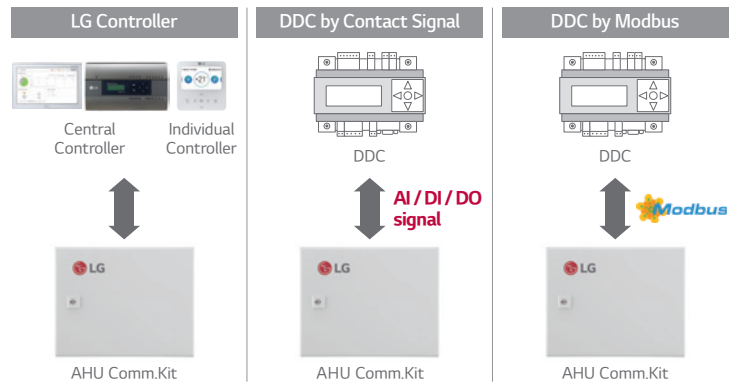

AHU Kit

Communication Kit

Expandable System Design

LG AHU system can be a suitable solution for various sites due to its application flexibility and wide range of line up with large capacity models. According to the required capacity, a single or multiple module combination is possible due to the AHU communication kit's modular design.

- Multiple module combination for large capacity AHU

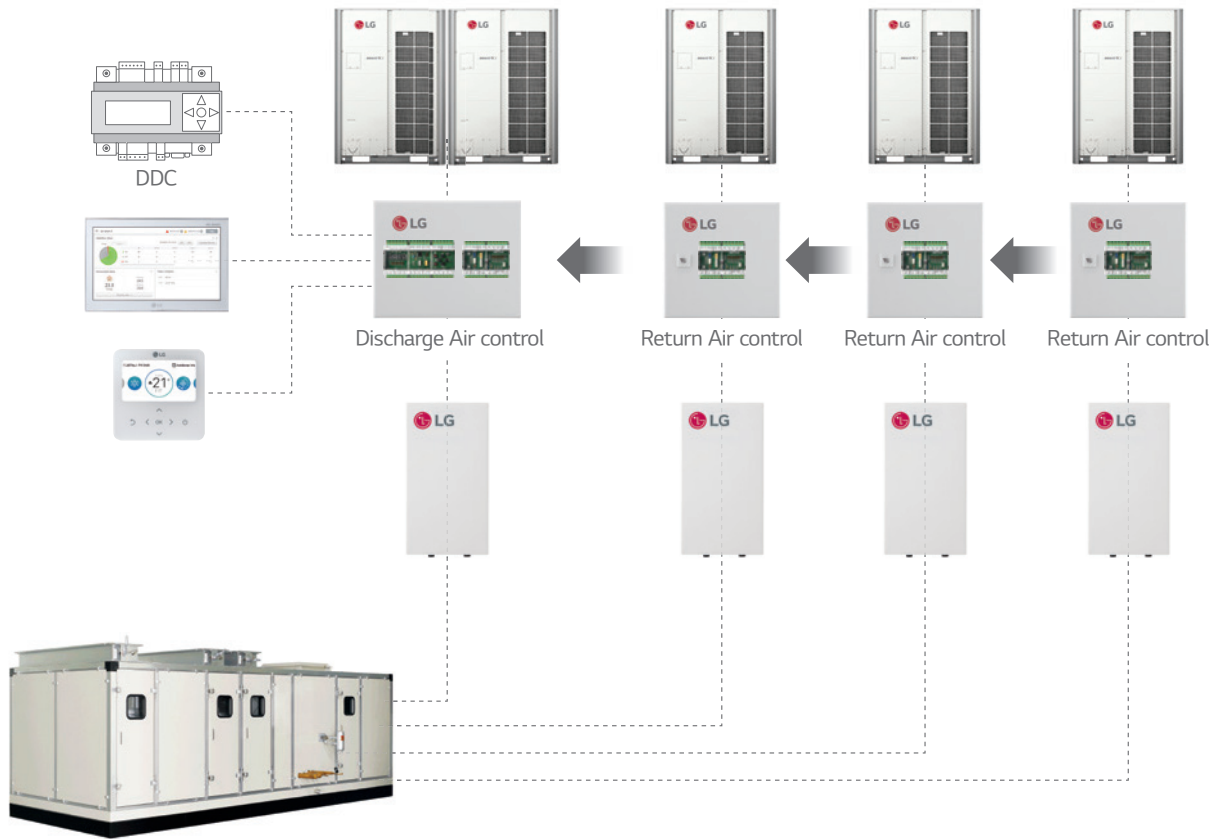

Communication Kit & Controller Module

Single Split Application

Single Split + Return / Room Air Temperature Control

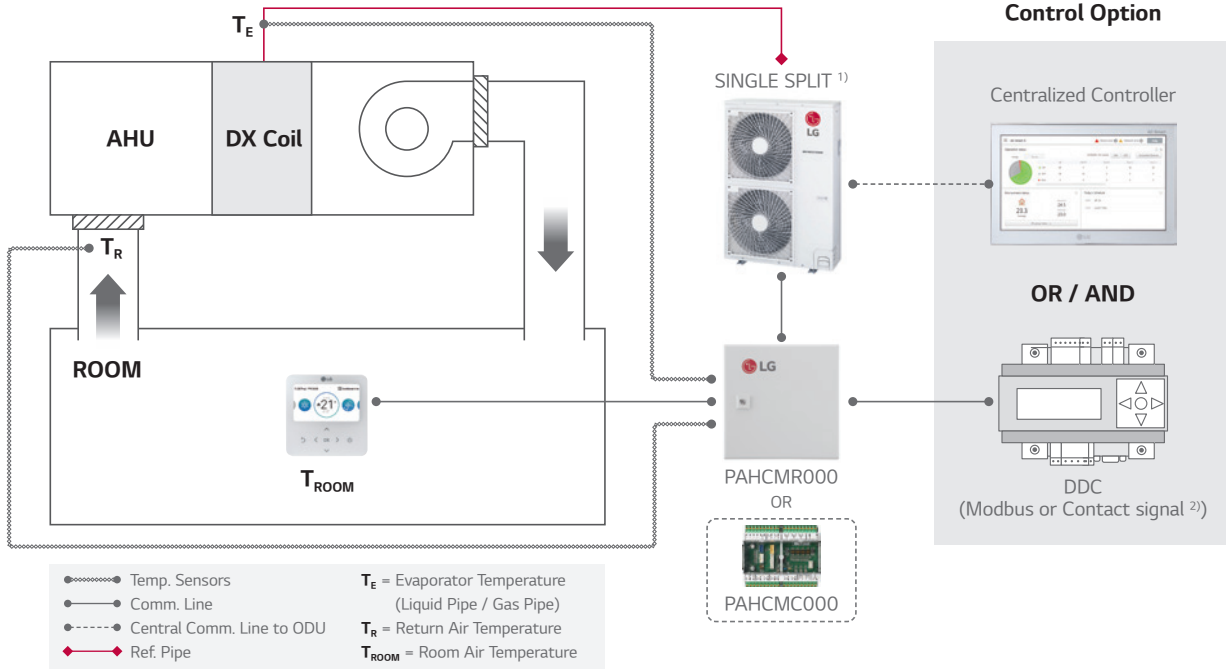

1) PI485 (PMNFP14A1) is required for centralized controller.

2) In case of applying DDC with contact signal, discharge air temperature should be measured and controlled by DDC.
 Note : For more detail, please refer to the PDB.

Single Split Application

Single Split + Discharge Air Temperature Control

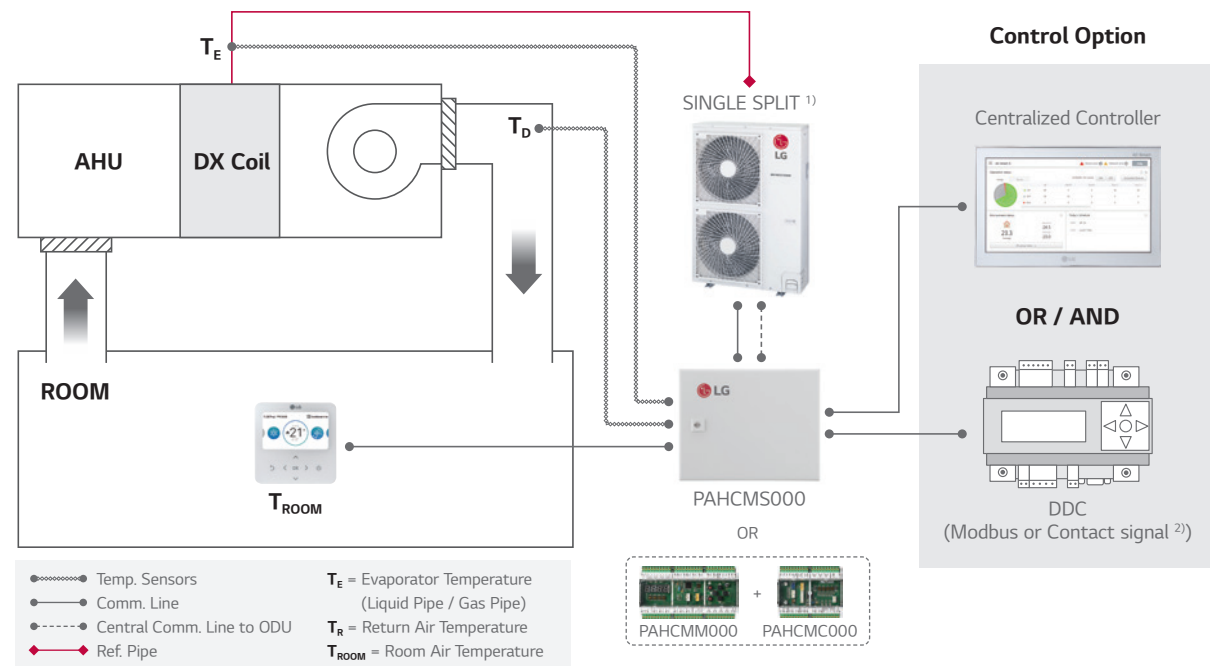

1) PI485 (PMNFP14A1) is required for centralized controller.

2) In case of applying DDC with contact signal, discharge air temperature should be measured and controlled by DDC.
 Note : For more detail, please refer to the PDB.

AHU Kit

Communication Kit & Controller Module

MULTI V Application

MULTI V + EEV Kit + IDU + Return / Room Air Temperature Control

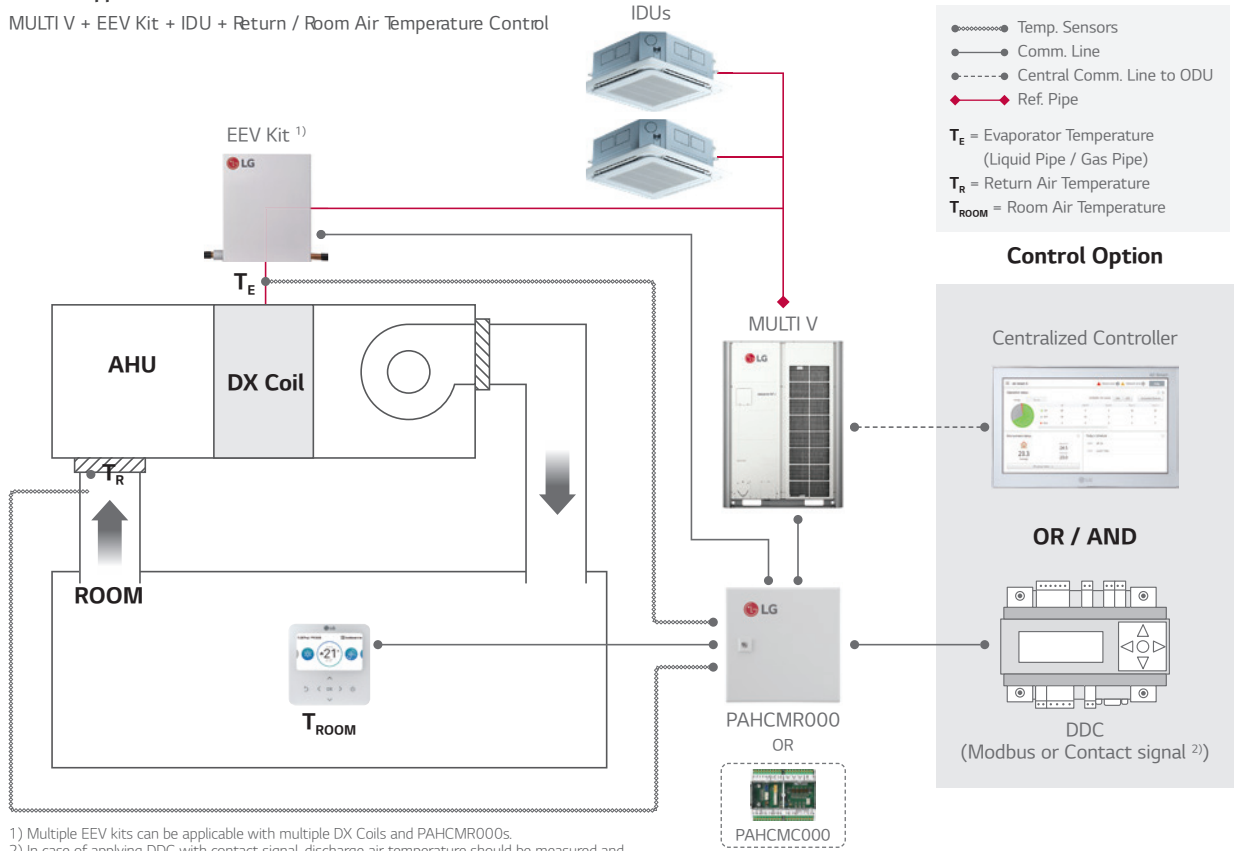

1) Multiple EEV kits can be applicable with multiple DX Coils and PAHCMR000s.
 2) In case of applying DDC with contact signal, discharge air temperature should be measured and controlled by DDC.
 Note : For more detail, please refer to the PDB.

MULTI V Application

MULTI V + EEV Kit + Discharge Air Temperature Control

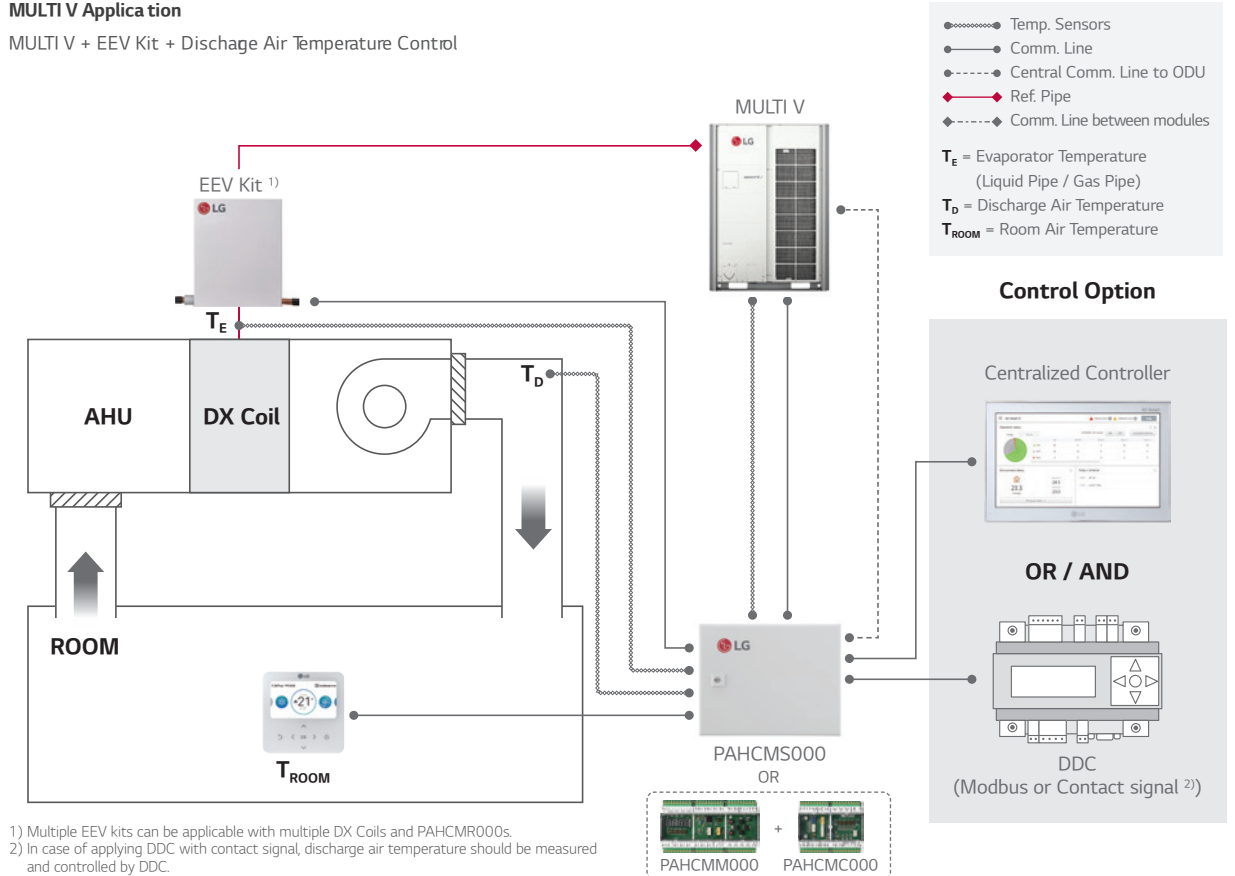

1) Multiple EEV kits can be applicable with multiple DX Coils and PAHCMR000s.
 2) In case of applying DDC with contact signal, discharge air temperature should be measured and controlled by DDC.
 Note : For more detail, please refer to the PDB.

Communication Kit Function

Communication with DDC via Contact Signal

FUNCTION LIST	PAHCMR000 (PAHCMC000)	PAHCMS000 (PAHCMM000 + PAHCMC000)	TYPE	NOTE
Operation On / Off	On / Off	On / Off	Digital Input (Non Voltage)	-
Operation Mode	Cooling / Heating	Cooling / Heating	Digital Input (Non Voltage)	Available operation mode can vary depending on the settings of Communication Kit
Return (Room) Air Temperature ²⁾	16 ~ 30 °C	-	Analog Input (DC 0 ~ 10 V / 20mA)	-
Control ¹⁾ Discharge Air Temperature ²⁾	-	-	-	Discharge air temperature should be controller directly by DDC using 'ODU Capacity Control'
Fan Speed ³⁾	-	High / Middle / Low	Digital Input (Non Voltage)	-
Forced Thermal	On / Off	-	Digital Input (Non Voltage)	-
ODU Capacity	-	10 ~ 100%	Analog Input (DC 0 ~ 10 V / 20mA)	-
Emergency Stop	-	Stop / Normal	Digital Input (Non Voltage)	-
Monitor Operation	On / Off	On / Off	Digital Output (Max. : DC 30 V / 1 A, AC 250V / 1 A)	For PACHMR000, dip sw1-3 DO Type should be set 'Off' (Status), In this case, 'fan speed' cannot be monitored by DO ports
Operation Mode	-	-	-	It needs to be checked through control signal
Fan Speed	High / Middle / Low	High / Middle / Low	Digital Output (Max. : DC 30 V / 1 A, AC 250V / 1 A)	For PACHMR000, dip sw1-3 DO Type should be set 'On' (Fan Mode) In this case, 'On / Off, defrost, error Status' cannot be monitored by DO ports
Defrost Operation	Defrost / Normal	Defrost / Normal	Digital Output (Max. : DC 30 V / 1 A, AC 250V / 1 A)	For PACHMR000, dip sw1-3 DO type should be set 'OFF' (Status), In this case, 'fan speed' cannot be monitored by DO ports
Error Alarm	Error / Normal	Error / Normal	Digital Output, Relay C contact (Max. : DC 30 V / 1 A, AC 250V / 1 A)	-
Compressor On / Off	-	On / Off	Digital Output, (Max. : DC 30 V / 1 A, AC 250V / 1 A)	-

1) Control functions for LG individual and central controller are not available in case of using together with DDC via contact signal.

2) The range of temp. is differ depending on the type of the controller.

3) To control fan speeds, DO port of the fan speed status should be connected to the fan control panel.

Note : For more detail information, please refer to the product data book.

Communication with DDC via Modbus protocol

FUNCTION LIST	PAHCMR000 (PAHCMC000)	PAHCMS000 (PAHCMM000 + PAHCMC000)	NOTE
Operation On / Off	On / Off	On / Off	
Operation Mode	Cooling / Heating / Fan	Cooling / Heating / Fan	
Return (Room) Air Temperature	16 ~ 30 °C	-	
Control ¹⁾ Discharge Air Temperature ²⁾	-	○	Dip SW1-2 Discharge Temp. Control Type should be set 'On' Standard II : 16 ~ 30 °C Standard III ⁴⁾ : 12 ~ 50 °C
Fan Speed ³⁾	High / Middle / Low	-	
Forced Thermal On / Off	-	-	
ODU Capacity Control ²⁾	-	10 ~ 100%	Dip SW1-2 Discharge Temp. Control Type should be set 'On'
Emergency Stop	-	-	
Monitor Operation	On / Off	On / Off	
Operation Mode	Cooling / Heating / Fan	Cooling / Heating / Fan	
Return (Room) Air Temperature	○	-	Corresponding air temperature sensor connected to AHU Comm.Kit is required
Discharge Air Temperature	-	○	
Fan Speed	High / Middle / Low	High / Middle / Low	
Defrost Operation	Defrost / Normal	Defrost / Normal	
Error Alarm	Error / Normal, Error code	Error / Normal, Error code	
Compressor On / Off	On / Off	On / Off	

※ ○ : Applied, - : Not Applied

1) Control functions for LG individual and central controller are not available in case of using together with DDC via contact signal.

2) In case of PAHCMS000, control type between "Discharge Air Temperature" and "ODU Capacity Control" is selectable.

3) To control fan speeds, DO port of the fan speed status should be connected to the fan control panel.

4) Standard III wired remote controller after version 2.10.5a.

Note : For the Modbus memory map and more detail information, please refer to the product data book.

AHU Kit

Communication Kit Function

With LG Control System (Individual & Centralized Controller)

FUNCTION LIST		PAHCMR000 (PAHCMC000)	PAHCMS000 (PAHCMM000 + PAHCMC000)	NOTE
Control ¹⁾	Operation On / Off	On / Off	On / Off	-
	Operation Mode	Cooling / Heating / Fan	Cooling / Heating / Fan	Available operation mode can vary depending on the settings of Communication Kit
	Return (Room) Air Temperature ²⁾	16 ~ 30 °C	-	-
	Discharge Air Temperature ²⁾	-	○	Standard II : 16 ~ 30 °C Standard III ⁴⁾ : 12 ~ 50 °C Central Controllers : 12 ~ 50 °C
	Fan Speed ³⁾	High / Mid / Low	High / Mid / Low	To control the AHU fan, dip switch 1-3 'DO type' should be set 'On (Fan Speed)' (PAHCMR000)
Monitor	Operation	On / Off	On / Off	-
	Operation Mode	Cooling / Heating / Fan	Cooling / Heating / Fan	-
	Return (Room) Air Temperature	○	-	-
	Discharge Air Temperature	-	○	Standard II : 11 ~ 39.5 °C Standard III ⁴⁾ : 0 ~ 100.0 °C Central : -50.0 ~ 100.0 °C
	Fan Speed	High / Middle / Low	High / Middle / Low	-
	Defrost Operation	On / Off	On / Off	Only with Individual Controller
	Error Alarm	Error Code	Error Code	Error code will be displayed on the screen
	Compressor On / Off	On / Off	On / Off	Only with Individual Controller

※ ○ : Applied, - : Not Applied

1) Control functions for LG individual and central controller are not available in case of using together with DDC via contact signal.





2) The range of setting temperature is different depending on the type of the controllers. And operation may differ from setting range.

3) To control fan speeds, DO port of the fan speed status should be connected to the fan control panel.

4) Standard III wired remote controller after version 2.10.5a.

Note : For more detail information, please refer to the product data book.

Compatibility with LG HVAC Controllers

CONTROLLER	INDIVIDUAL CONTROLLER			CENTRALIZED CONTROLLER					PDI
	PREMIUM	STANDARD III	STANDARD II	AC EZ	AC EZ TOUCH	AC SMART 5	ACP 5	AC MANAGER 5 ¹⁾	PREMIUM STANDARD
									
Model no.	PREMTA000 PREMTA000A PREMTA000B	PREMTB100 PREMTBB10	PREMTB001	PQCSZ250S0	PACEZA000	PACS5A000	PACP5A000	PACM5A000	PQNUD1S40 PPWRDB000
PAHCMR000	○	○	○	○	○	○	○	○	○
PAHCMS000	-	○	○	-	-	○	○	○	-

※ ○ : Applied, - : Not Applied

1) AC Manager 5 is an integrator, so the installation with AC Smart 5 or ACP 5 is required.

Note : 1. Dry contact for indoor unit (PDRYCB000 / 400 / 300 / 500) is not applied.

2. For more details, please refer to the product data book.

Outdoor Unit Compatibility

For Small Size Application (~ 15kW) - Single Split

TYPE	MODEL	UUA1 (2.5 - 5.0 kW) 1)	UUB1 (5.0 - 8.0 kW) 1)	UUC1 (7.1 - 10.0 kW) 1)	UUD1 / UUD3 (10.0 - 15.0 kW) 1)
Communication Kit (Controller Module)	PAHCMR000 (PAHCMC000)	-	○	○	○
	PAHCMS000 (PAHCMM000 + PAHCMC000)	-	○	○	○
Control Kit	PAHCNM000	-	-	-	-

1) When connecting to Single Split outdoor unit, please check the compatibility to the regional sales office.

For Medium-Large Size Application (~ 672 kW) - MULTI V

TYPE	MODEL	MULTI V					MULTI V WATER		
		i	S	IV	III	S	S	IV	II
Communication Kit (Controller Module)	PAHCMR000 (PAHCMC000)	○	○	○	○	○	○	○	○
	PAHCMS000 (PAHCMM000 + PAHCMC000)	○	○	○	○	○	○	○	○
Control Kit	PAHCNM000	○	○	○	○	○	○	○	○

EEV Kit Compatibility

EEV KIT MODEL	CAPACITY INDEX (kW)		AHU APPLICATION KITS (MAXIMUM CONNECTABLE EEV KITS)			CONNECTION BY ODU SYSTEM		
	MIN.	MAX.	PAHCMR000 (PAHCMC000)	PAHCMS000 (PAHCMM000 + PAHCMC000)	PAHCNM000	MULTI V		SINGLE SPLIT
						HEAT PUMP	HEAT RECOVERY	
PRLK048A0	3.6	28	○ (1)	○ (1)	○ (6)	○	○	-
PRLK096A0	28.1	56	○ (1)	○ (1)	○ (6)	○	○ (Max. 33.7 kW)	-
PRLK396A0	56.1	112	○ (1)	○ (1)	○ (6)	○	-	-
PRLK594A0	112.1	168	-	○ (1)	○ (3)	○	-	-

※ ○ : Applied, - : Not applied

Note 1. Table of the outdoor unit compatibility is based on European regional model.

2. When connecting outdoor units in other areas, please check whether they are compatible or not.

3. Expansion application kit compatibility is based on capacity index of the system, it may changed according to system design condition.

AHU Kit

Control Kit

Field Supplied Item

LIST	REQUIRED SPECIFICATION	APPLY LOCATION
Temperature / Humidity Sensor	- Power : AC 24 V - Output signal : DC 0 ~ 10 V - Temperature range : -40 °C ~ 70 °C - Humidity range : 0 ~ 95 % RH	Supply air duct, Return air duct, Outdoor air duct
Temperature Sensor	- Power : AC 24 V - Output signal : DC 0 ~ 10 V - Temperature range : -50 °C ~ 50 °C	Supply air duct, Return air duct, Mixed air duct
Damper Actuator	- Power : AC 24 V - Input / output signal : DC 0 ~ 10 V - Torque : 15 N·m - Operation time : 150 s - Rotation Angle : 90°	Outdoor air damper, Exhaust air damper, Mixed damper
Filter Differential Pressure Sensor	- Power : AC 24 V - Output signal : DC 0 ~ 10 V - Range: 0 ~ 1,000 Pa - Switch type : Relay open / close	Filter
Static Pressure Sensor	- Power : AC 24 V - Output signal : DC 0 ~ 10 V - Range : 0 ~ 1,000 Pa	Supply air duct
CO ₂ Sensor	- Power : AC 24 V - Output signal : DC 0 ~ 10 V - Range : 0 ~ 2,000 ppm	Return air duct
Smoke Detector	- Power : AC 24 V - Type : Contact	Return air duct

Various Control with Control Kit – Multiple MULTI V + EEV Kits

Field Supplied Item

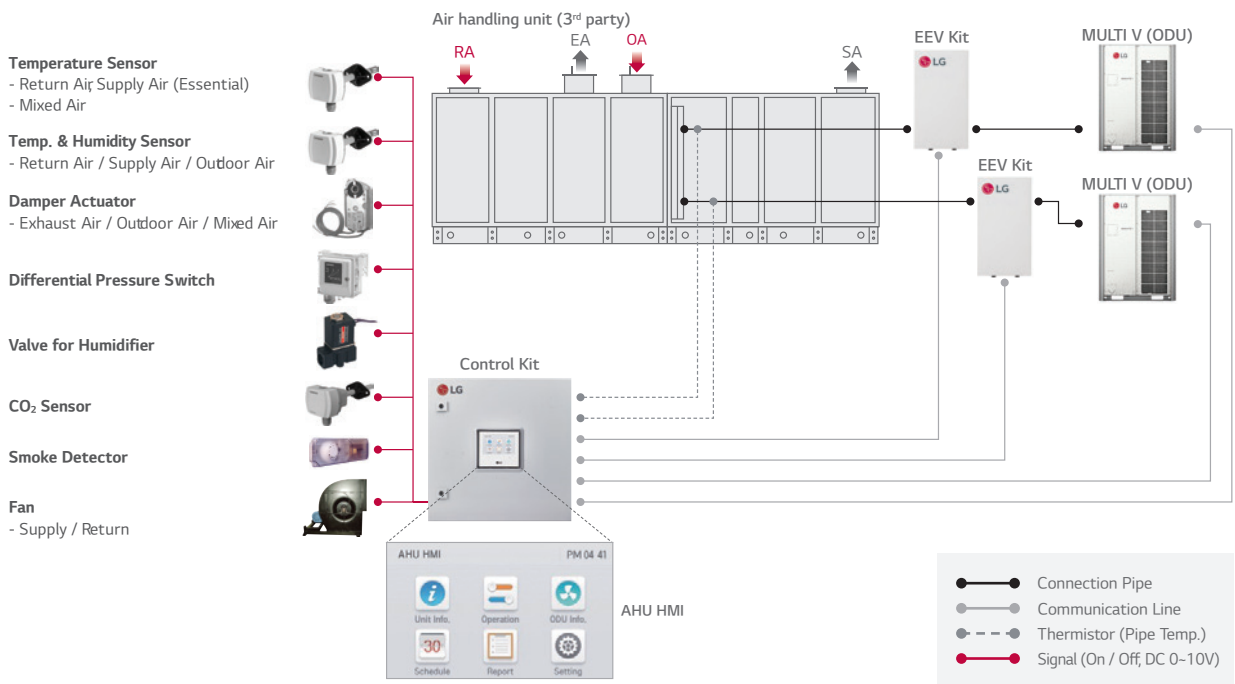

Water Communication Module

PAHCMW000

This module is intended to connect 3rd party plate heat exchanger to LG outdoor unit with the ability to control water temperature from 3rd party DDC or LG remote controller.



Overview

Interlocking with 3rd parties can make various solution with LG Multi V outdoor unit.

- 1. EEV
- 2. Solenoid Valve (NC)
- 3. Non-Return Valve
- 4. FS : Flow Switch
- 5. TT : DHW Temperature Transmitter

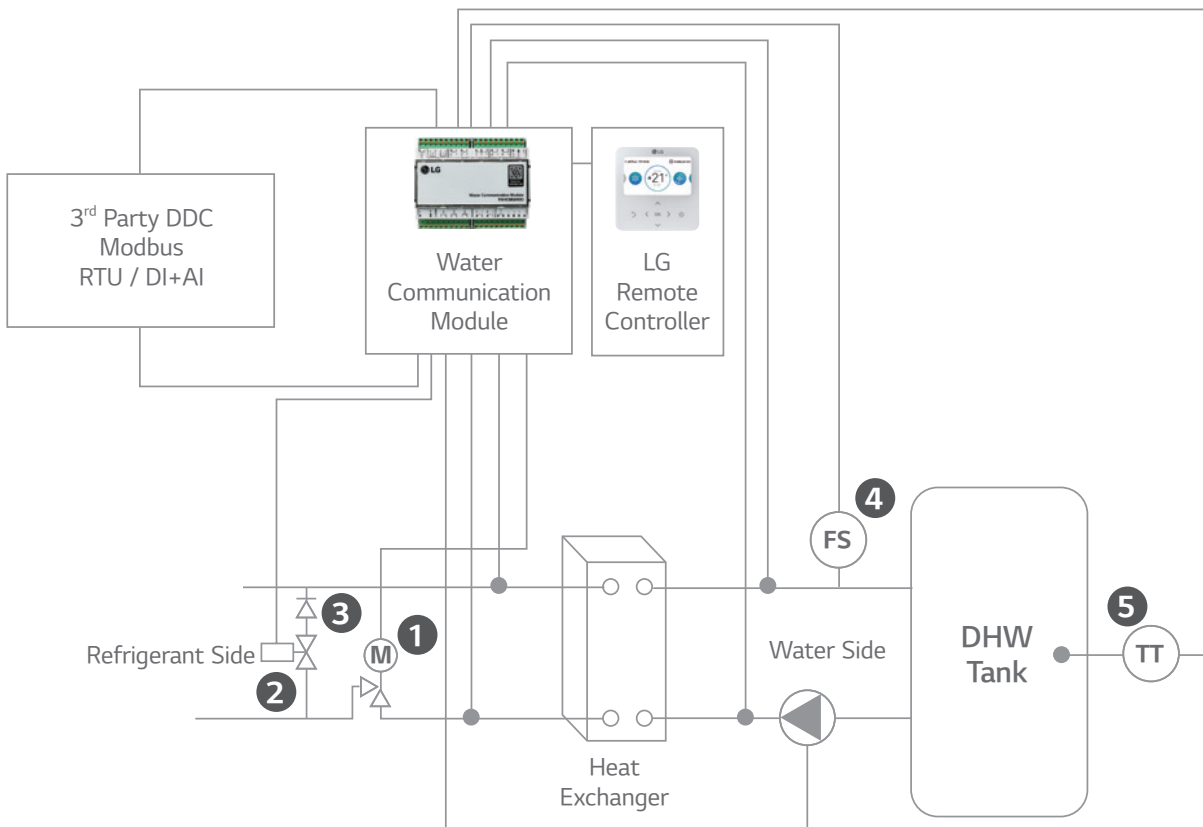

• 3rd party solenoid, non-return valve, heat exchanger, flow switch and DHW temperature transmitter (Optional) must be purchased separately. (Field supplied items)

Water Communication Module

Features & Benefits

Interlocking with 3rd parties can make various solution with LG MULTI V outdoor unit.

Interlocking with 3rd Party Equipment

CONTENTS	CONNECTION PORT		FUNCTION
RS485	CH1 (A+ / B-)	Module Comm. Port	Communication Port Modbus
	CH2 (A+ / B-)	IDU Comm. Port	Communication with Multi V Outdoor
UNIVERSAL INPUT (Cooling / Heating Setting)	UI1	Flow Switch	Flow Switch Input by 3rd party
	UI2	0 ~ 10V Set Temp.	Target Temp. Setting
	UI3	Cooling Thermostat Signal	Thermostat Cooling Signal
	UI4	Heating Thermostat Signal	Thermostat Heating Signal
UNIVERSAL INPUT (DHW Only)	UI1	Flow Switch	Flow Switch Input by 3rd party
	UI2	0-10V Set Temp.	Target Temp. Setting
	UI3	DHW Temperature Transmitter 0 ~ 10V	Measured Water Temp. Input by 3rd party 0 ~ 10 V sensor
	UI4	DHW Thermostat Signal	DHW Heating Signal
NTC	RI1	Water Inlet Sensor	PHEX Water Inlet Sensor
	RI2	Water Outlet Sensor	PHEX Water Outlet Sensor
REMO	+12V / SIG / GND	LG Remote Controller	-
SINGLE	Reserved	-	-
DIGITAL OUTPUT	DO1	Defrost / Mode	Output for defrost signal and / or cool mode
	DO2	Pump	Output signal for pump on / off
	DO3	Bypass	Output signal for PHEX Bypass Valve
NTC	RI3	Thermistor Pipe In	PHEX Ref. Inlet Pipe Sensor
	RI4	Thermistor Pipe Out	PHEX Ref. Outlet Pipe Sensor
EEV	+12V / 1 / 2 / 3 / 4	Expansion Valve	EEV Control

Compatibility & Accessory

EEV (LG MODEL)

MODEL	CAPACITY (kW)		PAHCMW000
	MIN.	MAX.	
PAEEVC000	3.6	28	HP / HR
PRLK048A0	3.6	28	HP / HR
PRLK096A0	28.1	56	HP

Note :
Water communication module can accept plate heat exchangers from 3, 6 to 112 kW for combination with Multi V Outdoor units.

LG Controllers

CONTROLLER	INDIVIDUAL CONTROLLER	CENTRALIZED CONTROLLER		DRY CONTACT
	HEATING STANDARD III	AC EZ TOUCH	AC SMART 5	
	PREMTW101	PACEZA000	PACS5A000	PDRYCB000

Specification for Field supply item

- The 3rd party can select the for best usable version

Solenoid valve for Bypass

CAPACITY (kW)		EEV TYPE	SYSTEM	KV VALUE OF SOLENOID AND NON-RETURN VALVE	PIPE SIZE
MIN.	MAX.				
3.6	28	PAEEVC000	HP / HR	0.95	3 / 8" / 9.52mm
		PRLK048A0			
28	56	PRLK096A0	HP	1.9	1 / 2" / 12.7mm

Flow switch

- The nominal flow and cut of flow can be calculated using the values below.

CONTROLLER	NOMINAL FLOW	FLOW SWITCH CUT OFF
L / min*kW	3.29	1.23

* Example : ODU nominal Cooling Capacity 28 kW, 28 x 3.29 = 92.12 L / min. nominal flow, 28 x 1.23 = 34.44 L / min. flow switch cut off

Water Communication Module

Installation Scene with Contact Connection

Contact signal + Heating / Cooling Setting

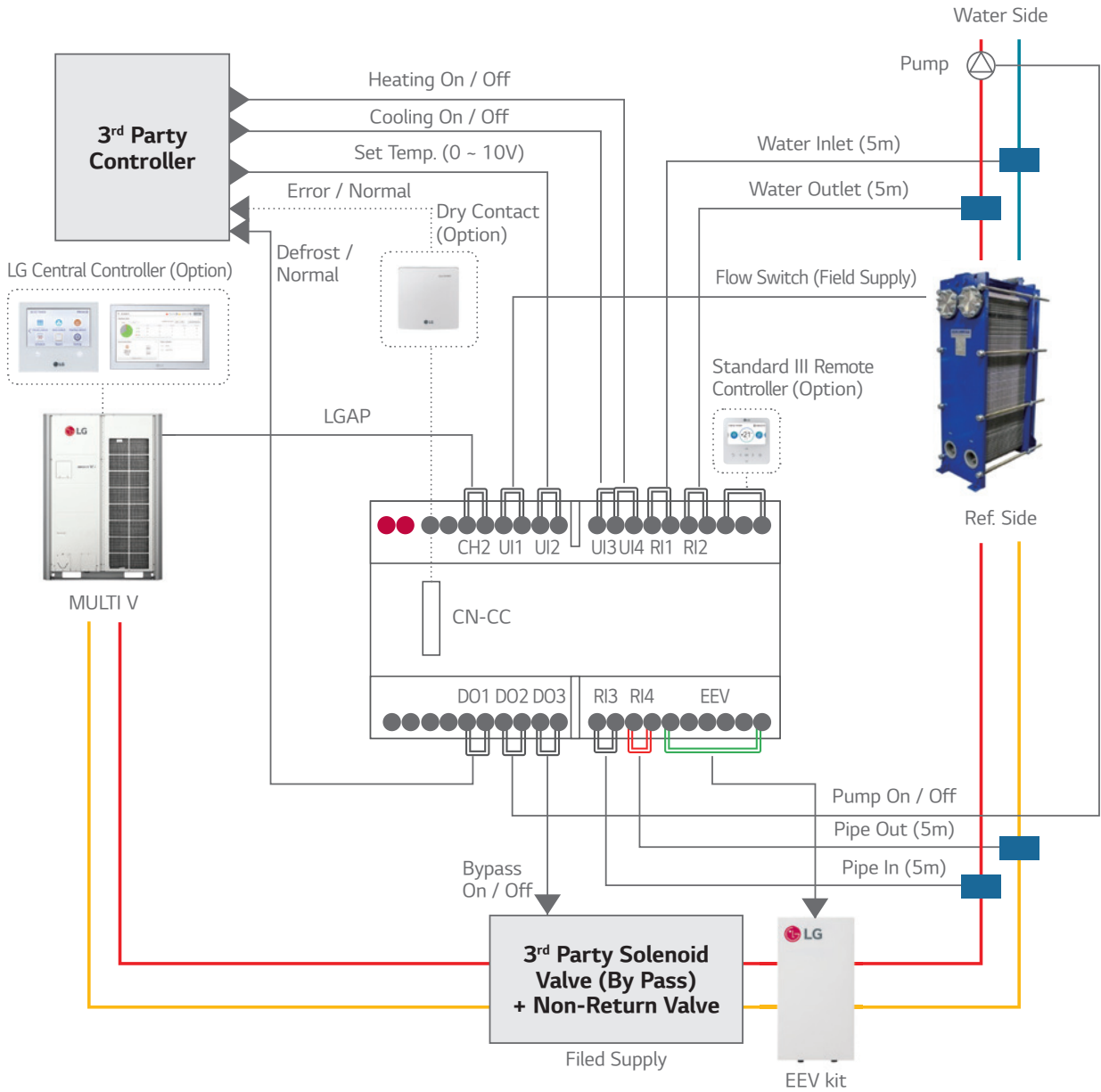

Installation Scene with Modbus / LG Control (Optional) Connection

Modbus + DHW Only Setting

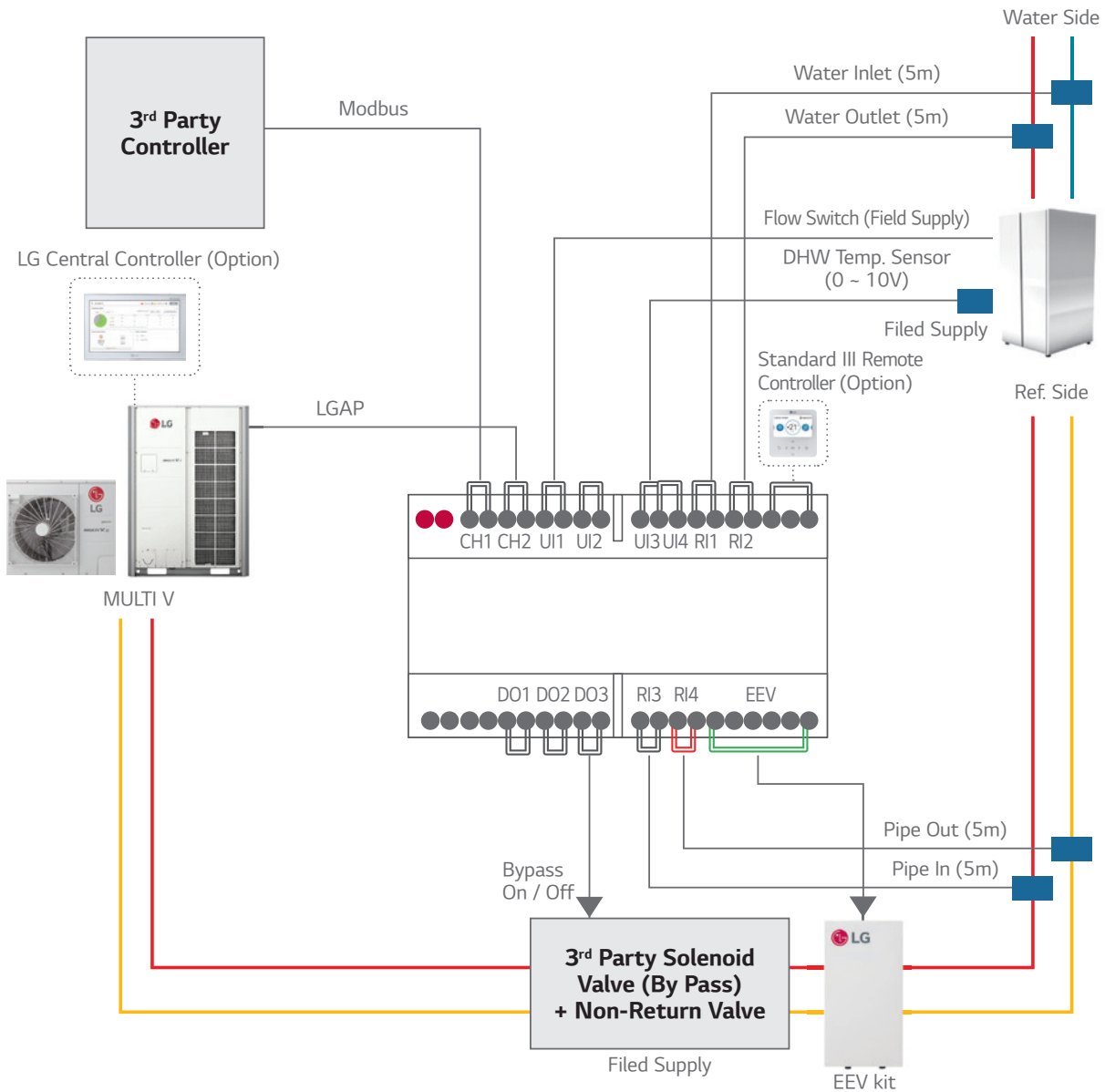

Water Communication Module

Installation Scene with Modbus / LG Control (Optional) Connection

Modbus + Heating / Cooling Setting

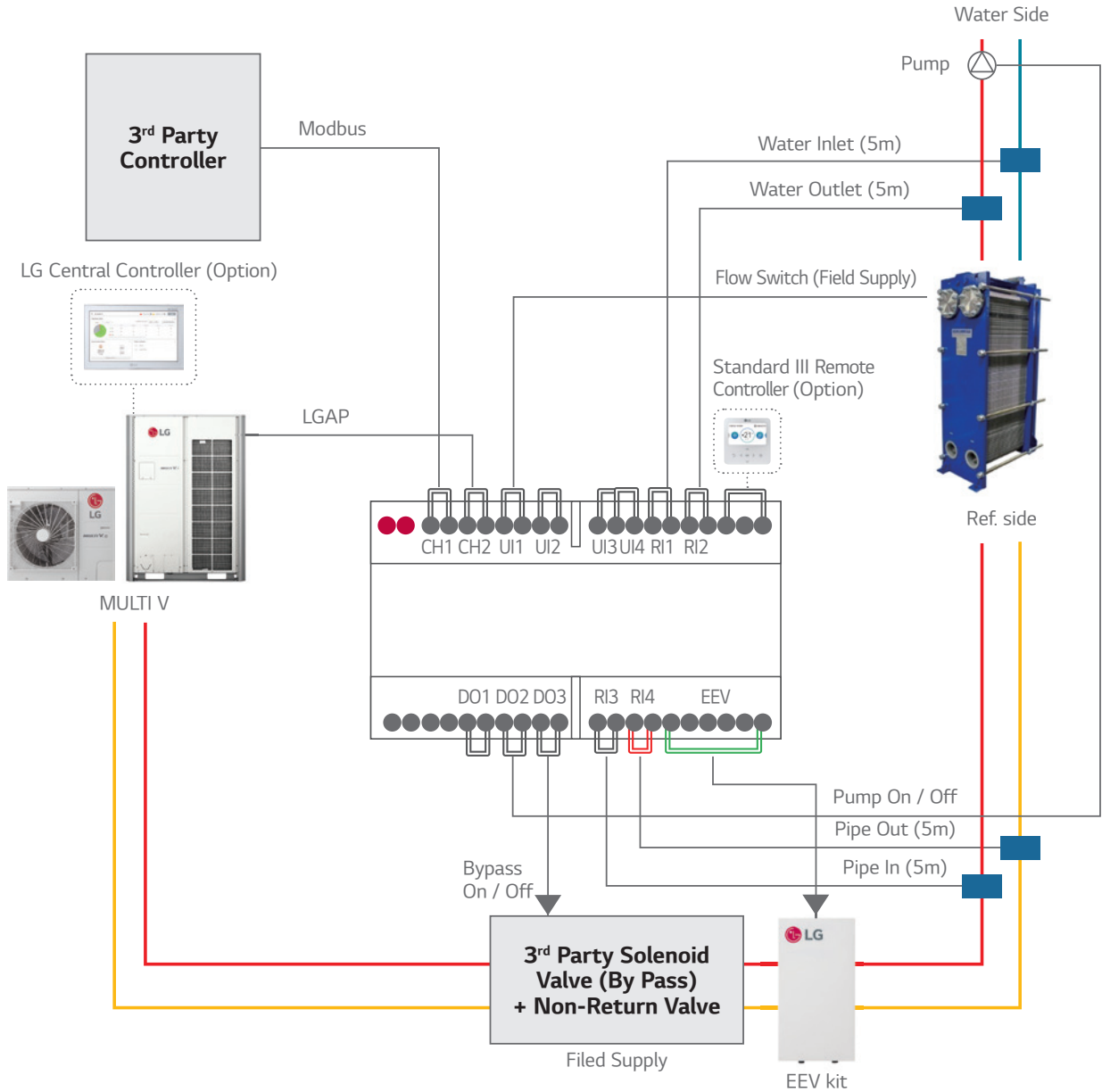



Hotel Control Solution



Guest Room

Air conditioner automatically switches off when guests depart

Integrated control of air conditioner with the hotel room controller

Air conditioner can be controlled with existing hotel thermostat

Prioritizes guest safety with refrigerant leak detection

Reception

Air conditioner control in conjunction with check-in or check out

Public Areas

Centralized management of the public areas

Design Proposal

GUEST ROOM				LOBBY
<p>The air conditioner automatically turns off when guests leave</p>	<p>Integrated control of air conditioner with the hotel room controller</p>	<p>Control with existing hotel thermostat</p>	<p>Guest safety is the first priority</p>	<p>Air conditioner control in conjunction with check-in or check out</p>
<p>PDRYCB400 2 contact point</p> <p>Input</p> <ul style="list-style-type: none"> • Operation On / Off <p>Output</p> <ul style="list-style-type: none"> • Operation On / Off status • Error alarm 	<p>PDRYCB500 / PDRYCB510 (w/o case)</p> <p>Function</p> <ul style="list-style-type: none"> • Operation • Indoor temperature • Error alarm • Set run mode • Set temperature • Set fan speed 	<p>PDRYCB320 8 contact point</p> <p>Input</p> <ul style="list-style-type: none"> • Universal Input • Operation On / Off • Thermo On / Off • Operation mode (Fan / Heat / Cool) • Fan speed (Low / Middle / High) <p>Output</p> <ul style="list-style-type: none"> • Operation On / Off status • Error alarm 	<p>PRLDNV50 Refrigerant leakage detector</p> <ul style="list-style-type: none"> • 6,000ppm <p>PREMTB100 Wired remote controller</p> <ul style="list-style-type: none"> • 4.3 inch color LCD • Touch button 	<p>PACS5A000 AC Smart 5</p> <ul style="list-style-type: none"> • BMS Integration (BACnet IP, Modbus TCP) <p>PACP5A000 ACP 5</p> <ul style="list-style-type: none"> • BMS Integration (BACnet IP, Modbus TCP)

Shopping Mall Control Solution



Retail

Proportionally distribute and manage the power consumption by tenants

Real-time system issue detection and alarms

Maintenance Office

Reduces energy by checking operational trends

Atrium

Integrated management of AHU applied to large spaces

Chiller and VRF integrated control

Design Proposal

RETAIL		MAINTENANCE OFFICE	ATRIUM	
<p>Proportionally distribute and manage power consumption by the tenant</p>	<p>Fast problem detection and alarms</p>	<p>Reduces energy by checking operational trends</p>	<p>Integrated management of AHU applied to large spaces</p>	<p>Chiller and VRF integrated control</p>
<p>PPWRDB000 PDI Standard (2 ports) • Max. 128 IDU</p>	<p>PACSSA000 AC Smart 5 • BMS Integration (BACnet IP, Modbus TCP)</p>	<p>PAHCMR000 AHU Comm.Kit • Return air</p>	<p>PACPSA000 ACP 5</p>	<p>PACSSA000 AC Smart 5</p>
<p>PQNUD1S40 PDI Premium (8 ports) • Max. 128 IDU</p>	<p>PACP5A000 ACP 5 • BMS Integration (BACnet IP, Modbus TCP)</p>	<p>PAHCMS000 AHU Comm.Kit • Discharge air</p>		

Hospital Control Solution



Hospital Ward

Proper airflow management for patients

Monitor the comfort level for each hospital ward

Control fan speed and air volume







Service Zone

Energy savings based on flexible scheduling

Lobby

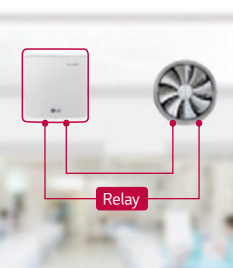
Centralized management of AHU for large spaces

Design Proposal

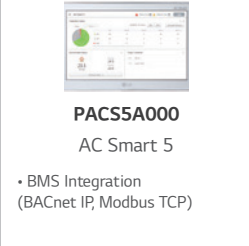
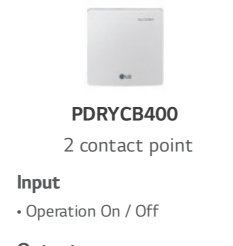
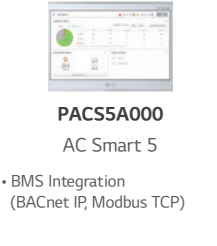
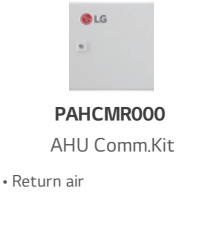
HOSPITAL WARD			SERVICE ZONE	LOBBY
Proper airflow management for patients	Monitor the comfort level for each hospital ward	External device interlock control	Energy savings based on flexible scheduling	Centralized management of AHU for large space
				
PTV5MA0 Human detection sensor	PAC55A000 AC Smart 5 • BMS Integration (BACnet IP, Modbus TCP)	PDRYCB400 2 contact point	PAC55A000 AC Smart 5 • BMS Integration (BACnet IP, Modbus TCP)	PAHCMR000 AHU Comm.Kit • Return air
				
PREMTB100 Wired remote controller • 4.3 inch color LCD • Touch button	PAC55A000 ACP 5 • BMS Integration (BACnet IP, Modbus TCP)	Input • Operation On / Off Output • Operation On / Off status • Error alarm	PAC55A000 ACP 5 • BMS Integration (BACnet IP, Modbus TCP)	PAHCM5000 AHU Comm.Kit • Discharge air

Academic Institution Control Solution



Class Room

Automatically save energy in the absence of students

Central controls prevent students from arbitrary control

Lecture Hall

Schedule management according to academic plan

Maintenance Office

Integrated management of distributed buildings

Centralized management with multiple interfaces

Design Proposal

CLASS ROOM		LECTURE HALL		MAINTENANCE OFFICE	
Automatically save energy in the absence of students	Central controls prevent students from arbitrary control	Schedule management according to academic plan		Integrated management of distributed buildings	Centralized management with multiple interfaces
PTV5MA0 Human detection sensor					
PREMTB100 Wired remote controller		PACS5A000 AC Smart 5	PACP5A000 ACP 5	PACM5A000 AC Manager 5	
• 4.3 inch color LCD • Touch button		• BMS Integration (BACnet IP, Modbus TCP)	• BMS Integration (BACnet IP, Modbus TCP)		

Office Control Solution

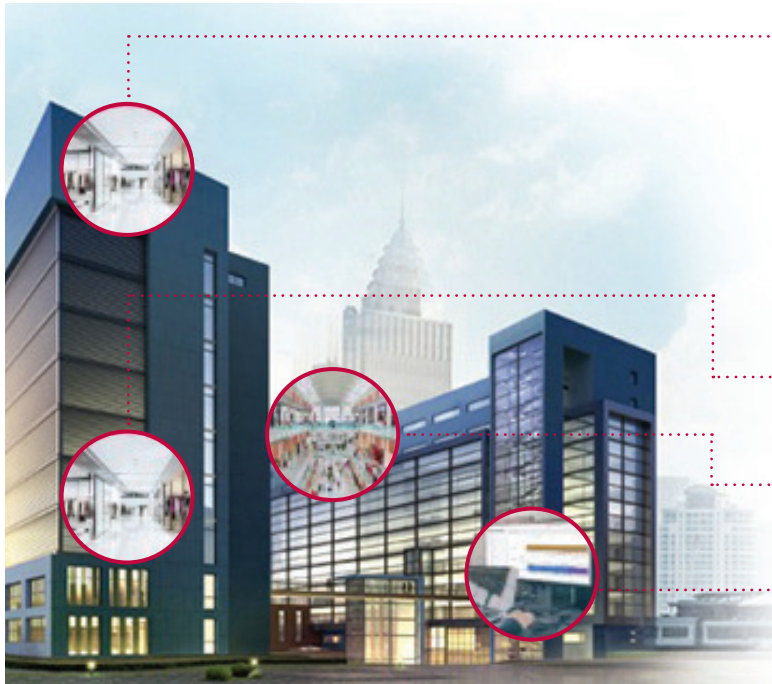

Maintenance Office

Energy savings and management throughout the building

Integrated management of HVAC with BMS system

Reduce costs by replacing BMS

Office Room

Reasonable power distribution to tenants

Server Room

24-hour backup management

Meeting Room

Energy savings based on occupancy detection

Design Proposal

MAINTENANCE OFFICE	OFFICE ROOM	SERVER ROOM	MEETING ROOM
<p>Energy savings and management throughout the building</p> <p>Integrated management of HVAC with BMS system</p> <p>Reduce costs by replacing BMS</p> <p>Target Forecasting</p> <p>PAC5A000 AC Smart 5</p> <ul style="list-style-type: none"> • BMS Integration (BACnet IP, Modbus TCP) <p>PAC5A000 ACP 5</p> <p>PMBUS00A Modbus RTU gateway</p> <p>PEXPMB000 ACS IO Module</p> <p>PEXP300 PEXP200 PEXP100 ACS IO Module</p>	<p>Reasonable power distribution to tenants</p> <p>PPWRDB000 PDI Standard (2 ports)</p> <ul style="list-style-type: none"> • Max. 128 IDU <p>PQNUD1S40 PDI Premium (8 ports)</p> <ul style="list-style-type: none"> • Max. 128 IDU 	<p>Main equipment 24 hours back up management</p> <p>PAC5A000 AC Smart 5</p> <ul style="list-style-type: none"> • BMS Integration (BACnet IP, Modbus TCP) <p>PAC5A000 ACP 5</p> <ul style="list-style-type: none"> • BMS Integration (BACnet IP, Modbus TCP) 	<p>Energy savings based on occupancy detection</p> <p>PTVSMAO Human detection sensor</p> <p>PREMTB100 Wired remote controller</p> <ul style="list-style-type: none"> • 4.3 inch color LCD • Touch button

Residential Control Solution



Home

Anytime, anywhere air conditioner control and access

Integrate systems for smart connectivity throughout

Bed Room





Use a familiar residential thermostat

Simple interlocking control by remote control

Apartment / Residence

Stable system operation

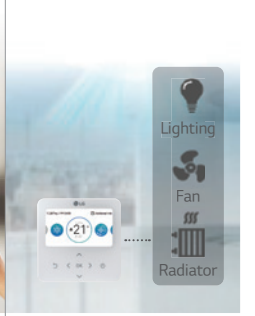
Design Proposal

HOME	BED ROOM	BED ROOM	APARTMENT
<p>Control your home air conditioner anytime, anywhere</p>	<p>Use a familiar residential thermostat</p>	<p>Simple interlocking control by remote control</p>	<p>Stable system operation when indoor unit power is lost</p>
			
<p>PWFMDD200 Wi-Fi modem</p>	<p>PDRYCB500 Modbus RTU (9,600bps)</p>	<p>PDRYCB320 8 contact point</p>	<p>PINPMB001 Multi-tenant Power Module</p>
<p>Function</p> <ul style="list-style-type: none"> • On / Off • Fan speed • Operation mode • Vane control • Reservation (Sleep, Weekly On / Off) • Error check 	<p>Function</p> <ul style="list-style-type: none"> • Operation • Indoor temperature • Error alarm • Set operation mode • Set temperature • Set fan speed 	<p>Input</p> <ul style="list-style-type: none"> • Universal Input • Operation On / Off • Thermo On / Off • Operation mode (Fan / Heat / Cool) • Fan speed (Low / Middle / High) <p>Output</p> <ul style="list-style-type: none"> • Operation On / Off status • Error alarm 	<p>Function</p> <ul style="list-style-type: none"> • EEV full close function



ACCESSORIES

294 ~ 315

MECHANICAL ACCESSORIES

PIPING ACCESSORIES



Cassette Panel

The Independent Vane Operation makes desired and comfortable air flow.



PT-QAGW0



PT-USC



PT-UAHGO, PT-TAHGO
PT-UPHGO, PT-TPHGO



PT-UAHWO, PT-TAHWO

Model Name & Applied Products

4 Way Cassette (Mini, 570x570)
PT-QAGW0

2 Way Cassette
PT-USC

1 Way Cassette (Grill Type)
PT-UAHGO / PT-TAHGO (Glossy)
PT-UAHWO / PT-TAHWO (Non-Glossy)

1 Way Cassette (Air Purification)
PT-UPHGO / PT-TPHGO (Glossy)

Key Features

- Independent vane operation uses separate motors, making it possible to control all 1, 2, and 4 vanes independently.
- The detachable corner design makes it easy to adjust the hanger during installation and to check for leakages in the drain pipe and refrigerant pipes.

Compact and Stylish Design

- Mini 4 way cassette panel adapted unibody shape and matching with into the ceiling.
- Panel size is fit into the ceiling tile.

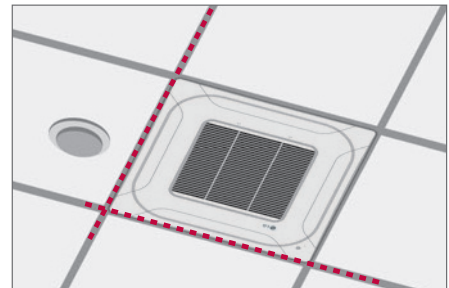
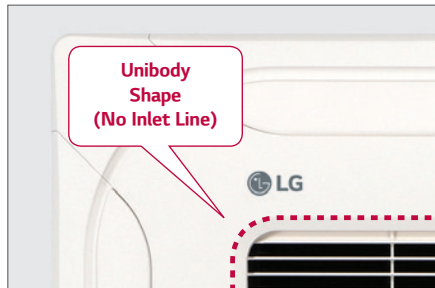

Specification

Model	Suction Type	Color (RAL)	Gloss	Weight (kg)	Dimension (mm)			Applied Model Capacity (kW)*					
					W	H	D	Single Split		Multi Split		Multi V	
								R32	R410A	R32	R410A	R32	R410A
4 Way	PT-QAGW0	White (RAL 9003)	X	2.9	620	35	620	2.5-5.0	2.5-5.0	1.5-5.3	1.5-5.3	1.6-6.2	1.6-6.2
2 Way	PT-USC	Morning Fog (RAL 9001)	X	4.7	1,100	28	690					2.8-7.1	2.8-7.1
1 Way	PT-UAHGO	White (RAL 9003)	O	3.9	1,160	34	500			2.6-3.5	2.6-3.5	2.2-3.6	2.2-3.6
	PT-TAHGO	White (RAL 9003)	O	4.8	1,480	34	500					5.6-7.1	5.6-7.1
	PT-UAHWO	White (RAL 9003)	X	3.3	1,100	34	500			2.6-3.5	2.6-3.5	2.2-3.6	2.2-3.6
	PT-TAHWO	White (RAL 9003)	X	4.5	1,420	34	500					5.6-7.1	5.6-7.1
	PT-UPHGO	White (RAL 9003)	O	4.1	1,160	34	500			2.6-3.5	2.6-3.5	2.2-3.6	2.2-3.6
	PT-TPHGO	White (RAL 9003)	O	4.9	1,480	34	500					5.6-7.1	5.6-7.1

* Based on cooling capacity
※ O : Applied, - : Not applied

Dual Vane Cassette Panel



Model Name
PT-AAGW0
PT-AFGW0

Key Features

Model	Function				
	Dual Vane	Wi-Fi	Floor Temperature Sensor	Air Purification	Human Detection Sensor
PT-AAGW0	0	Optional	Optional	X	Optional
PT-AFGW0	0	Optional	Optional	Optional (Dust Sensor, Tact Switch)	Optional

Specification

Model	Suction Type	Color (RAL)	Gloss	Weight (kg)	Dimension (mm)		
					W	H	D
PT-AAGW0	Grid	White (RAL 9003)	-	7.1	950	35	950
PT-AFGW0	Grid	White (RAL 9003)	-	7.5	950	35	950

Air Purification Kit

Model	Type	Image	Model name	Dielectric Dust collecting filter	Photocatalytic Deodorizing filter	HVPS	Ionizer
Air Purification Kit	4 Way		PTAHMP0	 0	0	0	0
	1 Way		PTAHTP0	 0	0	0	0
	Round		PTAHYP0	 0	0	0	X

Cassette Cover

Cover in case of exposed cassette installation.

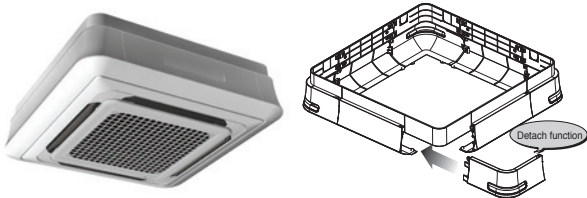

Model Name
PTDCA

Applied Products

4 Way Cassette (for chassis TP-B, TM-A)

Included Parts

- Cover A, Cover B
- Cover C, Cover D
- Screws
- Installation Manual

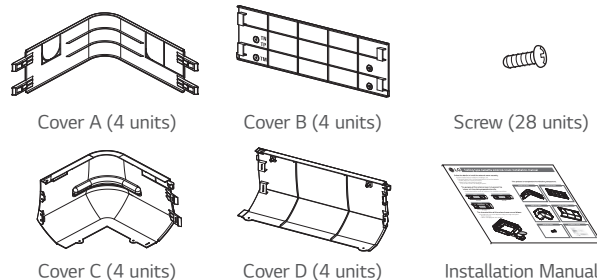

Key Features

- Specially designed for indoor unit
- Gives elegant looks
- Covers the side area of cassette
- Light weight

Specification

Model	Front Panel		Weight (kg)		Dimensions (mm)		
			NET	Gross	W	H	D
PTDCA	PT-AAGW0 / PT-AFGW0	TP-B	6.1	9.5	1,157	266	1,157
		TM-A	6.1	9.5	1,157	308	1,157

CO₂ Sensor

CO₂ sensor in ventilation system.

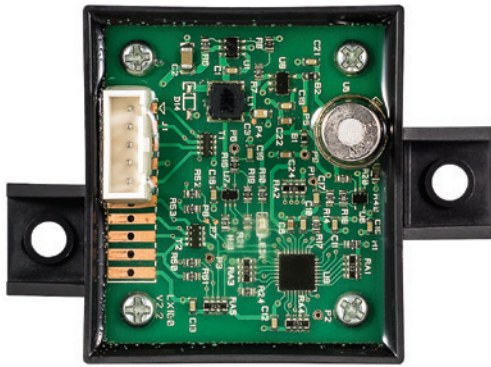

Model Name

AHCS100H0

Applied Products

LZ-H025GBA4
 LZ-H035GBA5 / LZ-H050GBA5
 LZ-H080GBA5 / LZ-H100GBA5
 LZ-H150GBA5 / LZ-H200GBA5

Applicable Products

LZ-H050GXN0 / LZ-H080GXN0
 LZ-H100GXN0 / LZ-H050GXH0
 LZ-H080GXH0 / LZ-H100GXH0

Key Features

Specification

- Applied Model : ERV (Embedded), ERV DX (Option)
- Supply voltage : DV12V ± 5%
- Output : 0.6 ~ 4.4V (Linear output, 240 ~ 1,760 ppm CO₂)
- Accuracy : ± 10% (2 days after installation)

Description

- The product is especially designed to detect CO₂.
- This model requires Standard III Wired Remote Controller for display.

Key Application

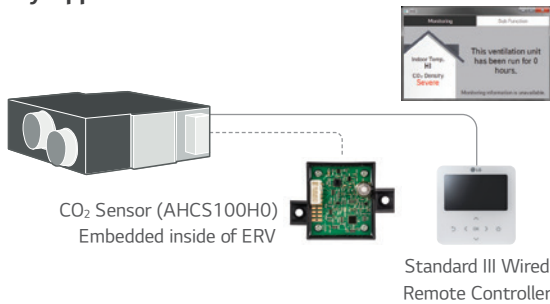

Dimensions (Unit : mm)

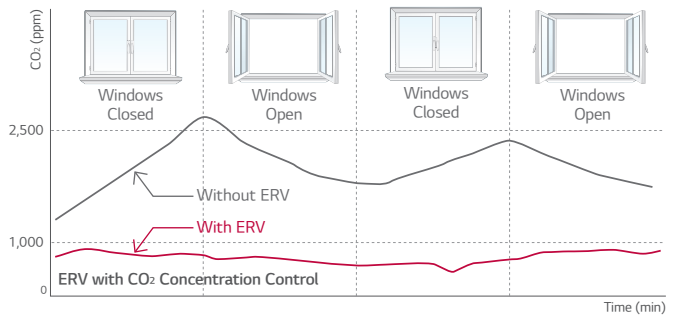
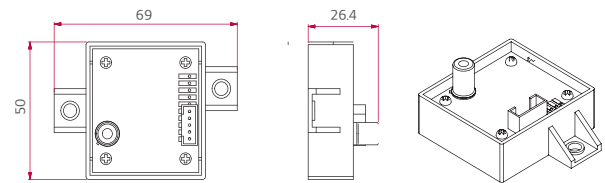

How to Install

1. Remove a screw on the service cover. Pull the service cover fixing bracket (①), then remove the service cover (②). Remove two elements (③) and two air filters (④).
 2. Install the sensor with two screws.
 3. Remove a screw, then remove the right side of element rail (⑤).
 4. Press the holder (⑥) into the hole to fix the CO₂ sensor cable (⑦).
 5. Connect the wire terminal to the CN-CO₂ port of PCB.
- ※ Airflow can be controlled by concentration of CO₂, after setting automatic operation mode at remote controller.
 ※ Use the screwdriver whose total length is less than 250mm.

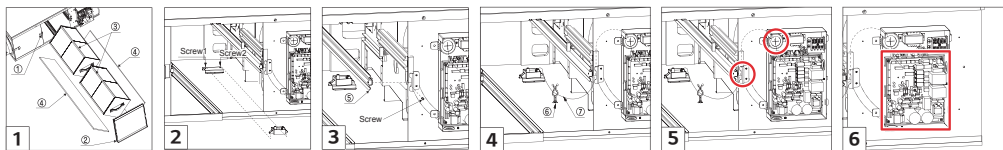

Human Detection Kit

Human Detection Kit ensures energy saving and controls wind direction.

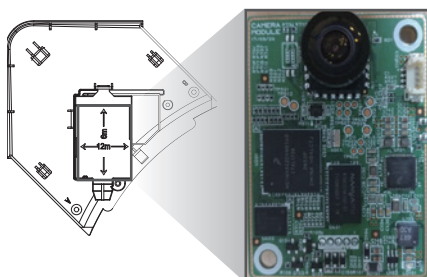

Model Name

PTVMA0

Applied Products

PT-AAGW0
 (For Dual Vane Cassette Panel)
 PT-AFGW0
 (For Dual Vane Cassette Panel)

Key Features

- Human Detection Control provides two functions. 'Saving Operation' for energy savings and 'Wind Direction Operation' for comfort.
- Detection Range : ~ height 4.2m
- Installation Height 2.7m → Detection area 12m x 6m
- Installation Height 3.2m → Detection area 15m x 8m
- Installation Height 4.2m → Detection area 18m x 9m

Refrigerant Leakage Detector

R410A refrigerant leakage detector ensures room safety.



Model Name

PRLDNVSO

Applied Products

- Multi V i
- Multi V 5
- Multi V IV Heat Pump & Heat Recovery
- Multi V Water 5

Key Features

- This detector senses refrigerant leakage when the refrigerant concentration exceeds 6,000ppm. (The green and red LED lights blink simultaneously.)
- Alarm is "on" when refrigerant leaks out more than 6,000ppm for 5 seconds. If it is reduced less than 6,000ppm for 5 seconds, alarm is "off".
- When the alarm of the refrigerant leak detector is switched on the user must ventilate the room until the alarm is disabled.
- The detector has to be installed inside the room and it should be installed 300 ~ 500mm above the floor.

Specification

Parts	Specifica tion	
Sensor	Rated Voltage (V)	DC 5.0 ± 5%
	Dimensions (W x H x D, mm)	31 x 44 x 20
	Weight (g)	22
	Detectable Refrigerant	R410A
	Detected concentration (ppm)	0 / 6,000 Alarm Off / On
	Operating temperature range (oC)	-10 ~ 50
	Preserved temperature range (oC)	-40 ~ 60
Connecting cable	Average power consumption (mA)	35
	Cable length (m)	10
Sensor protective cover	Dimensions of Front Plate (W x H x D, mm)	80 x 110 x 44.6
	Dimension of Backplate (W x H x D, mm)	80 x 110 x 6.5

This function available for ARU***L*5 and 4 (MULTI V i, MULTI V 5, MULTI V IV H/P, H/R model)

Included Parts

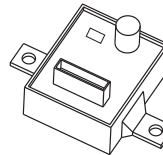

Sensor



Connecting Cable

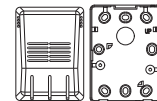

Sensor Protective Cover

Key Application

Refrigerant Leakage Detector has three application methods.

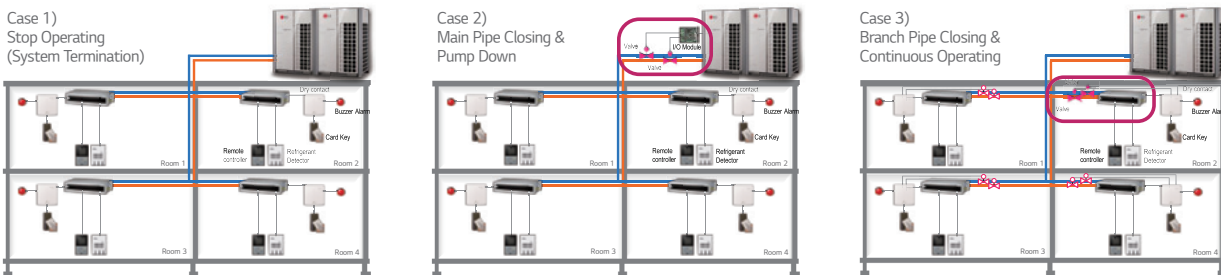

Accessory Specification (To realize the case 2 application)



I/O Module PVDSMN000



PRLDNVSO (Refrigerant leak detector)



[Optional / Field Supply] Automatic Ball Valve¹⁾



PDRYCB400 (Dry contact)



[Optional / Field Supply] Buzzer alarm for central control room (Direct connection - DC 30V, - 1A)



[Field Supply] Buzzer alarm for room



Central Control Devices

※ Necessary accessory

1) Please contact to subsidiary to get the recommended specification. (LG Electronic don't provide this accessory)

EEV KIT (for Indoor Unit)

MULTI V EEV KIT is specially designed to reduce noise and make comfort environment.



Model Name
PRGK024A0

Key Features

- Decreasing noise level of Multi V Indoor units and easy installation.

Key Application

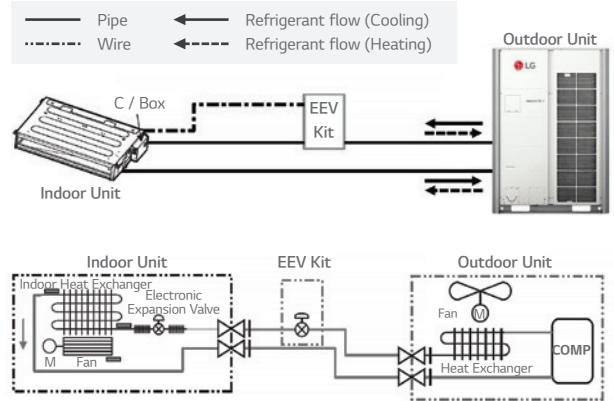

Applied Products

Indoor Unit	Model	Chassis	Applicable
Cassette	1 Way Cassette	TU	○
	2 Way Cassette	TT	N/A
		TS	○ (~5.6kW)
	4 Way Cassette	TR	○
		TQ	○ (~4.5kW)
		TP	N/A
		TN	N/A
Duct	High Sensible	TM	-
		BG	-
		BR	-
	High Static	B8	-
		M1	○ (~5.6kW)
	Middle Static	M2	-
		M3	-
		L1	○
	Low Static	L2	-
		L3	-
CE		○	
Etc	Floor Standing	CF	-
		VE	○
	Convertible	V1	-
		V2	-
	Ceiling Suspended	SJ	○
		SK	○
	Wall Mounted	SV	-
		SF	○
	Art Cool	QA	○
	Console	K2	-
Hydro kit	K3	-	

※ ○ : Applied, - : Not applied, N/A : Not Applicable

EEV Kit can be applied for the space which requires quiet environment and noise sensitive space.



Luxury Hotel



Villa



Executive office



Meeting room

Note : If you don't use EEV of same specification, Cooling (Heating) capacity could be decreased.

How to Install

Open Indoor unit's control box cover.

- ① Open fully indoor unit's EEV through vacuum mode of ODU setting.
- ② Detach the Indoor unit's EEV connector from PCB and then push the reset button of Outdoor unit's PCB.
- ③ After connecting indoor unit's EEV CONNECTOR, repeat the process ① & ②. Then, connect the EEV CONNECTOR of EEV KIT in PCB of indoor unit.
- ④ Finally connect the lead wire of the EEV Kit to the indoor unit's PCB.
- ⑤ Assemble the control box cover.

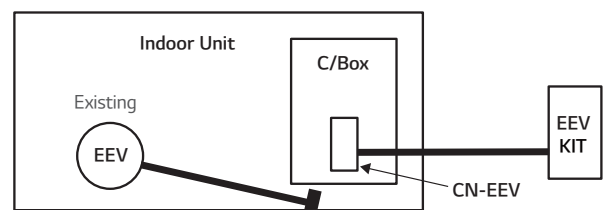

IR Receiver

IR RECEIVER can be connected to ceiling concealed duct and floor standing unit which the customer wants to control by wireless remote controller.



Model Name
PWLRVN000

Applied Products
Multi V Indoors (Ceiling Concealed Duct, Floor Standing Units)

Key Features

- Designed for wireless control
- Indication lamps (3 colors) and Self-diagnosis function

Key Application

Note : Do not install both the IR Receiver and Wired Remote Controller. This may cause malfunctions.

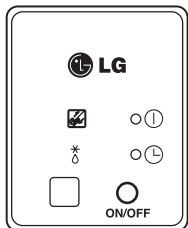

Operation of Indica tion Lamps

- ① Emergency Operation button : Turns the indoor unit on or off when remote controller is not working.
- ② Signal Detector : Receives the signal from remote controler.
- ③ Timer lamp (Green) : Lights up during the timer operation.
- ④ Hotstart lamp (Orange) : Lights up during the pre-heating operation, defrost operation as well as latent heat removal operation in heat mode. Available only for the heat pump models, not cooling only models.
- ⑤ System On / Off lamp (Red) : Lights up during system controller operation.
- ⑥ Filter Sign lamp (Green) : Lights up after 2,400 hours from the time of first power on operation.

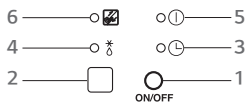

Signal Receiver

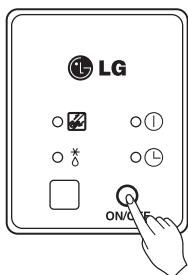

Test Run Mode

After installing the product, you must run a Test Run mode. Press the Emergency Operation button for 5 seconds, until the LED flickers. Then the indoor unit, duct runs cooling mode for 18 minutes, where the setting temperature is 18°C and the fan speed is high.

Multi-tenant Power Module

System operation is stable when indoor unit power is lost.



Model Name
PINPMB001

Applied Products
Multi V Indoor Units

Key Features

- Multi-tenant site IDUs are powered separately, some of IDU power is gone by each tenant. In this case, system operation is not stable without Multi-tenant Power Module.
- This module power each EEV for stabilizing system operation.

Installation Scene

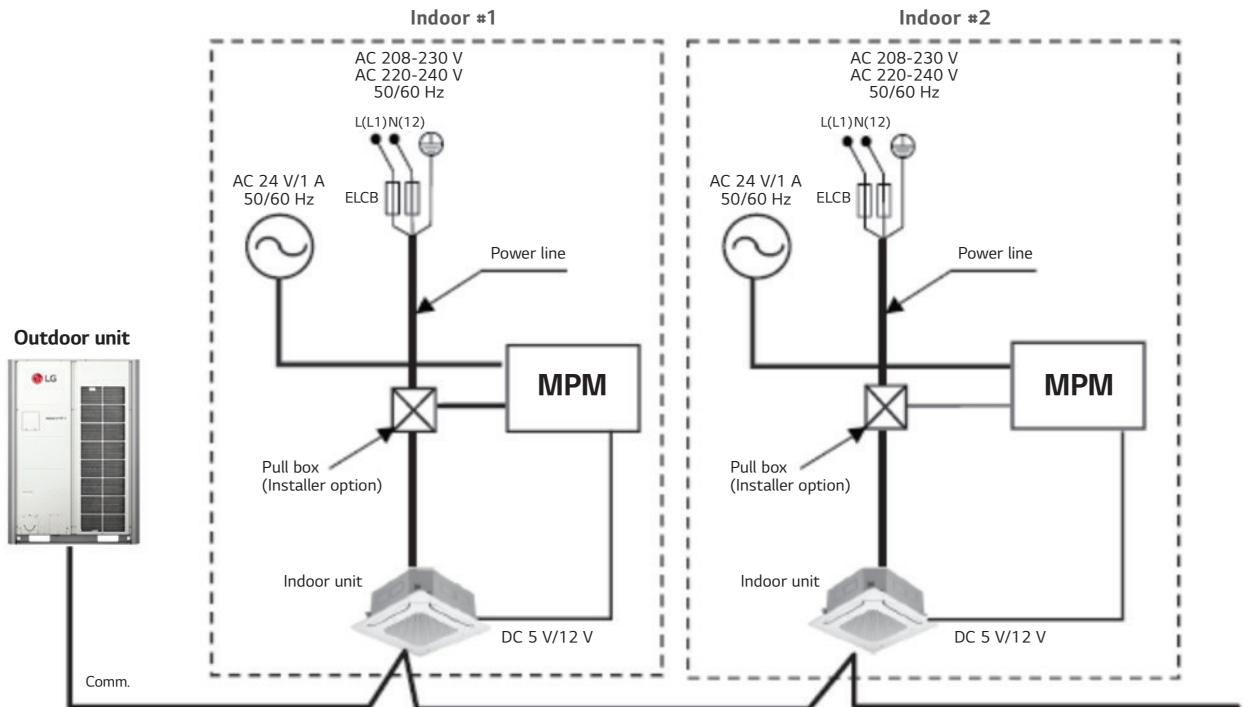

※ When Multi-tenant Power Module is adopted, CN-EXT must used for it. Instead of being used CN-EXT, PDRYCB000 (220Vac input) / PDRYCB100 (24Vac Input) Module are being used for Single contact.

Auxiliary Heater Relay Kit

Providing an efficient way to add auxiliary heat.



Model Name
PRARS1

Applied Products
Wall Mounted, Art Cool Mirror, Art Cool Gallery

Model Name
PRARH1

Applied Products
1, 2, 4 Way Ceiling Cassette, High Static Ducted,
Low Static Ducted, Ceiling Suspended

Key Features

- Provides two stages of auxiliary heat for indoor unit.
- Provides ability to use the two stage auxiliary heater as the primary or secondary heating source.

Included Parts

Model	PRARH1			
Item	Auxiliary Heater Relay Kit	Screw	Insulation	Installation Manual
Q'ty	1	2	2	1
Figure				

Model	PRARS1			
Item	Auxiliary Heater Relay Kit	Screw	Insulation	Installation Manual
Q'ty	1	2	2	1
Figure				

Key Application

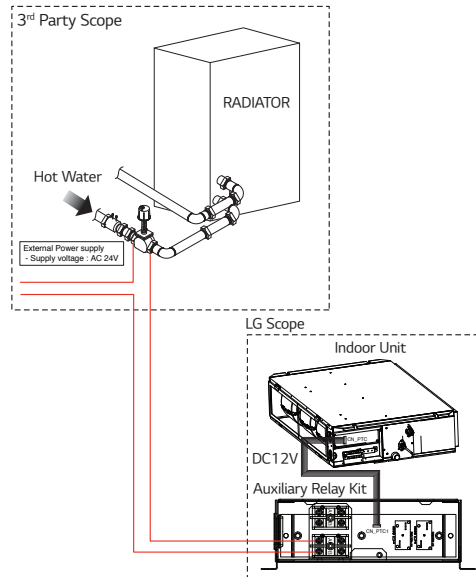

How to Install

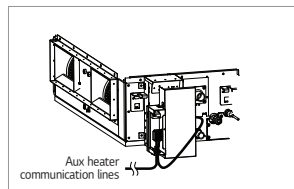

High Static Ducted

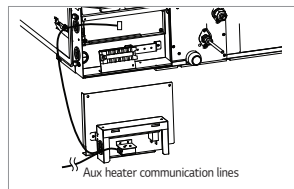

Low Static Ducted

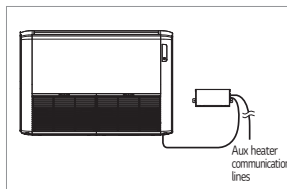

Ceiling Suspended

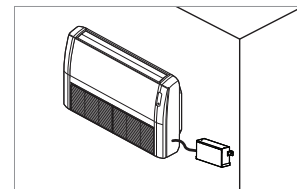

Wall Mounted

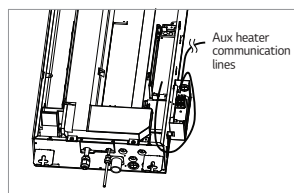

1 Way Cassette

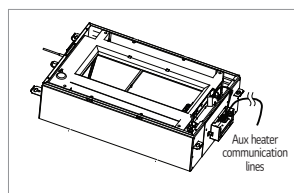

2 Way Cassette

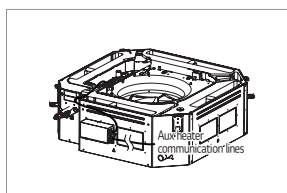

4 Way Cassette

Heat Recovery

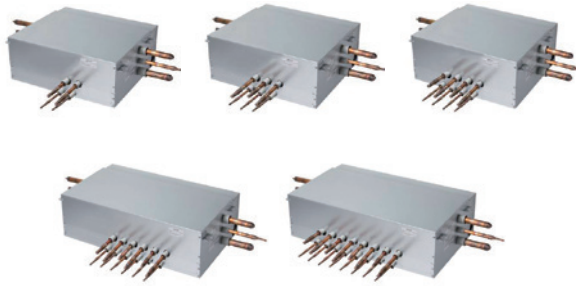

Model Name

- PRHR023 (2 Branch Unit)
- PRHR033 (3 Branch Unit)
- PRHR043 (4 Branch Unit)
- PRHR063 (6 Branch Unit)
- PRHR083 (8 Branch Unit)

Applied Products

- Multi V i
- Multi V 5
- Multi V IV
- Multi V Water 5

Key Features

- Max. 64 indoor units can be connected. (Max. 8 indoor units per branch)
- It is easy to install due to the automatic search algorithm for piping detection.
- Subcooling cycle in HR unit makes the system efficiency maximum.

Connection Capacity

Maximum number of connectable indoor units :
64 IDUs / HR unit (in case of 8 ports model)

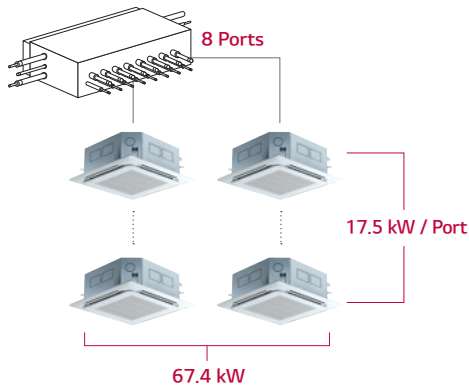

Flexible Connection

Series connection can be installed without pipes crossing.

New

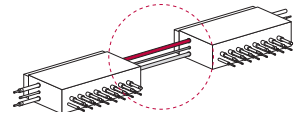

Considering the direction for Indoor units and SVC port, connection for reverse direction makes much easier

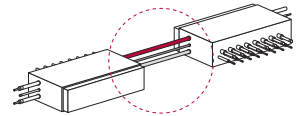

Reduce Noise

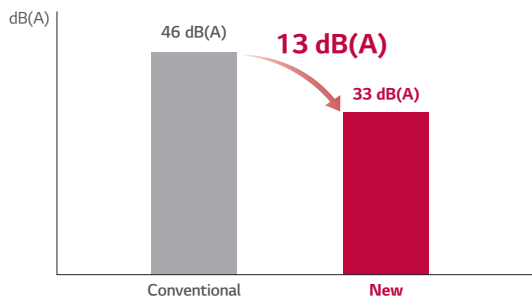

Test Condition (ISO Standard)

- Temp. : (Cooling) 27°C DB / 19°C WB, 35°C DB / 24°C WB
(Heating) 20°C DB / 15°C WB, 7°C DB / 6°C WB
- Operating : cooling → heating switching operation

Included Parts



- HR unit (1EA)
- Hanging bolts M10 or M8 (4EA)
- Nut M8 or M10 (8EA)
- Washers M10 (8EA)
- Reducers

Specification

Model		PRHR023	PRHR033	PRHR043	PRHR063	PRHR083		
Number of Branch	EA	2	3	4	6	8		
Maximum Connectable Capacity of Indoor Units (Per branch / unit)	kW	17.5 / 35	17.5 / 52.5	17.5 / 67.4	17.5 / 67.4	17.5 / 67.4		
Maximum Number of Connectable Indoor Units Per Branch	EA	8	8	8	8	8		
Nominal Input	Cooling	kW	0.040	0.040	0.040	0.076	0.076	
	Heating	kW	0.038	0.038	0.038	0.072	0.072	
Net. Weight	kg	18.5	20.3	22.0	28.3	31.8		
Dimensions (W x H x D)	mm	786 x 218 x 657	786 x 218 x 657	786 x 218 x 657	1,113 x 218 x 657	1,113 x 218 x 657		
Piping Connections	Indoor Unit	Liquid	mm (inch)	9.52 (3/8)	9.52 (3/8)	9.52 (3/8)	9.52 (3/8)	9.52 (3/8)
		Gas	mm (inch)	15.88 (5/8)	15.88 (5/8)	15.88 (5/8)	15.88 (5/8)	15.88 (5/8)
	Outdoor Unit	Liquid	mm (inch)	9.52 (3/8)	12.7 (1/2)	15.88 (5/8)	15.88 (5/8)	15.88 (5/8)
		Low Pressure	mm (inch)	22.2 (7/8)	28.58 (11/8)	28.58 (11/8)	28.58 (11/8)	28.58 (11/8)
		High Pressure	mm (inch)	19.05 (3/4)	22.2 (7/8)	22.2 (7/8)	22.2 (7/8)	22.2 (7/8)
Power Supply	Ø, V, Hz	1, 220-240, 50 1, 220, 60	1, 220-240, 50 1, 220, 60	1, 220-240, 50 1, 220, 60	1, 220-240, 50 1, 220, 60	1, 220-240, 50 1, 220, 60		

Reducers for Indoor Unit and HR Unit

(Unit : mm)

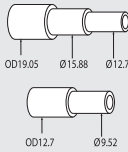
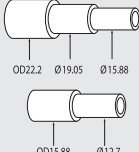
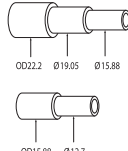
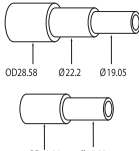
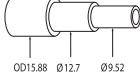
Model	Liquid	High Pressure	Low Pressure
Indoor unit reducer			
PRHR023			
HR unit reducer			
PRHR033 PRHR043 PRHR063 PRHR083			

Y Branch and Header Branch

For refrigerant distribution of indoor units.



Model Name

Refer to specifications

Applied Products

- Multi V i
- Multi V 5
- Multi V IV
- Multi V III, Multi V Plus II, Multi V Plus
- Multi V S
- Multi V Water 5
- Multi V Water IV
- Multi V Water II
- Multi V Water S

Key Features

- Various Y Branch pipe of different capacities make MULTI V installation much easier
- Y Branch and header branch for both gas and liquid are provided.
- Insulation material is also provided for covering the branches.

Key Application

Heat Pump System

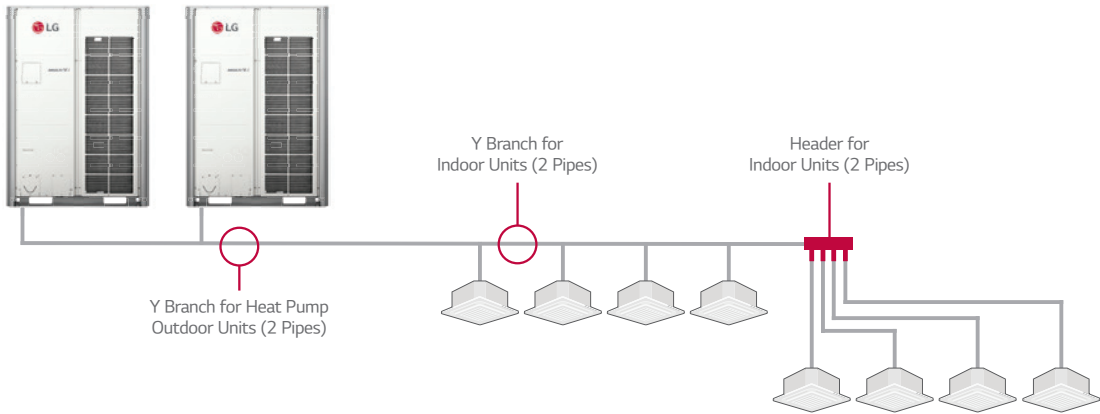

Heat Recovery System

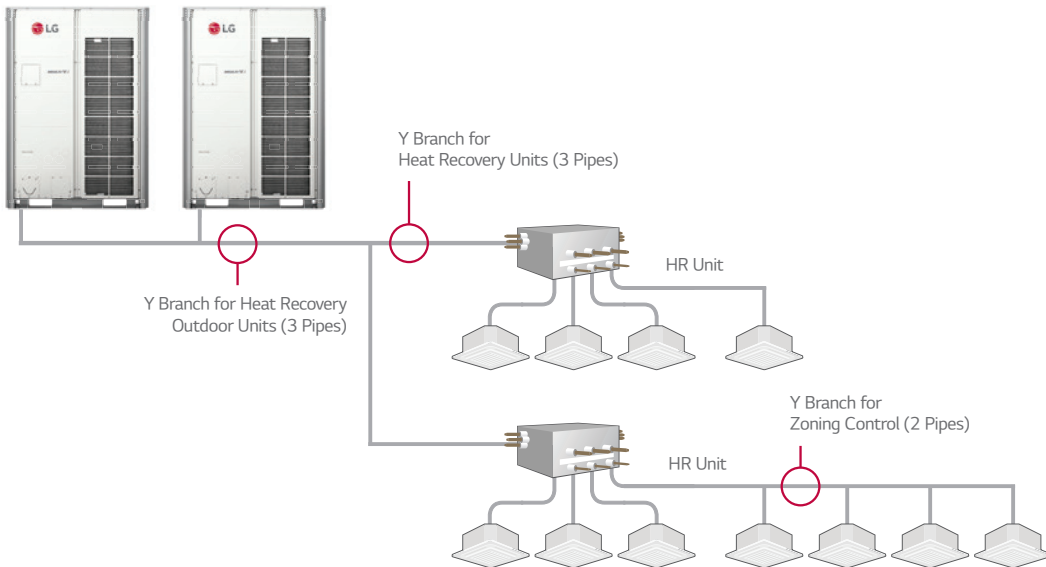

Specification
Header Branch
R410A

(Unit : mm)

Model	Gas Pipe	Liquid Pipe
ARBL054 (4 Branch)		
ARBL057 (7 Branch)		
ARBL104 (4 Branch)		
ARBL107 (7 Branch)		
ARBL1010 (10 Branch)		
ARBL2010 (10 Branch)		

Piping Accessories

Y Branch pipe for connection of outdoor units.

Specification

Heat Pump

R410A MULTI V i, MULTI V 5, MULTI V IV, MULTI V III, MULTI V WATER 5, MULTI V WATER IV, MULTI V WATER II

(Unit : mm)

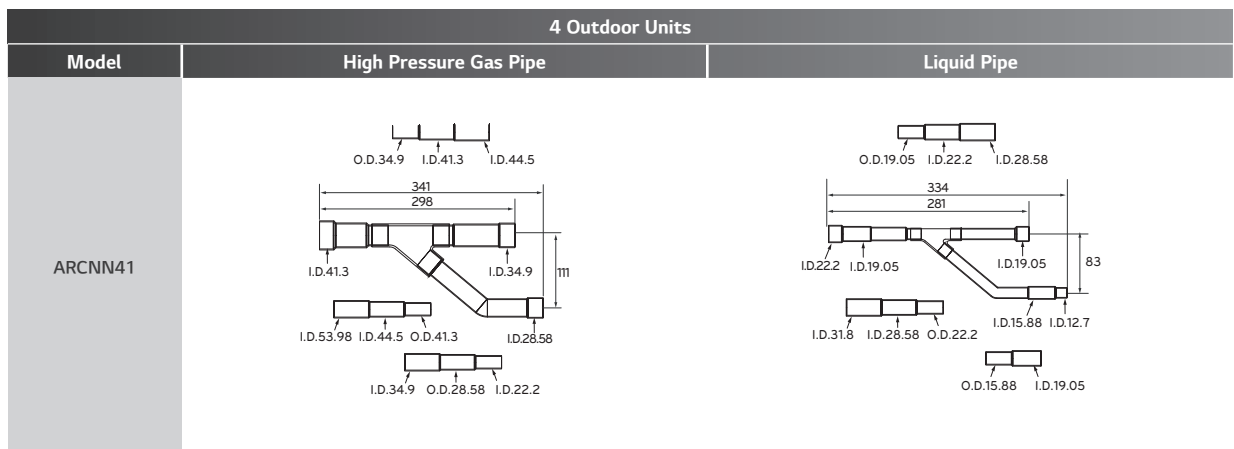
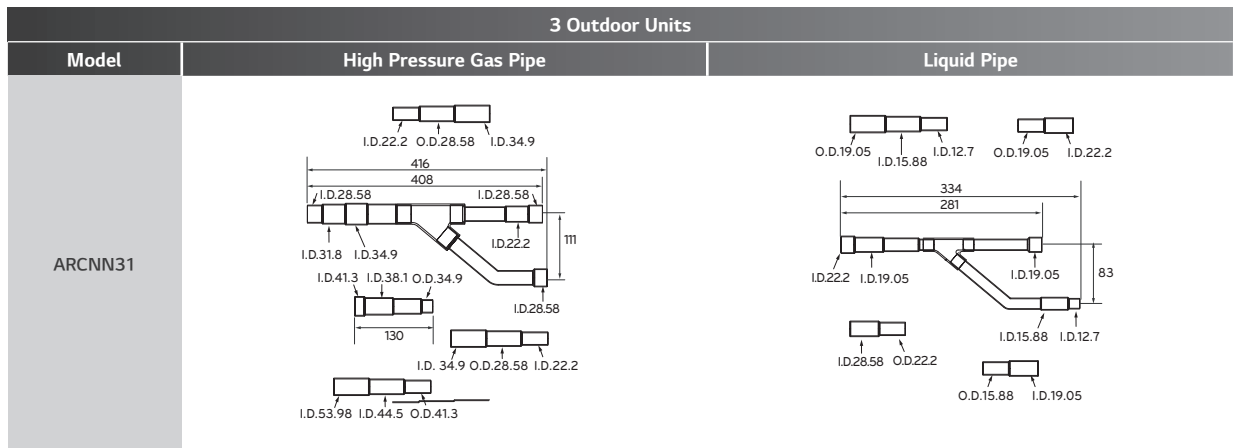
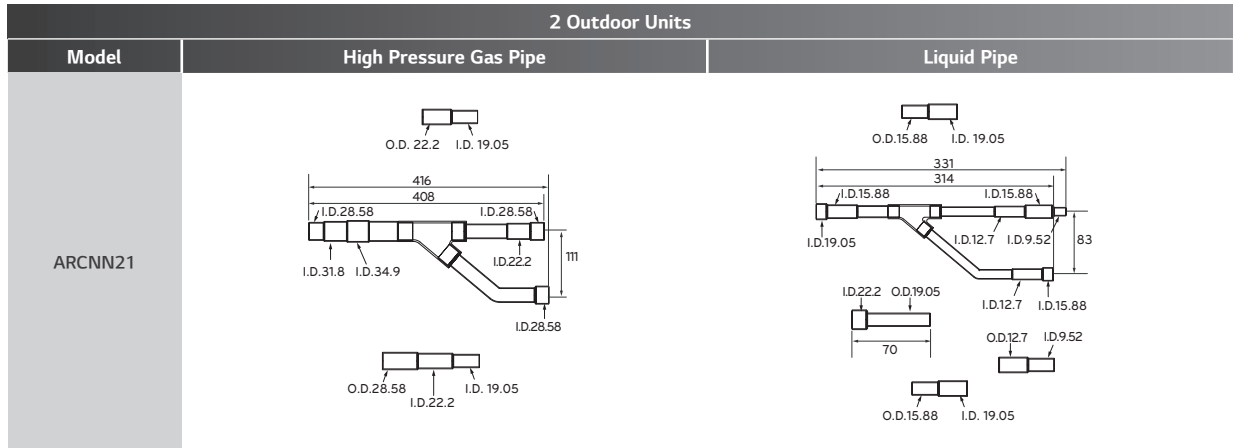

Specification

Heat Recovery

R410A

MULTI V i, MULTI V 5, MULTI V IV Heat Recovery, MULTI V III Heat Recovery, MULTI V WATER 5, MULTI V WATER IV Heat Recovery, MULTI V WATER II Heat Recovery

(Unit : mm)

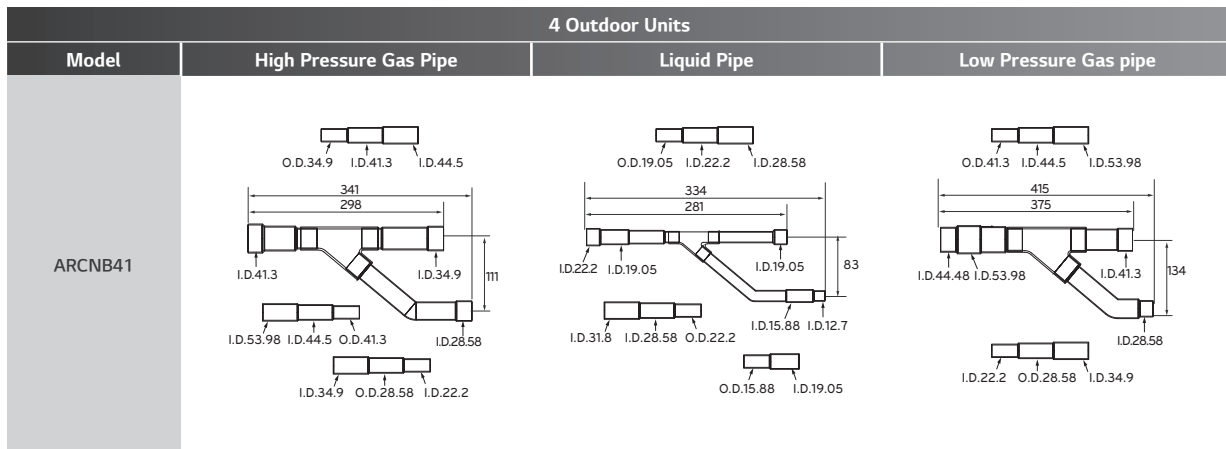
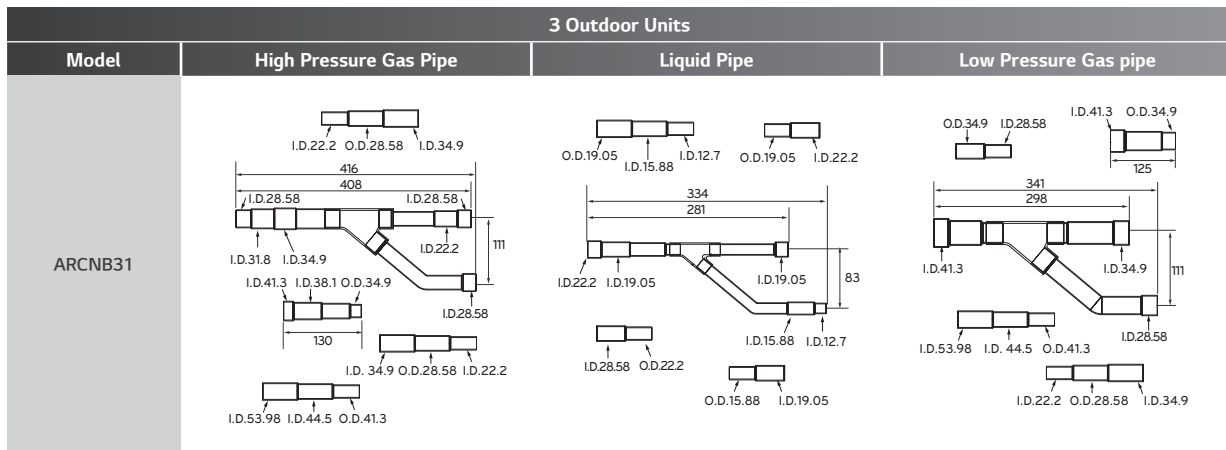
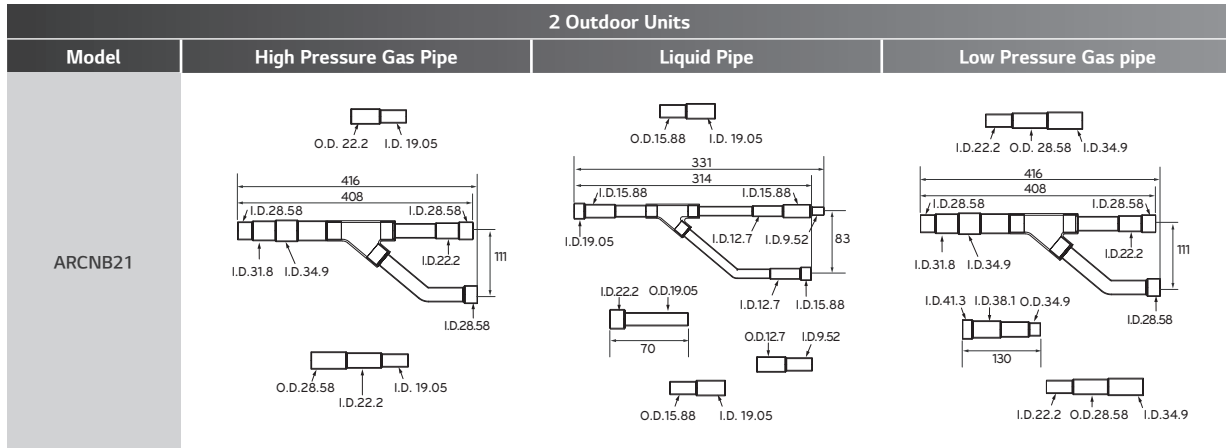

Piping Accessories

Y Branch pipe for connection of outdoor units.

Specification

Heat Pump, Heat Recovery Zone Control

R410A MULTI V i, MULTI V 5, MULTI V IV, MULTI V III, MULTI V PLUS II, MULTI V PLUS, MULTI V S, MULTI V MINI, MULTI V SPACE II, MULTI V WATER 5, MULTI V WATER IV, MULTI V WATER S, MULTI V WATER II

(Unit : mm)

Model	Gas Pipe	Liquid Pipe
ARBLN01621		
ARBLN03321		
ARBLN07121		
ARBLN14521		
ARBLN23220		

Specification

Heat Recovery

R410A

MULTI V i, MULTI V 5, MULTI V IV Heat Recovery, MULTI V III Heat Recovery, MULTI V WATER 5, MULTI V WATER IV Heat Recovery, MULTI V WATER II Heat Recovery

(Unit : mm)

Model	High Pressure Gas Pipe	Liquid Pipe	Low Pressure Gas Pipe
ARBLB01621			
ARBLB03321			
ARBLB07121			
ARBLB14521			

Model	High Pressure Gas Pipe	Liquid Pipe	Low Pressure Gas Pipe
ARBLB23220			

Refrigerant Charging Kit

Recharging refrigerant after a pump down or when refrigerant is either insufficient or excessive.

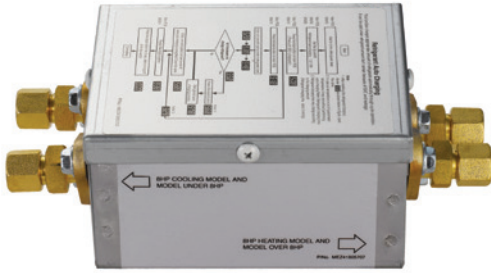

Model Name
PRAC1

Applied Products

- MULTI V i
- MULTI V 5
- MULTI V IV Heat Pump
- MULTI V IV Heat Recovery
- MULTI V III Heat Pump
- MULTI V III Heat Recovery
- MULTI V PLUS II
- MULTI V SYNC II

How to Use

- Arrange manifold, capillary assembly, refrigerant vessel and scale.
- Connect manifold to the gas pipe service valve of outdoor unit as shown in the figure.
- Connect manifold and capillary tube. Use designated capillary assembly only.
If designated capillary assembly isn't used, the system may get damaged.
- Connect capillary and refrigerant vessel
- Purge hose and manifold
- After "56B" is displayed, open the valve and charge the refrigerant.

Key Application

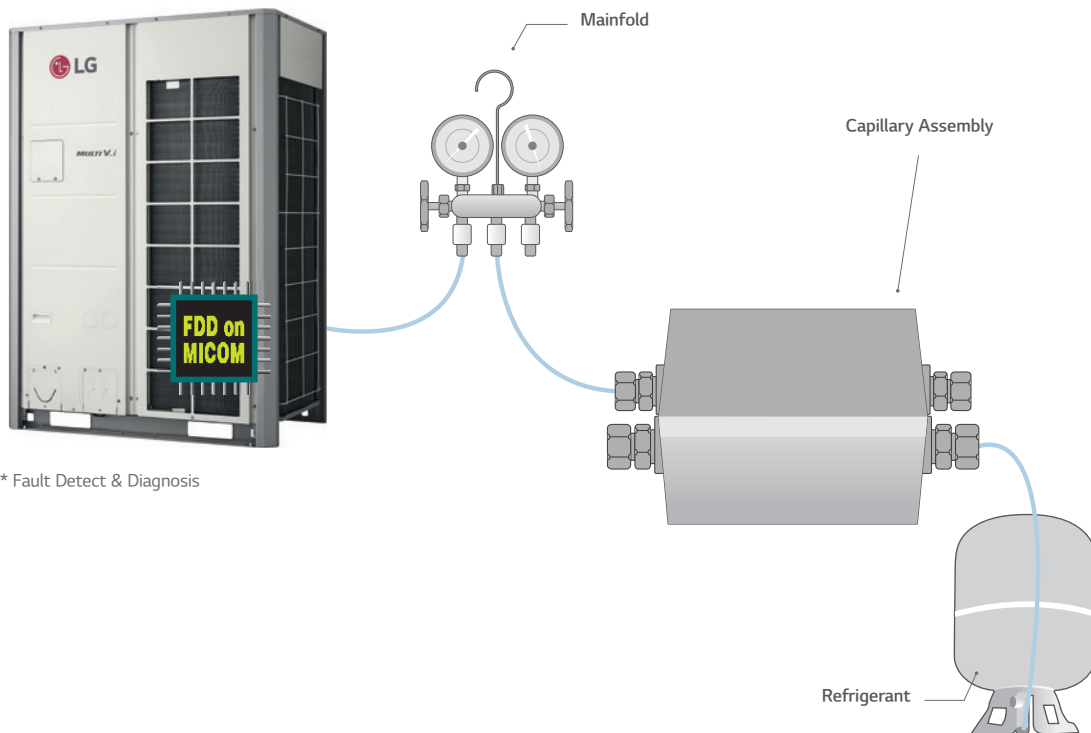

* Fault Detect & Diagnosis

Drain Hose

Easy drain installation.

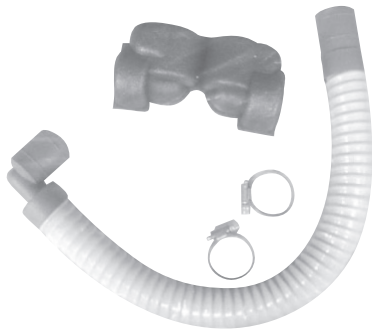

Model Name

- PHDHA05T
- PHDHA07T
- PHDHA05B
- PHDHA07B

Applied Products

Multi V Indoor units

Key Features

- It reduces the installation time by over 40% with elbow-less drain hose.
- Drain pump covers maximum 700mm high, featuring easy piping installation.

Key Application

- Ceiling Mounted Cassette and Ceiling Concealed Duct. (Refer to PDB for applicable model)

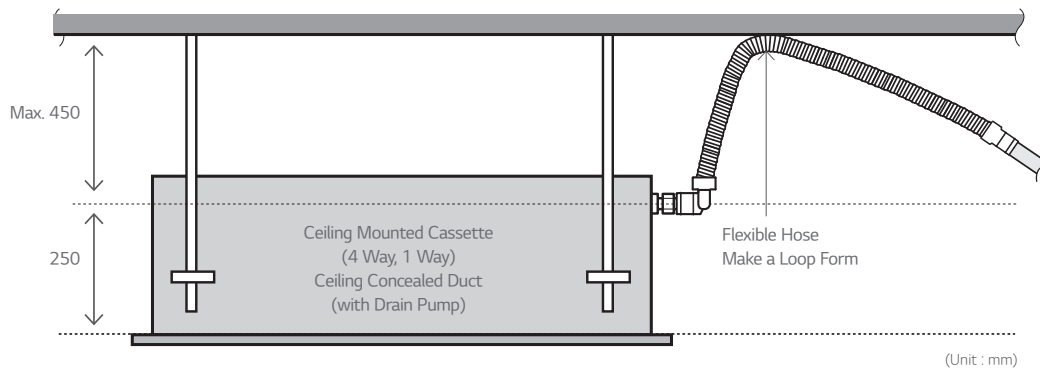

Specification

Model	Length	Quantity
PHDHA05T	500mm	30EA
PHDHA07T	700mm	30EA
PHDHA05B	500mm	5EA
PHDHA07B	700mm	5EA

Stopper Valves



Model Name

- PRVT120 (Under 12.7mm)
- PMVT780 (Under 22.2mm)
- PMVT980 (Under 28.58mm)

Key Features

- This unit can be applied for the additional indoor unit's installation.
- This unit can be applied for each indoor unit's service.

Specification

Model	Specification
PRVT120	
PRVT780	
PRVT980	

How to Install

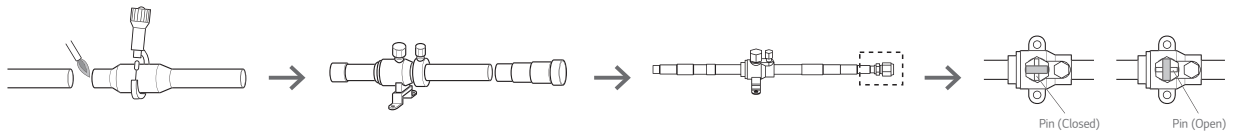

1. Cut the inlet side of the connector, and weld the pipe

2. If installing additional indoor units, the outlet side connector should be cut according to installation pipe

3. When installing a stopper valve, the flare part should be facing towards additional indoor unit.

4. When installing an additional indoor unit, the SVC valve should be in closed state.

※ When welding, service valve should be wrapped by wet cloth.

Application

(Room 3 & 4 : in use / Room 1 & 2 : need to install indoor units)

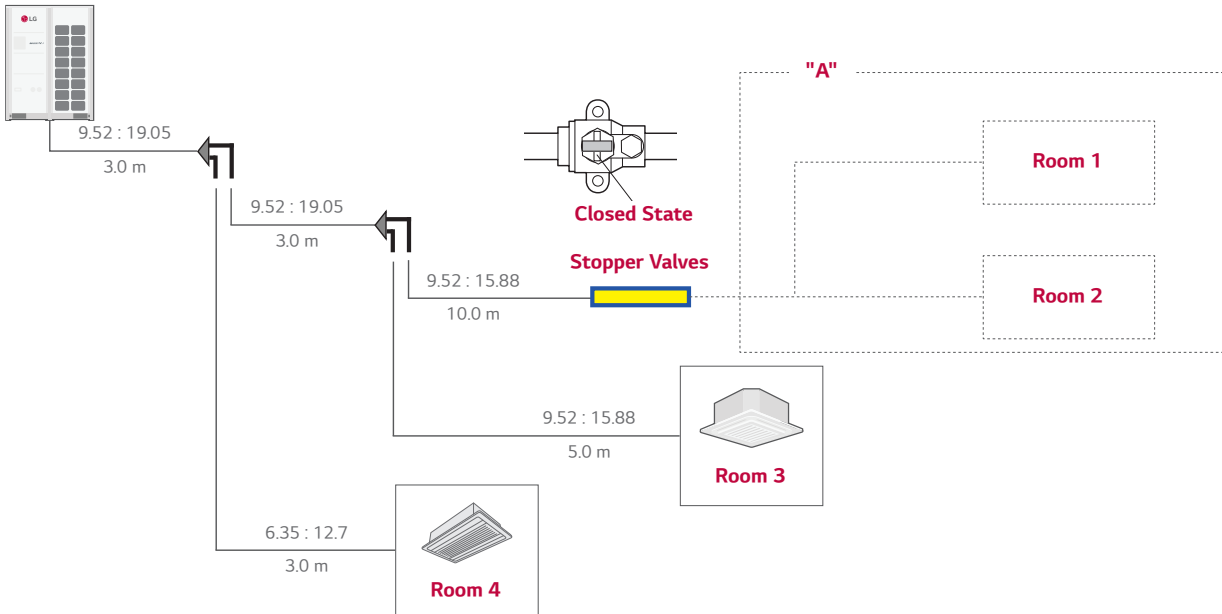

- In case of installation of additional indoor unit, refrigerant of used indoor unit must be discharged. (Room 3 & Room 4)
- If stopper valve is already installed, you can install additional indoor unit without refrigerant loss from the entire system.
- After installation of additional indoor unit, you just need refrigerant charging for "A" section.
- Then, open the Stopper Valve.

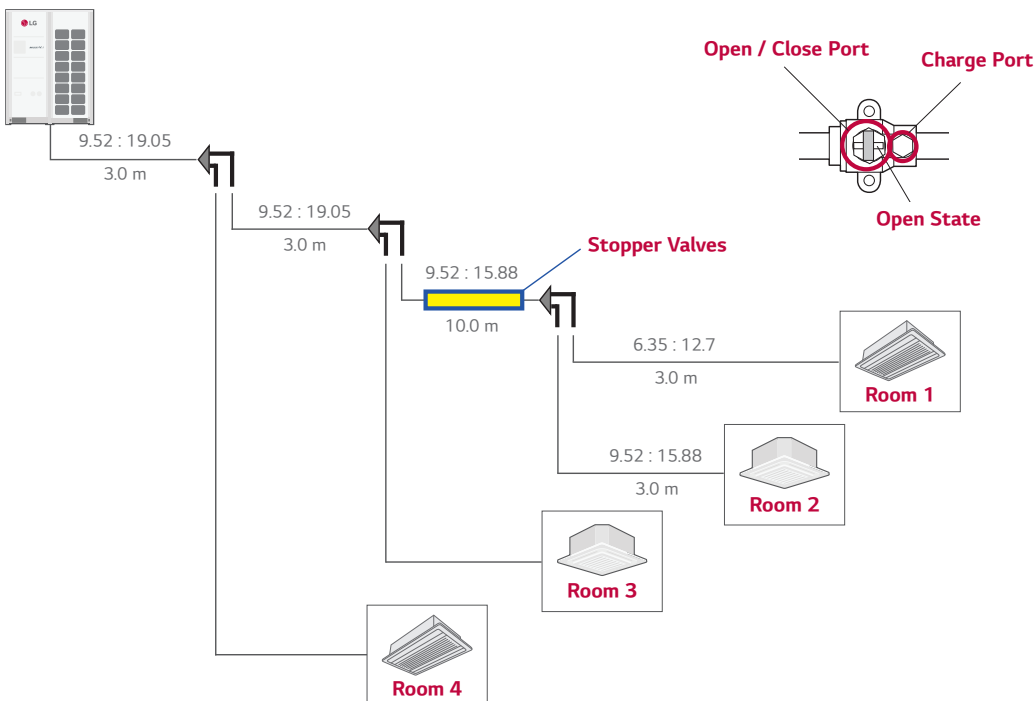



LG Electronics

<http://www.lg.com>

<http://partner.lge.com>

In view of the fact that, despite LG Electronics Magyar Kft's careful procedures regarding the properties and technical suitability of individual products, misunderstandings or typos may occur regardless of the scope of the information contained in this catalog, we ask that you always inform yourself about the individual properties of the product before purchasing, and in order to obtain any additional information about our products on our website www.lg.com or on our customer service phone number that can be called with a local tariff. Certain features will be available after installing updates that become available later. Due to the end of their support, some functions may become unavailable due to the decision of third-party developers/right holders, for which LG Electronics Magyar Kft. assumes no responsibility. The availability of the products in the catalog may vary by point of sale. Hungarian customer service: 06-1-54-54-054.

Copyright © 2023 LG Electronics. All rights reserved.

Distributed by